



**Before returning this product
to the store of purchase**

Contact Dee Zee if you experience the following problems:

- Missing Parts
- Installation Problems/Questions
- Warranty Questions

1.800.779.2102

Hours of operation: 8am - 5pm CST, Mon-Friday

Review complete warranty policy and register your product at:

www.deezee.com



Dee Zee Toolbox Installation Instructions

Congratulations on your purchase of a quality Dee Zee product. Dee Zee is recognized as having the highest quality running boards and accessories on the market today. We have earned this reputation by offering our customers a product they can be proud to place on their vehicles. Dee Zee meets all the criteria of manufacturing a custom-fit product which guarantees it to be the easiest product to install.

Note: Please take time to read all of the instructions before beginning this installation.

Warning! If it is necessary to drill any holes into the vehicle, Dee Zee recommends putting a sealant or rust inhibitor around all holes drilled into the body of the vehicle.

Cleaning Instructions: To maintain the bright finish of your Dee Zee Stainless Steel Toolbox, clean with a mild detergent and then apply a high grade automotive type wax.

If you should happen to have any questions with this product or you have an installation question, please feel free to call us at:

1-800-779-8222

If you would like to find out more information on Dee Zee's products please feel free to visit our website at:

WWW.DEEZEE.COM

Chest Tool Box Installation Instructions

Chest Toolbox: _____

Toolbox lid design may vary from picture with different toolbox models.

La conception de couvercle de boîte à outils peut changer de l'image avec différents modèles de boîte à outils.

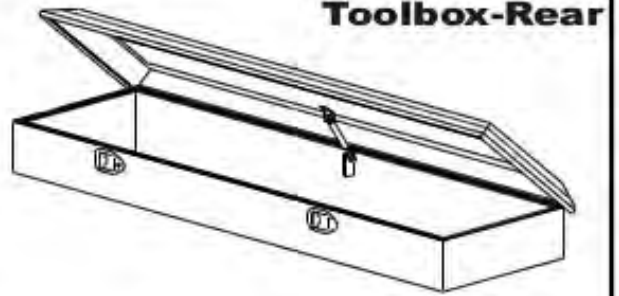
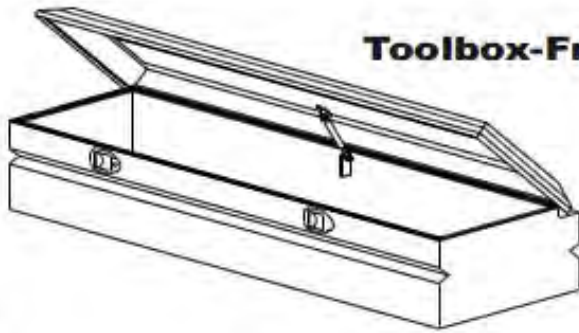

A

X1

B
1/4 x 1" Sheet
Metal Screw
X4

C
Foam Tape
X2

Tools Required:

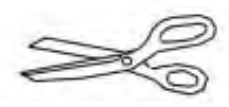
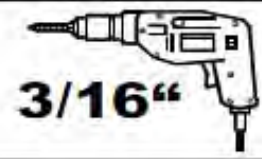

1
Peel backing off of foam tape (C).

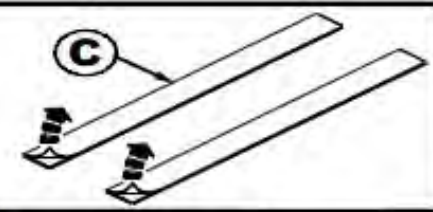

2 Place foam gasket (C) onto the bottom of toolbox (A). Trim foam gasket (C) so that it is flush with the ends of toolbox (A).

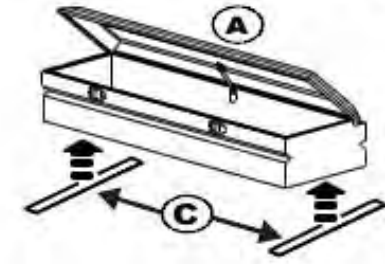
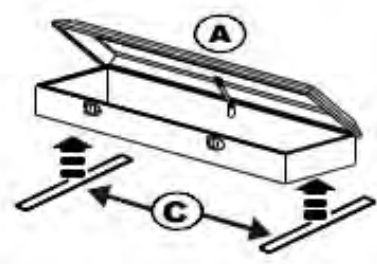
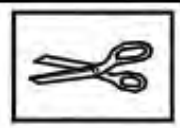

3



Place toolbox (A) into the back of your pickup truck bed.

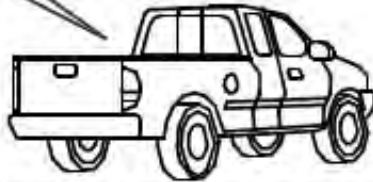

4

Locate the toolbox (A) in the pickup truck bed and then mark four hole locations in the bottom of toolbox (A). Drill a 3/16" hole at each marked hole location.

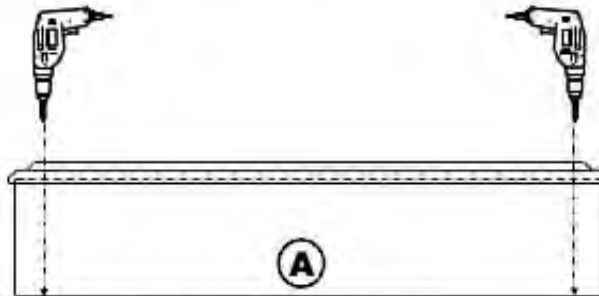

5

Attach toolbox (A) to the pickup truck bed using 1/4 x 1" sheet metal screws (B). Tighten them into place using a 3/8" wrench / or socket.

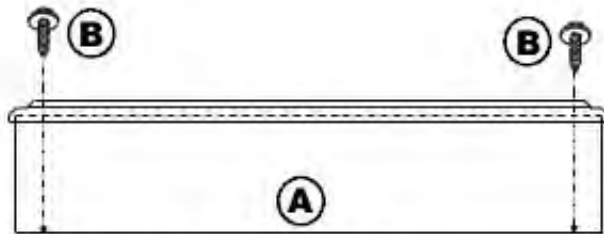

MAINTENANCE INSTRUCTIONS: All locks, latches, latching rods, and hinges should be lubricated regularly to assure smooth and proper operation for the life of the toolbox.

INSTRUCTIONS D'Entretien: Toutes les serrures, verrous, verrouillant des tiges, et des charnières devraient être lubrifiées régulièrement pour assurer l'exécution sans heurt et appropriée pendant la vie de la boîte à outils.

Toolbox Paddle Latch Assembly

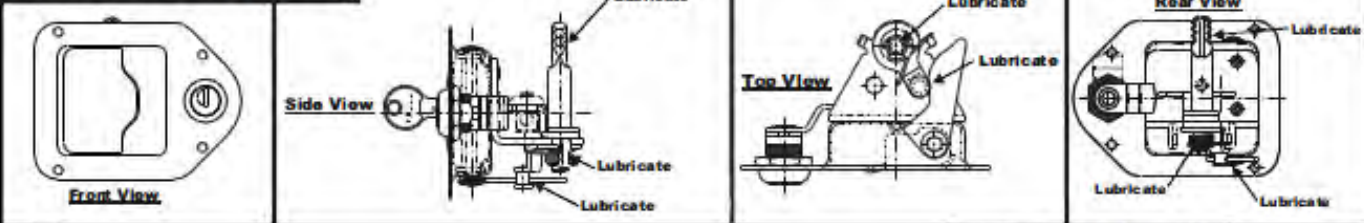

Toolbox Catch Assembly

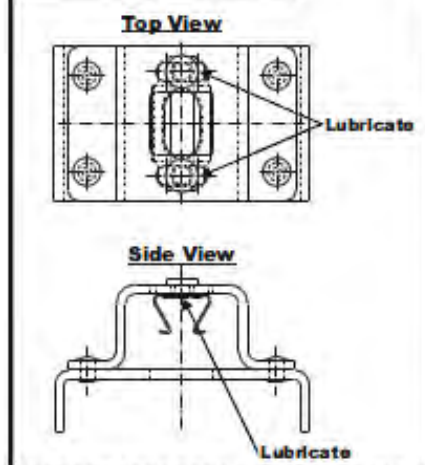

Ever lose your keys? Save Yourself Time and Trouble?

Order some extra keys now and have them when you need them. Please fill out and mail this portion to us. We'll send you a couple of extra keys for your Tool Box for just \$11.00 (American).

Name: _____

Day Phone: _____ - _____ - _____

Address: _____

Method of Payment:
 Cash, Check, or Money Order
 Master Card
 Visa

City, State, Zip: _____

Expiration Date: _____

KEY and LOCK#: _____

Card Number: _____

Please mail form and payment to : Dee Zee, Inc.
 OR P.O. Box 3090
 Fax to: 515-265-7926 Des Moines, IA 50316

CLEANING INSTRUCTIONS: To maintain the luster of your tool box, use a mild detergent.

**Locks are provided as a deterrent to inadvertent opening or easy access to the contents of your toolbox. Contents stored in the toolbox are the responsibility of the user.

After drilling, it is recommended that a sealant or rust inhibitor be placed around all holes drilled into the body panel of the vehicle.

If you should incur any problems with the installation of this product, please feel free to call us at 1-800-779-8222. So that we may better serve you when you call, please have the W/O#, SEQUENCE#, and the DATE from the label on the outside of the box.

Replacement Parts for Toolbox

Toolbox Hook-Paddle Latch Assembly			
			
Toolbox Hook-Catch Assembly		C-Channel Extrusion Part Number: B 1602	Rotary Plate - Adjustable Latch Part Number: B 1601
			
		1/4-20 Threaded Stud Part Number: PN 810	1/4-20 Flange Locknut Zinc Part Number: PN 178
			
			1/4-20 Nylon Locknut Ultra Part Number: PN 341B
			
			Nylon Standoff Part Number: PN 860
			
Pushbutton - Blue Series			
Spacer Brace for Push Button Part Number: B 1623	Adjustable Latch Part Number: B 1610	Carburetor Clip 7R Part Number: LCC-2	Mounting Bracket Part Number: B 1625
			
Shock Mount Part Number: SL-69	Nylon Bushing Part Number: PN 116	5/16-18 Nylon Insert Locknut Part Number: PN 510	10 x 1/4 Square Pan Self Drill Part Number: PN 872
			
Push Latch Part Number: TB 85623	Rotary Latch Part Number: TB 85624	Rod End Adaptor Part Number: TB 85626	
			

Replacement Parts for Toolbox Cont.

Shocks

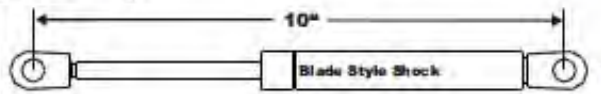

Blade Style Shock			
Shock #	20#	40#	70#
Part Number	SL1-20	SL1-40	SL1-70

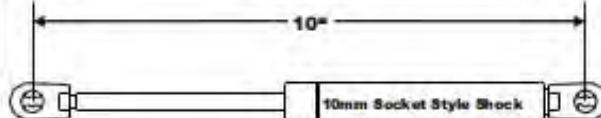

10mm Socket Style Shock			
Shock #	20#	40#	70#
Part Number	SL-3020	SL-3040	SL-3070

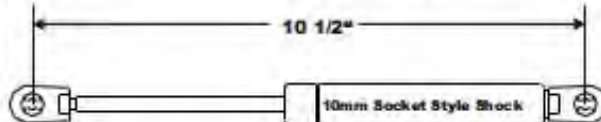

10mm Socket Style Shock					
Shock #	20#	40#	60#	80#	100#
Part Number	SL-3220	SL-3240D	SL-3260D	SL-3280D	SL-32100D

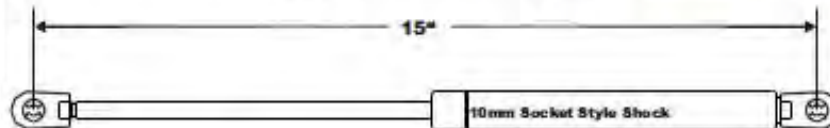

10MM Socket Style "Long" Style Shock		
Shock #	90#	40#
Part Number	SL-3390	SL-3340

Miscellaneous Parts

Foam Latch Gasket
Part Number: TB85409

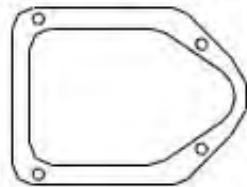

Shock Clip
Part Number: SL-81



Striker Assembly
Part Number: TB85616



Shock Mount Nut
Part Number: PN 301



Latch Cover Rivet
Part Number: PN 285



Latch Rivet
Part Number: PN 157



Hinge Rivet
Part Number: PN 762



Shock Mount
Part Number: SL-69

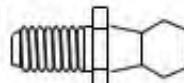

Rod Clip
Part Number: LCC-1

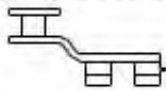

Rod Guide
Part Number: TB85615



1/4" Flat Washer
Part Number: PN 72B



1/4 x 1" Sheet Metal Screw
Part Number: PN 97B



1/4 x 1" Sheet Metal Screw
Part Number: PN 97



1/4 x 1" Button Head Screw
Part Number: PN 96B



1/4" Locknut
Part Number: PN 341B



Mounting Bracket
Part Number: TBBRACE1



Divider Mounting Channel
Part Number: TB-Channel



Toolbox Divider
Part Number: TB-Divider



Toolbox Divider Tape
Part Number: CO-Tape



Rear View: Locking Latch
Part Number: TB85613

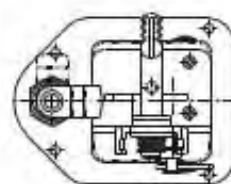

Rear View: Non-Locking Latch
Part Number: TB85614

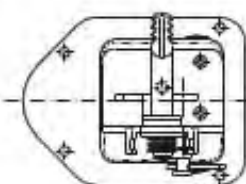

Rear View: Locking Hook
Part Number: Tb85608



Rear View: Non-Locking Hook
Part Number: Tb85608

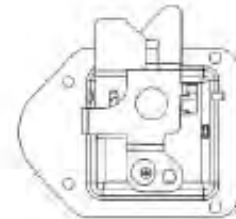

Ordering Replacement Parts:

Ordering replacement parts for your toolbox is fast, convenient, and easy. Just call our customer service phone number at 1-800-779-2102 for pricing and ordering information. Please provide the customer service representative with the part number from the above parts list.