





Installation Instructions All Weather Trail Cover

Vehicle Application

- Jeep Wrangler JK (2 Door)
2007 and newer
Part Number: 81040

www.Bestop.com - We're here to help! Visit our web site and click on ["Ask a Question"](#). Click here for more [Jeep Accessories by Bestop](#).

INSTALLATION TIME	SKILL LEVEL
 1/4 Hour	 1 - Easy

TOOLS
 Safety Glasses



 **CAUTION** Safety glasses should be worn at all times while installing this product.

Special Note:

This cover is to be installed on the vehicle without a complete top in place. The bows should be folded down if installation is on a soft top Wrangler.

This cover may be installed over a Duster and Bikini.

The straps are designed to fit the "stock" model, and may not latch to various steps and rocker guards added to the vehicle.

Installation Tips

Before you begin installing this assembly, read all instructions thoroughly.

Note:

It is normal for the fabric to contract and wrinkle when stored in the shipping carton. Within a few days after the installation, the fabric will relax and the wrinkles will disappear.

 **WARNING** This product is designed primarily to protect the interior of the vehicle from ordinary weather conditions. Please note that during prolonged exposure to heavy rain or snow, some seam leakage may occur. Please plan accordingly. This product will not protect the vehicle from falling objects. Never operate vehicle with this product installed. The Trail Cover is not made to cover the vehicle while vehicle is in tow.

Trail Cover – Installation Instructions

Parts List

Trail Cover Fabric	Qty - 1
Stuff Sack	Qty - 1

1 Preparing the Vehicle

- Make certain that the vehicle engine and all lights are turned off.
- Set the Emergency (Parking) Brake.
- Remove all personal possessions from the vehicle.

2 Place Trail Cover on Vehicle

Orient the Trail Cover with the Bestop label on the passenger's side. Drape the Trail Cover over the vehicle.

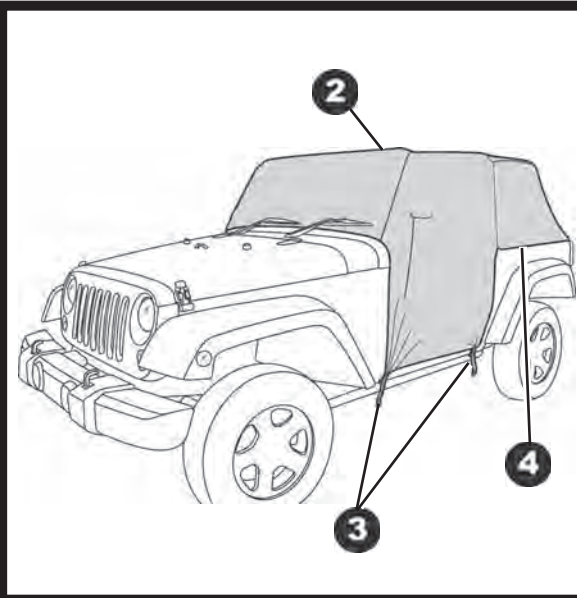
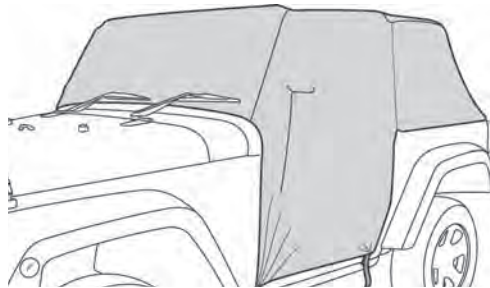

4 Secure Plastic Strips – Soft Top Vehicles Only

There are six (6) plastic strips sewn to each side of the Trail Cover. Slip them into the belt rail retainer on the side of the vehicle.

NOTE If you have a Duster installed on your vehicle, use only the adjustable straps to hold the Trail Cover in place.

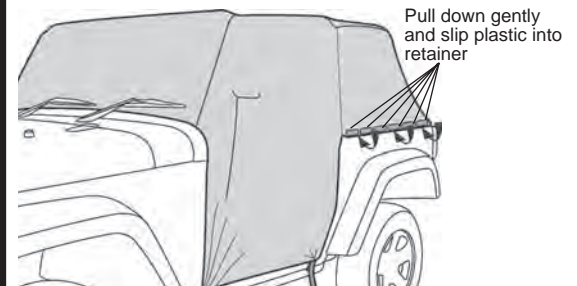

3 Secure Side Straps

Locate the two adjustable straps sewn on each side of the Trail Cover. Pull the straps down and hook them to the bottom of the vehicle.

Make sure that the fabric flap inside the cover lays flat behind the lower grommet.

Pull the end of each strap to tighten the straps so the cover fits snugly on the vehicle.

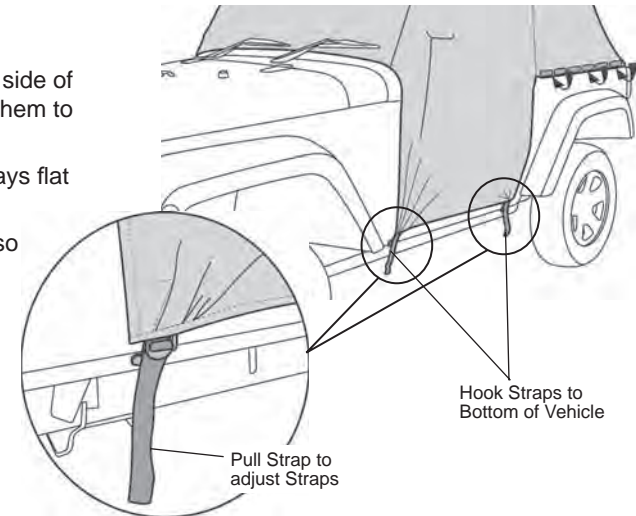

Trail Cover – Installation Instructions

5 Secure Rear of Cover

Locate the two adjustable straps sewn on the rear of the Trail Cover. Pull the straps down and hook them to the bottom of the tailgate. Adjust the tension as needed.

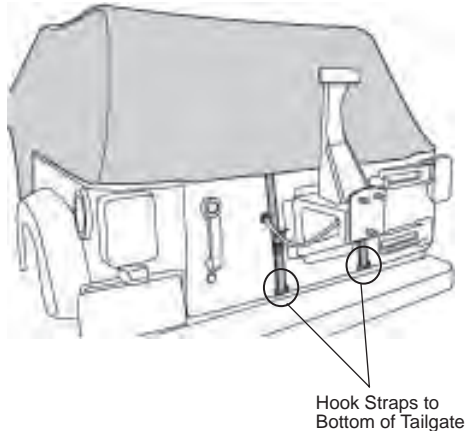

6 Install Cable Lock – Optional

The grommet on each side of the vehicle is to secure the cover to the vehicle. Thread a cable and lock through the grommet and through the mirror to secure the cover.

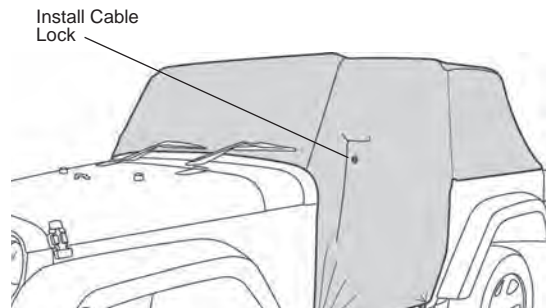

Care and Maintenance of your Bestop Cover

Your cover is made of the finest materials available. To keep it looking new and for the maximum possible wear, it will need periodic cleaning and maintenance.

Washing: The fabric should be washed often using soap, warm water and a soft bristle brush. Rinse with clear water to remove all traces of soap.

Water: Seeping through at the seams may be stopped by applying 3M Scotchgard® on the inside of the seams. Rips in the fabric may be repaired with Bondex® iron on patches to the Inside of the top, carefully following the Bondex® instructions.

Limited Warranty

We warrant our product to be free from defects in material and workmanship, for the terms specified below, provided there has been normal use and proper maintenance. This warranty applies to the original purchaser only. All remedies under this warranty are limited to the repair or replacement of any item or items found by the factory to be defective within the time period specified.

If you have a warranty claim, first you must call our factory at the number below for instructions. You must retain proof of purchase and submit a copy with any items returned for warranty work. Upon completion of warranty work, if any, we will return the repaired or replaced item or items to you freight prepaid. Damage to our products caused by accidents, fire, vandalism, negligence, misinstallation, misuse, Acts of God, or by defective parts not manufactured by us, is not covered under this warranty.

THE WARRANTY TIME PERIOD IS AS FOLLOWS: ALL "SOFT GOODS" MANUFACTURED BY OUR COMPANY (USING PRIMARILY VINYL, PLASTICS, AND/OR FOAM): ONE YEAR FROM DATE OF PURCHASE.

ANY IMPLIED WARRANTIES OF MERCHANTABILITY AND/OR FITNESS FOR A PARTICULAR PURPOSE CREATED HEREBY ARE LIMITED IN DURATION TO THE SAME DURATION AND SCOPE AS THE EXPRESS WRITTEN WARRANTY. OUR COMPANY SHALL NOT BE LIABLE FOR ANY INCIDENTAL OR CONSEQUENTIAL DAMAGE.

Some states do not allow limitations on how long an implied warranty lasts, or the exclusion or limitation of incidental or consequential damages, so the above limitations or exclusions may not apply to you.

This warranty gives you specific legal rights, and you may also have other rights which vary from state to state.



For further information or request for warranty work, please contact:

Bestop Inc. Customer Service

(800) 845-3567

(303) 465-1755