



# BLUE OX®

## Baseplate Installation Instructions

# BX3769 2007-11 Toyota Camry (Manual Only) Installation Instructions

Serial Number

Please read BOTH these Installation Instructions and the General Towing Instructions before attempting to install or operate this equipment.

- Blue Ox® towing products and accessories are intended to be installed by Blue Ox® Dealers who are familiar with our products and have the equipment and knowledge to do “fit work”. When necessary, Blue Ox® Dealers can be found at [www.blueox.com](http://www.blueox.com) or by contacting our Customer Care Department at (402) 385-3051.
- Many Blue Ox® Baseplates are designed to use existing holes and hardware to mount the baseplate to the towed vehicle. Even though bolts are there, do not assume they are adequate for baseplate mounting. Always use hardware supplied in the hardware kit or existing hardware specified in the Baseplate Installation Instructions.

Attachment Tab Height: 14 1/2”  
Attachment Tab Width: 20 3/4”

### Bolt Torque Specifications

Torque in Foot-Pounds for Metric Bolts

Bolt Size	Grade 8.8	Grade 10.9
6MM	6	8
8MM	16	22
10MM	31	40
12MM	54	70
14MM	89	117

Confirm the towability and pre-towing procedures for your vehicle with the owner’s manual or contact the vehicle’s manufacturer for specific towing procedures.

### Bolt Torque Specifications

Torque in Foot-Pounds for Inch Bolts

Bolt Size	Grade 5	Grade 8
1/4”	10	14
5/16”	19	29
3/8”	33	47
7/16”	54	78
1/2”	78	119
5/8”	154	230



If the front of your vehicle looks different than this, call us at (402) 385-3051.

## ⚠ WARNING

Failure to read and follow these instructions could result in separation of the towed vehicle from the tow bar, causing property damage, loss of towed vehicle, personal injury or death.

# BX3769

## 2007-11 Toyota Camry

### Installation Instructions

## Parts List

Ref. No.	Qty.	Part #	Description
1	1	61-6291	Weldment, Base Plate, BX3769
2	8	61-5208	3/8-16" Nut Plate, with 14" Wire
3	8	201-0440	3/8-16 x 1 1/2" Bolt, Grd. 5, ZP
4	8	203-0010	3/8" Lock Washer, ZP
5	2	201-0553	1/4-20 x 1/2" Hx. Wshd, Type F Screw
6	2	201-0192	#10-32 x 1/2" Slot, Rd. Hd. Screw
7	2	203-0054	#10 Lock Washer
8	2	202-0047	#10-32 Hex Nut
9	2	101-5822	Adapter, 4 Way Connector
10	2	62-3468	Attachment, Assembly, SF/SB (R)
	2	290-0437	Receiver Cap Plug, Black (Not Shown)
	2	226-0046	Baseplate Safety Cable, 36" CL III (Not Shown)
	2	229-0359	Quicklink, 3/8", ZP (Not Shown)

## Tools Required

- Loctite® RED
- 10mm Socket
- 14mm Socket
- 9/16" Socket
- Flat Cold Chisel
- Flat Screwdriver
- Phillips Screwdriver
- Tape Measure
- Utility Knife
- Hack Saw Blade
- Reciprocating Saw

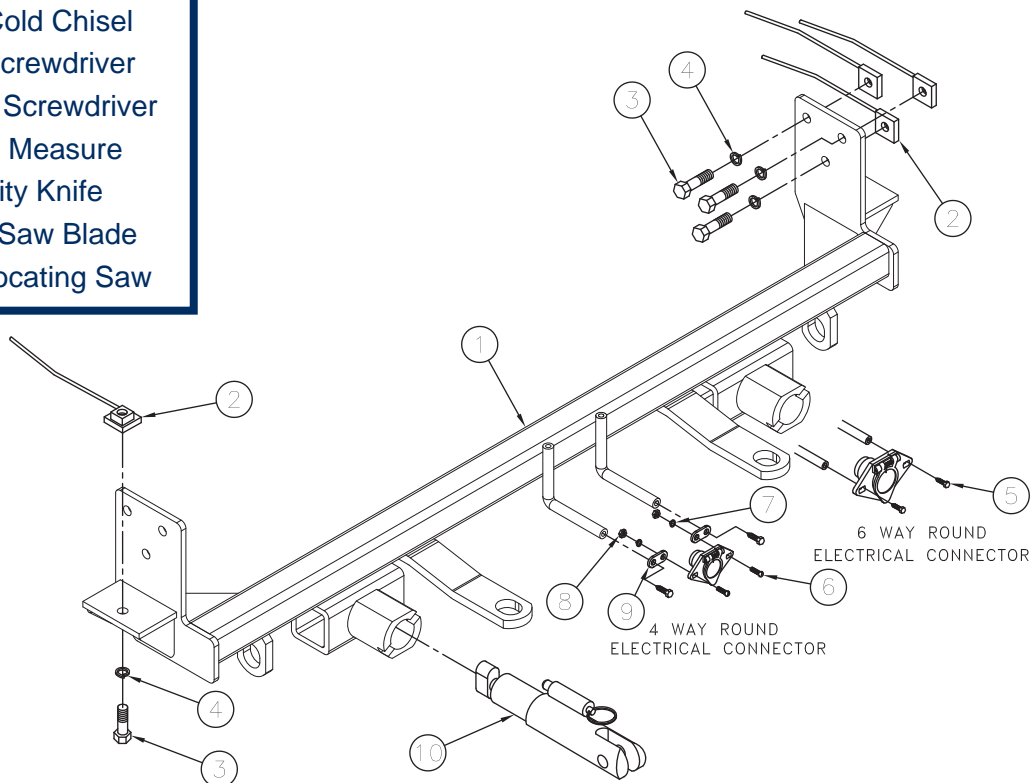

## Important:

Use only genuine factory replacement parts on your baseplate. Do **NOT** substitute homemade or non-typical parts. If a bolt is lost or in need of replacement, for your safety and the preservation of your baseplate, be sure to use a replacement bolt of the same grade (In most cases it will be Grade 5, please reference the parts list above). Replacement parts may be ordered through your nearest Blue Ox® Dealer or Distributor. Failing to follow and/or altering these installation instructions in either installation or required equipment will void the manufacturer's warranty.

BX3769

# 2007-11 Toyota Camry

## Installation Instructions

### Attachment Tabs:

Motorhome mount tow bars are recommended for use with this baseplate. Due to the design of the removable tabs, the RangeFinderII and Ambassador tow bars can not be used. Adapters, except the BX8833 and BX88151, can not be used with this baseplate.

**Installation Notes:** The fascia, horn cables, metal bumper and air dams are removed. The grille style is trimmed. Drilling is required.

The dimensional variations between otherwise identical vehicles can be considerable. While the baseplate was designed for easy installation, it may be necessary to tailor the baseplate slightly to compensate for auto manufacturer's tolerances. These minor adjustments may include filing a hole slightly, bending electrical rods or bending end plates.

The BX8848 4 Diode Wiring Kit is recommended for this vehicle.

Handling of some cosmetic parts when installing this product may require the use of protective covers, rags, specialty tools, etc. to prevent damage.

### Installation Instructions:



1. Remove two Phillips pushpins from top of fascia - the second and third in from the headlight. Do this to both sides of the vehicle. Set pushpins aside to be reinstalled later.



2. On the top center of the fascia, use the 10mm socket to remove one metric bolt. Set bolt aside to be reinstalled later.

BX3769  
2007-11 Toyota Camry  
Installation Instructions



3. On outside edge of wheel well, turn screw 90 degrees with the flat screwdriver to remove. Do this to both sides of the vehicle. Set screws aside to be reinstalled later.



4. Push wheel well cover aside to expose top edge of fascia. Remove one metric bolt using the 10mm socket. Do this to both sides of the vehicle. Set bolts aside to be reinstalled later.



5. Using the 10mm socket, remove three metric bolts from front edge of belly pan (see white arrows). Do this to both sides of the vehicle. On drivers side, remove one metric bolt from rear corner of belly pan (see grey arrow). Set bolts aside to be reinstalled later.

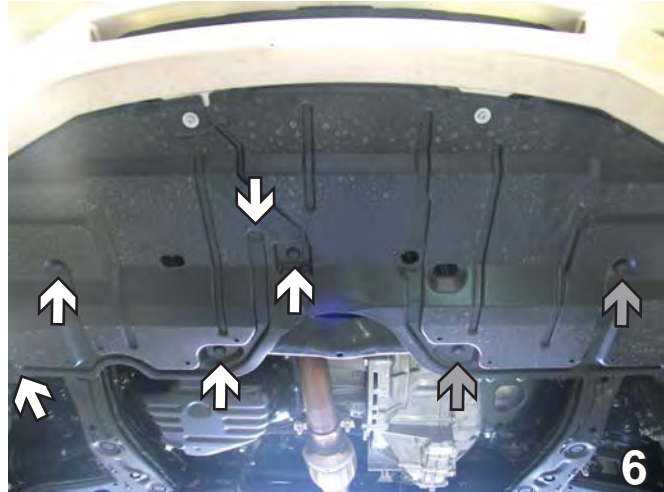

6. Remove five pushpins from passenger's side of belly pan (see white arrows). Remove two pushpins from driver's side of belly pan (see grey arrows). Set pushpins aside to be reinstalled later. Pull fascia forward to remove. Set pushpins, fascia and belly pan aside carefully to be reinstalled later.

BX3769  
2007-11 Toyota Camry  
Installation Instructions



7. On the side of the radiator, pull the air dam forward to remove. Do this to both sides of the vehicle. Set air dams aside to be reinstalled later.

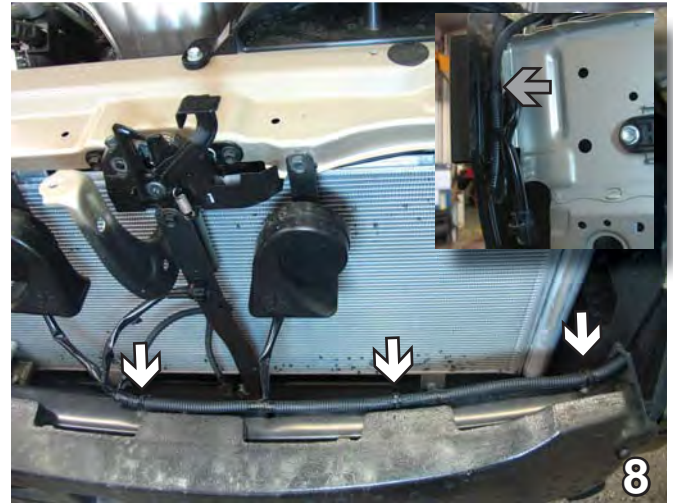

8. On the driver's side, disconnect the horn cable (with fog light connector, if so equipped) from a tie clip on the back of metal bumper (see grey arrow of inset). Disconnect the cable from three tie clips behind metal bumper (see white arrows). On the passenger's side, disconnect the horn cable from a tie clip on the back of metal bumper. Move the cables out of the way to prepare the area for baseplate installation.

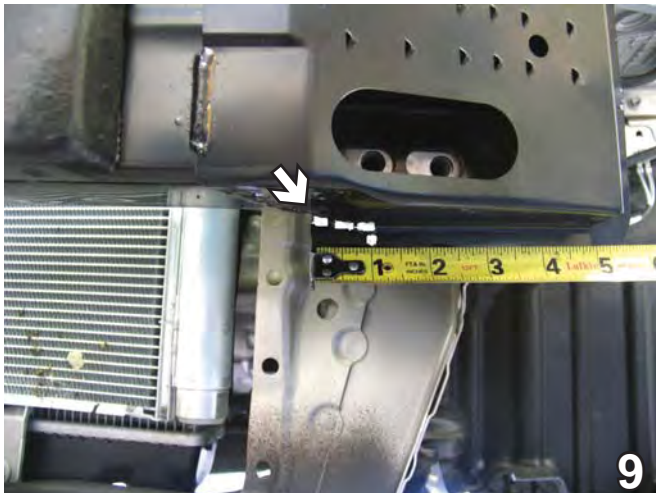

9. Using the reciprocating saw, start a cut at the top edge of the lower section of metal bumper. Cut horizontally one inch and then cut vertically all the way to the bottom of the bumper. Do this to both sides of the vehicle.

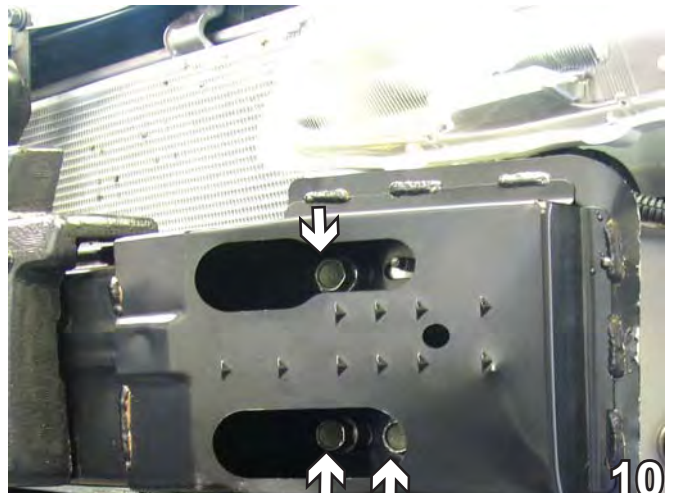

10. Using the 14mm socket, remove three metric bolts from the metal bumper. Do this to both sides of the vehicle. Pull the metal bumper forward to remove and set aside to be reinstalled later.

BX3769  
2007-11 Toyota Camry  
Installation Instructions



11. Using the flat cold chisel, remove the square nut on the inside of the frame rail. Do this to both sides of the vehicle.

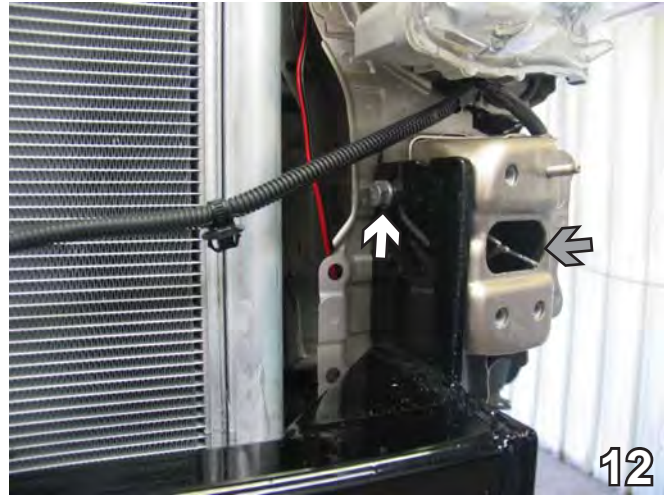

12. Slide baseplate against inside of frame rail, aligning top rear hole of baseplate to existing hole of frame rail (see white arrow). Insert 3/8-16 nut plate through frame rail opening (see grey arrow) and align to existing hole. Install 3/8-16 x 1 1/2" bolt with 3/8" lock washer and tighten. Clamp with the large vise grips.

**BE SURE TO USE LOCTITE® RED ON ALL BOLTS BEFORE TIGHTENING. TIGHTEN ALL BOLTS ACCORDING TO THE TORQUE CHART ON THE FRONT PAGE OF THESE INSTRUCTIONS OR ON PAGE 3 OF THE BASEPLATE TOWING GENERAL INSTRUCTIONS.**

**When using power drills be aware of the dangers of torque and drill bit length.**



13. Using the baseplate as a template, drill into the bottom of frame with the 13/32" drill bit. Insert nut plate and align to drilled hole. Install 3/8-16 x 1 1/2" bolt with 3/8" lock washer and tighten. Do this to both sides of the vehicle.

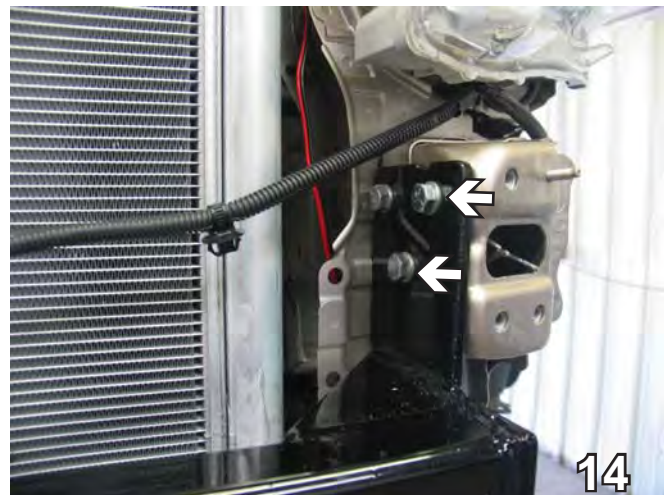

14. Using the baseplate as a template, drill the two remaining holes into the side of frame rail with the 13/32" drill bit. Insert nut plates and align to drilled holes. Install 3/8-16 x 1 1/2" bolts with 3/8" lock washers and tighten. Do this to both sides of the vehicle.

BX3769

# 2007-11 Toyota Camry

## Installation Instructions



15. Using the utility knife, cut the air dam (ribbed side up) horizontally and slightly below the midpoint of the air dam. Do this to both air dams. Reinstall the upper section of air dams.



16. Lay the fascia face up on a smooth, flat surface. Using the hack saw blade, remove the top rib in the upper corner of the grille style. Do this to both sides of the vehicle.



17. Attach the permanent baseplate safety cables to the provided convenience link on the baseplate (see grey arrow). The photo above shows the recommended installation of the cables to frame of vehicle (see white arrow). Additional options may interfere with suggested mounting; in this case secure the cables to a solid piece of the frame as described in the instructions included with the permanent baseplate safety cables. Be sure the safety cables do not rub against any hoses or moving parts. Do this to both sides of the vehicle.

**DEALER or INSTALLER:**  
Be certain the user receives the instruction sheets for their products.

Be sure that **ALL** electrical connections are plugged in properly and functioning **BEFORE** installing the fascia.

18. Reinstall the metal bumper, horn cables, fascia, pushpins and bolts.

Install the tow bar and safety cables according to the instructions provided in their packages. When demonstrating this to the customer, be sure to include all the contents and packages.

Do **NOT** substitute other devices if the tow bar pins and clips are misplaced.

BX3769  
2007-11 Toyota Camry  
Installation Instructions

## Customer Service Commitment

Blue Ox is committed to providing you with exceptional customer care throughout your lifetime with our products. Our team is here to assist you with any questions you may have regarding the performance of your product. Simply call 1-402-385-3051 and you can speak with our customer care team.

Additionally, please visit our website to see which rallies our Destination America team will be attending. For a nominal fee, our service technician will service your towing system to ensure it's in proper working condition. Also as a commitment to our customers, should you visit our factory you can stay at our full service Blue Ox campground at no charge along with enjoying a factory tour.

Again thank you for being our customer and for the confidence you have shown in the performance of our products. It is because of customers like you we enjoy the success we have today.



Shown without removable tabs installed.



Shown with removable tabs installed.



© 2006, 07, 08, 09, 11 Blue Ox  
One Mill Road, Industrial Park  
Pender, Nebraska 68047  
Phone: (402) 385-3051 • Fax: (402) 385-3360  
[www.blueox.com](http://www.blueox.com)