

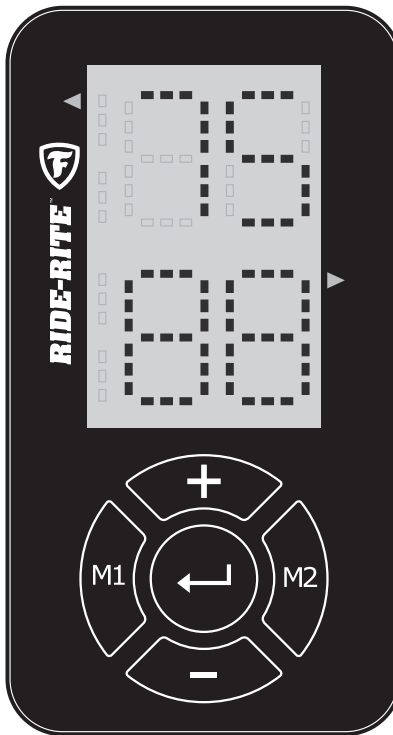

riderite.com

INSTALLATION INSTRUCTIONS



Firestone

*World's Number 1
Air Spring.*



FIRESTONE INDUSTRIAL PRODUCTS COMPANY

IMPORTANT

PLEASE DON'T HURT YOURSELF, THE KIT, OR YOUR VEHICLE. TAKE A MINUTE TO READ THIS IMPORTANT INFORMATION.

SAFE INSTALLATION

Please take all safety precautions during installation. A hydraulic jack can fail, and if that happens, you can be seriously hurt, or worse, if you are relying on it to hold up the vehicle. If you use a hydraulic jack, secure jack stands in the appropriate locations and chock any tires still touching the ground.

Wear safety glasses or goggles. Your eyes may be lower than some parts and pieces, and you don't want to lose an eye.

Remove the possibility of any electrical issues by disconnecting the negative battery cable.

VEHICLE GVWR

NEVER exceed the maximum load recommended by the vehicle manufacturer (GVWR). The GVWR can be found in your vehicle's owner's manual or on the data plate on the driver's side door. Consult your local dealership for additional GVWR specifications.

PRESSURE TO LOAD

Be sure to review the load limits noted in the Air Spring Kit Installation Instructions (sold separately).

APPROPRIATE AIR PRESSURE

For best ride, use only enough air pressure in the Air Springs to level the vehicle when viewed from the side (front to rear). This will vary, depending on the load, location of the load, condition of the existing suspension, and personal preference.

**ONCE INSTALLED SUCCESSFULLY, FOLLOW THE PRESSURE REQUIREMENTS FOR THE AIR SPRINGS.
FOR FIRESTONE, GENERALLY:**

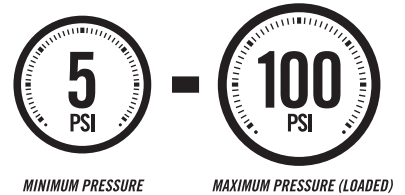
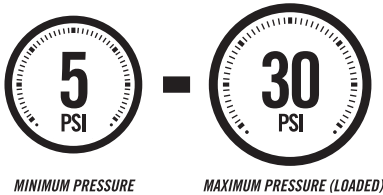



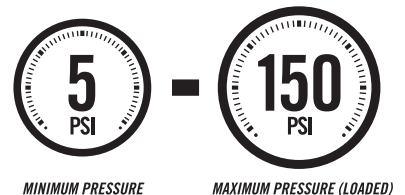



RED LABEL AIR SPRING REQUIREMENTS:



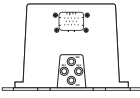
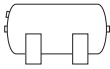



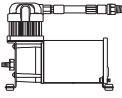
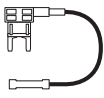











PARTS

Compare the parts below to your kit. Ensure you have all pieces, and organize them for an easier installation.

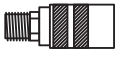
MAIN KIT CONTENTS

PART # 9490		x1 WIRELESS CONTROLLER	PART # 9489		x1 ECU	PART # 9420		x1 2 GALLON AIR TANK
PART # 9491		x1 WIRE HARNESS	PART # 9194		x1 INFLATION HOSE	PART # 9195		x1 INFLATOR AND GAUGE KIT
PART # 9415		x1 AIR LINE TUBE (22 FEET)	PART # 9287		x1 AIR COMPRESSOR			
PART # 7543		x1 IGNITION FUSE TAP (Use Part # 2526 for replacement)	PART # 9301		x1 STORAGE BAG			

A21-760-2592 HARDWARE PACK

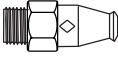
PT # 0070		x4 3/8" - 16 x 1" HEX HEAD BOLT	PT # 3067		x4 3/8" - 16 FLANGE LOCK NUT	PT # 9275		x4 VELCRO TAB
PT # 0071		x8 3/8" FLAT WASHER	PT # 3088		x11 10-32 NYLOCK NUT	PT # 9036		x20 RED NYLON TIE
PT # 3083		x1 1/4" NPT FEMALE FITTING	PT # 9361		x1 SEALED RELAY	PT # 0899		x4 THERMAL SLEEVE
PT # 3086		x14 3/16" FLAT WASHER	PT # 9196		x1 DRY COUPLER FITTING			
PT # 3421		x3 10-16 x 3/4" SELF-TAPPING SCREW	PT # 3146		x1 BULKHEAD ASSEMBLY			
PT # 3087		x4 10-32 x 1" MACHINE SCREW	PT # 3046		x3 1/4" NPT PUSH-TO-CONNECT STRAIGHT FITTING			
PT # 3093		x4 10-32 x 3/4" MACHINE SCREW	PT # 3055		x1 1/8" NPT PUSH-TO-CONNECT STRAIGHT FITTING			

CONTENTS AND OVERVIEW

PAGE **4** PLANNING THE INSTALL

PAGE **5** PREPARE THE AIR COMPRESSOR AND TANK

PAGE **6** DRILL HOLES FOR AIR COMPRESSOR, ECU AND TANK

PAGE **7** INSTALL MAIN COMPONENTS

PAGE **8** INSTALL THE WIRING

PAGE **9** INSTALL THE AIR LINE TUBES AND FITTINGS

PAGE **10** INSTALL THE BULKHEAD ASSEMBLY AND USING THE INFLATOR

PAGE **11** USING THE WIRELESS CONTROLLER

PAGE **12** FREQUENTLY ASKED QUESTIONS

PAGE **13** TEST THE SYSTEM

PAGE **14** FIX AN AIR LEAK

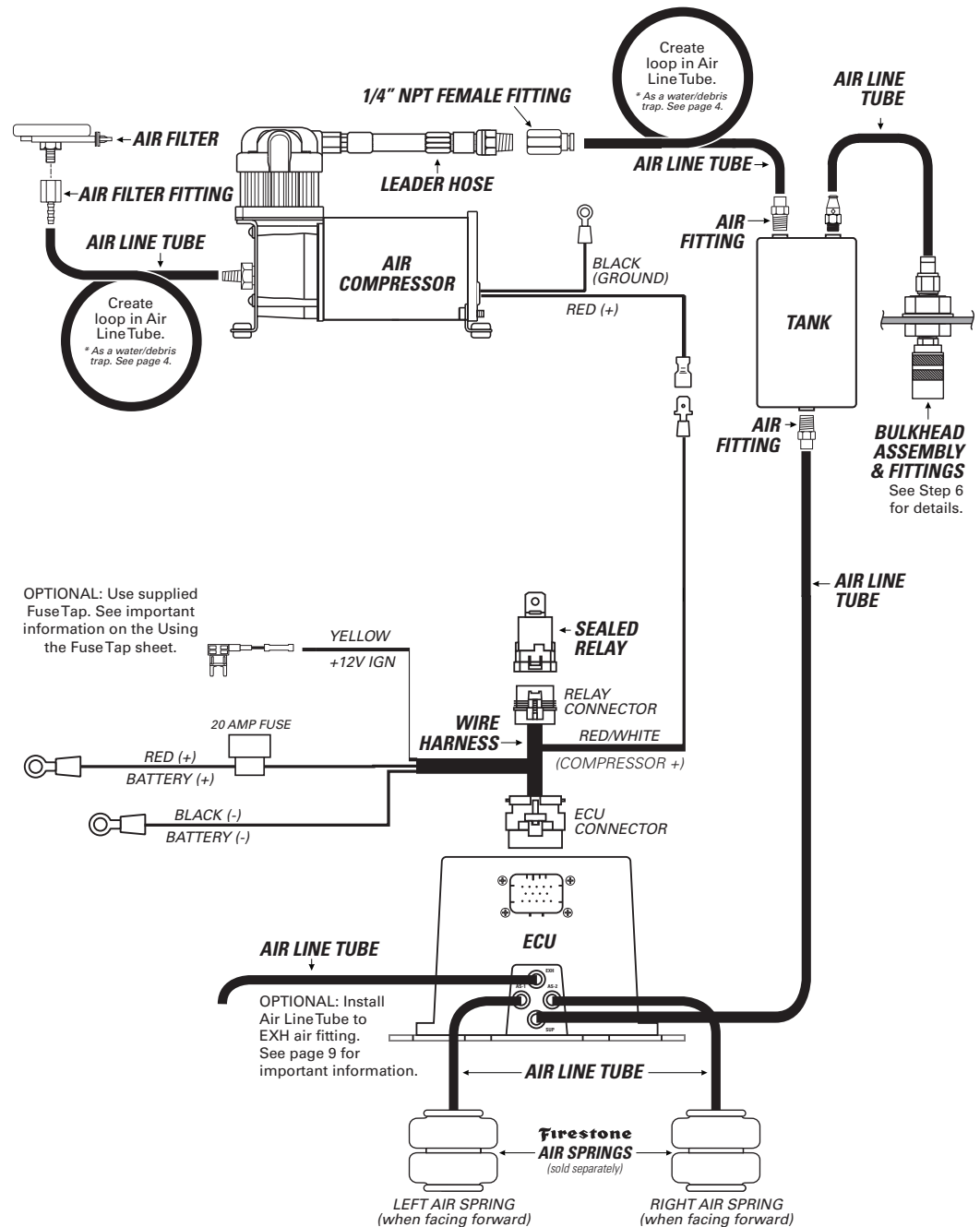

PLANNING THE INSTALL

THESE PLANNING STEPS WILL HELP YOU SAVE TIME AND WILL MAKE THE INSTALLATION EASIER.

DETERMINE THE MOUNTING LOCATION FOR THE AIR COMPRESSOR

- Provides ample air flow and is protected from airborne debris and moisture.
- Mount close enough to the ECU to allow Wire Harness connections to reach.
- If using the optional Firestone Air Accessory Mounting Kit, consider the guidelines above, and follow the kit's instructions.

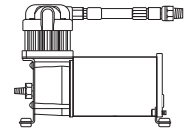

DETERMINE THE MOUNTING LOCATION FOR THE ECU

- Mount close enough to the Air Compressor to allow Wire Harness connections to reach.
- Allow room for Air Line Tubes to connect to the air fittings on the ECU.
- Allow room for the 14-pin ECU connector to connect to the ECU.
- Allow room for the Air Line Tube to run without sharp curves or bends.
- Using supplied fasteners shown in Step 3 is recommended. If no other mounting option is available, see the sidebar on Step 2 for using the Large Nylon Ties.
- Select a location that is solid and secure on the body or frame of the vehicle, away from any moving parts, electrical or any other lines.

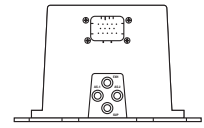

DETERMINE THE MOUNTING LOCATION FOR THE TANK

- Mount close to the ECU, in an area protected from airborne debris and moisture.
- Allow room for Air Line Tubes to connect to the air fittings on the tank. See diagram to left.

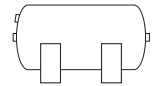

PLAN INSTALLATION ROUTES FOR WIRING AND AIR LINES

- Make sure the Wire Harness and Air Line Tubes are not exposed to sharp metal edges that can damage them.
- Use supplied Thermal Sleeves on Air Line Tubes when routing near heat sources.
- Use supplied Nylon Ties to secure Air Line Tubes and Wire Harness to the vehicle.
- Make a loop in the Air Line Tube where shown. This creates a water/debris trap that protects the Air Compressor.
- Measure twice, cut once!

TAPE ALL ELECTRICAL CONNECTIONS

- Use electrical tape to appropriately secure and protect all electrical connections.

USING PUSH-TO-CONNECT FITTINGS FOR AIR LINES

Your kit includes Push-to-Connect fittings to connect the Air Line Tubes to hardware. Use the instructions below when using the Air Line Tubes.

- 1** Insert end of Air Line Tube into air fitting.

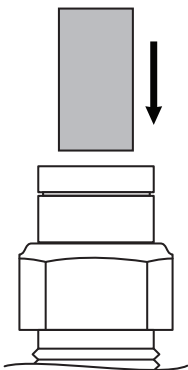

- 2** Push Air Line Tube into air fitting as far as possible.

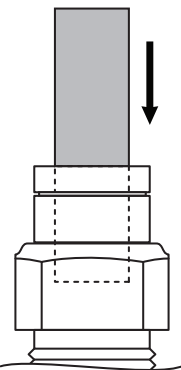

- 3** Gently pull on the Air Line Tube to check for a secure fit.

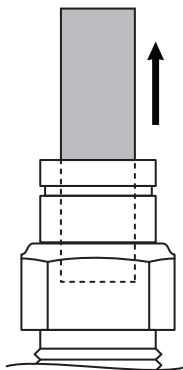

- 4** To remove, push down collar and gently pull Air Line Tube away.

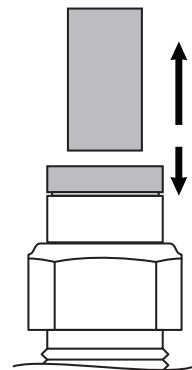

Removal Tip: Use a 1/4", 5/16", or 6mm open-ended wrench to push the collar down.

1

PREPARE THE AIR COMPRESSOR AND TANK

NOTE: Air Compressor can be mounted facing any direction.

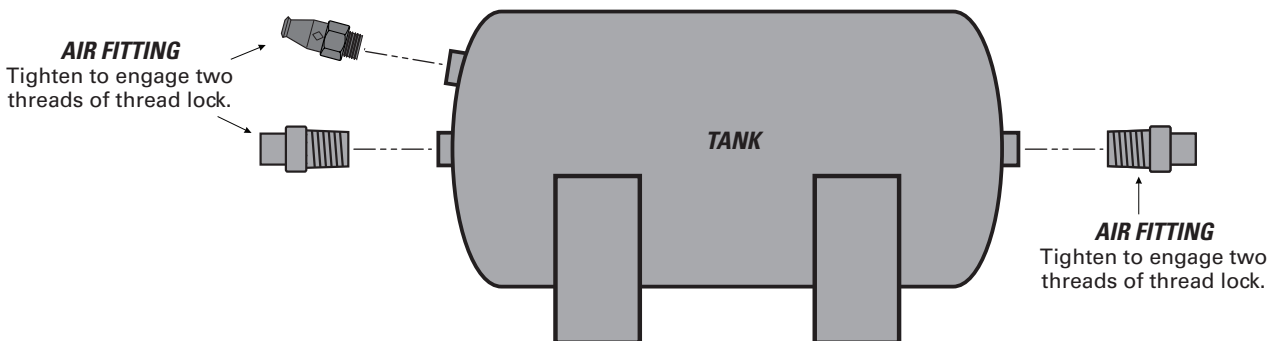
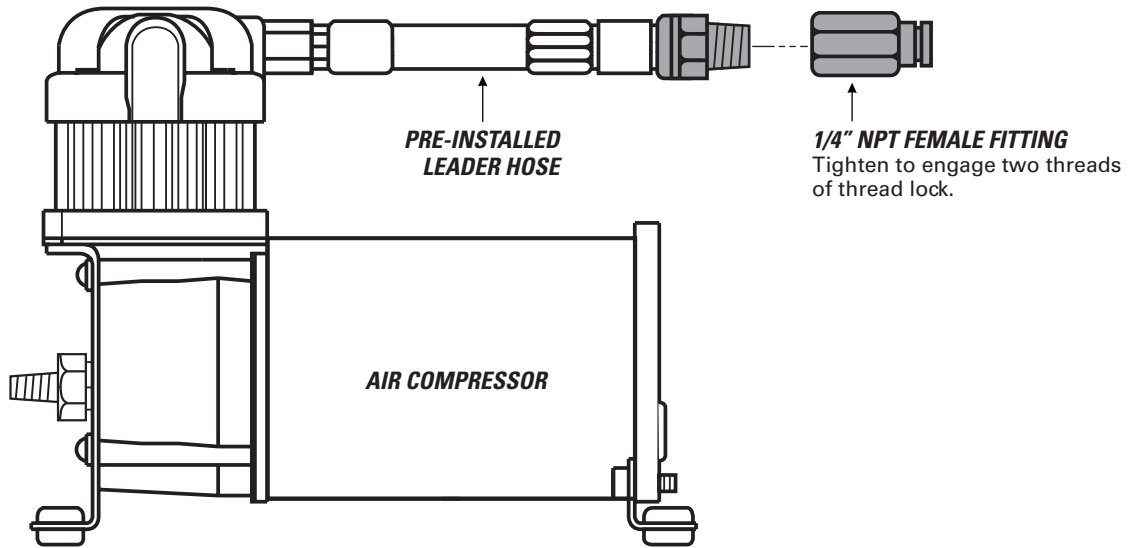
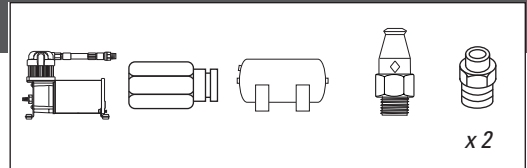

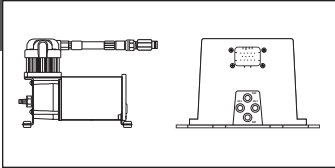

CHECK SURROUNDING AREA AND BACK SIDE OF MOUNTING LOCATION TO AVOID DRILLING INTO EXISTING LINES OR WIRING.

Drill within reach of the ground wire ring terminal on body or frame of vehicle. **AIR ACCESSORY MOUNTING KIT CANNOT BE USED AS A GROUNDING LOCATION FOR THE AIR COMPRESSOR.**



IF YOU ARE USING THE OPTIONAL FIRESTONE AIR ACCESSORY OR TANK MOUNTING KITS, SKIP THIS STEP AND REFER TO THE MOUNTING KIT'S INSTRUCTIONS.

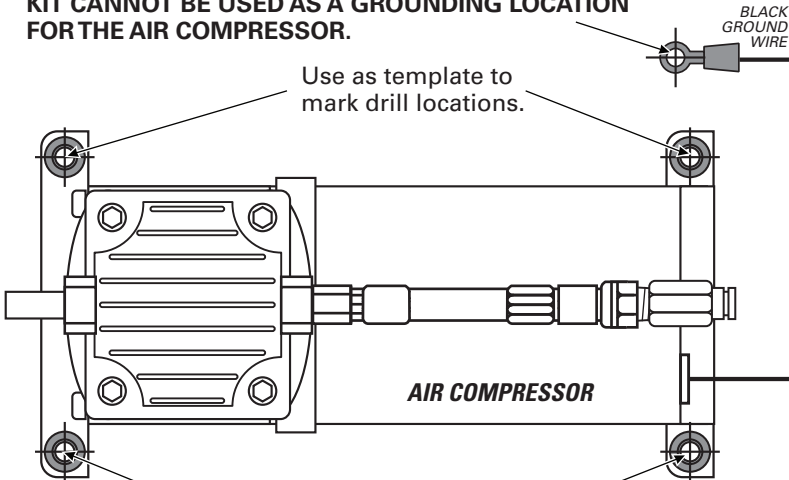

1 Using the Air Compressor and ECU as templates, mark drill locations as shown with a punch or marking tool. Follow guidelines below for tank mounting holes.

2 Mark Air Compressor ground wire fastening location within reach of the ground wire ring terminal.

3 Drill 3/16" diameter holes for the ECU and Air Compressor and 7/16" holes for the Tank. Remove any burrs and debris from drill holes.

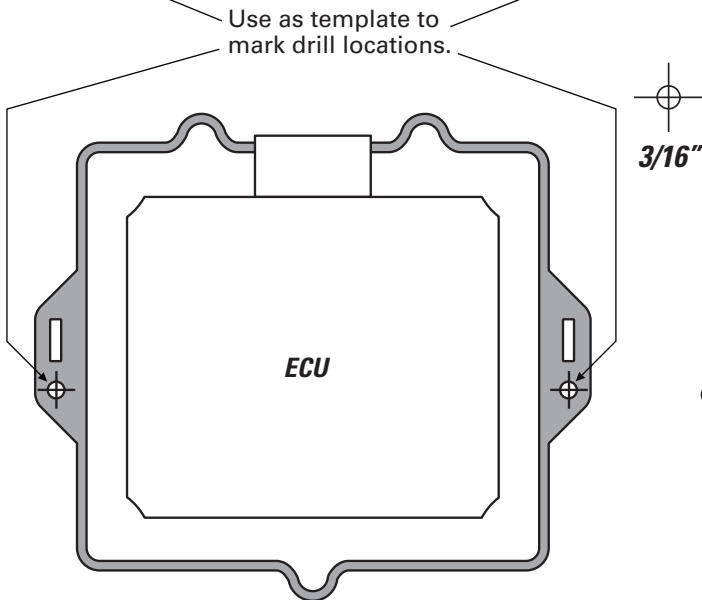

ASSURE THAT YOU INSTALL THE AIR COMPRESSOR AND ECU CLOSE ENOUGH SO THE CONNECTORS ON THE WIRE HARNESS WILL REACH THEM BOTH.

For tank mounts, make marks as shown below. The tank feet will mount at these locations.

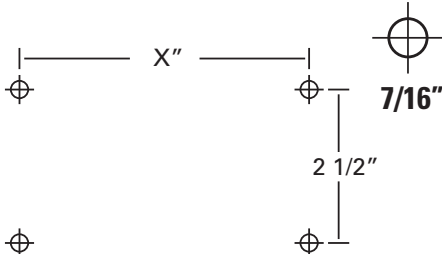

OPTIONAL ECU MOUNTING

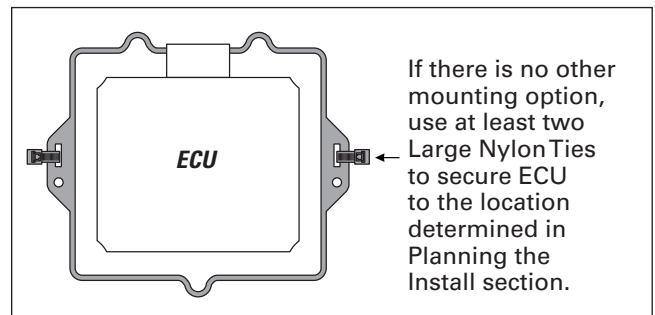

3

INSTALL MAIN COMPONENTS

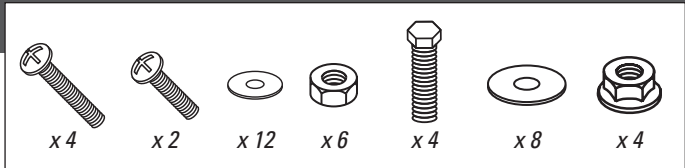

DO NOT OVER TIGHTEN MOUNTING BOLTS AND NUTS ON THE AIR COMPRESSOR. TOO MUCH TORQUE CAN CRUSH THE BRASS INSERTS AND RUBBER ISOLATORS.

1 Mount the Air Compressor to the drill hole location using the supplied fasteners. DO NOT OVER TIGHTEN.

2 Mount the ECU and Tank to the drill hole locations from Step 2 using the supplied fasteners.

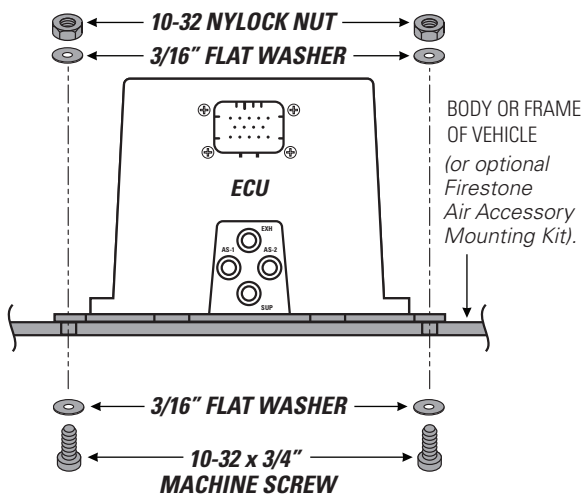
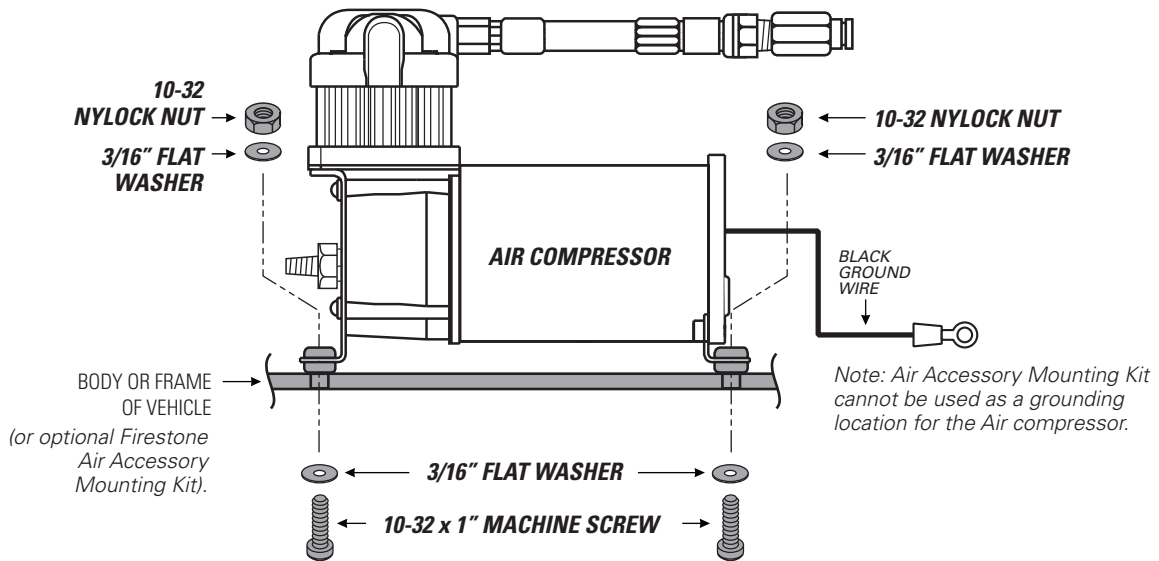

Note: Self-tapping screws can be used instead of machine screws.

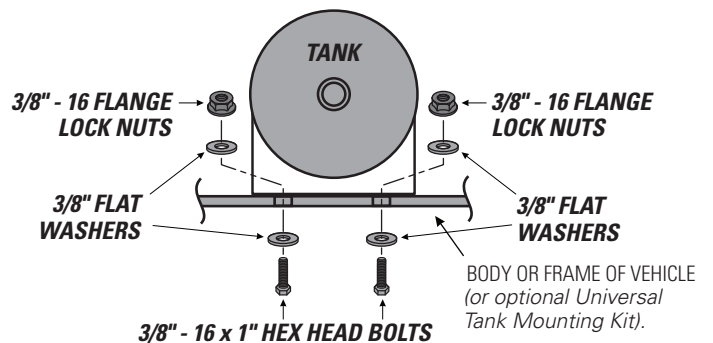

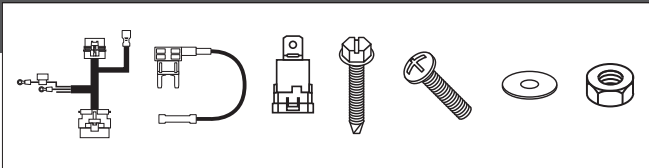

1 Determine a suitable location to mount the Sealed Relay, assuring it will be within reach of the relay connector on the Wire Harness.

2 Securely fasten the Sealed Relay. See fastener note.

3 Route the Wire Harness in the most protected manner possible, and securely make all connections as shown. Ground wires can share a common mounting location.

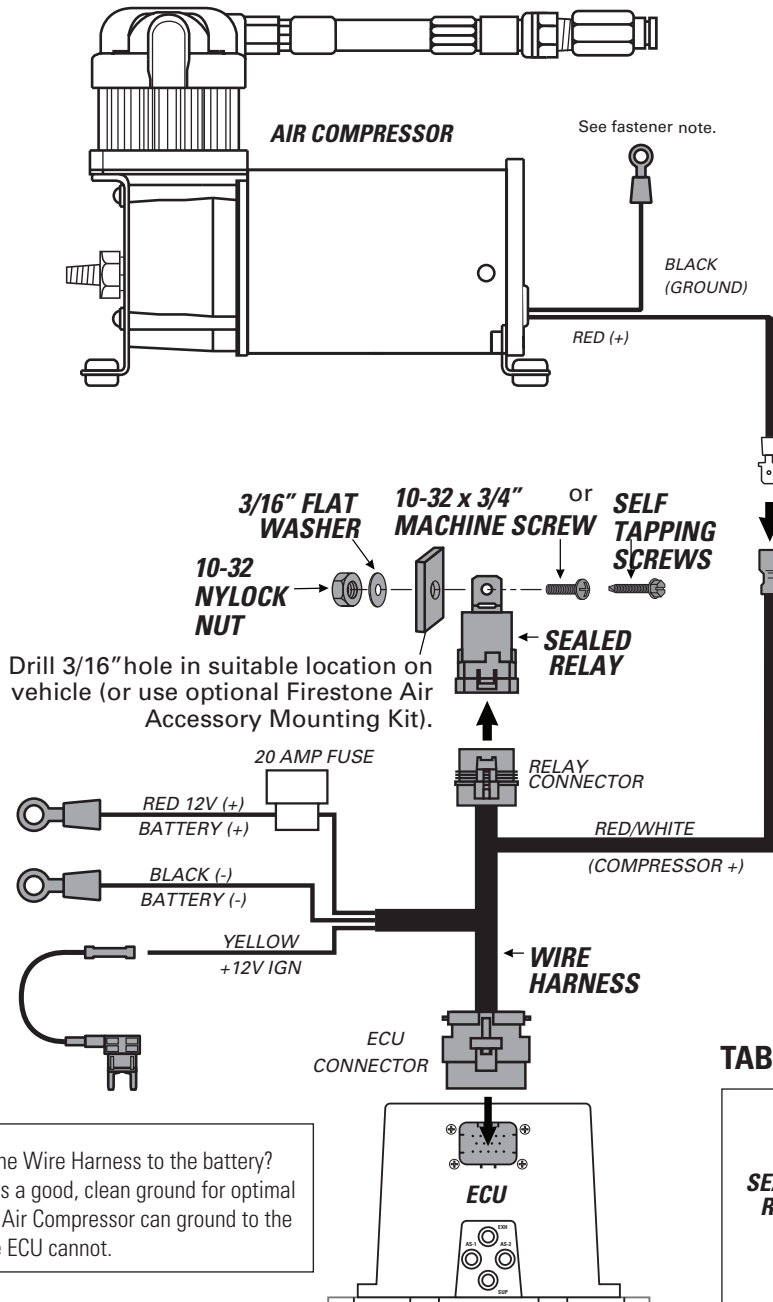

GROUND AND RELAY FASTENER OPTIONS

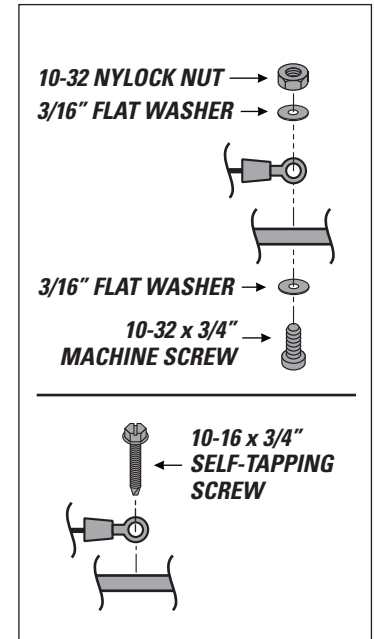

Why ground the Wire Harness to the battery? The ECU needs a good, clean ground for optimal accuracy. The Air Compressor can ground to the frame, but the ECU cannot.

TAB CONNECTOR EXAMPLE

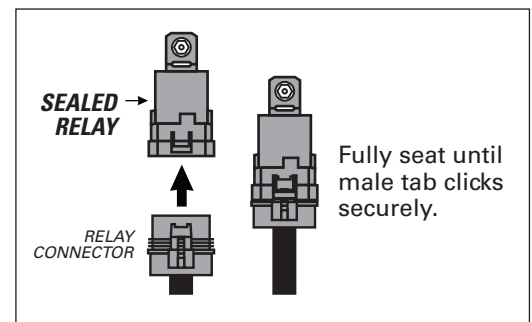

5

INSTALL AIR LINE TUBES AND FITTINGS

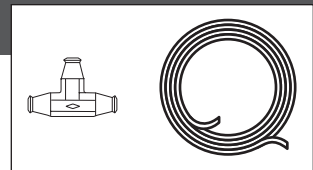

EXHAUST ALL AIR FROM THE SYSTEM PRIOR TO RELEASING AIR TUBES FROM AIR FITTINGS.



1 Route the Air Line Tube from the 1/4" NPT Female Fitting to the Tank, leaving room to secure it safely. Use the guidelines on page 4 for proper Push-to-Connect Fitting install.

2 Repeat Step 1 to route Air Line Tube from the ECU to the Air Springs. Use the AS-1 and AS-2 air fittings on the ECU.

3 Route Air Line Tube to the remaining fittings as shown. See Step 7 to plan location of Bulkhead Assembly.

4 Use supplied Nylon Ties to install the Air Filter in a dry, secure place, away from dirt and debris. Periodically check the Air Filter during operation, and replace it when it becomes dirty.

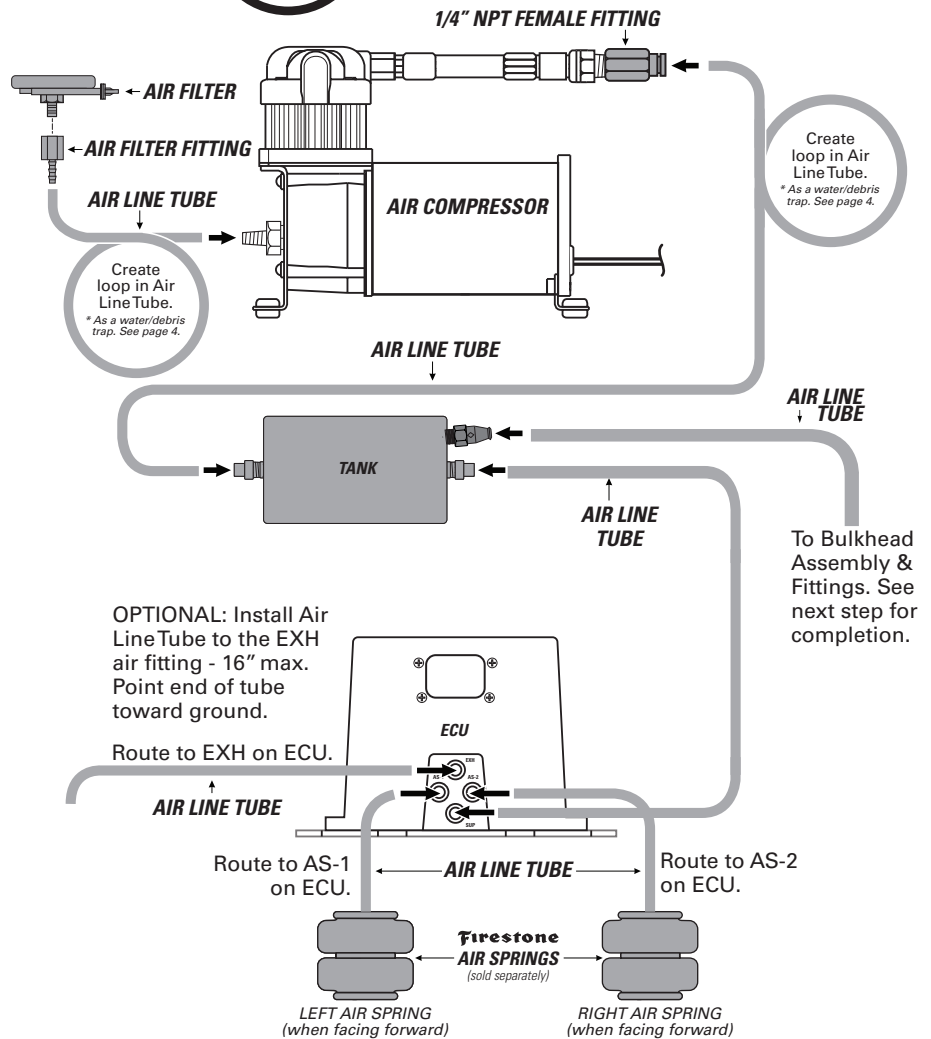

DO

Make sure the cut is as square as possible. Use a tube cutter or very sharp utility knife.

DON'T

Fold or kink the Air Line Tube. Cut the Air Line Tube at an angle. Use pliers, scissors, snips, saws, or side cutters.

PROPER AND IMPROPER CUTS IN THE AIR LINE TUBE

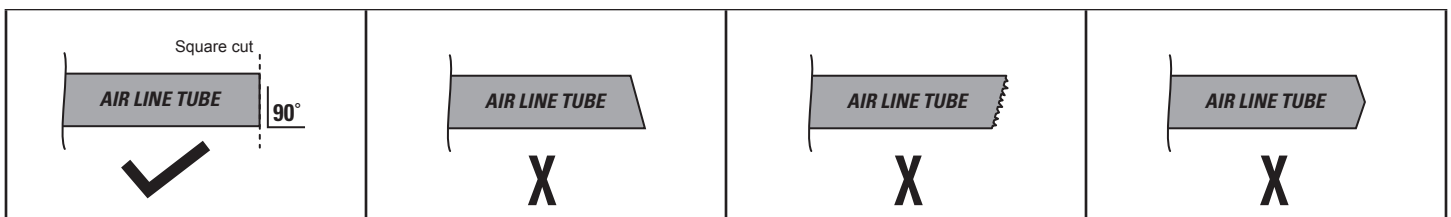

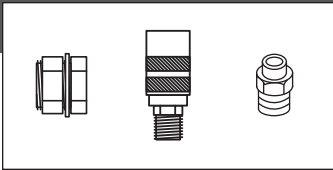

1 Determine a suitable location to mount the Bulkhead Assembly and Fittings. This area should be convenient to access and safe from debris. Make sure you have room to attach the Inflation Hose.

2 Drill a 3/4" hole in the selected mounting location and install the Bulkhead Assembly components, Air Fitting and Dry Coupler Fitting, as shown.

3 Install Air Line Tube from the Push-to-Connect on the Air Tank to the Air Fitting installed into the Bulkhead Assembly.

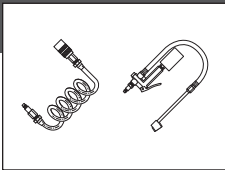
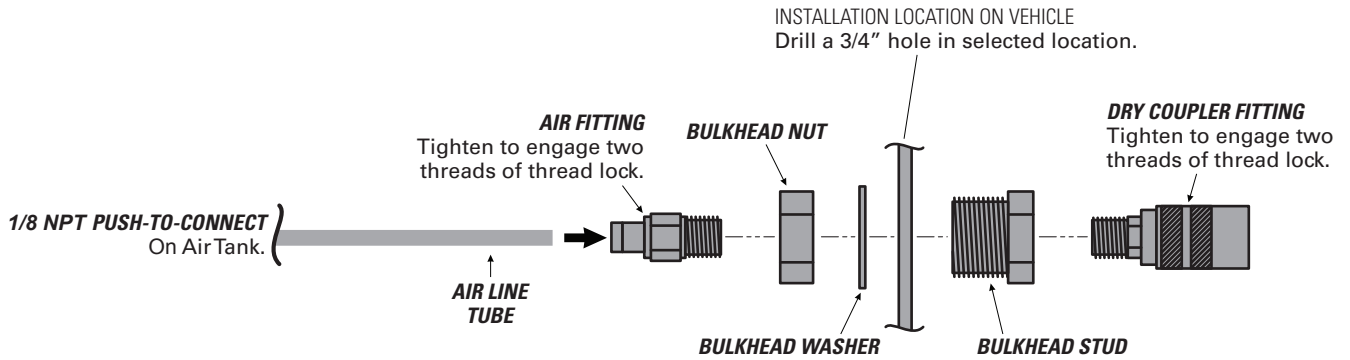

Connect the male air fittings to the dry couplers to use the Inflation Hose and Inflator. When finished, simply disconnect and store in the supplied Firestone Storage Bag.

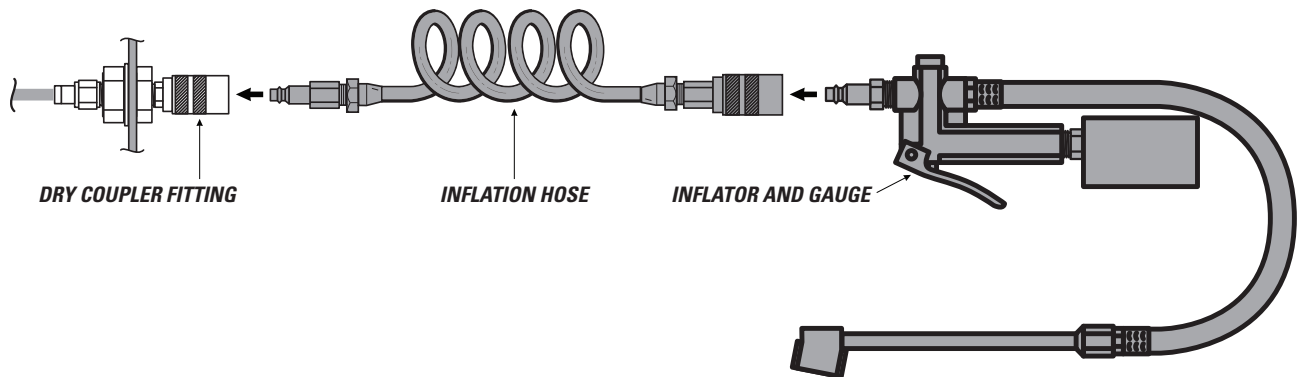

8

USING THE WIRELESS CONTROLLER

Use the Wireless Controller to adjust the air pressure in your Air Springs. You can select the Air Springs individually, or both at the same time. Determine sides when in vehicle, facing forward. If desired, use the supplied Velcro Tabs to secure the remote to the vehicle.



F3 REMOTE FUNCTIONS

On/Off

Hold **Enter** button for 3 seconds to turn the remote ON/OFF.

Inflating/Deflating Pressure for Both Air Springs

Turn on the remote to enter the main menu. Press **Enter** to adjust both air springs. Adjust pressure by pressing (+) or (-) button to desired pressure setting. Press the **Enter** button when desired setting is reached.

Inflating/Deflating Pressure for Individual Air Springs

Turn on the remote to enter main menu. Press **Enter** to adjust both air springs. Press **Enter** again to adjust individual air springs. Adjust pressure by pressing (+) or (-) button to the desired pressure setting. Press the **Enter** button when the desired setting is reached.

2 Memory Button Settings

Press **M1** or **M2** button. Preset pressure should appear. M1 is preset to 5 PSI. M2 is preset to 20PSI. Press the **Enter** button again to adjust pressure. To change the preset pressure, press **M1** or **M2**. Change the preset pressure by pressing (+) or (-) button. To save the pressure setting to memory, press and hold **Enter** button for 3 seconds. The display will flash rapidly to indicate the new pressure setting is saved. After saving the new pressure, the menu will revert to main menu.

Changing Units to PSI/BAR

Press (+) and (-) buttons together for 3 seconds. Once in the unit measurement menu, press (+) for PSI and (-) for BAR. Press **Enter** again to save the desired unit measurement and revert back to main menu.

Tank Mode

To convert to Tank Mode, unplug power to the ECU, install the tank and repower the ECU. The system will automatically enter Tank Mode.

Tank Mode Menu

Press and hold **M1** and **M2** buttons for 3 seconds to enter Tank Mode. While in Tank Mode, **T** will appear on the top row and the current tank pressure on the bottom row. Preset tank pressure range is 110-145/90-120. M1 is preset to 110/145. M2 is preset to 90/120. *Note: In Tank Mode, it is not advised to set air springs above Tank Pressure lower limit. User should first raise the lower limit threshold to a higher range before increasing pressure in Air Spring.*

F3 REMOTE ERROR CODES

Error Definition

Communication Error: An error message **E/CN** will display if communication from the ECU to the remote is not established for 2 seconds.

Leak Error: The remote will display **EL** in the top row if a leak is present and either **t**-tank, **L**-left air spring or **r**-right air spring on the bottom row to notify which component is leaking.

Bad Pressure Sensor: The remote will display **EP** in the top row if a bad pressure sensor is present and either **t**-tank, **L**-left air spring, **r**-right air spring in the bottom to notify which component has the bad pressure sensor.

Compressor Error: The remote will display **EC** on the top row if the compressor exceeds 4 minutes of runtime.

Low Battery: The remote will display **Lo Bt** on the display if batteries are below the rated voltage of 3.0 V. *Note: when the low battery indicator is present, the remote will be unable to save the last setting by the user.*

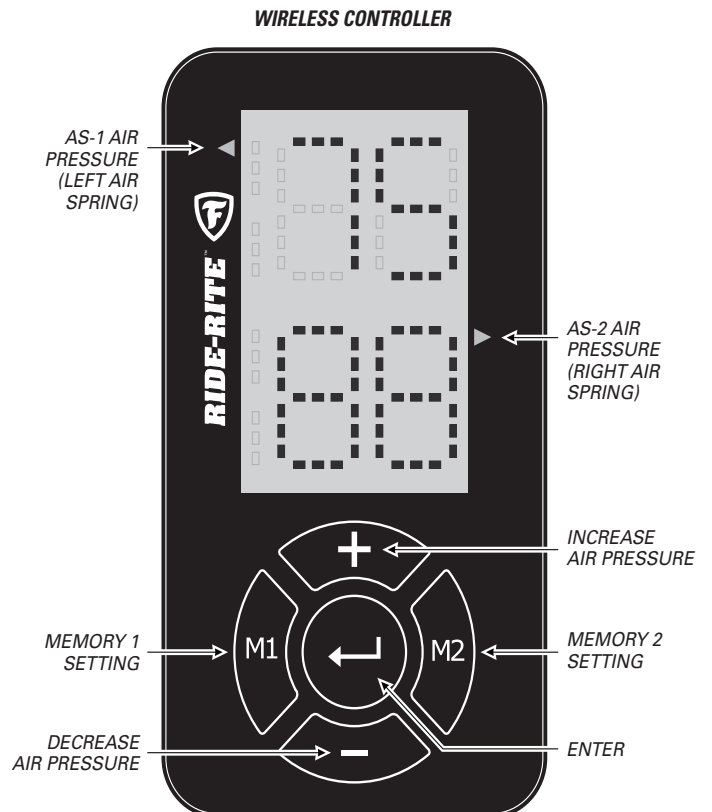

1) Why is my system not powering up?

When the system does not power up, usually this is a strong indication of improper power and grounding. Ensure that the power line (red wire) is attached to a +12 volt power source (battery). The grounding line (black wire), should be rerouted back to the battery, not the frame of the car. Traditionally, techs have used the frame the car as a grounding source, but through experience, we have seen that using the true ground (battery) offers the best connection for the device. Next, ensure that the yellow line is connected to the ignition fuse located in your vehicles fuse box. Please make sure the fuse on the F3 wiring harness is installed and not blown. It is important to confirm with a meter (if possible) that the fuse is on only when the ignition is engaged and off when the ignition is off.

2) Why are my buttons not responding correctly?

When your remote controller appears to not operate as intended, some of the key items you need to check are: battery charge (+3v), proper connection to the ECU, EC/N Code (refer to #7), barriers that are in between the ECU and the remote, proper powering (refer to #1).

3) Why is my compressor not shutting off?

When your compressor stays on even after the ignition switch has been placed to the off position, please ensure that the yellow line is tied to a switched fuse in the fuse box. To ensure this, please use a volt meter to confirm that the line is on (+12v), if and only if the ignition switch is in the ON position, and OFF when in the off position.

4) My remote does not work inside my cabin. What should I do?

With the improvements in technology, some cars are equipped with other electronic equipment which may cause interference to the F3 system. Others vehicles are equipped with noise canceling material and equipment which also play a role in the interference of the F3 connectivity. To check if either of these scenarios is true, confirm that your unit works properly if operated outside. If your unit does operate as intended outside the vehicle, contact us for further solutions.

5) Why does my system not turn on when I turn the ignition on?

When your F3 system does not turn on when the ignition switch is on the on position, this is a strong indicator that the unit is not powered/grounded correctly. Please refer to question #1.

6) Why does my remote freeze when I am trying to change pressure?

When your remote is freezing, this is an indication that the communication is out of range/ batteries have insufficient charge or you may have a bad remote. If the batteries are low, replace the batteries. If the communication range is over 30 meters, operate the unit in close proximity. If the issue still persists, contact our tech line to receive a replacement. In order to receive a placement, please have your receipt to show proof of purchase.

7) Why does my remote display "E/CN" when attempting to change pressure?

The "E/CN" code is an indicator that the remote is not communicating to the ECU. When this occurs, this is an indicator that the ECU is not powered or the user is out of range. When the ECU is not powered, please refer to question #1. If the user is out of range, ensure to get within the range of 30meters (98 feet).

8) What should I do when the remote goes to sleep before it meets the set pressure?

Check battery voltage.

9) Is it normal for my compressor to be overworking when attempting to reach pressure?

When the compressor sounds as if it is overworking to get to pressure, relax. This is normal. The ECU was programmed to reach the designated pressure as accurately as possible. To reduce the over usage of the compressor, use the system only when needed. Having two preset settings will reduce the over usage and increase the system lifetime.

10) Why does my compressor run while exhausting continuously?

When the compressor exhausts while running, ensure that the air line connections to the ECU are correct. The ECU has a supply and exhaust line. If the unit is connected backwards, the ECU will attempt to reach pressure, but won't since the connection is improper. If the issue persists after confirming proper connection, check the valves next. The valve could have debris which is not allowing the valves to properly close. If shop air is available, engage the valves with air to free the valves of debris. If the issue persists, please contact tech line for warranty claim.

11) Why does my compressor turn on and run by itself while driving?

If the compressor turns on by itself while the vehicle is in motion and continuously runs, there is a relay that is energized by the battery, and there is a potential wiring harness connection problem. It is possible that the ground terminal of the harness is improperly connected, or has become loose. Please check the connections of the harness to ensure that all terminals are properly connected. If all connections are secure and properly connected, please check the integrity of the relay connection to the compressor. It may be possible that the relay is failing or has failed.

12) Why does my compressor still run when I turn the key off, even when wired to an ignition source?

Please confirm that the following are connected correctly:

- A: The yellow ignition wire is properly connected to the correct fuse that connects to a switched source. There are some fuses that are always powered even when the vehicle's ignition is turned off.
- B: The red power wire is properly connected to the battery, preferably directly to the battery terminal to ensure that the relay is properly energized and reenergized during turn-on, turn-off cycles.
- C: The black wire is properly attached to a ground path. A direct battery connection to the negative terminal is preferred.

13) Why does my compressor run, but dead heads at the ECU?

The compressor usually stops operating if there is an improper connection to the valve body inlets and outlets. If your compressor runs momentarily and then stops, please check the following:

- A: The battery on the vehicle is in good working condition. It has been observed that batteries with insufficient capacities have been unable to withstand compressor demands. Please check your compressor's power rating, and confirm that the battery can meet the voltage and current demands.
- B: Please confirm that the air lines are connected to their proper inlet or outlet valves. This will enable the compressor to properly operate as demanded by the user's input.

14) Why does my controller show a completely different pressure than what is actually in the bags?

When the controller shows a completely different pressure, please contact our tech line for a warranty claim. The ECU contains pressure sensor which can be faulty. Since the sensors are inside the ECU, the unit needs to be replaced.

10

TEST THE SYSTEM

With the Air Command™ F3 Kit and your Air Springs installed, you are ready to test the system.

- 1 Reattach the negative battery cable.

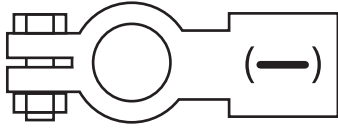

- 2 Turn on your vehicle's ignition.

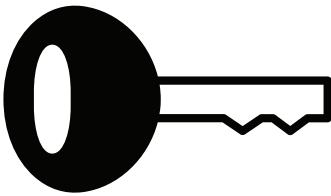

- 3 Use the Wireless Controller to inflate the Air Springs to 70 PSI. See Step 8 for details.

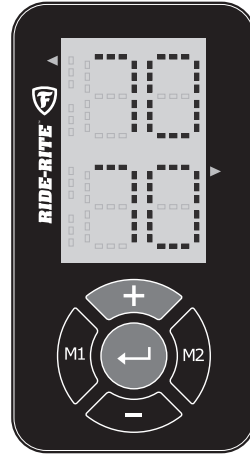

- 4 Spray fittings with soap and water mixture or glass cleaner.



- 5 Observe bubbles.

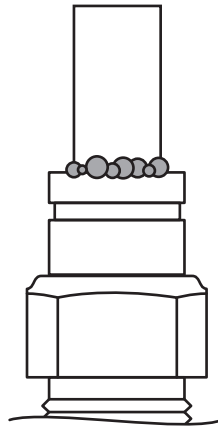

**SMALL SOAP BUBBLES
THAT DO NOT EXPAND**

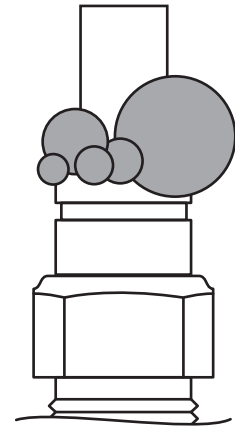

**SOAP BUBBLES
THAT EXPAND**



NO LEAKS?

Congratulations! You're riding right with the push of a button! Remember to review the Operating Instructions.

LEAK?

Bummer. Continue to Step 11 to fix the leak.



EXHAUST ALL AIR FROM THE SYSTEM PRIOR TO RELEASING AIR TUBES FROM AIR FITTINGS.



- 1 Use the Wireless Controller to deflate the Air Springs to 5 PSI. See Step 8 for details.

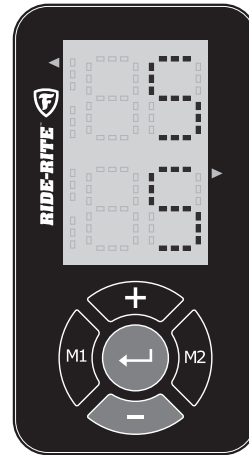

LEAK AT AIR LINE TUBE AND AIR FITTING

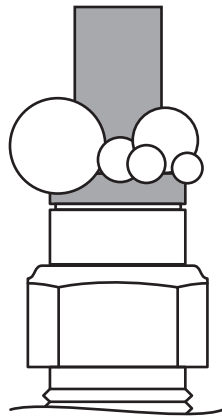

Release Air Line Tube (see page 4). Review proper cuts and procedures in Step 5. Repeat Step 5.

LEAK AT BASE OF AIR FITTING

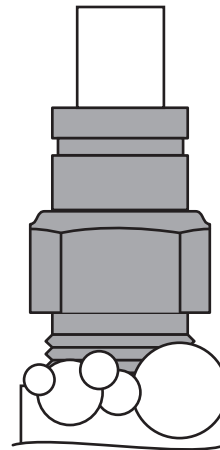

Tighten Air Fitting one turn or until leak stops.

STILL HAVE A LEAK?

Refer to the Troubleshooting section of the Instruction Manual. If the leak persists, or if there is an issue with a leaking part, call 1-800-888-0650; Option 1; Option 1 for Tech Support.



riderite.com

BEFORE YOU DRIVE, CONFIRM THE FOLLOWING:

- Secure all Air Line Tubes and wiring.
- The system passes the leak test and holds air.
- The Air Compressor ground ring terminal is contacting bare metal, and coated with silicone if possible.
- The Wire Harness is grounded to the negative (-) battery terminal. The ECU needs a good, clean, interference-free ground.
- There is a loop in the Air Line Tubes as shown to prevent water or debris from getting into the Air Compressor head and damaging it.

NEED INSTALLATION HELP? 1-800-888-0650

Select Option 1 for Ride-Rite; Select Option 1 for Technical Support.

Or, email us at rrtech@fsip.com. If emailing, please include photos to help us better diagnose and understand any problems you may be experiencing.



CONNECT WITH US



@rideriteair



@rideriteair



Firestone RideRite



Firestone Ride-Rite

USING THE IGNITION FUSE TAP

1 Insert the fuse for the Firestone accessory port, as shown.

2 Use your vehicle's Owner's Manual to determine a safe and suitable ignition fuse and remove the fuse, noting its location. This location should register **between 11.8 VDC and 15 VDC** when testing with a multimeter, as noted below.

3 Insert the removed fuse from your vehicle into the lower Fuse Tap port, as shown.

4 Plug the Fuse Tap into the fuse port on the vehicle, matching the hot and load sides, as shown. **DO NOT REVERSE.**

