

PARTS LIST:

| Qty | Description | Qty | Description |
|-----|---|-----|------------------------------------|
| 1 | Grille Guard Assembly | 4 | 12-1.75mm Nylon Lock Nut |
| 1 | Driver/Left Frame Bracket | 8 | 10-1.5mm x 30mm Button Head Bolt |
| 1 | Passenger/Right Frame Bracket | 16 | 10mm x 24mm OD x 2.2mm Flat Washer |
| 1 | Driver/Left Grille Guard Mounting Bracket | 8 | 10-1.5mm Nylon Lock Nut |
| 1 | Passenger/Right Grille Guard Mounting Bracket | 2 | 8-1.25mm x 25mm Button Head Bolt |
| 1 | Driver/Left Top Bracket (Outer) | 4 | 8-1.25mm x 25mm Hex Bolt |
| 1 | Driver/Left Top Bracket (Inner) | 12 | 8mm x 22mm OD x 2mm Flat Washer |
| 1 | Passenger/Right Top Bracket (Outer) | 6 | 8-1.25mm Nylon Lock Nut |
| 1 | Passenger/Right Top Bracket (Inner) | 4 | 6-1.0mm x 25mm Hex Bolt |
| 2 | Top Support "U" Rear Plate | 4 | 6mm x 18mm OD x 1.6mm Flat Washer |
| 4 | 12-1.75mm x 35mm Bolt Plate | 4 | 6mm Lock Washer |
| 4 | 12mm x 32mm OD x 3mm Flat Washer | | |

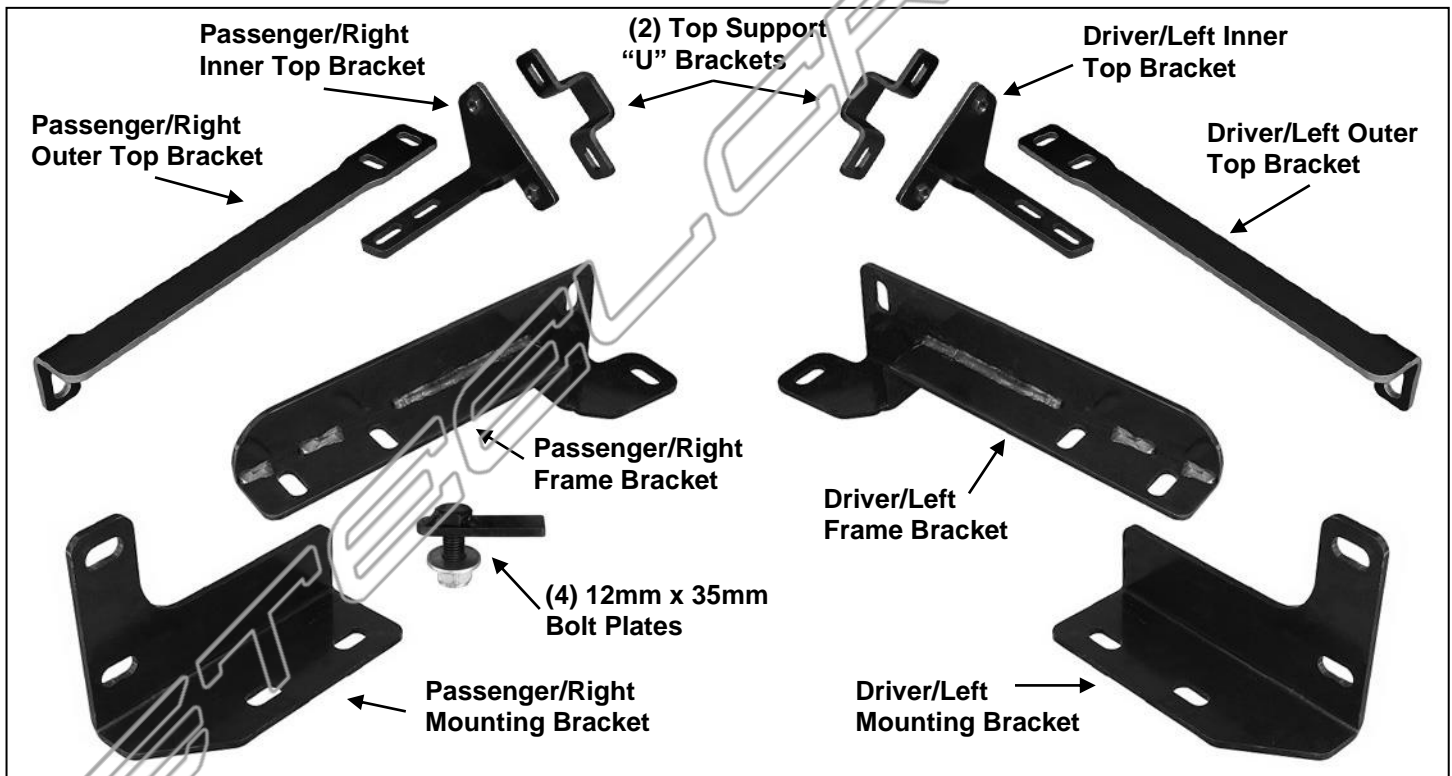

PROCEDURE:

REMOVE CONTENTS FROM BOX AND VERIFY ALL PARTS ARE PRESENT. READ INSTRUCTIONS CAREFULLY. DO NOT ATTEMPT INSTALLATION ALONE; PERSONAL INJURY OR DAMAGE TO THE VEHICLE MAY RESULT. CUTTING MAY BE REQUIRED. ASSISTANCE IS HIGHLY RECOMMENDED. GRILLE GUARD INSTALLATION MAY INTERFERE WITH FRONT MOUNTED SENSORS.

1. Start installation at the front, passenger side of the vehicle. Determine if the vehicle is equipped with tow hooks, **(Figure 1)**.

Tow Hook equipped vehicles:

- a. Remove the factory tow hooks from the end of each frame channel, **(Figure 2)**. **NOTE:** Tow hooks cannot be reinstalled with the Grille Guard.

Vehicles without tow hooks:

- a. Cut out the indented area in both sides of the plastic bumper to clear the Brackets only.

IMPORTANT: Make several small cuts for best fit. .

2. Select (2) 12mm Bolt Plates, **(Figure 3)**. Insert the Bolt Plates into the end of the frame channel and out through the holes in the bottom and outer side of the frame, **(Figure 4)**.
3. Next, select the passenger side Frame Bracket, **(Figure 5)**. Insert the Bracket through the opening in the plastic bumper, **(Figure 6A)**. Line up the (2) holes in the Bracket with the Bolt Plates. Secure the Bracket to the Bolt Plates with (2) 12mm Flat Washers and (2) 12mm Nylon Lock Nuts, **(Figure 6B)**. Do not tighten hardware at this time.
4. Next, select the passenger side Mounting Bracket, **(Figure 7)**. Bolt the Mounting Bracket to the bottom of the Frame Bracket with (2) 10mm x 30mm Button Head Bolts, (4) 10mm Flat Washers and (2) 10mm Nylon Lock Nuts, **(Figure 8)**. Do not tighten hardware at this time.
5. Repeat **Steps 2—4** to install the driver side Frame and Mounting Brackets.
6. Next, open the hood and remove the plastic cover between the top of the grille and the radiator, **(Figure 9)**. **NOTE:** Use a small flat head screw driver to pop up the center of the plastic clips. Remove the hardware securing the outer ends of the grille to the vehicle. Carefully pull the grille out to release it from the clips with the top of the grill tilted forward, **(Figure 10)**. It is not necessary to remove the grille, only tilt the top forward to access the area between the grille and the radiator.
7. Locate the square tube support braces running up at an angle from the top of the frame channel to the bottom of the hood release mechanism, **(Figure 11)**. Select the passenger side Inner Top Bracket and (1) "U" Backing Plate, **(Figure 12)**. Hold the "U" Bracket up to and around the back of the square tube, **(Figure 13)**. Bolt the Inner Top Bracket to the "U" Bracket with (2) 6mm x 25mm Hex Bolts, (2) 6mm Lock Washers and (2) 6mm Flat Washers, **(Figure 14)**. Leave loose at this time.
8. Select the passenger side Outer Top Bracket, **(Figure 12)**. Insert the Outer Bracket through the grille and up to the Inner Top Bracket assembly, **(Figure 15)**. Bolt the Outer Bracket to the top of the Inner Bracket with (2) 8mm x 25mm Hex Bolts, (4) 8mm Flat Washers and (2) 8mm Nylon Lock Nuts. **NOTE:** Slide the Bracket assembly up or down the square tube to match up with the Outer Top Bracket. Leave hardware loose at this time.
9. Repeat **Steps 7 & 8** for driver side inner and outer Top Bracket installation.
10. With assistance, hold the Grille Guard up in position on the outside of the Mounting Brackets. Bolt the Grille Guard to the Brackets with (4) 10mm x 30mm Button Head Bolts, (8) 10mm Flat Washers and (4) 10mm Nylon Lock Nuts. **(Figure 16)**. Do not tighten hardware at this time.
11. Line up the outer bent end of the Top Bracket with the hole in the Grille Guard upright. Bolt the Top Bracket to the upright with (1) 8mm x 25mm Button Head Allen Bolt, (2) 8mm Flat Washers and (1) 8mm Nylon Lock Nut, **(Figure 17)**.
12. Level and adjust the Grille Guard and fully tighten all hardware. **IMPORTANT:** Adjust the position of the Top Brackets up or down as required so that they cannot come in contact with the plastic grille, **(Figures 15 & 17)**.
13. Push the grille back into position and into the clips and secure with the factory hardware. Reinstall the top plastic cover using the factory hardware.
14. Do periodic inspections to the installation to make sure that all hardware is secure and tight.

To protect your investment, wax this product after installing. Regular waxing is recommended to add a protective layer over the finish. Do not use any type of polish or wax that may contain abrasives that could damage the finish.

For stainless steel: Aluminum polish may be used to polish small scratches and scuffs on the finish. Mild soap may be used also to clean the Extreme Grille Guard.

For gloss black finishes: Mild soap may be used to clean the Extreme Grille Guard.

Passenger Side Installation Pictured



(Fig 1) Opening for tow hook pictured

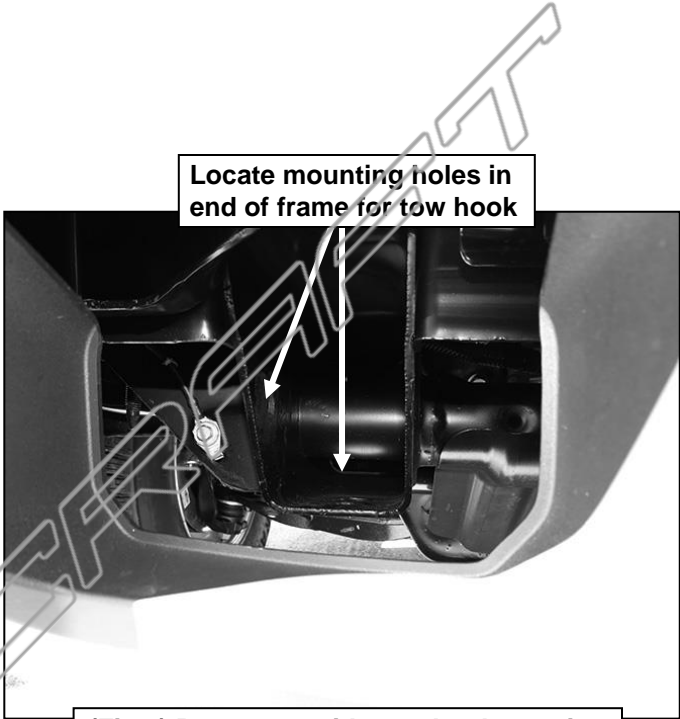

(Fig 2) Passenger side tow hook opening



(Fig 3) 12mm Bolt Plate

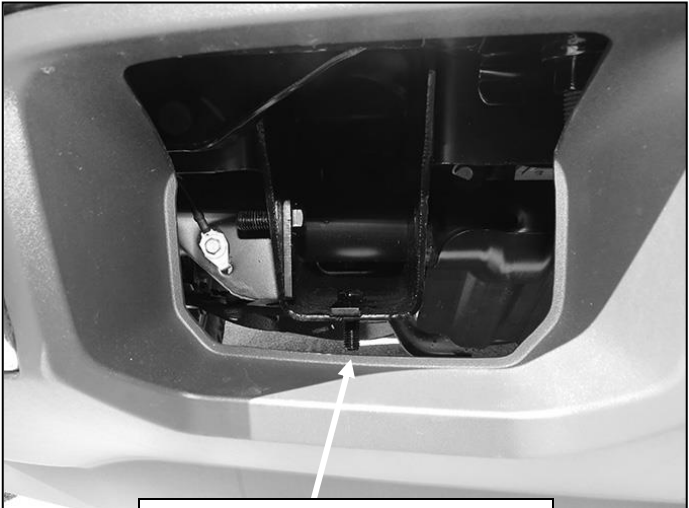

(Fig 4) Insert Bolt Plates through holes in end of frame



(Fig 5) Passenger/right Frame Bracket

Passenger Side Installation Pictured

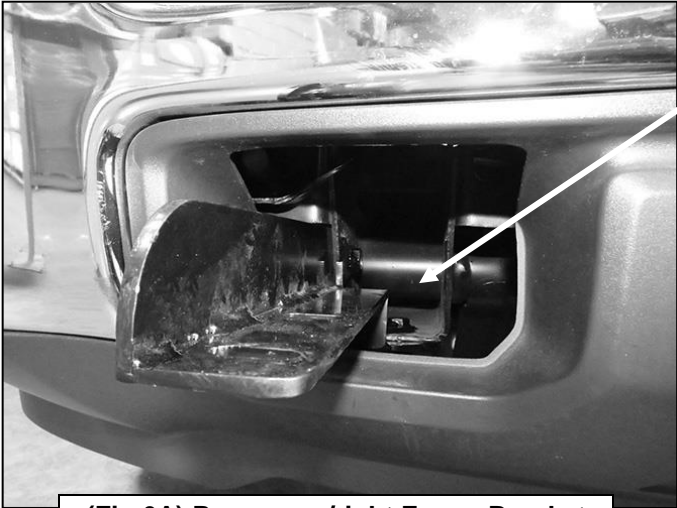

- (2) 12mm Bolt Plates
- (2) 12mm Flat Washers
- (2) 12mm Nylon Lock Nuts

(Fig 6A) Passenger/right Frame Bracket

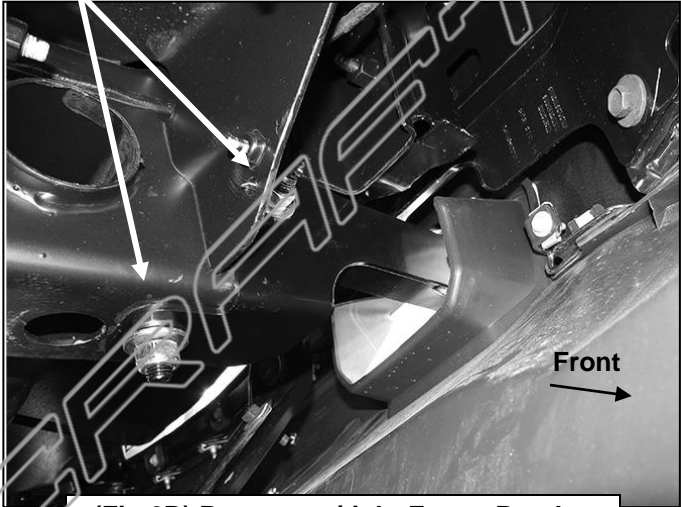

(Fig 6B) Passenger/right Frame Bracket



(Fig 7) Passenger/right Mounting Bracket

- (2) 10mm Button Head Bolts
- (4) 10mm Flat Washers
- (2) 10mm Nylon Lock Nuts

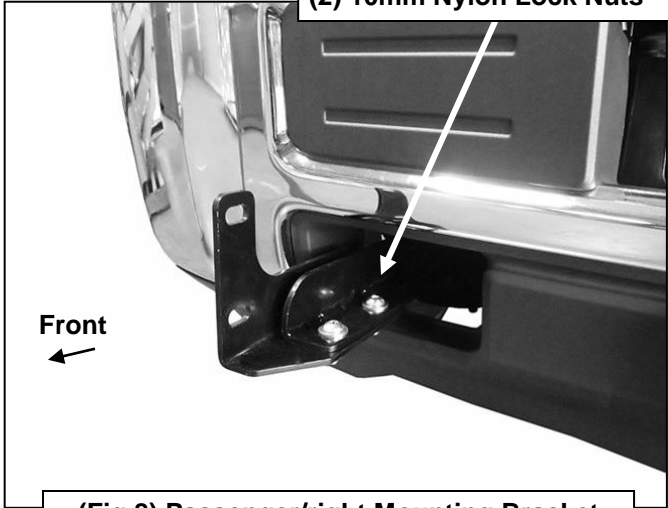

(Fig 8) Passenger/right Mounting Bracket

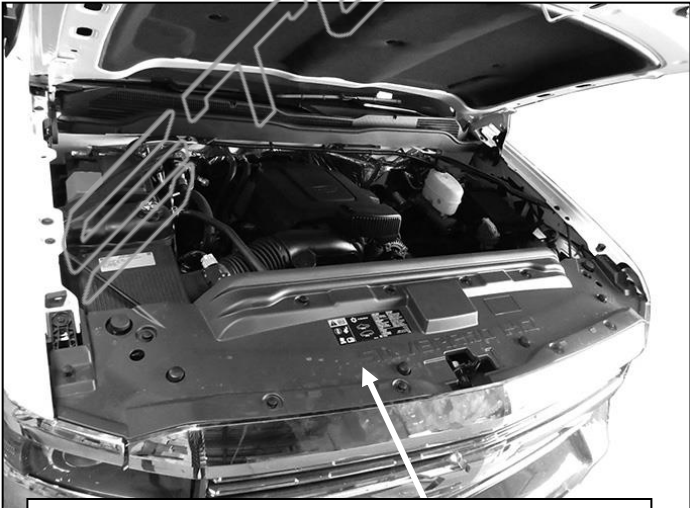

(Fig 9) Remove plastic cover on top of grille

Passenger Side Installation Pictured

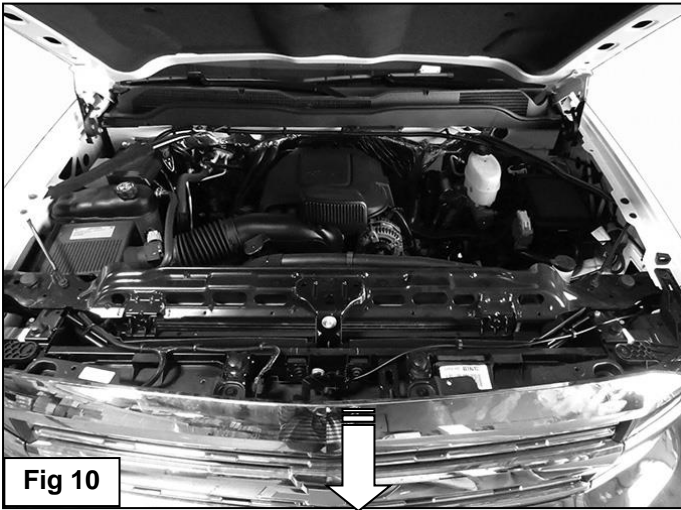

Remove hardware securing grille to vehicle. Carefully pull the grille straight out from the vehicle. Tilt the top of the grille forward only to access the area behind the grille

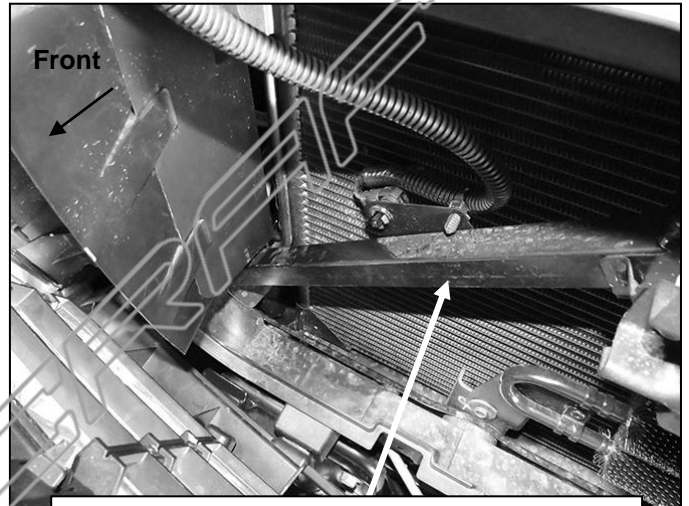

(Fig 11) Passenger side square tube support between grille and radiator pictured

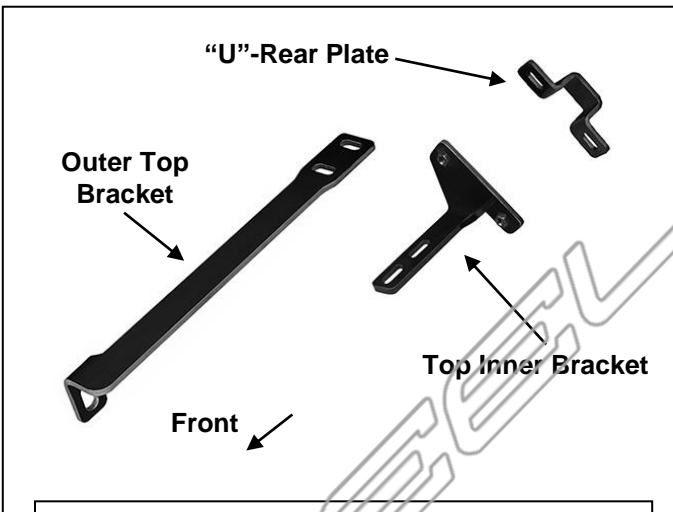

(Fig 12) Passenger side top Brackets pictured

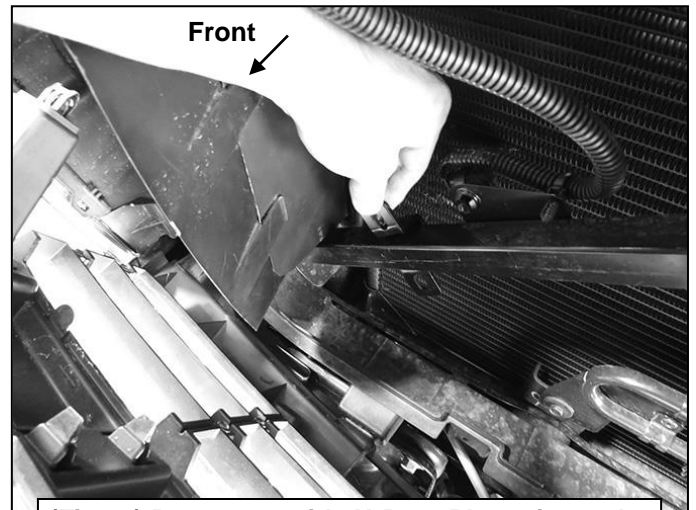

(Fig 13) Passenger side U-Rear Plate pictured

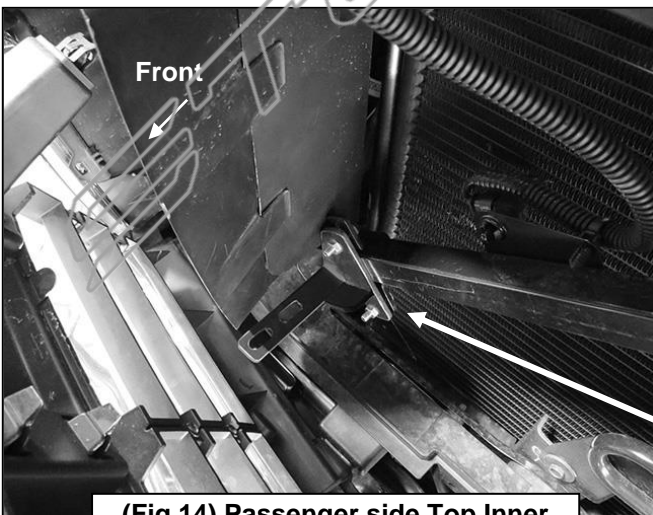

(Fig 14) Passenger side Top Inner Bracket and U Rear Plate pictured

- (2) 6mm x 25mm Hex Bolts**
- (2) 6mm Lock Washers**
- (2) 6mm Flat Washers**

Passenger Side Installation Pictured

- (2) 8mm x 25mm Hex Bolts
- (4) 8mm Flat Washers
- (2) 8mm Nylon Lock Nuts

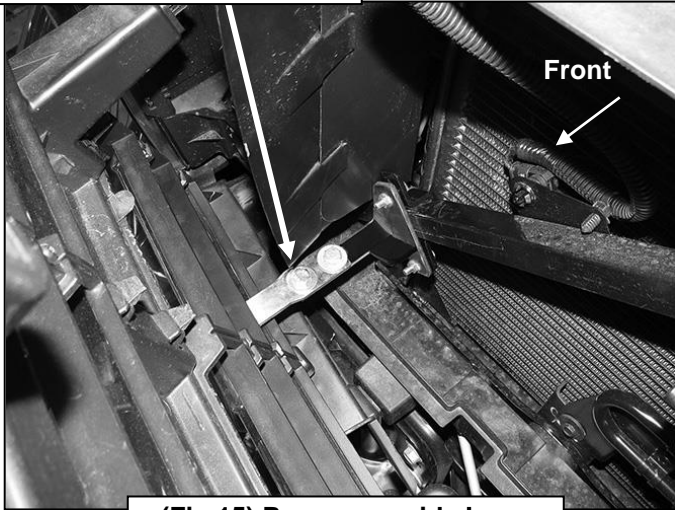

(Fig 15) Passenger side Inner and Outer Bracket pictured

- 8mm x 25mm Button Head Bolt
- 8mm Flat Washer
- 8mm Nylon Lock Nut



(Fig 17) Passenger side Top Bracket installation pictured. Adjust position so that Bracket cannot come in contact with plastic grille

- (2) 10mm Button Head Bolts
- (4) 10mm Flat Washers
- (2) 10mm Nylon Lock Nuts

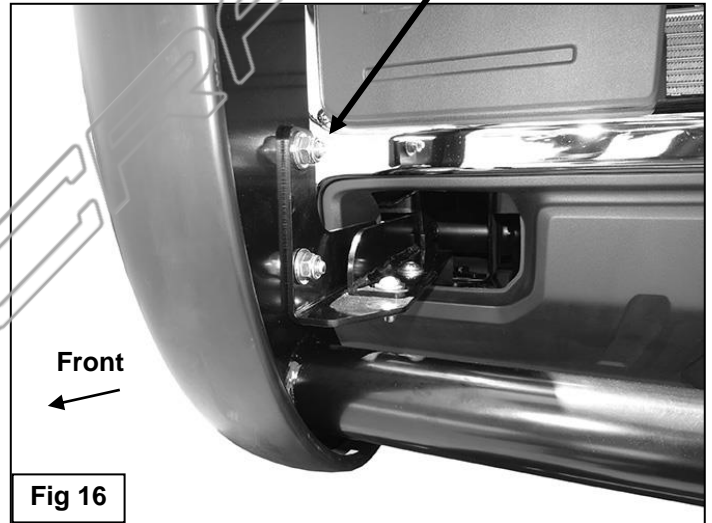

Fig 16

Complete Installation

