



INSTALLATION INSTRUCTIONS

Single Compartment Overhead Console #103

Please read and fill out the enclosed warranty registration card to activate your warranty.

Shipment Contents



103 Loop Bracket
(For wranglers 03+)



Footman Loop Bracket
(For wranglers 01-02)



Electronics Support Frame



Adjustable Support Bracket



Lower Adjustment Piece



Upper Adjustment Piece



Main Console Body

Shipping Package



(4)6-32 Flathead Phillips

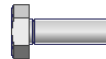

(2)6-32 Unslotted Screws



(2)10-32 Panhead Phillips



(2)10-32 Flat Phillips



(3)10-32 Button head Screws



(2)1/4-20x3/8 SocketHead Screws



(3)3/16" Washers



(2)1/4" Washers

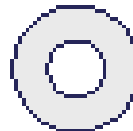

(4)5/16" Washers

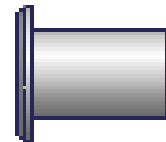

(2)5/16" Barrel Nuts

Shipping Package (Continued)



(2) 10-32 Lock Nuts

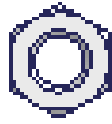

(4) 5/16" Lock Nuts

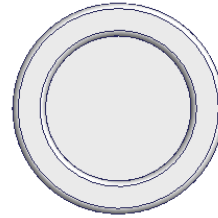

(2) 1" Diaphragm Grommets

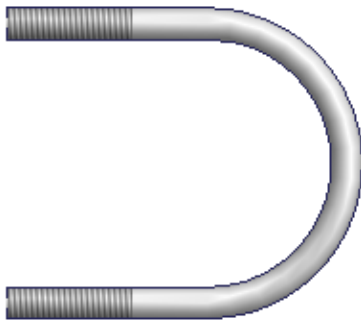

(2) 5/16" U-Bolts

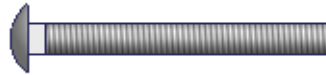

(2) 5/16-18x3" Carriage Bolts

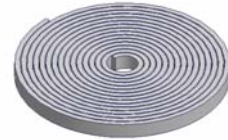

Rubber Seal

TOOLS NEEDED

- 1/8" Allen Wrench
- 3/16" Allen Wrench (Wranglers Pre 2003 without full roll cage only)
- T-20 Torx Driver (Wranglers Pre 2001 only)
- Small Phillips Screw Driver
- 5mm Allen Wrench
- 1/4" Socket
- 1/2" Socket and Ratchet – Extensions and Swivels are helpful (Vehicles with Roll Cage only)

PLEASE READ ALL INSTRUCTIONS THOROUGHLY BEFORE STARTING INSTALLATION.

These instructions will guide you through the installation of your new overhead console in the following vehicles:

- Stock Jeep Wranglers 2000 or earlier
- Stock Jeep Wranglers 2001-2002 (With Footman loop riveted to windshield)
- Stock Jeep Wranglers and Rubicons 2003+ (With Large Oval Roll bar Pad)
- Vehicles with a full roll cage and distance from front to rear bar between 28" to 36-1/2"

If your vehicle does not fall into one of these categories you may have to make modifications to mounting brackets, and/or purchase additional hardware.

1. Apply the Rubber Seal provided to the lid so that it will seal up against the console when closed. Check the lock operation.
2. Route the wires for your stereo, CB, or speaker up along the roll bar and leave plenty of extra wire.

Stock Jeep Wranglers 2000 or earlier

3. Remove the footman loop from the top center of the windshield frame using a T-20 torx wrench. Save all hardware.
4. Using (2)10-32x1/2" Flat Phillips machine screws and (2)10-32 Locknuts bolt the footman loop to the Lower Adjustment Piece as shown in Figure 1.

Stock Jeep Wranglers 2001-2002, Stock Jeep Wranglers and Rubicons 2003+, Vehicles with a full roll cage

5. If you have a bikini top or if you plan to get a bikini top, you will need to purchase a footman loop. Most large hardware stores have footman loops in stock- You will need one with hole spacing of 2-1/4" center to center.
6. Using (2)10-32x1/2" Flat Phillips machine screws and (2)10-32 Locknuts bolt the footman loop to the Lower Adjustment Piece as shown in Figure 1.

7. Refer to Figure 2 and place the Upper and Lower Adjustment pieces around the rear roll bar. Route the previously run electrical wires from the roll bar through them. Notice that the upper piece wraps outside of the lower piece on the top and sides. Also notice that that upper piece has nuts inserted, make sure that at the back of the two pieces that the upper piece is inside the lower piece, See Figure 3.
8. Using the (2) 10-32x3/8" Panhead Phillips Machine Screws, loosely screw the two pieces together as shown in Figure 3.

Stock Jeep Wranglers 2000 or earlier, Stock Jeep Wranglers 2001-2002, Vehicles with a full roll cage

9. Insert the 3" Carriage bolts through the Upper Adjustment Piece as shown in Figure 4. These will be tightened later in the installation.

10. Route the wires through either of the side passageways on the console body to where the electronic equipment will be mounted. Angle the rear portion, previously mounted to the roll bar, toward the floor at about 45 degrees. Carefully slide the console body over the previously mounted rear portion.

Stock Jeep Wranglers 2000 or earlier

11. Carefully rotate the console up until the holes in the front of the console line up with the holes in the windshield frame where the footman loop was. Use the original footman loop hardware to bolt the console to the windshield frame. **BE CAREFUL NOT TO TEAR THE ROLL BAR PADDING!**

Stock Jeep Wranglers 2001-2002

12. Slip the footman loop bracket around the existing footman loop by inserting the bent flange on the bracket behind the footman loop from the top down. Carefully rotate the console up until the holes in the front of the console line up with the holes in the footman loop bracket. **BE CAREFUL NOT TO TEAR THE ROLL BAR PADDING!** Use the (2)1/4-20x3/8" Socket Head Cap Screws and (2)1/4" Washers to fasten the console to the bracket. See Figure 5.

Stock Jeep Wranglers and Rubicons 2003+

13. Place the 103 Loop Bracket over the hook at the top center of the windshield frame. Carefully rotate the console up until the holes in the front of the console line up with the holes in the Loop Bracket. **BE CAREFUL NOT TO TEAR THE ROLL BAR PADDING!** Using the (2)1/4-20x3/8" Socket Head Cap Screws and (2)1/4" Washers bolt the console to the bracket. Using (1)10-32x1 Button Head Screw and (1) 3/16" Washer bolt the console through the hook to the Loop Bracket. Tighten until snug. See Figure 6.

Vehicles with a full roll cage

14. Carefully rotate the console up until you can use the (2)5/16" U-Bolts, (4)5/16" Washers, and (4) 5/16" Locknuts to bolt the console to the front roll bar.
15. Use (2)10-32x1 Button Head Screws and (2)3/16" Washers to bolt the rear assembly to the main console. There are nuts in the top of the console that these screws will go into. **Do not over tighten.** Over tightening will cause the top of the console to warp down. See Figure 7.

Stock Jeep Wranglers Pre 2000, Stock Jeep Wranglers 2001-2002, Vehicles with a full roll cage

16. Using the (2) 5/16" Barrel Nuts tighten down the rear assembly around the roll bar. Be sure to slide the bolts as far back as possible up against the roll bar.
17. Tighten the screws that you inserted in Step 10.
18. Mount the Stereo, CB, or speaker to the removable electronics support frame if desired or your electronic equipment can be fastened directly to the console. Notice that there are holes on the back flange of the bracket for securing a stereo support strap or similar support device.
19. Follow the manufacturer's directions for connecting the supply wires to your electronic equipment.
20. Slide the Support Frame up into the lockable compartment (you will have to rotate the cam lock while inserting the bracket) and fasten in place using (2)6-32 Flat head Phillips Machine Screws on the face of the bracket and (2)6-32 Unslotted Hex washer Screws up through the bottom of the console into the bracket. Do not over tighten, these small diameter screws cannot withstand a lot of torque and will break if over-tightened. See Figure 8.
21. Use the Adjustable Stereo/CB Support Bracket and (2)6-32 Flat Head Phillips Machine Screws to secure the top of your electronic equipment.
22. Install the 1" Grommets in the holes on both sides of the console. If you need to route a CB microphone or other cables through the hole simply slice the middle of the grommet.
23. Lock it up!!

Call (970) 564-1762 for Technical Support

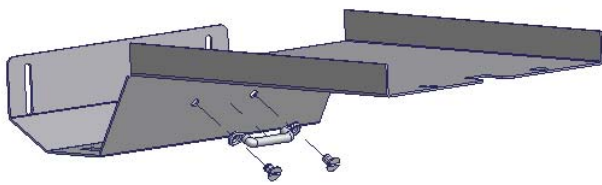

FIGURE 1

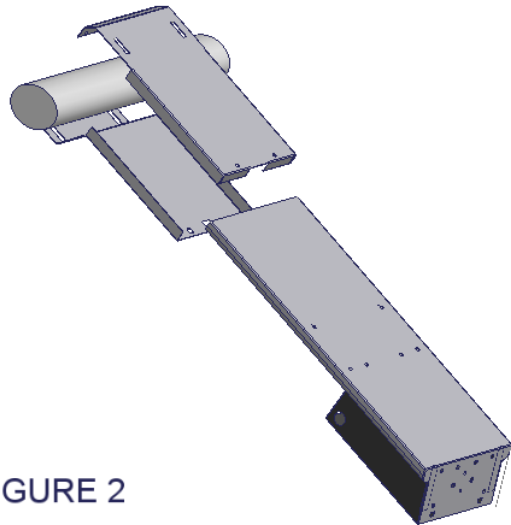

FIGURE 2

