



**Installation Instructions**

**BR10 Front Bumper Replacement Part Number 24273T**

**2015-2016 Chevrolet Silverado 2500HD & 3500HD 2/4WD (Excludes models with Driver Alert Package)**

Do not attempt to install this product on any vehicle other than the one listed above!

**Parts List**

Item	Qty.	Part #	Description	Item	Qty.	Part #	Description	Torque
1	1	24273T	Bumper Replacement Shell	11	12		1/2" x 1 1/2" Hex Bolt	65 ft. lbs.
2	1		Passenger Side Frame Bracket	12	6		1/2" x 1 1/2" Carriage Bolt	65 ft. lbs.
3	1		Driver Side Frame Bracket	13	20		1/2" Flat Washer	
4	2		Spacer Plate	14	18		1/2" Lock Washer	
5	1		Driver Side Vent Cover	15	12		1/2" Hex Nut	
6	1		Passenger Side Vent Cover	16	38		1/4" x 3/4" Button Head Bolt	71 in. lbs.
7	1		Winch Cover	17	10		1/4" Nylon Lock Nut	
8	2		Light Pod Plate	18	6		3/8" x 1 1/4" Hex Bolt	30 ft. lbs.
9	1		License Plate Bracket	19	6		3/8" Lock Washer	
<b>Required for Installation (Sold Separately)</b>				20	6		3/8" Flat Washer	
10	1	24273TW	Mounting Plate/Winch Tray	21	6		3/8" Hex Nut	
				22	4		Hole plug	

**ILLUSTRATION #1**

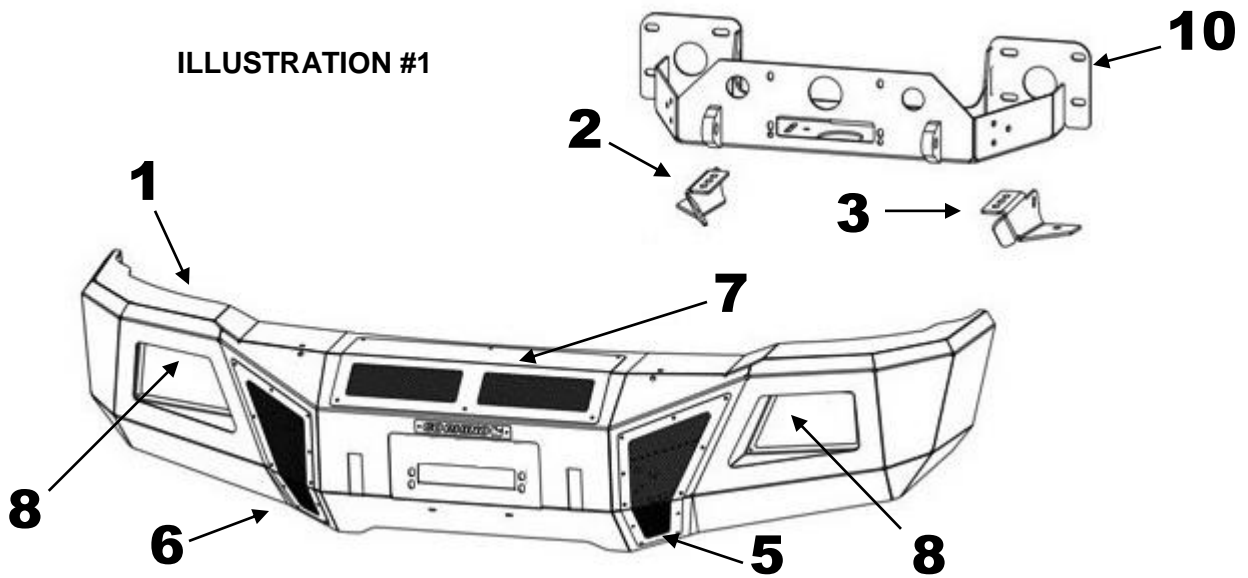

**Tool Required:**

7mm, 10mm, 15mm, 18mm, 21mm, 7/16", 9/16" & 3/4" Sockets  
18mm, 7/16", 9/16" & 3/4" Wrenches  
Slotted Blade Screw Driver  
5/32" Hex Key  
Ratchet, Ratchet Extensions & Swivel Joint Adapter

**Approximate installation time: 90 min.**

**IMPORTANT INSTALLATION NOTES AND SUGGESTIONS**

The pre-installed Mesh Winch and Vent Covers need to be removed using hand tools to slowly remove the bolts. Using an air assisted impact or ratchet will damage the bolt threads and the internal nut assembly in the bumper shell. Use of an appropriate anti-seize compound is highly recommended for re-installation, and tighten the bolts to the specified torque as overtightening could result in difficulty of future removal.

To maintain and care this product keep it clean and do not use abrasive cleaners or polish waxes. **Texture Painted Finish:** Mild liquid detergent may be used. **Polished Stainless & Semi-Gloss Painted Finishes:** We recommend using only non-abrasive automotive wax such as pure carnauba to avoid scratches and rust.

Read the installation instructions completely and verify that all of the parts listed are accounted for. If you have defective, missing or damaged parts or need assistance, please contact Go Rhino Products for fast, friendly customer service at: (888) 427-4466 or email: [sales@gorhino.com](mailto:sales@gorhino.com)

**Front Bumper Removal**

**Step-1** Open the hood and locate the (12) plastic push pins (6) per side securing the radiator cover. Using a flat blade screw driver, pull the head of the push pins up, remove push pins and lift radiator cover off. This will allow access to the bolts securing the top of the grille, (Photo 1).

**Step-2** Remove the (4) screws (2) per side securing the top of the grille, (Photo 2).

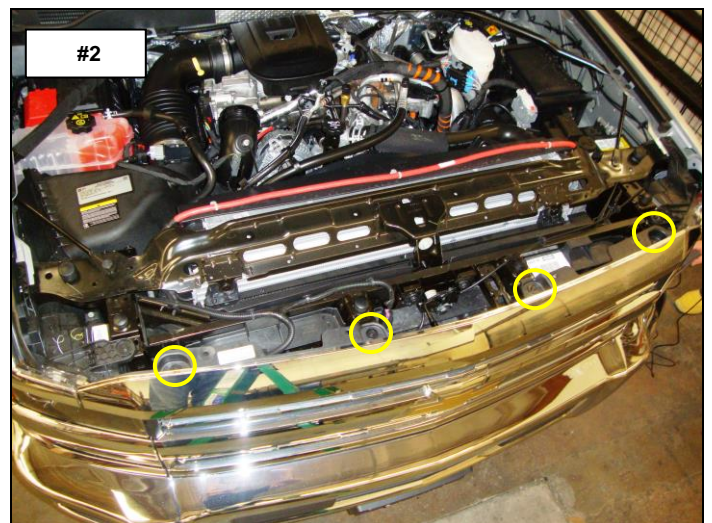
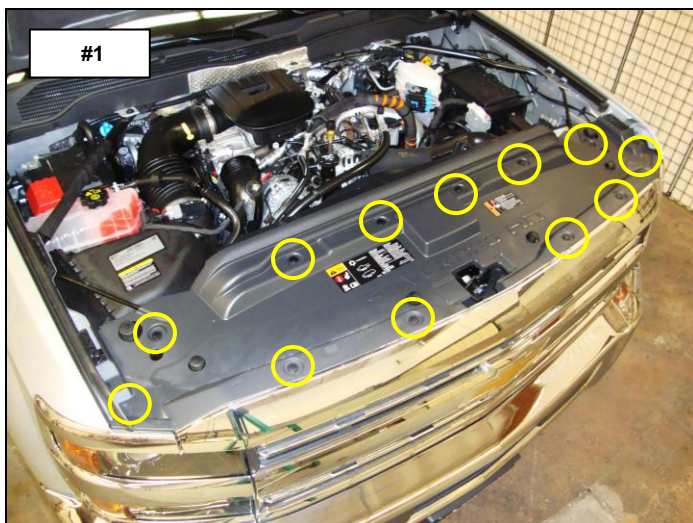

**Step-3** Working from side to side gently pull outward to unsnap the clips and remove the grille, (Photo 3).

**Step-4** Disconnect the bumper electrical harness from vehicle, (Photo 4).

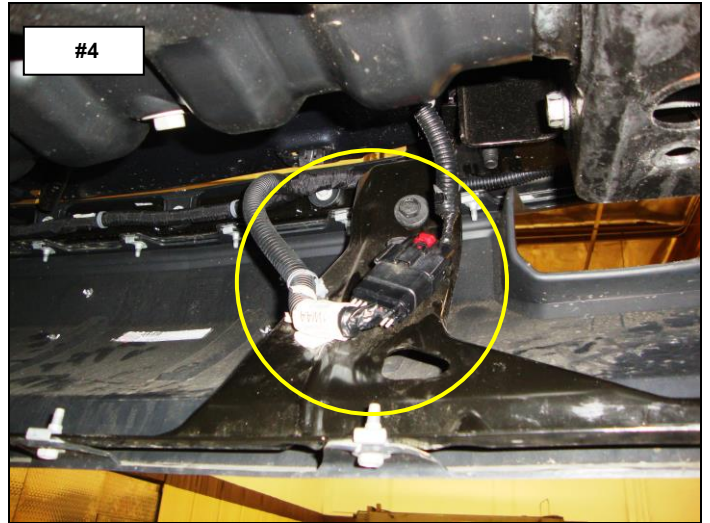
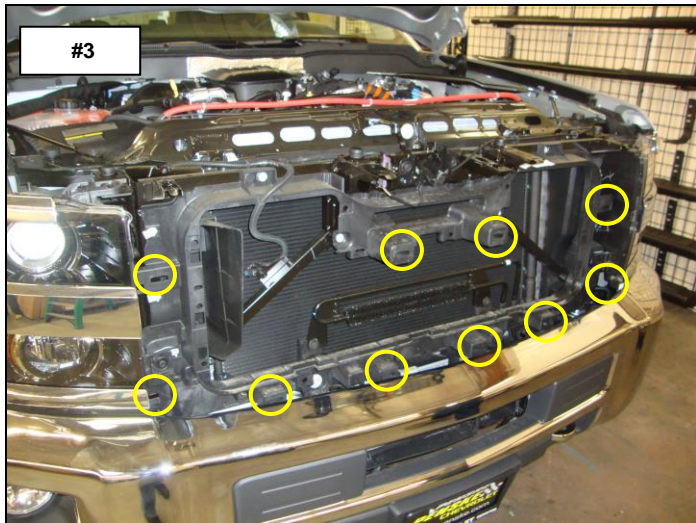

**Step-4** On each side of the vehicle, remove the bolt securing the outer bumper support bar to the bumper and loosen the (2) bolts securing the opposite end of the support bar to the frame body mount bracket, (Photo 5).

**Step-5** With assistance support the bumper, and remove the bolts (4) per side securing the bumper and bracket assembly to the frame. Remove the bumper from the vehicle, (Photo 6). Retain the factory bolts to attach the winch tray to the vehicle.

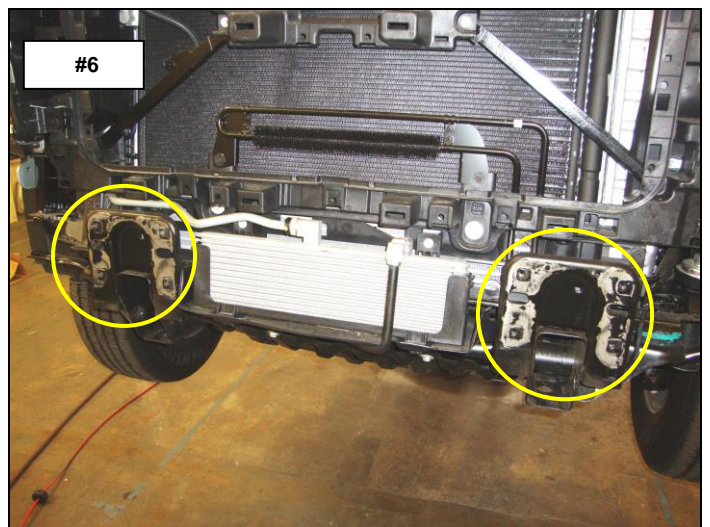
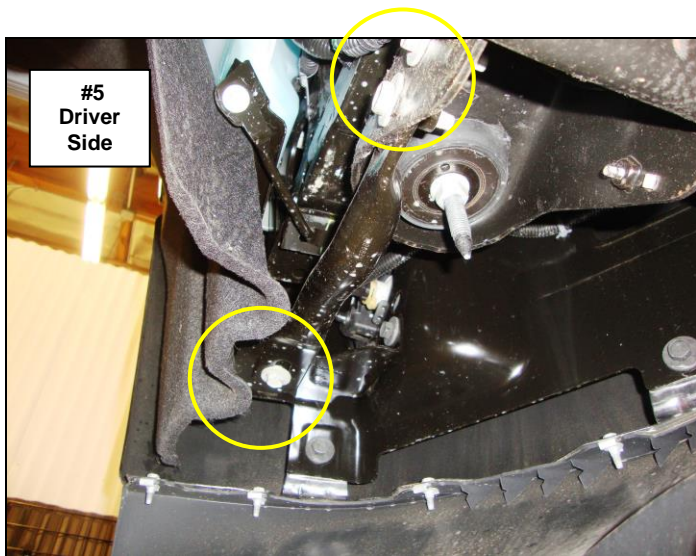

## BR10 Bumper Replacement Installation

**Step-1** Remove the nuts bolts and tow hook from the frame, (Photo 7). Note: The tow hook will not be reinstalled.

**Step-2** Install the driver's side frame bracket by positioning the bracket on the side and bottom of the frame, align the holes and secure the bracket to the frame using (2)  $\frac{1}{2}$ " x  $1\frac{1}{2}$ " hex bolts, (2)  $\frac{1}{2}$ " flat washers, (2)  $\frac{1}{2}$ " lock washers and (2)  $\frac{1}{2}$ " hex nuts, (Photo 8). Leave the nuts and bolts loose for final adjustment. Repeat this step to install the passenger side frame bracket.

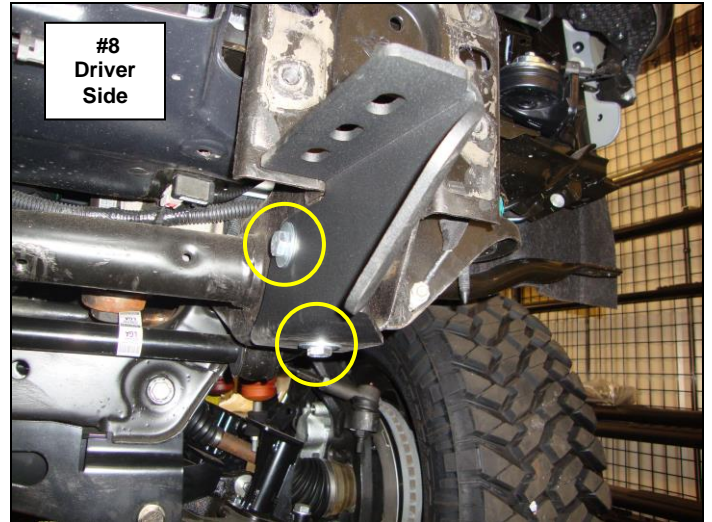
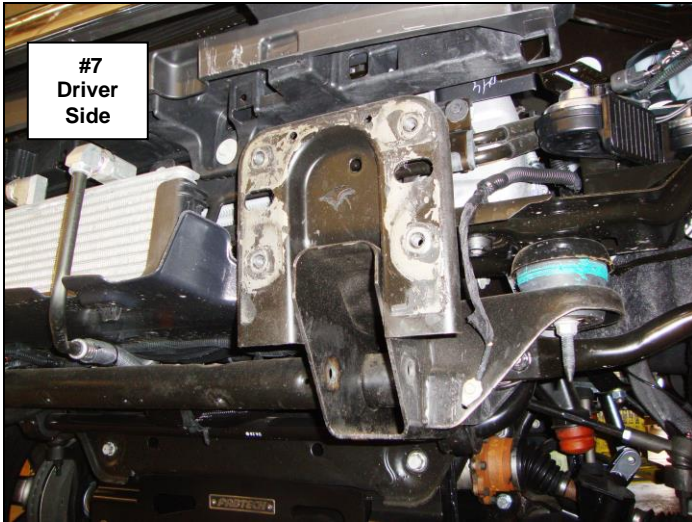

**Step-3** Rest the winch tray on top of the frame brackets. Position one of the spacer plates between the winch tray mounting flange and frame, align the spacer plate with the (2) upper holes in the frame and winch tray mounting flange and reinstall the (4) factory bolts. Position the remaining spacer plate between the winch tray flange and frame on the passenger side and reinstall the factory bolts. Secure the winch tray to each frame bracket using (3)  $\frac{1}{2}$ " x  $1\frac{1}{2}$ " carriage bolts, (3)  $\frac{1}{2}$ " flat washers, (3)  $\frac{1}{2}$ " lock washers and (3)  $\frac{1}{2}$ " hex nuts, (Photo 9 & 10). Leave the nuts and bolts loose for final adjustment.

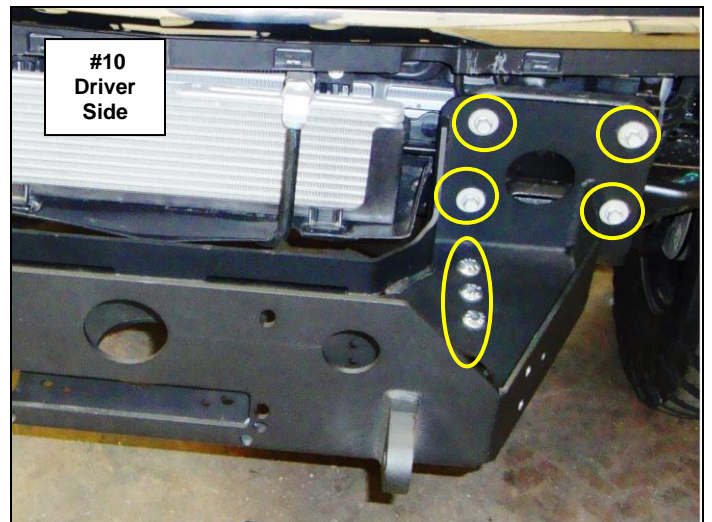
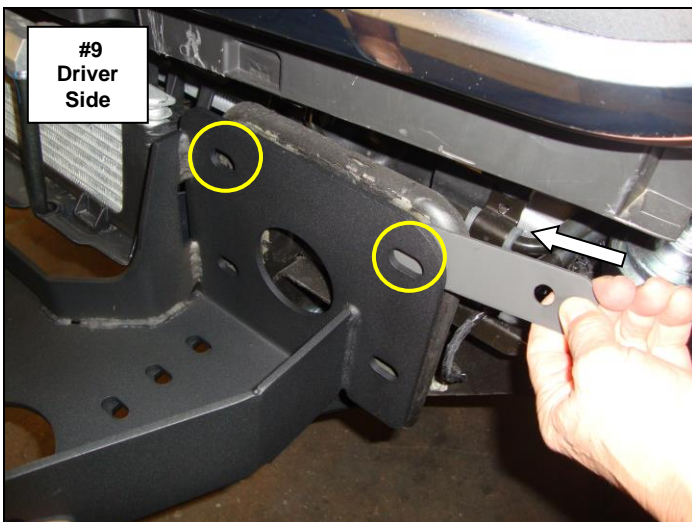

**Step-4** Use a reference point on the vehicle, measure and adjust the winch tray so the side to side alignment on the vehicle is equal, then finger tighten all factory and supplied nuts and bolts securing the winch tray and frame brackets, (Photo 11 & 12).

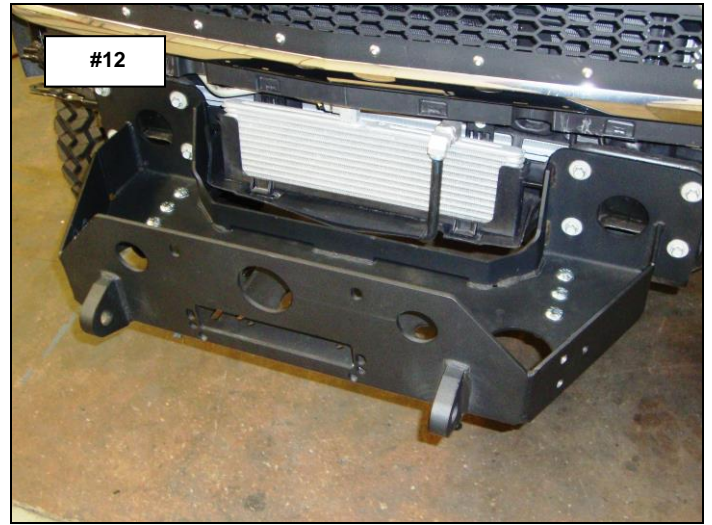

If you are installing a winch, place the winch in the winch tray and refer to the winch manufacturer's instructions for installation. Do not install the fairlead at this time.

**Step-5** With assistance lift the bumper shell up to the vehicle, align the holes in the bumper brackets with the weld nuts on the winch tray and secure the bumper shell brackets to each side of the winch tray using (3)  $\frac{1}{2}$ " x 1  $\frac{1}{2}$ " hex bolts, (3)  $\frac{1}{2}$ " lock washers and (3)  $\frac{1}{2}$ " flat washers, (Photo 13 & 14). Leave the bolts loose for final adjustment.

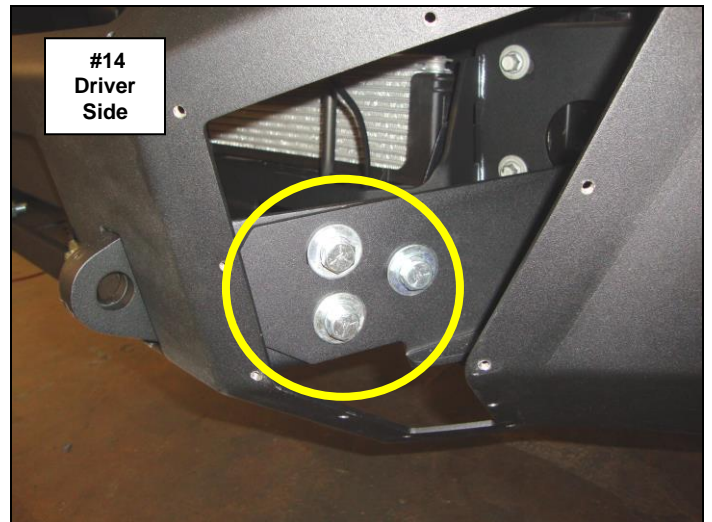

**Step-6** Align the holes and attach each factory bumper support bar to each of the bumper shell support brackets using (1) ½" x 1 ½" hex bolt, (2) ½" flat washers, (1) ½" lock washer and (1) ½" hex nut, (Photo 15).

**Step-7** Align the bumper shell with the vehicle and tighten all factory and supplied nuts and bolts, (Photo 16).

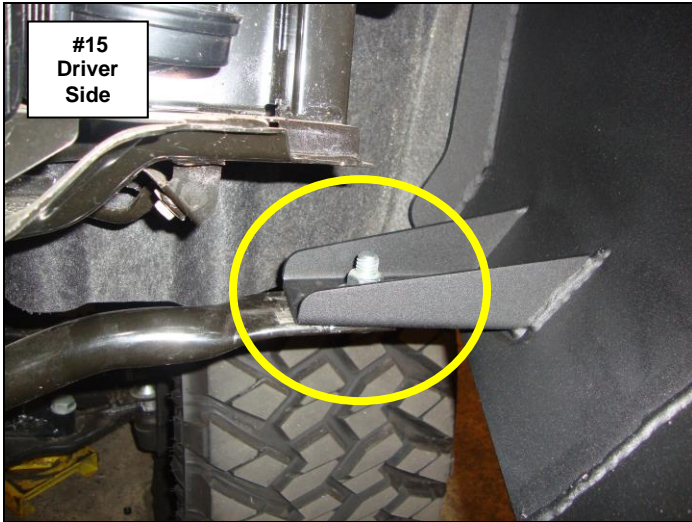

If installing a winch, install the roller fairlead to the bumper shell at this time. Refer to the winch manufacturer's instructions for installation. If installing an optional light bar, install the light bar to the bumper replacement at this time. Refer to the light bar instructions for installation.

**Step-9** Install the winch cover and driver and passenger side front vent covers to the bumper shell using the supplied ¼" x ¾" button head bolts, (Photo 17 & 18). **Note:** Do not over tighten bolts, reference tightening torque (71 In. lbs.).

**Step-10** Install the flush mount light pods to the bumper shell using (4) ¼" x ¾" button head bolts and (4) ¼" nylon lock nuts, (Photo 18).

**Step-11** If desired, trim the bottom of the driver and passenger side fender liner to match the replacement bumper. Remember to check and retighten the factory and supplied nuts and bolts periodically.



If your state law requires a front license plate, attach the license plate bracket to the holes in the face of the bumper shell, using the supplied 3/8" bolts, washers and nuts, and the license plate to the (2) obround holes in the license plate bracket using the supplied 1/4" bolts and nuts, (Photo 19).

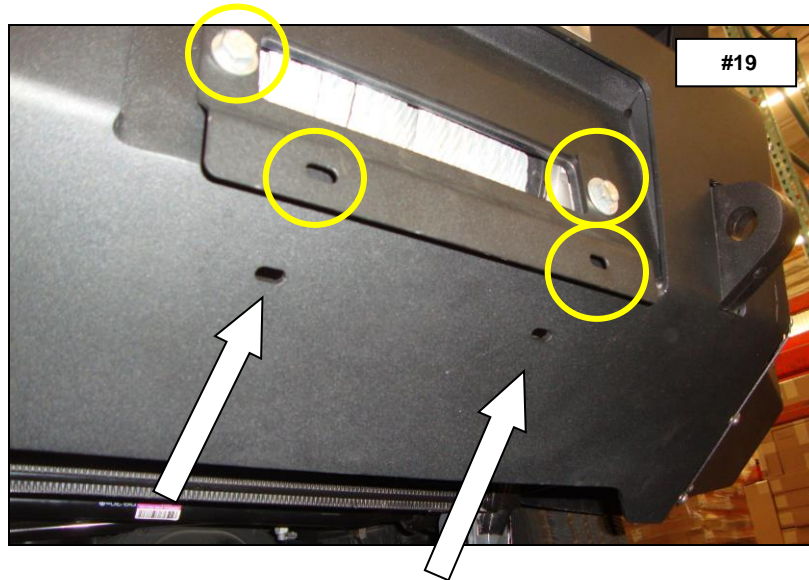

If installing a winch, attach the license plate directly to the (2) obround holes in the lower face of the bumper shell using the supplied 1/4" bolts and nuts, (Photo 18).

Remember to check and retighten all factory and supplied nuts and bolts periodically.