

ENRICO MARONE CINZANO

FURNITURE

MAINTENANCE INSTRUCTIONS

# UPLIGHT 5

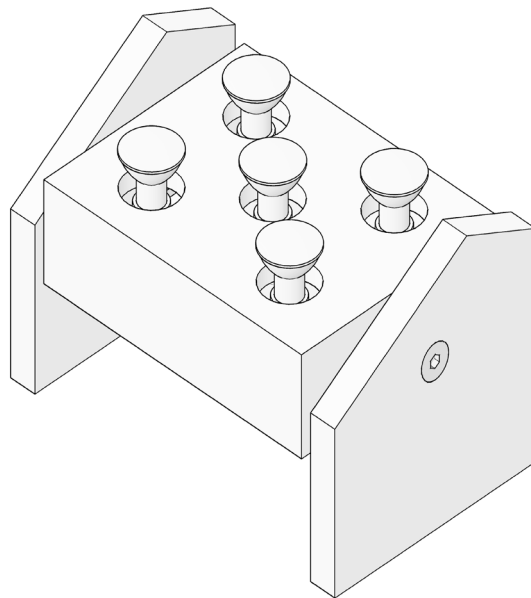
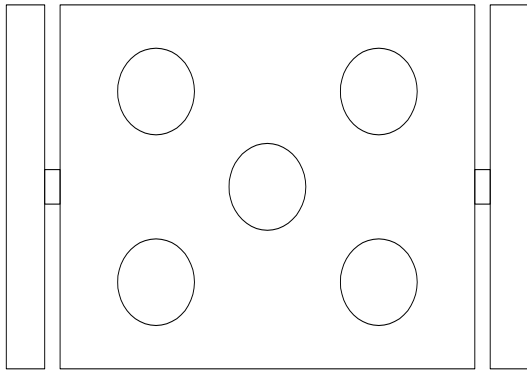
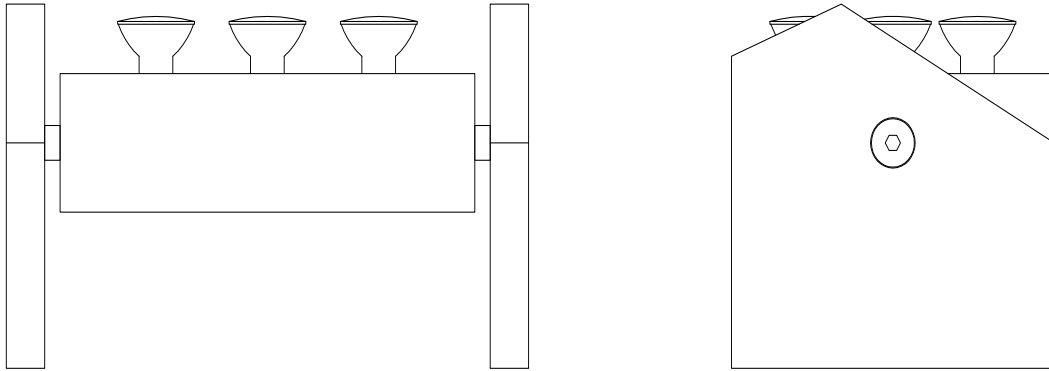

# UPLIGHT 5

## MAINTENANCE INSTRUCTIONS

### WOOD SURFACES:

DUST WITH A SOFT AND COMPLETELY DRIED CLOTH.  
FOR A BETTER AND LONG-LASTING PROTECTION EVERY 6  
MONTHS TREAT THE WOOD WITH LINSEED OIL.

### GLASS SURFACES:

CLEAN THE GLASS WITH A WET CLOTH, USING ONLY NEU-  
TRAL DETERGENTS.