

Deamco Container
Elevator/Lowerator
CESG/CLSG Series

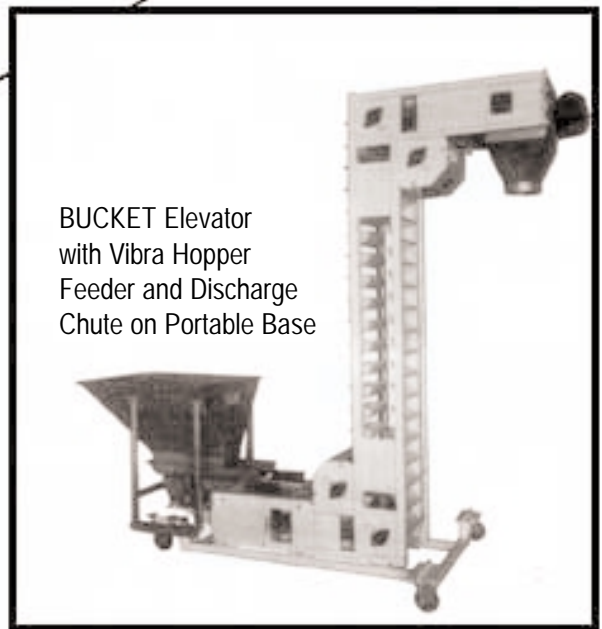

BUCKET Elevator
with Vibra Hopper
Feeder and Discharge
Chute on Portable Base

CONVEYORS



- BELT •VIBRATORY •TABLE TOP •MESH
- BUCKET ELEVATOR/LOWERATOR
- CONTAINER ELEVATOR/LOWERATOR •CUSTOMIZED

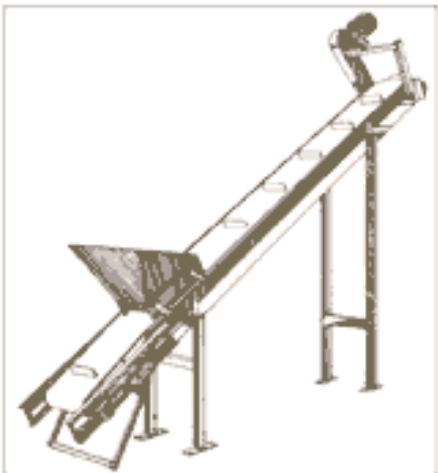
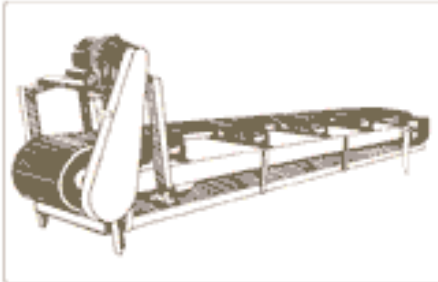
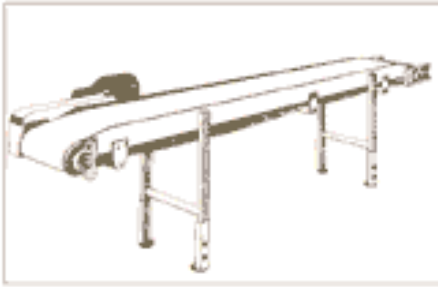

- **Modern streamlined frame**
- **Sanitary constructions**
- **One piece formed channels**
- **Quick coupling sections**
- **Latest design in motor and drive**

Standards

Customized

Systems

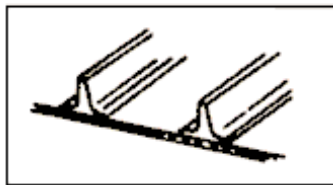
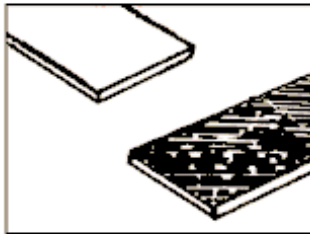
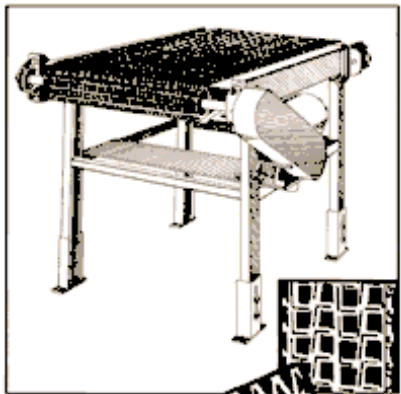
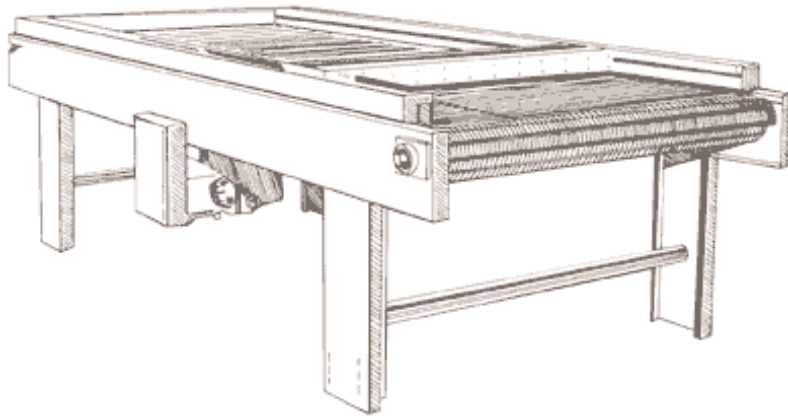

To move a variety of products or product sizes efficiently and economically. Contact APSCO for your conveying needs.

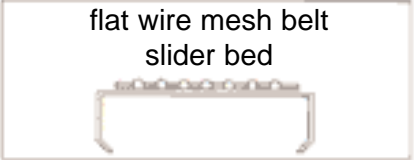
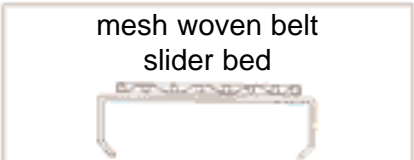
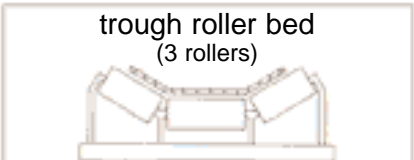
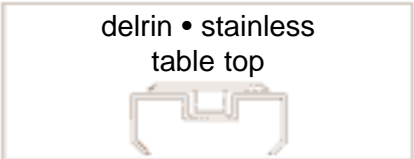
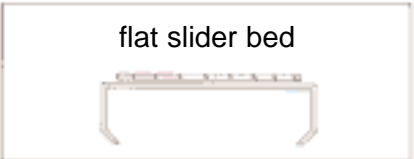
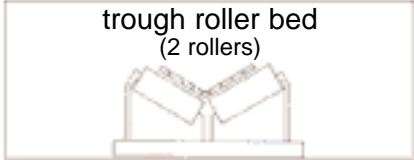
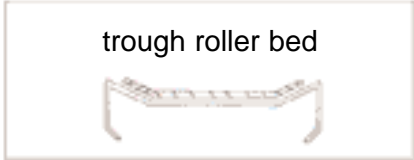
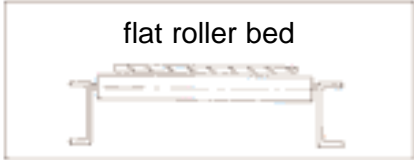
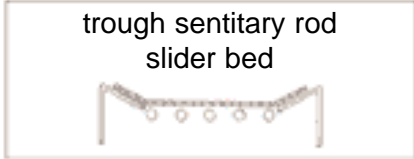

**Deamco Table Top
Conveyors incorporate
the most recent im-
provements in design
and materials and are
ideal for conveying,
accumulating, and
indexing of containers.**

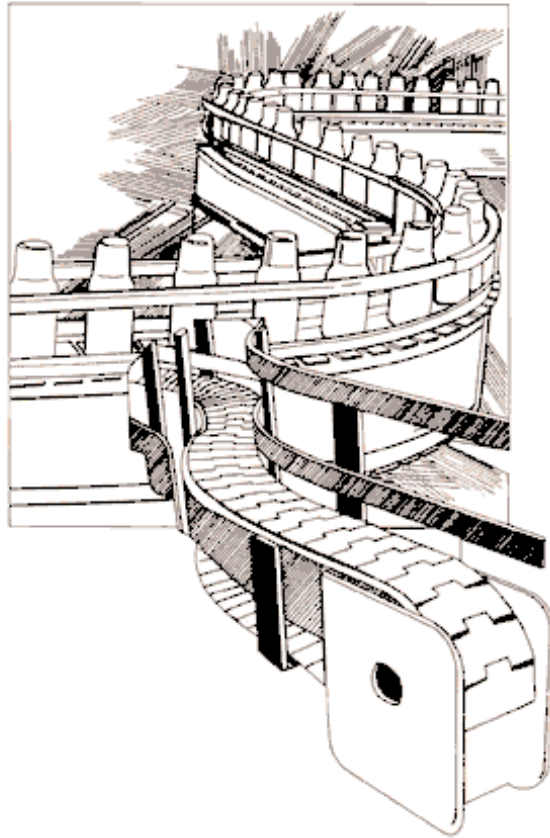
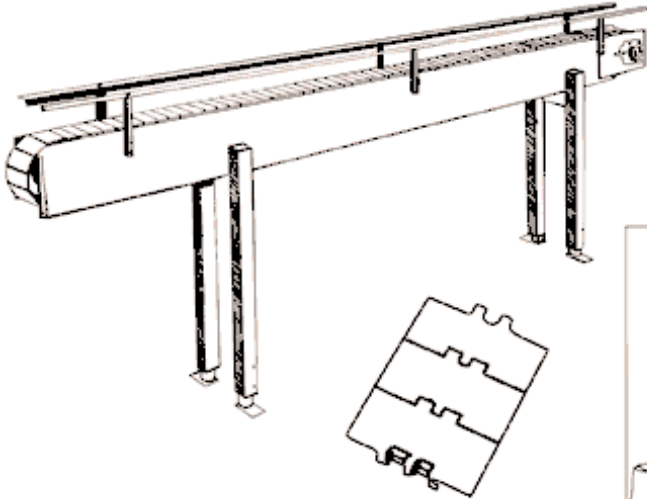

Models for:

- Cans
- Cartons
- Boxes
- Cases
- Jars
- Bottles
- Parts
- Others

Deamco Corp. Is Represented By:
Air Process Systems & Conveyors Co., Inc.®

774 Burr Oak Drive

Westmont, Illinois 60559

Tel: 630.887.0700 800.822.0771

Fax: 630.887.0771

Web: www.AirProcessSystems.com

E-mail: Sales@AirProcessSystems.com

