

CONTENT (MLCC)

E STANDARD NUMBER..... 3

STRUCTURE 4

ORDERING CODE 4

SUPER SMALL SIZE (EIA 01005) 5

 TEST SPEC. 7

PACKAGE 9

OTHERS 13

E Standard Number

E3	1.0								2.2								4.7							
E6	1.0				1.5				2.2				3.3				4.7				6.8			
E12	1.0	1.2	1.5	1.8	2.2	2.7	3.3	3.9	4.7	5.6	6.8	8.2												
E24	1.0	1.1	1.2	1.3	1.5	1.6	1.8	2.0	2.2	2.4	2.7	3.0	3.3	3.6	3.9	4.3	4.7	5.1	5.6	6.2	6.8	7.5	8.2	9.1

MLCC

Structure

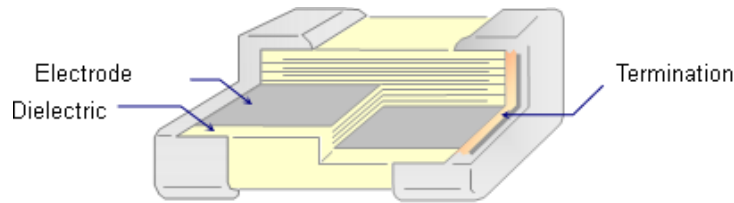

Ordering Code

C 1005 NP0 101 J G T S Δ

PRODUCT CODE

C = MLCC

SIZE in mm (EIA CODE, in inch)

0402(01005)	0603(0201)	1005 (0402)	1608 (0603)	2012 (0805)
3216 (1206)	3225(1210)	4520 (1808)	4532 (1812)	

T. C.

NP0: $0 \pm 30\text{ppm}/^\circ\text{C}$	-55°C to +125°C		
X7R: $\pm 15\%$	-55°C to +125°C	X6S: $\pm 22\%$	-55°C to +105°C
X5R: $\pm 15\%$	-55°C to +85°C	Y5V: $+22\%/-82\%$	-30°C to +85°C

CAPACITANCE CODE

Expressed in pico-farads and identified by a three-digit number.
 First two digits represent significant figures.
 Last digit specifies the number of zeros.
 (Use 9 for 1.0 through 9.9pF ; Use 8 for 0.20 through 0.99pF)

Examples:

Code	Cap (pF)
478	0.47
229	2.2
101	100
102	1000

TOLERANCE CODE

A: $\pm 0.05\text{pF}$	B: $\pm 0.1\text{pF}$	C: $\pm 0.25\text{pF}$	D: $\pm 0.5\text{pF}$	F: $\pm 1\%$	G: $\pm 2\%$
J: $\pm 5\%$	K: $\pm 10\%$	M: $\pm 20\%$	Z: $+80\%/-20\%$		

VOLTAGE CODE

B: 4V	C: 6.3V	D: 10V	E: 16V	F: 25V	N: 35V	G: 50V	H: 100V
J: 200V	K: 250V	L: 500V	M: 630V	P: 1KV	Q: 2KV	R: 3KV	S: 4KV

PACKAGING CODE

T: Paper tape reel Ø180mm (7")	P: Embossed tape reel Ø180mm (7")
N: Paper tape reel Ø250mm (10")	D: Embossed tape reel Ø250mm (10")
A: Paper tape reel Ø330mm (13")	E: Embossed tape reel Ø330mm (13")
W: Special Packing	

Application Code

S: Standard Q: High Q/Low ESR F: Microwave A: Automotive with AEC-Q200

Thickness Code

Code	Thick (mm)	Code	Thick(mm)	Code	Thick (mm)
(blank)	Standard Thick	M	0.70	H	1.50
Z	0.20	D	0.80	L	1.60
A	0.30	E	0.85	N	2.00
Q	0.45	I	0.95	P	2.50
B	0.50	F	1.15	R	3.20
C	0.60	G	1.25		

Super Small Size (EIA 01005)

■ **Feature**

1. Small chip size (LxWxT: 0.4x0.2x0.2mm)
2. No polarity
3. Suited to only reflow soldering
4. RoHS compliant

■ **Application**

1. Microwave module
2. Potable equipment

■ **Standard External Dimensions**

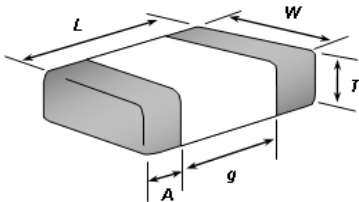

TYPE (EIA Size)	Dimension (mm)				
	L (Length)	W (Width)	T (Max.)	g (Min)	A (Min/Max)
C0402 (01005)	0.4±0.02	0.2±0.02	0.22	0.13	0.07/0.14

■ **Part Number & Characteristic**

● **C0402NP0_S Series (EIA01005)**

RV	DARFON P/N	Measuring Condition	Capacitance		Available Tolerance	Thick. (mm)	Tolerance(mm)		DF (max.)	Standard Packing	Test Spec.
			Value	Unit			L/W	Thick.			
16V	C0402NP0508 ETS	1Vrms, 1MHz	0.5	pF	±0.1pF	0.20	±0.02	±0.02	0.24%	Paper, 20kpcs (W8P2)	(I)
	C0402NP0608 ETS	1Vrms, 1MHz	0.6	pF	±0.1pF	0.20	±0.02	±0.02	0.24%		(I)
	C0402NP0708 ETS	1Vrms, 1MHz	0.7	pF	±0.1pF	0.20	±0.02	±0.02	0.24%		(I)
	C0402NP0808 ETS	1Vrms, 1MHz	0.8	pF	±0.1pF	0.20	±0.02	±0.02	0.24%		(I)
	C0402NP0908 ETS	1Vrms, 1MHz	0.9	pF	±0.1pF	0.20	±0.02	±0.02	0.24%		(I)
	C0402NP0109 ETS	1Vrms, 1MHz	1.0	pF	±0.25pF,±0.1pF	0.20	±0.02	±0.02	0.24%		(I)
	C0402NP0119 ETS	1Vrms, 1MHz	1.1	pF	±0.25pF,±0.1pF	0.20	±0.02	±0.02	0.24%		(I)
	C0402NP0129 ETS	1Vrms, 1MHz	1.2	pF	±0.25pF,±0.1pF	0.20	±0.02	±0.02	0.24%		(I)
	C0402NP0139 ETS	1Vrms, 1MHz	1.3	pF	±0.25pF,±0.1pF	0.20	±0.02	±0.02	0.23%		(I)
	C0402NP0159 ETS	1Vrms, 1MHz	1.5	pF	±0.25pF,±0.1pF	0.20	±0.02	±0.02	0.23%		(I)
	C0402NP0169 ETS	1Vrms, 1MHz	1.6	pF	±0.25pF,±0.1pF	0.20	±0.02	±0.02	0.23%		(I)
	C0402NP0189 ETS	1Vrms, 1MHz	1.8	pF	±0.25pF,±0.1pF	0.20	±0.02	±0.02	0.23%		(I)
	C0402NP0209 ETS	1Vrms, 1MHz	2.0	pF	±0.25pF,±0.1pF	0.20	±0.02	±0.02	0.23%		(I)
	C0402NP0229 ETS	1Vrms, 1MHz	2.2	pF	±0.25pF,±0.1pF	0.20	±0.02	±0.02	0.23%		(I)
	C0402NP0249 ETS	1Vrms, 1MHz	2.4	pF	±0.25pF,±0.1pF	0.20	±0.02	±0.02	0.22%		(I)
	C0402NP0259 ETS	1Vrms, 1MHz	2.5	pF	±0.25pF,±0.1pF	0.20	±0.02	±0.02	0.22%		(I)
	C0402NP0279 ETS	1Vrms, 1MHz	2.7	pF	±0.25pF,±0.1pF	0.20	±0.02	±0.02	0.22%		(I)
	C0402NP0309 ETS	1Vrms, 1MHz	3.0	pF	±0.25pF,±0.1pF	0.20	±0.02	±0.02	0.22%		(I)
	C0402NP0339 ETS	1Vrms, 1MHz	3.3	pF	±0.25pF,±0.1pF	0.20	±0.02	±0.02	0.21%		(I)
	C0402NP0369 ETS	1Vrms, 1MHz	3.6	pF	±0.25pF,±0.1pF	0.20	±0.02	±0.02	0.21%		(I)
	C0402NP0399 ETS	1Vrms, 1MHz	3.9	pF	±0.25pF,±0.1pF	0.20	±0.02	±0.02	0.21%		(I)
	C0402NP0479 ETS	1Vrms, 1MHz	4.7	pF	±0.25pF,±0.1pF	0.20	±0.02	±0.02	0.20%		(I)
	C0402NP0569 ETS	1Vrms, 1MHz	5.6	pF	±0.5pF, ±0.25pF	0.20	±0.02	±0.02	0.20%		(I)
	C0402NP0609 ETS	1Vrms, 1MHz	6.0	pF	±0.5pF, ±0.25pF,±0.1pF	0.20	±0.02	±0.02	0.19%		(I)
	C0402NP0629 ETS	1Vrms, 1MHz	6.2	pF	±0.5pF, ±0.25pF	0.20	±0.02	±0.02	0.19%		(I)
	C0402NP0689 ETS	1Vrms, 1MHz	6.8	pF	±0.5pF, ±0.25pF	0.20	±0.02	±0.02	0.19%		(I)
	C0402NP0709 ETS	1Vrms, 1MHz	7.0	pF	±0.5pF, ±0.25pF	0.20	±0.02	±0.02	0.19%		(I)
	C0402NP0759 ETS	1Vrms, 1MHz	7.5	pF	±0.5pF, ±0.25pF	0.20	±0.02	±0.02	0.18%		(I)
	C0402NP0829 ETS	1Vrms, 1MHz	8.2	pF	±0.5pF, ±0.25pF	0.20	±0.02	±0.02	0.18%		(I)
	C0402NP0919 ETS	1Vrms, 1MHz	9.1	pF	±0.5pF, ±0.25pF	0.20	±0.02	±0.02	0.17%		(I)
C0402NP0100 ETS	1Vrms, 1MHz	10	pF	±5%	0.20	±0.02	±0.02	0.17%	(I)		
C0402NP0180JETS	1Vrms, 1MHz	18	pF	±5%	0.20	±0.02	±0.02	0.13%	(I)		
C0402NP0220JETS	1Vrms, 1MHz	22	pF	±5%	0.20	±0.02	±0.02	0.12%	(I)		
C0402NP0270JETS	1Vrms, 1MHz	27	pF	±5%	0.20	±0.02	±0.02	0.11%	(I)		
C0402NP0470JETS	1Vrms, 1MHz	47	pF	±5%	0.20	±0.02	±0.02	0.10%	(I)		
C0402NP0560JETS	1Vrms, 1MHz	56	pF	±5%	0.20	±0.02	±0.02	0.10%	(I)		
C0402NP0101JETS	1Vrms, 1MHz	100	pF	±5%	0.20	±0.02	±0.02	0.10%	(I)		

MLCC Super Small Size

● C0402X7R_S Series (EIA01005)

RV	DARFON P/N	Measuring Condition	Capacitance		Available Tolerance	Thick. (mm)	Tolerance(mm)		DF (max.)	Standard Packing	Test Spec.
			Value	Unit			L/W	Thick.			
10V	C0402X7R101□DTS	1Vrms, 1kHz	100	pF	±10%	0.20	±0.02	±0.02	5.00%	Paper, 20kpcs (W8P2)	(I)
	C0402X7R121□DTS	1Vrms, 1kHz	120	pF	±10%	0.20	±0.02	±0.02	5.00%		(I)
	C0402X7R151□DTS	1Vrms, 1kHz	150	pF	±10%	0.20	±0.02	±0.02	5.00%		(I)
	C0402X7R181□DTS	1Vrms, 1kHz	180	pF	±10%	0.20	±0.02	±0.02	5.00%		(I)
	C0402X7R221□DTS	1Vrms, 1kHz	220	pF	±10%	0.20	±0.02	±0.02	5.00%		(I)
	C0402X7R271□DTS	1Vrms, 1kHz	270	pF	±10%	0.20	±0.02	±0.02	5.00%		(I)
	C0402X7R331□DTS	1Vrms, 1kHz	330	pF	±10%	0.20	±0.02	±0.02	5.00%		(I)
	C0402X7R391□DTS	1Vrms, 1kHz	390	pF	±10%	0.20	±0.02	±0.02	5.00%		(I)
	C0402X7R471□DTS	1Vrms, 1kHz	470	pF	±10%	0.20	±0.02	±0.02	5.00%		(I)
	C0402X7R561□DTS	1Vrms, 1kHz	560	pF	±10%	0.20	±0.02	±0.02	5.00%		(I)
	C0402X7R681□DTS	1Vrms, 1kHz	680	pF	±10%	0.20	±0.02	±0.02	5.00%		(I)
C0402X7R821□DTS	1Vrms, 1kHz	820	pF	±10%	0.20	±0.02	±0.02	5.00%	(I)		
C0402X7R102□DTS	1Vrms, 1kHz	1	nF	±10%	0.20	±0.02	±0.02	5.00%	(I)		

● C0402X5R_S Series (EIA01005)

RV	DARFON P/N	Measuring Condition	Capacitance		Available Tolerance	Thick. (mm)	Tolerance(mm)		DF (max.)	Standard Packing	Test Spec.
			Value	Unit			L/W	Thick.			
10V	C0402X5R332□DTS	1Vrms, 1kHz	3.3	nF	±10%	0.20	±0.02	±0.02	10.00%	Paper, 20kpcs (W8P2)	(I)
	C0402X5R392□DTS	1Vrms, 1kHz	3.9	nF	±10%	0.20	±0.02	±0.02	10.00%		(II)
	C0402X5R472□DTS	1Vrms, 1kHz	4.7	nF	±10%	0.20	±0.02	±0.02	10.00%		(II)
	C0402X5R562□DTS	1Vrms, 1kHz	5.6	nF	±10%	0.20	±0.02	±0.02	10.00%		(II)
	C0402X5R682□DTS	1Vrms, 1kHz	6.8	nF	±10%	0.20	±0.02	±0.02	10.00%		(II)
	C0402X5R822□DTS	1Vrms, 1kHz	8.2	nF	±10%	0.20	±0.02	±0.02	10.00%		(II)
6.3V	C0402X5R103□DTS	1Vrms, 1kHz	10	nF	±10%	0.20	±0.02	±0.02	10.00%	Paper, 20kpcs (W8P2)	(II)
	C0402X5R332□CTS	1Vrms, 1kHz	3.3	nF	±10%	0.20	±0.02	±0.02	10.00%		(I)
	C0402X5R392□CTS	1Vrms, 1kHz	3.9	nF	±10%	0.20	±0.02	±0.02	10.00%		(II)
	C0402X5R472□CTS	1Vrms, 1kHz	4.7	nF	±10%	0.20	±0.02	±0.02	10.00%		(II)
	C0402X5R562□CTS	1Vrms, 1kHz	5.6	nF	±10%	0.20	±0.02	±0.02	10.00%		(II)
	C0402X5R682□CTS	1Vrms, 1kHz	6.8	nF	±10%	0.20	±0.02	±0.02	10.00%		(II)
	C0402X5R822□CTS	1Vrms, 1kHz	8.2	nF	±10%	0.20	±0.02	±0.02	10.00%		(II)
	C0402X5R103□CTS	1Vrms, 1kHz	10	nF	±10%	0.20	±0.02	±0.02	10.00%		(II)
C0402X5R104□CTS	1Vrms, 1kHz	100	nF	±20%	0.20	±0.02	±0.02	10.00%	(II)*		

□Tolerance Code: A=±0.05 pF, B=±0.1pF, C=±0.25pF ,D=±0.5pF, F=±1%, G=±2%, J=±5%, M=±20%; Special tolerance on the request.

(II)* High temperature load life test are applicable in rated voltage *100%

● Test Spec.

Item	Specification		Test Method
	Class I (NP0)	Class II (X5R/X7R)	
1	Operating Temperature Range		Standard Temperature: 25°C
2	Rated Voltage		The rated voltage is defined as the maximum voltage, which may be applied continuously to the capacitor.
3	Appearance		Visual inspection with Microscope.
4	Dimensions		Using calipers or Microscope.
5	Dielectric Strength		No failure shall be observed when 250% of the rated voltage is applied between the terminations for 1 to 5 seconds. The charge and discharge current is less than 50mA.
6	Insulation Resistance (I.R.)		The insulation resistance shall be measured with a DC voltage not exceeding the rated voltage at 25°C and 75%RH max, and within 1 minute of charging.
7	Capacitance		The capacitance / D.F. shall be measured at 25°C at the frequency and voltage shown in the table of "Part Number & Characteristic".
8	Q/Dissipation Factor (D.F.)		
9	Capacitance Temperature Characteristics		
10	Termination Strength		
11	Deflection (Bending Strength)		
12	Solderability of Termination		
13	Temperature cycle (Thermal shock)	Appearance	
		Cap. Change	
		Q/D.F.	
		I.R.	

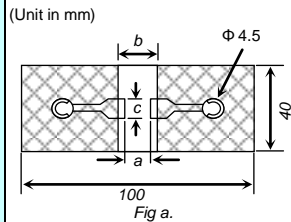

Size	a	b	c
0402	0.2	0.56	0.23

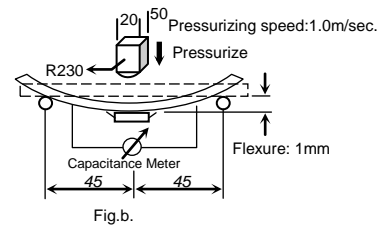

	Item	Specification		Test Method	
		Class I (NP0)	Class II (X5R/X7R)		
14	Humidity load	Appearance	No marking defects		Apply the rated voltage at 40±2°C and 90 to 95% humidity for 500±12 hours. Remove and let sit for 24±2 hours at room temperature, then measure. The charge / discharge current is less than 50mA. *Class II: Initial measurement: perform a heat treatment at 150±10°C for one hour and then let sit for 24±2 hours at room temperature. Perform the initial measurement.
		Cap. Change	NP0 within ±7.5% or 0.75pF (whichever is larger)	X7R/X5R within ±12.5%	
		Q/D.F.	If C > 30pF, DF ≤ 0.5% If C ≤ 30pF, DF ≤ 1/(100+10xC/3) C in pF	X7R/X5R 200% max of initial spec.	
		I.R.	I.R. ≥ 500MΩ or R _C R _r ≥ 25Ω-F. (whichever is smaller)	I.R. ≥ 500MΩ or R _C R _r ≥ 25Ω-F. (whichever is smaller) * Some of the parts are R _C R _r ≥ 12.5. Please refer to table 1.	
15	High temperature load life test	Appearance	No marking defects		Apply 200% of the rated voltage for 1,000±12 hours at the maximum operating temperature ± 3°C. Let sit for 24± 2 hours at room temperature, then measure. The charge/discharge current is less than 50mA. *High dielectric constant type: Initial measurement: perform a heat treatment at 150±10°C for one hour and then let sit for 24±2 hours at room temperature. Perform the initial measurement. * Some of the parts are applicable in different voltage. Please refer to table 1.
		Cap. Change	NP0 within ±7.5% or 0.75pF (whichever is larger)	X7R/X5R within ±12.5%	
		Q/D.F.	If C > 30pF, DF ≤ 0.3% If 10pF < C ≤ 30pF, DF ≤ 1/(275+5xC/2) If C ≤ 10pF, DF ≤ 1/(200+10C), C in pF	X7R/X5R 200% max of initial value	
		I.R.	More than 1GΩ or R _C R _r ≥ 50 Ω-F (whichever is less.)	More than 1GΩ or R _C R _r ≥ 50 Ω-F (whichever is less.) * Some of the parts are R _C R _r ≥ 25Ω-F. Please refer to table 1.	

Table 1

Part Number	Durability (% Rated Voltage)	Cap Value	RV
C0402X5R392□DTS	150%	3.9 nF	10V
C0402X5R472□DTS	150%	4.7 nF	10V
C0402X5R682□DTS	150%	6.8 nF	10V
C0402X5R103□DTS	150%	10 nF	10V
C0402X5R104□CTS	100%	100 nF	6.3V

Package

- Tape and reel packaging**

Tape and reel packaging is currently the most promising system for high-speed production. A typical 180mm (7 inch) diameter reel contains 1,500 to 15,000 capacitors, 250mm (10 inch) contains 10,000 capacitors, and 330mm (13 inch) contains 10,000 to 50,000 capacitors. Three standard sizes are available in taped and reeled package either with paper carrier tapes or embossed tapes.

【Paper tape specifications】

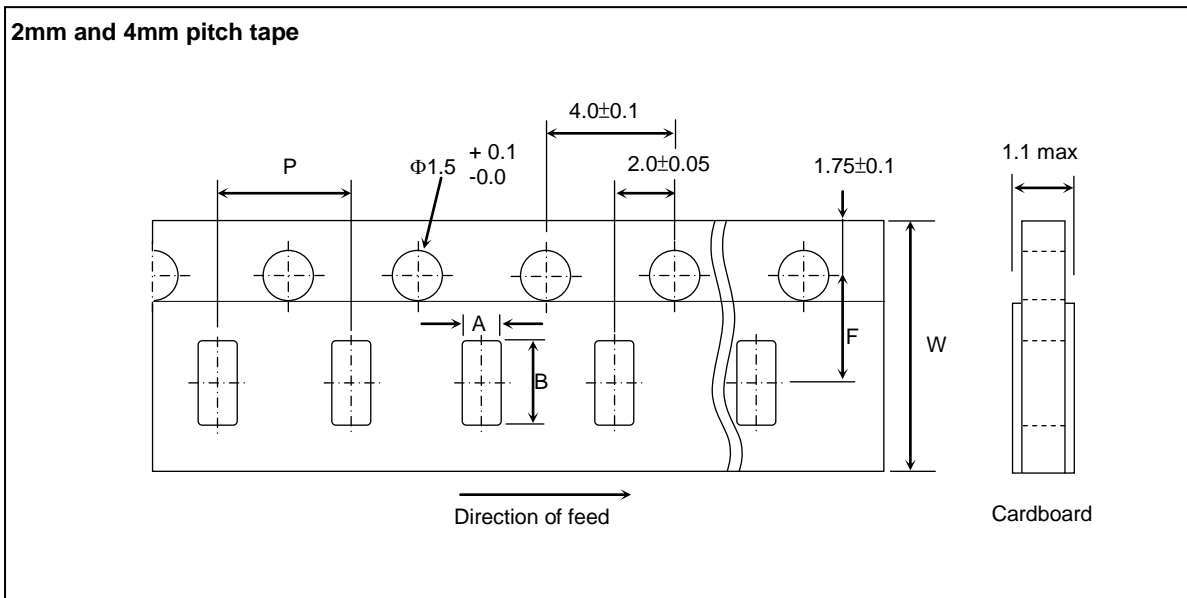

SYMBOL	PRODUCT SIZE CODE												UNIT
	0402(01005)		0603(0201)		1005(0402) (±0.05 mm)		1005(0402) (±0.10 mm)		1005(0402) (±0.15 mm)		1005(0402) (±0.20 mm)		
	SIZE	TOL.	SIZE	TOL.	SIZE	TOL.	SIZE	TOL.	SIZE	TOL.	SIZE	TOL.	
A	0.23	±0.02	0.38	±0.04	0.65	±0.10	0.70	±0.10	0.72	±0.10	0.80	±0.10	mm
B	0.43	±0.02	0.68	±0.04	1.15	±0.10	1.19	±0.10	1.25	±0.10	1.35	±0.10	mm
F	3.5	±0.05	3.5	±0.05	3.5	±0.05	3.5	±0.05	3.5	±0.05	3.5	±0.05	mm
P	2	±0.05	2	±0.10	2	±0.10	2	±0.10	2	±0.10	2	±0.10	mm
W	8	±0.20	8	±0.20	8	±0.20	8	±0.20	8	±0.20	8	±0.20	mm

SYMBOL	PRODUCT SIZE CODE (EIA)								UNIT
	1608 (0603) (±0.15 mm)		1608 (0603) (±0.20 mm)		2012 (0805)		3216 (1206)		
	Size	Tol.	Size	Tol.	Size	Tol.	Size	Tol.	
A	1.0	±0.2	1.1	±0.2	1.5	±0.2	1.9	±0.2	mm
B	1.8	±0.2	1.9	±0.2	2.3	±0.2	3.6	±0.2	mm
F	3.5	±0.05	3.5	±0.05	3.5	±0.05	3.5	±0.05	mm
P	4	±0.1	4	±0.1	4	±0.1	4	±0.1	mm
W	8	±0.2	8	±0.2	8	±0.2	8	±0.2	mm

【 Embossed tape specifications 】

1mm and 4mm and 8mm pitch tape

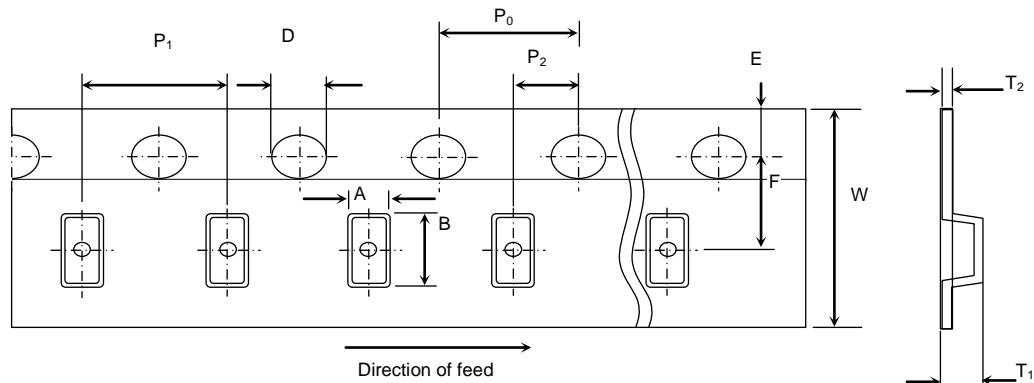

For W= 8mm: T₁=2.5mm max.

For W= 12mm: T₁= 4.5mm

DIMENSION (mm)	PRODUCT SIZE CODE						
	1mm tape	4 mm tape				8 mm tape	
	0402 (01005)	1608 (0603)	2012 (0805)	3216 (1206)	3225 (1210)	4520 (1808)	4532 (1812)
P ₁	1±0.02	4±0.1	4±0.1	4±0.1	4±0.1	8±0.1	8±0.1
P ₀	2±0.04	4±0.1	4±0.1	4±0.1	4±0.1	4±0.1	4±0.1
P ₂	1±0.02	2±0.05	2±0.05	2±0.05	2±0.05	2±0.05	2±0.05
A	0.23±0.02	1.2±0.2	1.45±0.2	1.9±0.2	2.8±0.2	2.3±0.2	3.6±0.2
B	0.43±0.02	2.0±0.2	2.3±0.2	3.5±0.2	3.6±0.2	4.9±0.2	4.9±0.2
W	4±0.05	8±0.3	8±0.2	8±0.2	8±0.2	12±0.2	12±0.2
E	0.9±0.05	1.75±0.1	1.75±0.1	1.75±0.1	1.75±0.1	1.75±0.1	1.75±0.1
F	1.8±0.02	3.5±0.05	3.5±0.05	3.5±0.05	3.5±0.05	5.5±0.05	5.5±0.05
D	0.8±0.04	1.5 (+0.1/-0.0)	1.5 (+0.1/-0.0)	1.5 (+0.1/-0.0)	1.5 (+0.1/-0.0)	1.5 (+0.1/-0.0)	1.5 (+0.1/-0.0)
T ₁	0.5 max	1.4 max.	2.5 max.	2.5 max.	2.5 max.	4.5	4.5
T ₂	0.15~0.40	0.25±0.1	0.305±0.1	0.30±0.1	0.30±0.1	0.30±0.1	0.30±0.1

【Reel specifications】

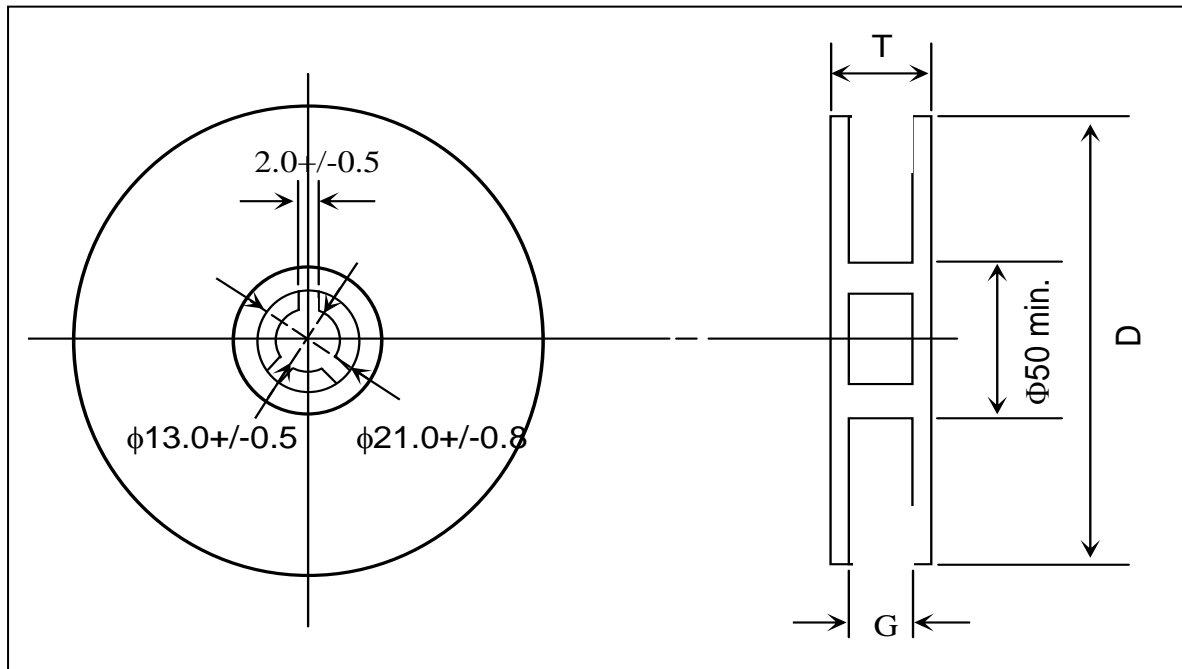

TAPE WIDTH (mm)	G (mm)	T max. (mm)	D (mm)
4	5.0 ± 1.5	8.0	180
8	10.0 ± 1.5	14.5	180
8	10.0 ± 1.5	14.5	250
8	10.0 ± 1.5	14.5	330
12	14.0 ± 1.5	18.5	180

MLCC

【Thickness and Packing Amount】

Thickness			Amount per reel			
			180 mm (7")		330 mm (13")	
Code	Spec.(mm)	Size (EIA)	Paper	Embossed	Paper	Embossed
Z	0.20	0402 (01005)	20K	40K ^{#1}		
A	0.30	0603 (0201)	15K		50K	
		1005 (0402)	15K		50K	
B	0.50	1005 (0402)	10K		50K	
Q	0.45	1005 (0402)	10K		50K	
		1608 (0603)	4K		15K	
C	0.60	2012 (0805)	4K		15K	
		3216 (1206)	4K		15K	
D	0.80	1608 (0603)	4K	4K	15K	
E	0.85	2012 (0805)	4K		15K	
		3216 (1206)	4K		15K	
		3225 (1210)		3K		10K
I	0.95	4532 (1812)		1K		
		2012 (0805)		3K		
F	1.15	3216 (1206)		3K		
		4520 (1808)		3K		10K
H	1.25	3216 (1206)		3K		10K
		2012 (0805)		2K/3K		10K
		3216 (1206)		3K		10K
		3225 (1210)		3K		
		4520 (1808)		2K/3K		
		4532 (1812)		1K		
L	1.60	3225 (1210)		3K		
		3216 (1206)		2K		
		3225 (1210)		2K		
		4520 (1808)		2K		
N	2.00	4532 (1812)		1K		
		3216 (1206)		2K/3K		
		3225 (1210)		2K		
		4520 (1808)		1K		
P	2.50	4532 (1812)		1K		
		3225 (1210)		500pcs/1K		

#1: 4mm width 1mm pitch Embossed Taping

【Packing Rule】

EIA SIZE	Tape	Reel Size	Reels/Box	Boxes/ Carton
01005	Emboss	7"	8	12
01005	Paper	7"	5	12
0201	Paper	7"	5	12
0402	Paper	7"	5	12
0603	Paper/Emboss	7"	5	12
0805	Paper/Emboss	7"	5	12
1206	Paper/Emboss	7"	5	12
1210	Emboss	7"	5	12
1808	Emboss	7"	5	12
1812	Emboss	7"	5	12

Others

【Storage】

1. The chip capacitors shall be packaged in carrier tapes or bulk cases.
2. Keep storage place temperatures from +5°C to +35°C, humidity from 45 to 70% RH.
3. The storage atmosphere must be free of gas containing sulfur and chlorine. Also, avoid exposing the product to saline moisture. If the product is exposed to such atmospheres, the terminations will oxidize and solderability will be affected.
4. The solderability is assured for 12 months from our final inspection date if the above storage condition is followed.

【Circuit Design】

1. Once application and assembly environments have been checked, the capacitor may be used in conformance with the rating and performance, which are provided in both the catalog and the specifications. Exceeding the specifications listed may result in inferior performance. It may also cause a short, open, smoking, or flaming to occur, etc.
2. Please use the capacitors in conformance with the operating temperature provided in both the catalog and the specifications. Be especially cautious not to exceed the maximum temperature. In the situation the maximum temperature set forth in both the catalog and specifications is exceeded, the capacitor's insulation resistance may deteriorate, power may suddenly surge and short-circuit may occur. The loss of capacitance will occur, and may self-heat due to equivalent series resistance when alternating electric current is passed through. As this effect becomes critical in high frequency circuits, please exercise with caution. When using the capacitor in a (self-heating) circuit, please make sure the surface of the capacitor remains under the maximum temperature for usage. Also, please make certain temperature rise remain below 20°C.
3. Please keep voltage under the rated voltage, which is applied to the capacitor. Also, please make certain the peak voltage remains below the rated voltage when AC voltage is super-imposed to the DC voltage. In the situation where AC or pulse voltage is employed, ensure average peak voltage does not exceed the rated voltage. Exceeding the rated voltage provided in both catalog and specifications may lead to defective withstanding voltage or, in worse case situations, may cause the capacitor to burn out.
4. It's is a common phenomenon of high-dielectric products to have a deteriorated amount of static electricity due to the application of DC voltage.

【Handling】

Chip capacitors should be handled with care to avoid contamination or damage. The use of vacuum pick-up or plastic tweezers is recommended for manual placement. Tape and reeled packages are suitable for automatic pick and placement machine.

【Flux】

1. An excessive amount of flux or too rapid temperature rise can cause solvent burst, solder can generate a large quantity of gas. The gas can spread small solder particles to cause solder balling effect or bridging problem.
2. Flux containing too high of a percentage of halide may cause corrosion of termination unless sufficient cleaning is applied.
3. Use rosin-type flux. Highly acidic flux (halide content less than 0.2wt%) is not recommended.
4. The water soluble flux causes deteriorated insulation resistance between outer terminations unless sufficiently cleaned.

【Component Spacing】

For wave soldering components, the spacing must be sufficient far apart to prevent bridging or shadowing. This is not so important for reflow process but enough space for rework should be considered. The suggested spacing for reflow soldering and wave soldering is 0.5mm and 1.0mm, respectively.

【Solder Fillet】

Too much solder amount may increase solder stress and cause crack risk. Insufficient solder amount may reduce adhesive strength and cause parts falling off PCB. When soldering, confirm that the solder is placed over 0.2mm of the surface of the terminations.

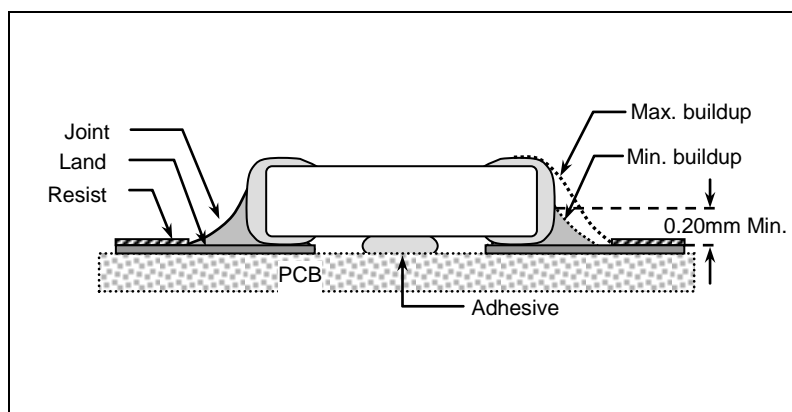

【Recommended Land Pattern Dimensions】

When mounting the capacitor to substrate, it's important to consider that the amount of solder (size of fillet) used has a direct effect upon the capacitor once it's mounted.

1. The greater the amount of solder, the greater the stress to the elements, as this may cause the substrate to break or crack.
2. In the situation where two or more devices are mounted onto a common land, separate the device into exclusive pads by using soldering resist.
3. Land width equal to or less than component. It is permissible to reduce land width to 80% of component width.

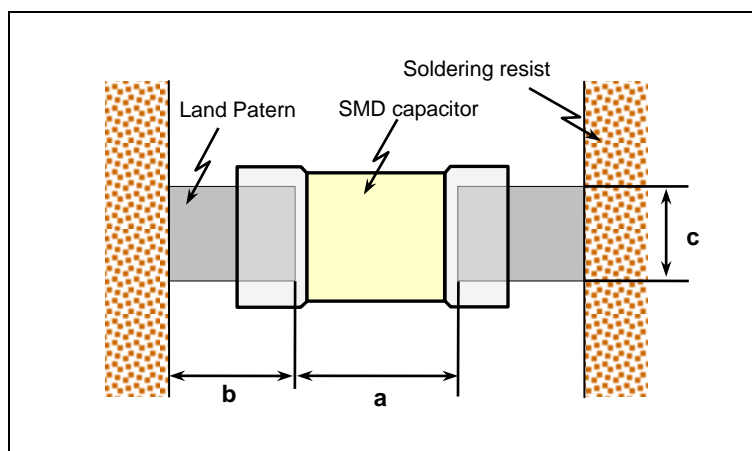

Size mm (EIA)	L x W (mm) (Dimension tolerance)	a (mm)	b (mm)	c (mm)
0402 (01005)	0.4*0.2	0.16 to 0.20	0.12 to 0.18	0.20 to 0.23
0603 (0201)	0.6*0.3	0.15 to 0.35	0.2 to 0.3	0.25 to 0.3
1005 (0402)	1.0*0.5 (within±0.10)	0.3 to 0.5	0.35 to 0.45	0.4 to 0.5
	1.0*0.5 (±0.15 or ±0.20)	0.4 to 0.6	0.4 to 0.5	0.5 to 0.6
1608 (0603)	1.6*0.8 (within±0.10)	0.7 to 1.0	0.6 to 0.8	0.7 to 0.8
	1.6*0.8 (±0.15 or ±0.20)	0.8 to 1.1	0.7 to 0.9	0.8 to 0.9
2012 (0805)	2.0*1.25	1.0 to 1.3	0.7 to 0.9	1.0 to 1.2
3216 (1206)	3.2*1.6	2.1 to 2.5	1.0 to 1.2	1.3 to 1.6
3225 (1210)	3.2*2.5	2.1 to 2.5	1.0 to 1.2	2.0 to 2.5
4520 (1808)	4.5*2.0	3.2 to 3.8	1.2 to 1.4	1.7 to 2.0
4532 (1812)	4.5*3.2	3.2 to 3.8	1.2 to 1.4	2.7 to 3.2

【Resin Mold】

If a large amount of resin is used for molding the chip, cracks may occur due to contraction stress during curing. To avoid such cracks, use a low shrinkage resin. The insulation resistance of the chip will degrade due to moisture absorption. Use a low moisture absorption resin. Check carefully that the resin does not generate a decomposition gas or reaction gas during the curing process or during normal storage. Such gases may crack the chip capacitor or damage the device itself.

【Soldering Profile for SMT Process with SnPb Solder Paste】

Reflow Soldering

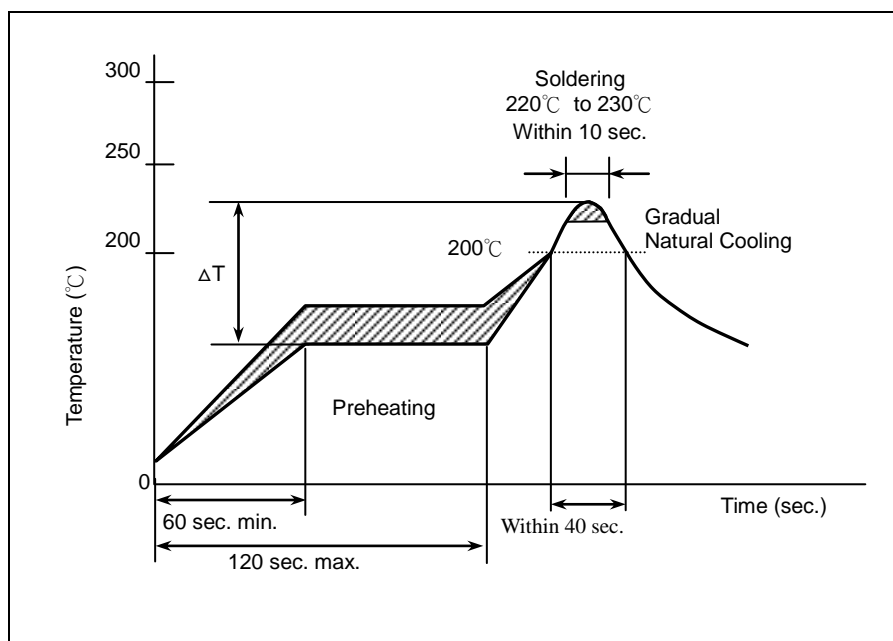

The difference between solder and chip surface should be controlled as following table. The rate of preheat should not exceed 4°C/sec and a target of 2°C/sec is preferred.

Chip Size	3216 and smaller	3225 and above
Preheating	$\Delta T \leq 150^\circ\text{C}$	$\Delta T \leq 130^\circ\text{C}$

Wave Soldering

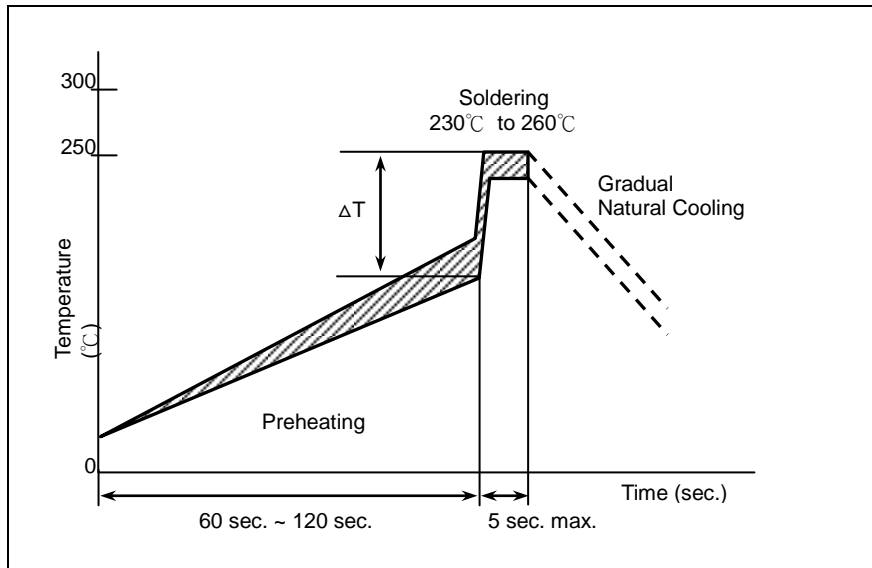

Chip Size	3216 and smaller	3225 and above
Preheating	$\Delta T \leq 150^\circ\text{C}$	-

Soldering Iron

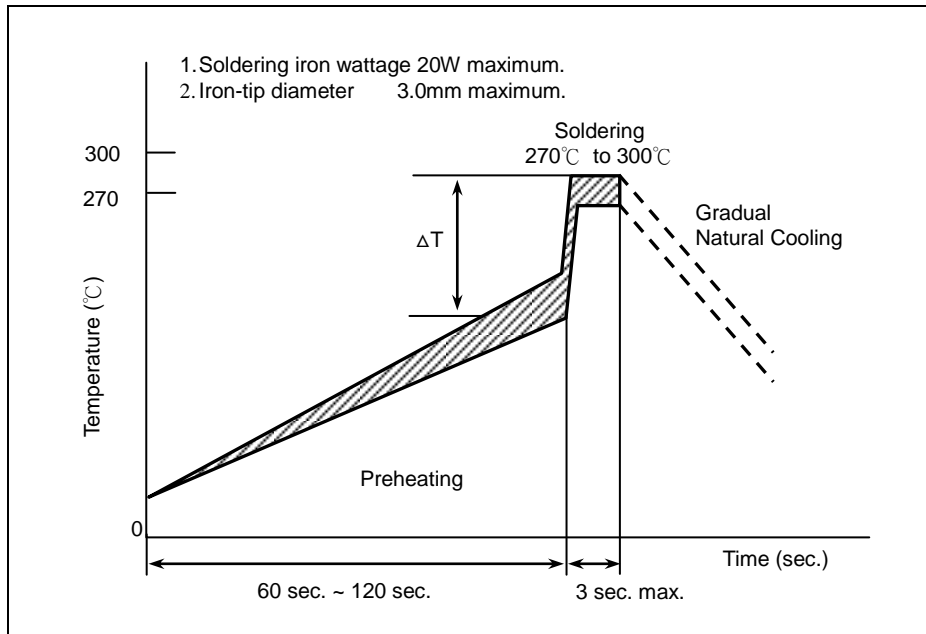

Chip Size	3216 and smaller	3225 and above
Preheating	$\Delta T \leq 190^\circ\text{C}$	$\Delta T \leq 130^\circ\text{C}$

MLCC

[Soldering]

Reflow Soldering for Lead free Termination

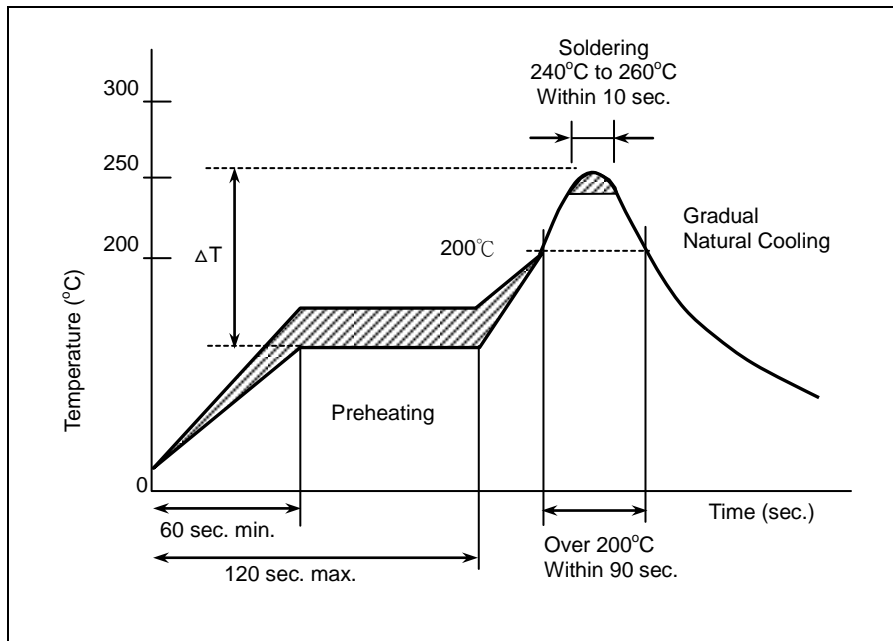

The difference between solder and chip surface should be controlled as following table. The rate of preheat should not exceed 4°C/sec and a target of 2°C/sec is preferred.

Chip Size	3216 and smaller	3225 and above
Preheating	$\Delta T \leq 150^\circ\text{C}$	$\Delta T \leq 130^\circ\text{C}$

Flow Soldering for Lead free Termination

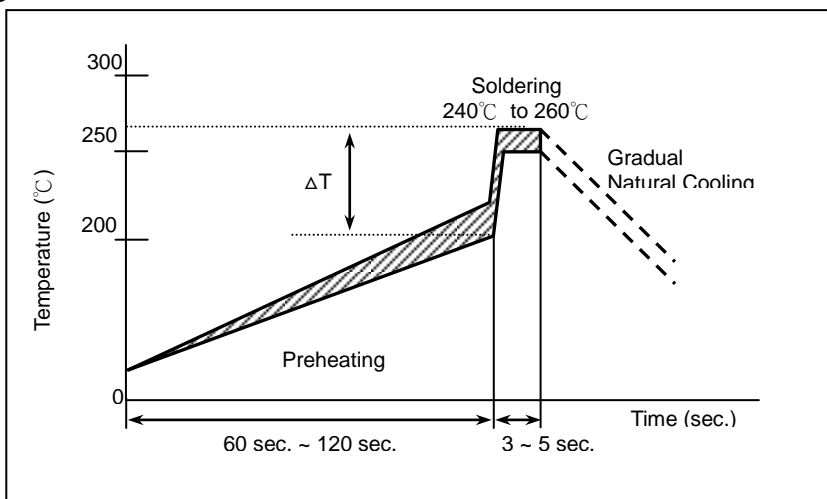

Chip Size	3216 and smaller	3225 and above
Preheating	$\Delta T \leq 150^\circ\text{C}$	-

Soldering Iron

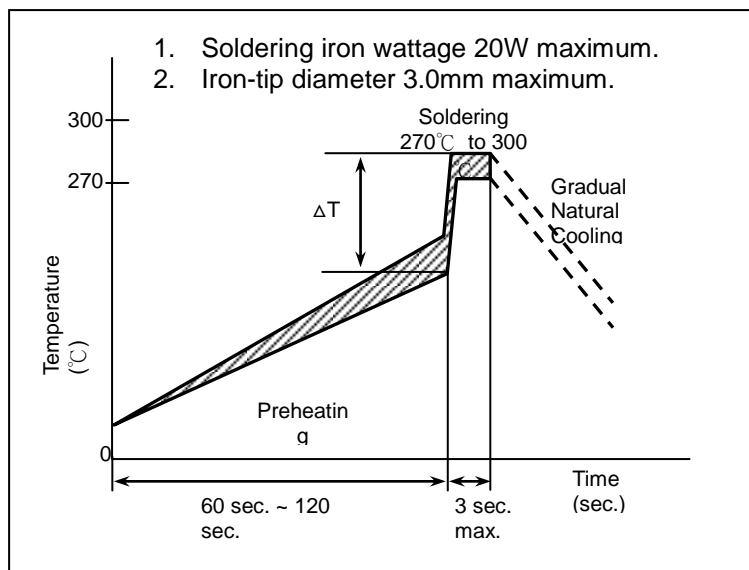

Chip Size	3216 and smaller	3225 and above
Preheating	$\Delta T \leq 190^{\circ}\text{C}$	$\Delta T \leq 130^{\circ}\text{C}$

【Chip Layout and Breaking PCB】

- To layout the SMD capacitors for reducing bend stress from board deflection of PCB. The following are examples of Hood and bad layout.

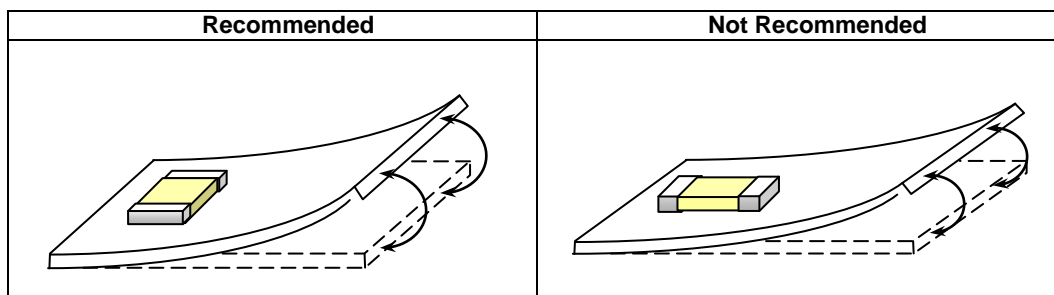

- When breaking PCB, the layout should be noted that the mechanical stresses are depending on the position of capacitors. The following example shows recommendation for better design.

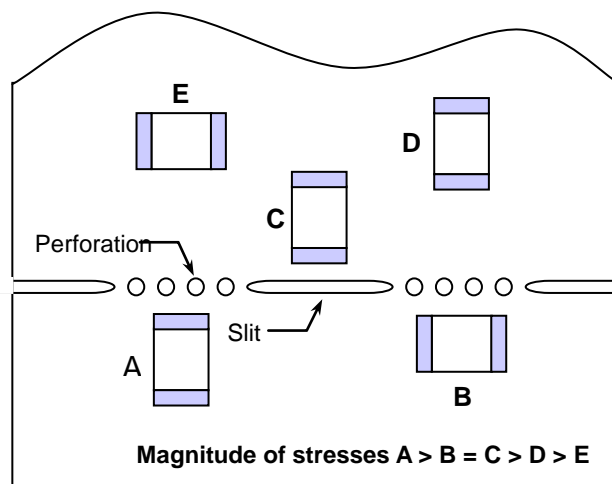

【Aging Rate】

The capacitance and dissipation factor of class 2 capacitors decreases with time. It is known as 'aging' that follows a logarithmic law and expressed in terms of an aging constant. Aging is caused by a gradual re-alignment of the crystalline structure of the ceramic. The aging constant is defined as the percentage loss of capacitance at a 'time decade'. The law of capacitance aging is expressed as following equation:

Typical Curve of Aging Rate of Different Dielectric Material

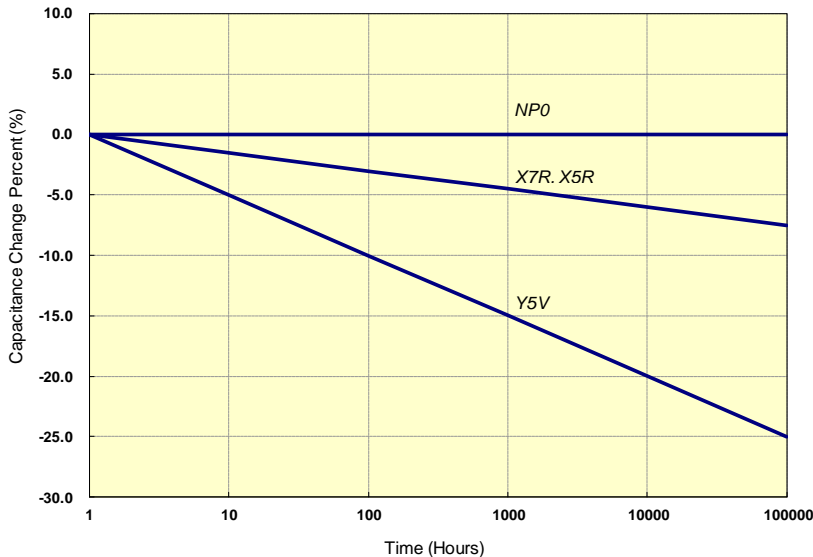

$$C_{t_2} = C_{t_1} \times (1 - k \times \log_{10}(t_2/t_1))$$

C_{t_1} : Capacitance after t_1 hours of start aging.

C_{t_2} : Capacitance after t_2 hours of start aging.

k : aging constant (capacitance decrease per decade)

t_1, t_2 : time in hours from start of aging.

A typical curve of aging rate is shown in following figure.

When heating the capacitors above Curie temperature ($130^{\circ}\text{C} \sim 150^{\circ}\text{C}$) the capacitance can be re-new. So capacitance of class 2 capacitors will be complete de-aged by soldering process; subsequently a new aging process begins.

Because of aging, it is specified an age for measurement to meet the prescribed tolerance for class 2 capacitors. Normally, 1000 hours ($t_2=1000$ hrs) is defined.

【Peeling Off Force】

Peeling off force: 0.1N to 1.0N^* in the direction shown as below.

The peeling speed: 300 ± 10 mm/min

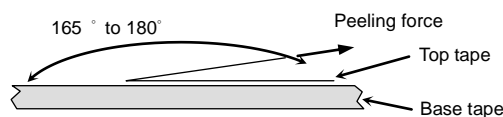

1. The taped tape on reel is wound clockwise. The sprocket holes are to the right as the tape is pulled toward the user.
2. There are minimum 150 mm as the leader and minimum 40 mm empty tape as the tail is attached to the end of the tape.