

ON THE RIGHT TRACK

Lighting track systems and adapters



INTALITE UK

Loving Light!

20
20

CONTENTS

00 INTRODUCTION page 03

01 3-CIRCUIT TRACK SYSTEM page 05

02 3-CIRCUIT DALI TRACK SYSTEM page 11

03 1-CIRCUIT DALI TRACK SYSTEM page 17

04 TRACK SUSPENSION & GENERAL ACCESSORIES page 23

05 ADAPTERS page 29

06 48V TRACK SYSTEM page 33

07 ROBUST SINGLE CIRCUIT TRACK SYSTEM page 39



POWERGEAR[®]

EUROPE



RoHS



Cost effective & High quality standards:

Powergear is a strong global brand in tailor made lighting track systems and universal adapters for the professional lighting market. Powergear offers a high quality 3 circuit (3-phase) lighting track system which is fully compatible with 3-phase adapters of all major brands. The comprehensive range of innovative accessories – like the twisted L and T connectors – gives the designer maximum freedom to create the ultimate track plan. To guarantee cost-effectiveness and flexibility, we make use of our own manufacturing facilities with our products being produced under certified ISO9001 and ISO14001 regulations and ENEC, CE and UL labels which are relevant for the European and/ or US market.

Customer service:

From our European head office for sales, service and distribution we offer swift and efficient deliveries and strive to provide the highest level of customer service possible. The growing Powergear distribution centre network ensures availability throughout all European countries, making Powergear the winning brand in Lighting Track.

Flexible solutions:

Due to our strong customer focus, Powergear is willing and able to offer flexible opportunities to fulfill the specific needs of a customer. From a fully customized product to our standard product and every step in between is part of the Powergear offer and service. This means that Powergear can offer a solution in own package or label of the customer, but also a complete private label concept. In general it means that Powergear is willing to walk the extra mile to satisfy our customer.



01

3-CIRCUIT TRACK SYSTEM

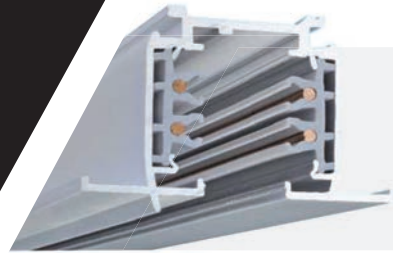

- High quality 3-circuit track system for the professional lighting market.
- Suitable for track lights with 3-phase adapters of all major brands.
- A comprehensive range of innovative accessories, like the twisted L and T connectors.
- Maximum freedom to create the ultimate track plan.
- Quick and easy to install.
- No need to adjust the wires after cutting the track.
- Also available in recessed version.

MECHANICAL LOAD DIAGRAM

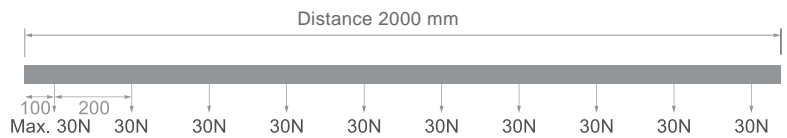
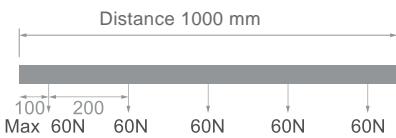

FIXING POINT DIMENSIONS

L / mm	a / mm	b / mm	c / mm	d / mm
1000	125			
2000	125	998		
3000	125		914	1167

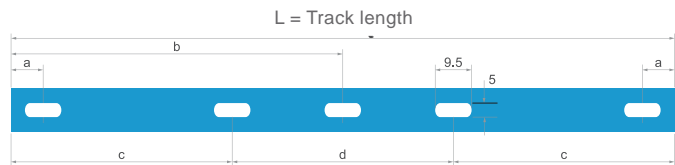

It is recommended to fasten the track at every hole with a screw or suspension kit.

CONNECTING DIAGRAM

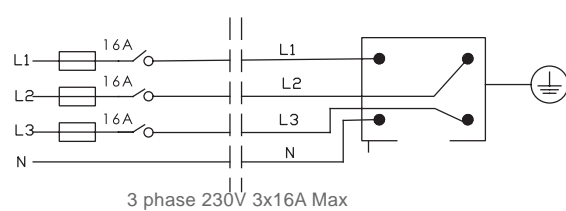
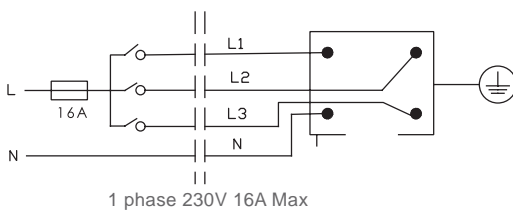

3-CIRCUIT SURFACE MOUNTED TRACK SYSTEM

Product Code	EAN	Product description	Colour	Price
PRO-0410-W	8719747930007	1 M track (1000mm)	White 	£ 24.90
PRO-0410-S	8719747930014	1 M track (1000mm)	Grey 	£ 24.90
PRO-0410-B	8719747930021	1 M track (1000mm)	Black 	£ 24.90
<hr/>				
PRO-0420-W	8719747930069	2 M track (2000mm)	White 	£ 44.90
PRO-0420-S	8719747930076	2 M track (2000mm)	Grey 	£ 44.90
PRO-0420-B	8719747930083	2 M track (2000mm)	Black 	£ 44.90
<hr/>				
PRO-0430-W	8719747930120	3 M track (3000mm)	White 	£ 69.90
PRO-0430-S	8719747930137	3 M track (3000mm)	Grey 	£ 69.90
PRO-0430-B	8719747930144	3 M track (3000mm)	Black 	£ 69.90

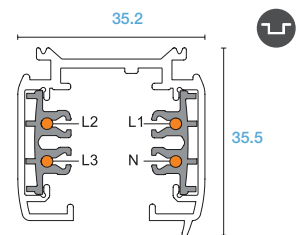

3-CIRCUIT RECESSED TRACK SYSTEM

Product Code	EAN	Product description	Colour	Package
PRO-R410-W	8719747931011	1 M track (1000mm)	White 	£ 29.90
PRO-R410-S	8719747931028	1 M track (1000mm)	Grey 	£ 29.90
PRO-R410-B	8719747931035	1 M track (1000mm)	Black 	£ 29.90
<hr/>				
PRO-R420-W	8719747931042	2 M track (2000mm)	White 	£ 49.90
PRO-R420-S	8719747931059	2 M track (2000mm)	Grey 	£ 49.90
PRO-R420-B	8719747931066	2 M track (2000mm)	Black 	£ 49.90
<hr/>				
PRO-R430-W	8719747931073	3 M track (3000mm)	White 	£ 79.90
PRO-R430-S	8719747931080	3 M track (3000mm)	Grey 	£ 79.90
PRO-R430-B	8719747931097	3 M track (3000mm)	Black 	£ 79.90

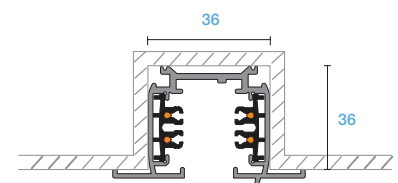
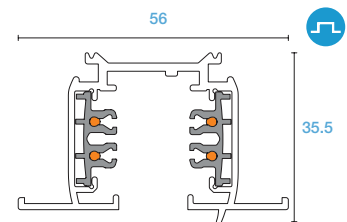

CONNECTOR LEFT



Product Code	EAN	Colour	Price
PRO-0431 L-W	8719747930212	White	£ 10.00
PRO-0431 L-S	8719747930229	Grey	£ 10.00
PRO-0431 L-B	8719747930236	Black	£ 10.00



CONNECTOR RIGHT



Product Code	EAN	Colour	Price
PRO-0431 R-W	8719747930243	White	£ 10.00
PRO-0431 R-S	8719747930250	Grey	£ 10.00
PRO-0431 R-B	8719747930267	Black	£ 10.00



COUPLER



Product Code	EAN	Colour	Price
PRO-0433-W	8719747930304	White	£ 6.00
PRO-0433-S	8719747930311	Grey	£ 6.00
PRO-0433-B	8719747930328	Black	£ 6.00



COUPLER (INSULATION)



Product Code	EAN	Colour	Price
PRO-0433A-W	8719747930335	White	£ 6.00
PRO-0433A-S	8719747930342	Grey	£ 6.00
PRO-0433A-B	8719747930359	Black	£ 6.00



MIDDLE CONNECTOR



Product Code	EAN	Colour	Price
PRO-0434-W	8719747930366	White	£ 18.00
PRO-0434-S	8719747930373	Grey	£ 18.00
PRO-0434-B	8719747930380	Black	£ 18.00



END CAP



Product Code	EAN	Colour	Price
PRO-0432-W	8719747930274	White	£ 1.50
PRO-0432-S	8719747930281	Grey	£ 1.50
PRO-0432-B	8719747930298	Black	£ 1.50



FLEXIBLE CONNECTOR



Product Code	EAN	Colour	Price
PRO-0439-W	8719747930601	White	£ 28.00
PRO-0439-S	8719747930618	Grey	£ 28.00
PRO-0439-B	8719747930625	Black	£ 28.00



ADJUSTABLE CONNECTOR



Product Code	EAN	Colour	Price
PRO-M435-W	8719747930632	White	£ 24.80
PRO-M435-S	8719747930649	Grey	£ 24.80
PRO-M435-B	8719747930656	Black	£ 24.80



X CONNECTOR



Product Code	EAN	Colour	Price
PRO-0437-W	8719747930571	White	£ 32.00
PRO-0437-S	8719747930588	Grey	£ 32.00
PRO-0437-B	8719747930595	Black	£ 32.00



ON THE RIGHT TRACK

L AND T CONNECTORS 3-CIRCUIT TRACK SYSTEM

TWISTED L CONNECTOR (L AND R)

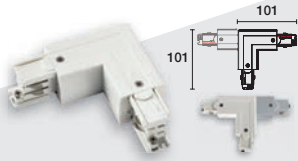

Product Code	EAN	Colour	Price
PRO-M438-W	8719747930663	White	£ 22.00
PRO-M438-S	8719747930670	Grey	£ 22.00
PRO-M438-B	8719747930687	Black	£ 22.00



TWISTED T CONNECTOR L1 -> L2

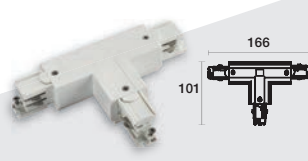

Product Code	EAN	Colour	Price
PRO-M436L-W	8719747930694	White	£ 28.00
PRO-M436L-S	8719747930700	Grey	£ 28.00
PRO-M436L-B	8719747930717	Black	£ 28.00



TWISTED T CONNECTOR R1 -> R2

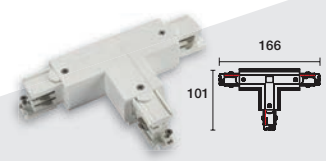

Product Code	EAN	Colour	Price
PRO-M436R-W	871974790724	White	£ 28.00
PRO-M436R-S	871974790731	Grey	£ 28.00
PRO-M436R-B	871974790748	Black	£ 28.00



TWISTED T CONNECTOR

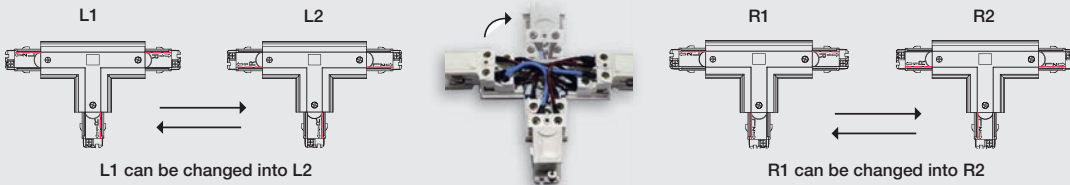

TWISTED L CONNECTOR



L CONNECTOR LEFT



Product Code	EAN	Colour	Price
PRO-0435 L-W	8719747930397	White	£ 22.00
PRO-0435 L-S	8719747930403	Grey	£ 22.00
PRO-0435 L-B	8719747930410	Black	£ 22.00



L CONNECTOR RIGHT



Product Code	EAN	Colour	Price
PRO-0435 R-W	8719747930427	White	£ 22.00
PRO-0435 R-S	8719747930434	Grey	£ 22.00
PRO-0435 R-B	8719747930441	Black	£ 22.00



T CONNECTOR LEFT1

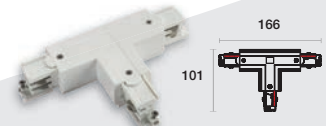

Product Code	EAN	Colour	Price
PRO-0436 L1-W	8719747930458	White	£ 29.00
PRO-0436 L1-S	8719747930465	Grey	£ 29.00
PRO-0436 L1-B	8719747930472	Black	£ 29.00



T CONNECTOR LEFT2

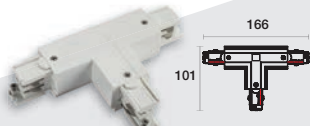

Product Code	EAN	Colour	Price
PRO-0436 L2-W	8719747930489	White	£ 29.00
PRO-0436 L2-S	8719747930496	Grey	£ 29.00
PRO-0436 L2-B	8719747930502	Black	£ 29.00



T CONNECTOR RIGHT1

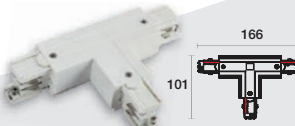

Product Code	EAN	Colour	Price
PRO-0436 R1-W	8719747930519	White	£ 29.00
PRO-0436 R1-S	8719747930526	Grey	£ 29.00
PRO-0436 R1-B	8719747930533	Black	£ 29.00



T CONNECTOR RIGHT2

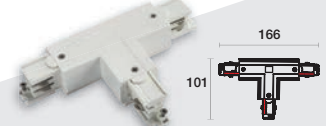

Product Code	EAN	Colour	Price
PRO-0436 R2-W	8719747930540	White	£ 29.00
PRO-0436 R2-S	8719747930557	Grey	£ 29.00
PRO-0436 R2-B	8719747930564	Black	£ 29.00



CONNECTOR COVER



Product Code	EAN	Colour	Price
PRO-R431-W	8719747931103	White	£ 3.00
PRO-R431-S	8719747931110	Grey	£ 3.00
PRO-R431-B	8719747931127	Black	£ 3.00

T CONNECTOR COVER



Product Code	EAN	Colour	Price
PRO-R436-W	8719747931196	White	£ 3.00
PRO-R436-S	8719747931202	Grey	£ 3.00
PRO-R436-B	8719747931219	Black	£ 3.00

X CONNECTOR COVER



Product Code	EAN	Colour	Price
PRO-R437-W	8719747931226	White	£ 3.00
PRO-R437-S	8719747931233	Grey	£ 3.00
PRO-R437-B	8719747931240	Black	£ 3.00

MIDDLE CONNECTOR COVER



Product Code	EAN	Colour	Price
PRO-R434-W	8719747931134	White	£ 4.00
PRO-R434-S	8719747931141	Grey	£ 4.00
PRO-R434-B	8719747931158	Black	£ 4.00

L CONNECTOR COVER



Product Code	EAN	Colour	Price
PRO-R435-W	8719747931165	White	£ 4.00
PRO-R435-S	8719747931172	Grey	£ 4.00
PRO-R435-B	8719747931189	Black	£ 4.00

CONNECTING DIAGRAM (Red line indicates the polarity ridge.)

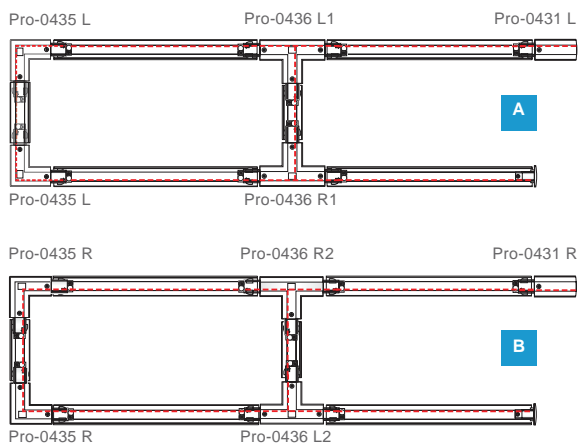

FLOOR VIEW

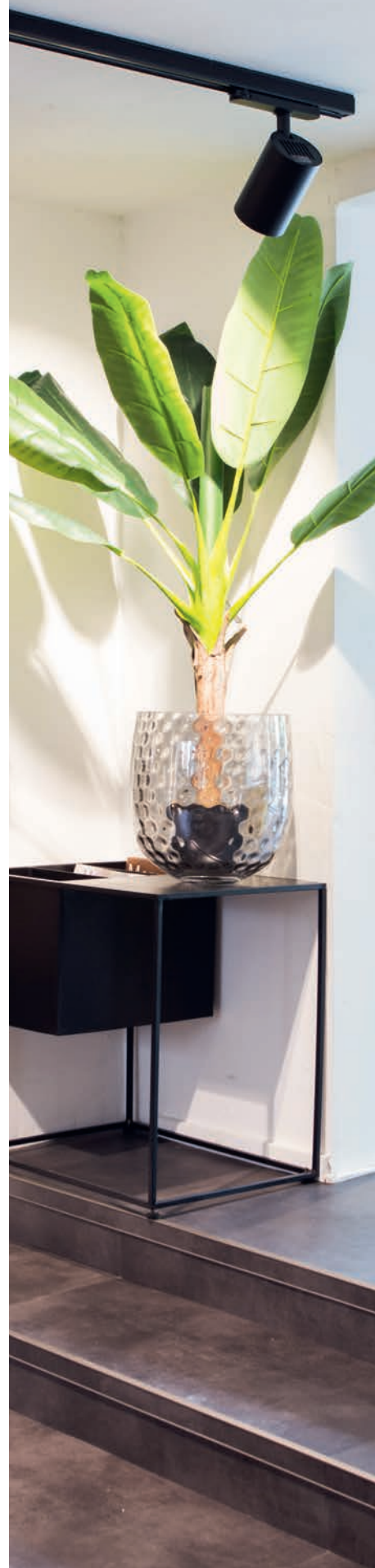



02

3-CIRCUIT DALI TRACK SYSTEM

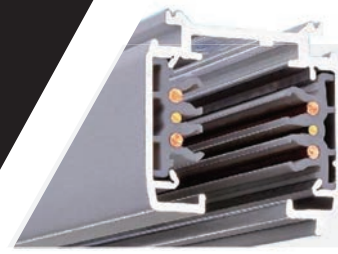

- Create your own smart DALI track system.
- Powergear 3-circuit DALI solutions helps customers to create atmosphere and added value.
- The track is suitable for track lights with a Powergear 3-circuit DALI adapter.
- A comprehensive range of innovative DALI accessories.
- Quick and easy to install.
- Also available in recessed version.

MECHANICAL LOAD DIAGRAM

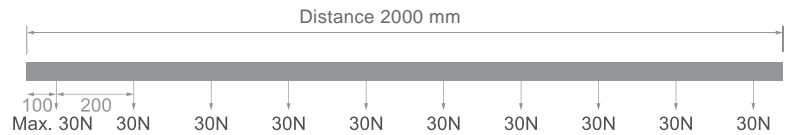
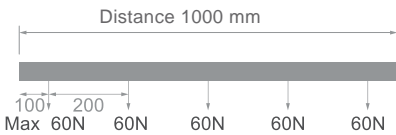

FIXING POINT DIMENSIONS

L / mm	a / mm	b / mm	c / mm	d / mm
1000	125			
2000	125	998		
3000	125		914	1167

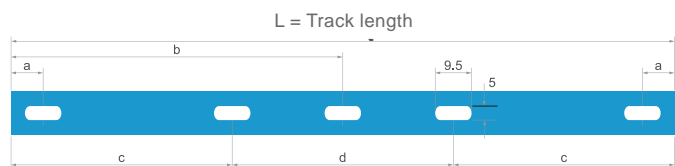

It is recommended to fasten the track at every hole with a screw or suspension kit.

CONNECTING DIAGRAM

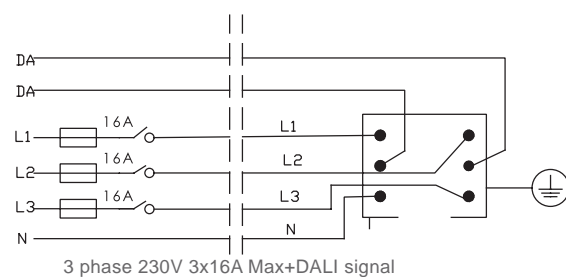
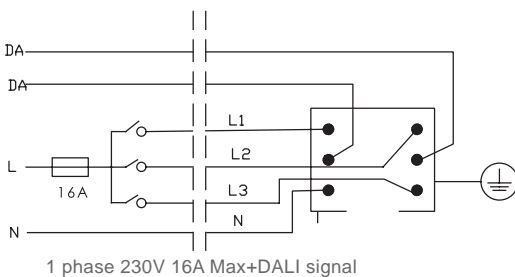

3-CIRCUIT DALI SURFACE MOUNTED TRACK SYSTEM

Product Code	EAN	Product description	Colour	Price
PRO-0610-W	8719747931257	1 M DALI track (1000mm)	White <input type="checkbox"/>	£ 34.90
PRO-0610-S	8719747931264	1 M DALI track (1000mm)	Grey <input checked="" type="checkbox"/>	£ 34.90
PRO-0610-B	8719747931271	1 M DALI track (1000mm)	Black <input checked="" type="checkbox"/>	£ 34.90
<hr/>				
PRO-0620-W	8719747931288	2 M DALI track (2000mm)	White <input type="checkbox"/>	£ 64.90
PRO-0620-S	8719747931295	2 M DALI track (2000mm)	Grey <input checked="" type="checkbox"/>	£ 64.90
PRO-0620-B	8719747931301	2 M DALI track (2000mm)	Black <input checked="" type="checkbox"/>	£ 64.90
<hr/>				
PRO-0630-W	8719747931318	3 M DALI track (3000mm)	White <input type="checkbox"/>	£ 89.90
PRO-0630-S	8719747931325	3 M DALI track (3000mm)	Grey <input checked="" type="checkbox"/>	£ 89.90
PRO-0630-B	8719747931332	3 M DALI track (3000mm)	Black <input checked="" type="checkbox"/>	£ 89.90

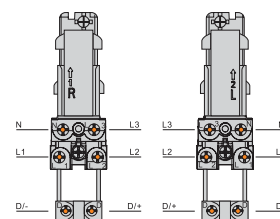
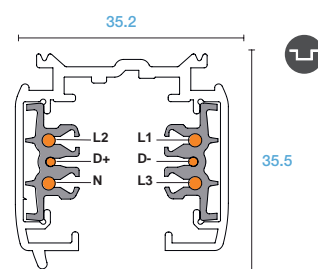

3-CIRCUIT DALI RECESSED TRACK SYSTEM

Product Code	EAN	Product description	Colour	Price
PRO-R610-W	8719747931738	1 M DALI track (1000mm) recessed	White <input type="checkbox"/>	£ 39.90
PRO-R610-S	8719747931745	1 M DALI track (1000mm) recessed	Grey <input checked="" type="checkbox"/>	£ 39.90
PRO-R610-B	8719747931752	1 M DALI track (1000mm) recessed	Black <input checked="" type="checkbox"/>	£ 39.90
<hr/>				
PRO-R620-W	8719747931769	2 M DALI track (2000mm) recessed	White <input type="checkbox"/>	£ 69.90
PRO-R620-S	8719747931776	2 M DALI track (2000mm) recessed	Grey <input checked="" type="checkbox"/>	£ 69.90
PRO-R620-B	8719747931783	2 M DALI track (2000mm) recessed	Black <input checked="" type="checkbox"/>	£ 69.90
<hr/>				
PRO-R630-W	8719747931790	3 M DALI track (3000mm) recessed	White <input type="checkbox"/>	£ 94.90
PRO-R630-S	8719747931806	3 M DALI track (3000mm) recessed	Grey <input checked="" type="checkbox"/>	£ 94.90
PRO-R630-B	8719747931813	3 M DALI track (3000mm) recessed	Black <input checked="" type="checkbox"/>	£ 94.90

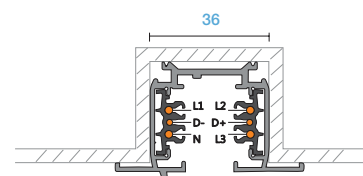
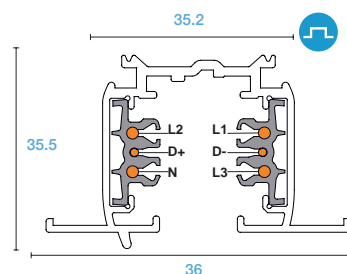

CONNECTOR LEFT DALI 3-CIRCUIT



Product Code	EAN	Colour	Price
PRO-D631 L-W	8719747931370	White	£ 12.00
PRO-D631 L-S	8719747931387	Grey	£ 12.00
PRO-D631 L-B	8719747931394	Black	£ 12.00



CONNECTOR RIGHT DALI 3-CIRCUIT



Product Code	EAN	Colour	Price
PRO-D631 R-W	8719747931400	White	£ 12.00
PRO-D631 R-S	8719747931417	Grey	£ 12.00
PRO-D631 R-B	8719747931424	Black	£ 12.00



COUPLER DALI 3-CIRCUIT



Product Code	EAN	Colour	Price
PRO-D633-W	8719747931431	White	£ 8.00
PRO-D633-S	8719747931448	Grey	£ 8.00
PRO-D633-B	8719747931455	Black	£ 8.00



MIDDLE CONNECTOR DALI 3-CIRCUIT



Product Code	EAN	Colour	Price
PRO-D634-W	8719747931462	White	£ 24.00
PRO-D634-S	8719747931479	Grey	£ 24.00
PRO-D634-B	8719747931486	Black	£ 24.00



END CAP



Product Code	EAN	Colour	Price
PRO-0432-W	8719747930274	White	£ 1.50
PRO-0432-S	8719747930281	Grey	£ 1.50
PRO-0432-B	8719747930298	Black	£ 1.50



FLEXIBLE CONNECTOR DALI 3-CIRCUIT



Product Code	EAN	Colour	Price
PRO-D639-W	8719747931554	White	£ 35.00
PRO-D639-S	8719747931561	Grey	£ 35.00
PRO-D639-B	8719747931578	Black	£ 35.00



X CONNECTOR DALI 3-CIRCUIT

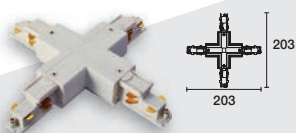

Product Code	EAN	Colour	Price
PRO-D637-W	8719747931585	White	£ 47.00
PRO-D637-S	8719747931592	Grey	£ 47.00
PRO-D637-B	8719747931608	Black	£ 47.00



L AND T CONNECTORS 3-CIRCUIT DALI TRACK SYSTEM

L CONNECTOR DALI LEFT 3-CIRCUIT



Product Code	EAN	Colour	Price
PRO-D635 L-W	8719747931493	White	£ 25.00
PRO-D635 L-S	8719747931509	Grey	£ 25.00
PRO-D635 L-B	8719747931516	Black	£ 25.00



L CONNECTOR DALI RIGHT 3-CIRCUIT



Product Code	EAN	Colour	Price
PRO-D635 R-W	8719747931523	White	£ 25.00
PRO-D635 R-S	8719747931530	Grey	£ 25.00
PRO-D635 R-B	8719747931547	Black	£ 25.00



T CONNECTOR DALI LEFT1 3-CIRCUIT



Product Code	EAN	Colour	Price
PRO-D636 L1-W	8719747931646	White	£ 37.00
PRO-D636 L1-S	8719747931653	Grey	£ 37.00
PRO-D636 L1-B	8719747931660	Black	£ 37.00



T CONNECTOR DALI LEFT2 3-CIRCUIT



Product Code	EAN	Colour	Price
PRO-D636 L2-W	8719747931677	White	£ 37.00
PRO-D636 L2-S	8719747931684	Grey	£ 37.00
PRO-D636 L2-B	8719747931691	Black	£ 37.00



T CONNECTOR DALI RIGHT1 3-CIRCUIT



Product Code	EAN	Colour	Price
PRO-D636 R1-W	8719747931707	White	£ 37.00
PRO-D636 R1-S	8719747931714	Grey	£ 37.00
PRO-D636 R1-B	8719747931721	Black	£ 37.00



T CONNECTOR DALI RIGHT2 3-CIRCUIT



Product Code	EAN	Colour	Price
PRO-D636 R2-W	8719747931615	White	£ 37.00
PRO-D636 R2-S	8719747931622	Grey	£ 37.00
PRO-D636 R2-B	8719747931639	Black	£ 37.00



CONNECTING DIAGRAM (Red line indicates the polarity ridge.)

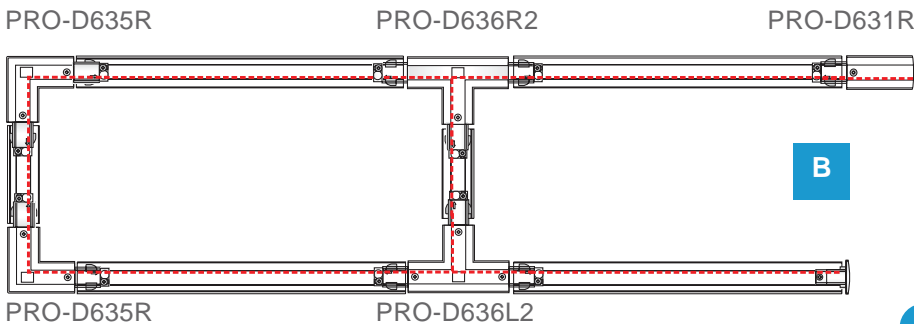
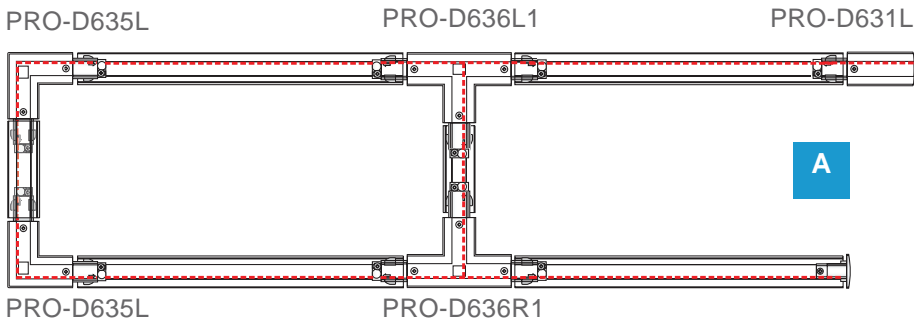

FLOOR VIEW

CONNECTOR COVER



Product Code	EAN	Colour	Price
PRO-R631-W	8719747931820	White	£ 3.00
PRO-R631-S	8719747931837	Grey	£ 3.00
PRO-R631-B	8719747931844	Black	£ 3.00



T CONNECTOR COVER



Product Code	EAN	Colour	Price
PRO-R436-W	8719747931196	White	£ 4.00
PRO-R436-S	8719747931202	Grey	£ 4.00
PRO-R436-B	8719747931219	Black	£ 4.00



L CONNECTOR COVER



Product Code	EAN	Colour	Price
PRO-R435-W	8719747931165	White	£ 4.00
PRO-R435-S	8719747931172	Grey	£ 4.00
PRO-R435-B	8719747931189	Black	£ 4.00



X CONNECTOR COVER



Product Code	EAN	Colour	Price
PRO-R437-W	8719747931226	White	£ 5.00
PRO-R437-S	8719747931233	Grey	£ 5.00
PRO-R437-B	8719747931240	Black	£ 5.00



MIDDLE CONNECTOR COVER

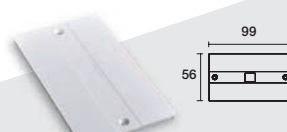

Product Code	EAN	Colour	Price
PRO-R434-W	8719747931134	White	£ 4.00
PRO-R434-S	8719747931141	Grey	£ 4.00
PRO-R434-B	8719747931158	Black	£ 4.00





03

1-CIRCUIT DALI TRACK SYSTEM



SURFACE MOUNTED

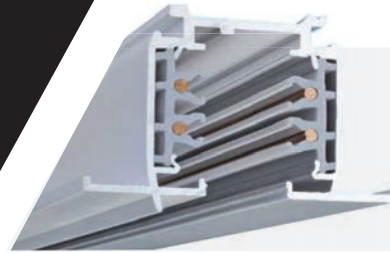

RECESSED

- Create your own DALI system with standard 3-circuit track
- Powergear 1-circuit DALI solutions helps customers to create atmosphere.
- Powergear standard 3-circuit track can be used as a 1-circuit system with DALI connection.
- Suitable when the track system is not too comprehensive and the budget is limited.
- DALI trackspots can be controlled by standard 3-circuit track.
- A comprehensive range of innovative DALI 1-circuit accessories.
- Quick and easy to install.

MECHANICAL LOAD DIAGRAM

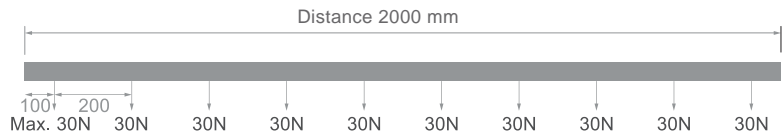
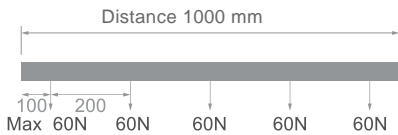

FIXING POINT DIMENSIONS

L / mm	a / mm	b / mm	c / mm	d / mm
1000	125			
2000	125	998		
3000	125		914	1167

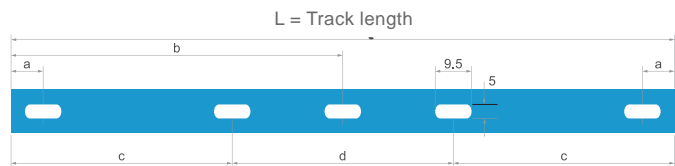

It is recommended to fasten the track at every hole with a screw or suspension kit.

CONNECTING DIAGRAM

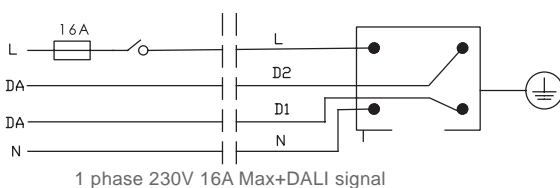

1-CIRCUIT DALI SURFACE MOUNTED TRACK SYSTEM

Product Code	EAN	Product description	Colour	Price
PRO-0410-W	8719747930007	1 M track (1000mm)	White 	£ 24.90
PRO-0410-S	8719747930014	1 M track (1000mm)	Grey 	£ 24.90
PRO-0410-B	8719747930021	1 M track (1000mm)	Black 	£ 24.90
<hr/>				
PRO-0420-W	8719747930069	2 M track (2000mm)	White 	£ 44.90
PRO-0420-S	8719747930076	2 M track (2000mm)	Grey 	£ 44.90
PRO-0420-B	8719747930083	2 M track (2000mm)	Black 	£ 44.90
<hr/>				
PRO-0430-W	8719747930120	3 M track (3000mm)	White 	£ 69.90
PRO-0430-S	8719747930137	3 M track (3000mm)	Grey 	£ 69.90
PRO-0430-B	8719747930144	3 M track (3000mm)	Black 	£ 69.90

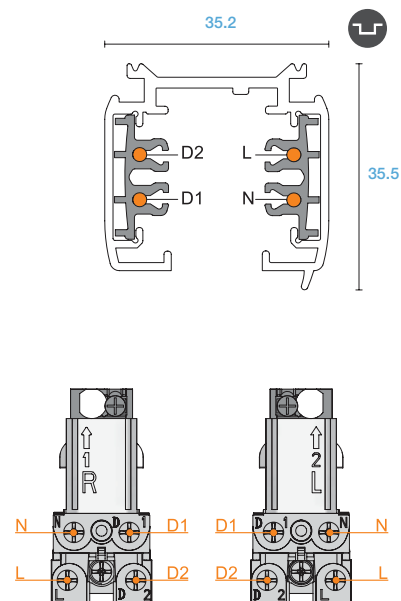

1-CIRCUIT DALI RECESSED MOUNTED TRACK SYSTEM

Product Code	EAN	Product description	Colour	Price
PRO-R410-W	8719747931011	1 M track (1000mm)	White 	£ 29.90
PRO-R410-S	8719747931028	1 M track (1000mm)	Grey 	£ 29.90
PRO-R410-B	8719747931035	1 M track (1000mm)	Black 	£ 29.90
<hr/>				
PRO-R420-W	8719747931042	2 M track (2000mm)	White 	£ 49.90
PRO-R420-S	8719747931059	2 M track (2000mm)	Grey 	£ 49.90
PRO-R420-B	8719747931066	2 M track (2000mm)	Black 	£ 49.90
<hr/>				
PRO-R430-W	8719747931073	3 M track (3000mm)	White 	£ 79.90
PRO-R430-S	8719747931080	3 M track (3000mm)	Grey 	£ 79.90
PRO-R430-B	8719747931097	3 M track (3000mm)	Black 	£ 79.90

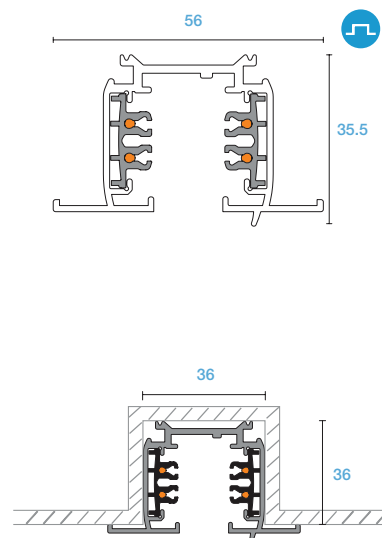

CONNECTOR LEFT DALI 1-CIRCUIT



Product Code	EAN	Colour	Price
PRO-D431 L-W	8719747931882	White	£ 11.00
PRO-D431 L-S	8719747931899	Grey	£ 11.00
PRO-D431 L-B	8719747931905	Black	£ 11.00



CONNECTOR RIGHT DALI 1-CIRCUIT



Product Code	EAN	Colour	Price
PRO-D431 R-W	8719747931912	White	£ 11.00
PRO-D431 R-S	8719747931929	Grey	£ 11.00
PRO-D431 R-B	8719747931936	Black	£ 11.00



COUPLER



Product Code	EAN	Colour	Price
PRO-0433-W	8719747930304	White	£ 6.00
PRO-0433-S	8719747930311	Grey	£ 6.00
PRO-0433-B	8719747930328	Black	£ 6.00



COUPLER (INSULATION)



Product Code	EAN	Colour	Price
PRO-0433A-W	8719747930335	White	£ 6.00
PRO-0433A-S	8719747930342	Grey	£ 6.00
PRO-0433A-B	8719747930359	Black	£ 6.00



MIDDLE CONNECTOR DALI 1-CIRCUIT



Product Code	EAN	Colour	Price
PRO-D434-W	8719747932001	White	£ 25.00
PRO-D434-S	8719747932018	Grey	£ 25.00
PRO-D434-B	8719747932025	Black	£ 25.00



END CAP

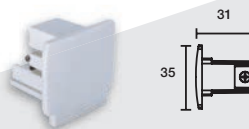

Product Code	EAN	Colour	Price
PRO-0432-W	8719747930274	White	£ 1.50
PRO-0432-S	8719747930281	Grey	£ 1.50
PRO-0432-B	8719747930298	Black	£ 1.50



FLEXIBLE CONNECTOR DALI 1-CIRCUIT



Product Code	EAN	Colour	Price
PRO-D439-W	8719747932247	White	£ 30.00
PRO-D439-S	8719747932254	Grey	£ 30.00
PRO-D439-B	8719747932261	Black	£ 30.00



X CONNECTOR DALI 1-CIRCUIT

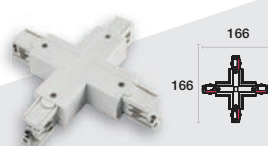

Product Code	EAN	Colour	Price
PRO-D437-W	8719747932216	White	£ 40.00
PRO-D437-S	8719747932223	Grey	£ 40.00
PRO-D437-B	8719747932230	Black	£ 40.00

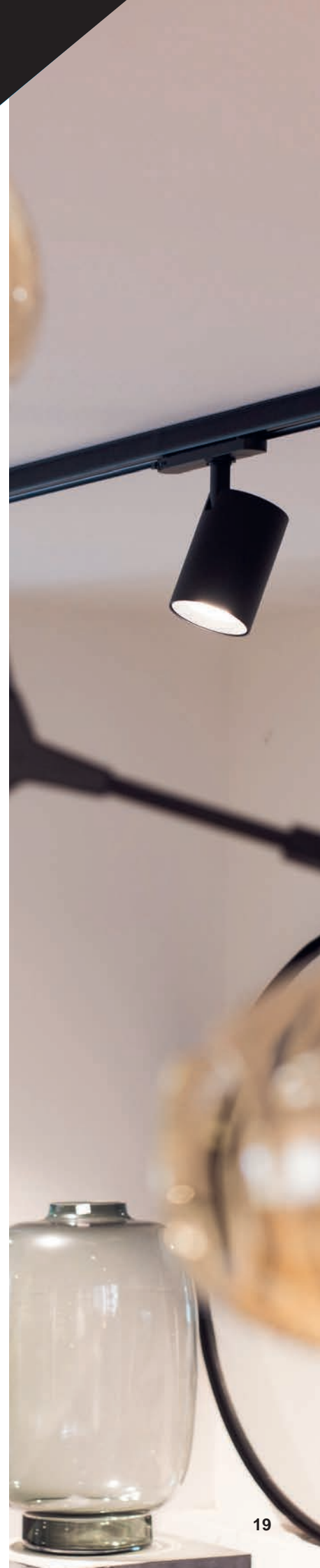

L AND T CONNECTORS 1-CIRCUIT DALI TRACK SYSTEM

L CONNECTOR DALI LEFT 1-CIRCUIT



Product Code	EAN	Colour	Price
PRO-D435 L-W	8719747932032	White	£ 22.00
PRO-D435 L-S	8719747932049	Grey	£ 22.00
PRO-D435 L-B	8719747932056	Black	£ 22.00



L CONNECTOR DALI RIGHT 1-CIRCUIT



Product Code	EAN	Colour	Price
PRO-D435 R-W	8719747932063	White	£ 22.00
PRO-D435 R-S	8719747932070	Grey	£ 22.00
PRO-D435 R-B	8719747932087	Black	£ 22.00



T CONNECTOR DALI LEFT1 1-CIRCUIT

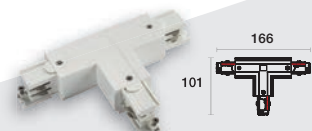

Product Code	EAN	Colour	Price
PRO-D436 L1-W	8719747932094	White	£ 29.00
PRO-D436 L1-S	8719747932100	Grey	£ 29.00
PRO-D436 L1-B	8719747932117	Black	£ 29.00



T CONNECTOR DALI LEFT2 1-CIRCUIT

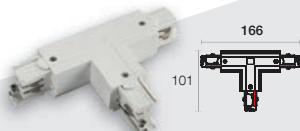

Product Code	EAN	Colour	Price
PRO-D436 L2-W	8719747932124	White	£ 29.00
PRO-D436 L2-S	8719747932131	Grey	£ 29.00
PRO-D436 L2-B	8719747932148	Black	£ 29.00



T CONNECTOR DALI RIGHT1 1-CIRCUIT

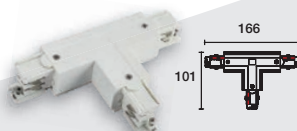

Product Code	EAN	Colour	Price
PRO-D436 R1-W	8719747932155	White	£ 29.00
PRO-D436 R1-S	8719747932162	Grey	£ 29.00
PRO-D436 R1-B	8719747932179	Black	£ 29.00



T CONNECTOR DALI RIGHT2 1-CIRCUIT

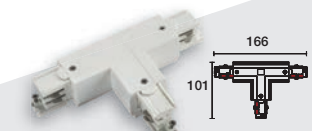

Product Code	EAN	Colour	Price
PRO-D436	8719747932186	White	£ 29.00
PRO-D436 R2-S	8719747932193	Grey	£ 29.00
PRO-D436 R2-B	8719747932209	Black	£ 29.00



CONNECTING DIAGRAM (Red line indicates the polarity ridge.)

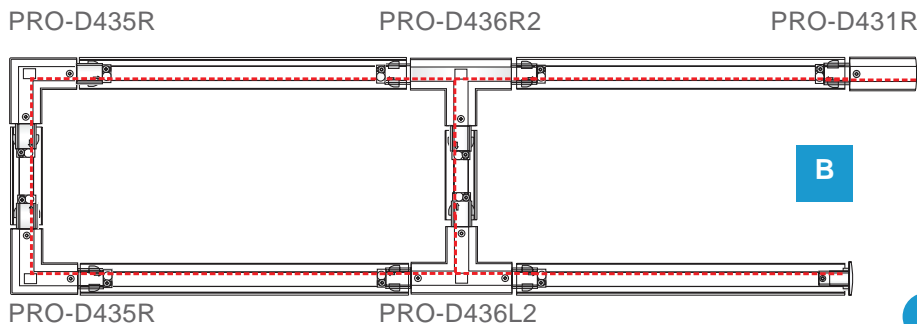
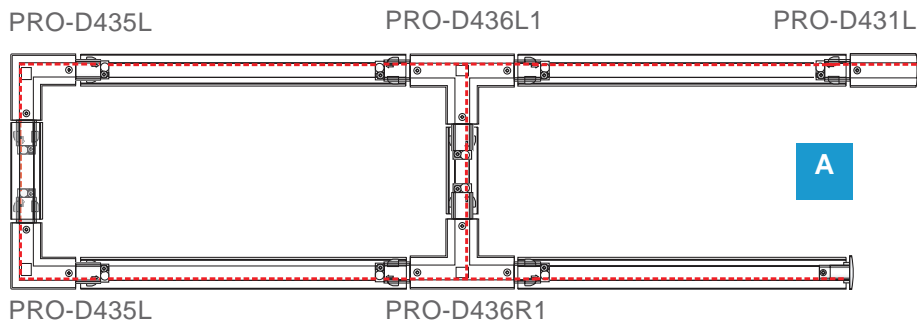

FLOOR VIEW

CONNECTOR COVER

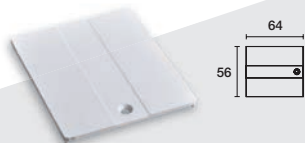

Product Code	EAN	Colour	Price
PRO-R431-W	8719747931103	White	£ 3.00
PRO-R431-S	8719747931110	Grey	£ 3.00
PRO-R431-B	8719747931127	Black	£ 3.00



T CONNECTOR COVER



Product Code	EAN	Colour	Price
PRO-R436-W	8719747931196	White	£ 4.00
PRO-R436-S	8719747931202	Grey	£ 4.00
PRO-R436-B	8719747931219	Black	£ 4.00



X CONNECTOR COVER



Product Code	EAN	Colour	Price
PRO-R437-W	8719747931226	White	£ 5.00
PRO-R437-S	8719747931233	Grey	£ 5.00
PRO-R437-B	8719747931240	Black	£ 5.00



MIDDLE CONNECTOR COVER

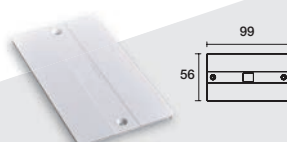

Product Code	EAN	Colour	Price
PRO-R434-W	8719747931134	White	£ 4.00
PRO-R434-S	8719747931141	Grey	£ 4.00
PRO-R434-B	8719747931158	Black	£ 4.00



L CONNECTOR COVER



Product Code	EAN	Colour	Price
PRO-R435-W	8719747931165	White	£ 4.00
PRO-R435-S	8719747931172	Grey	£ 4.00
PRO-R435-B	8719747931189	Black	£ 4.00





04

TRACK SUSPENSION & GENERAL ACCESSORIES

- Making the track system design more flexible and versatile.
- Compatible with a new robust single circuit track system.
- Custom made option for suspension kits wire lengths.
- Track plan extension possibility of via fixed standard or DALI monopoints
- Quick and easy to install.

SUSPENSION CONNECTION CLAMP

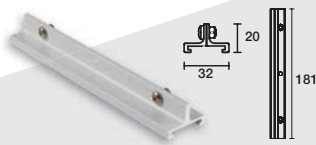

Product Code	EAN	Colour	Price
PRO-0418SK-W	8719747930847	White	£ 7.00
PRO-0418SK-S	8719747930854	Grey	£ 7.00
PRO-0418SK-B	8719747930861	Black	£ 7.00

ROD SUSPENSION EZCLICK

suspension kit with 1m rod



Product Code	EAN	Colour	Price
PRO-EZ0447-W	8719747930755	White	£ 19.00
PRO-EZ0447-S	8719747930762	Grey	£ 19.00
PRO-EZ0447-B	8719747930779	Black	£ 19.00

WIRE SUSPENSION EZCLICK 5M NEW

suspension kit with 5m steel wire



Product Code	EAN	Colour	Price
PRO-EZ0449-W	8719747932483	White	£ 11.00
PRO-EZ0449-S	8719747932490	Grey	£ 11.00
PRO-EZ0449-B	8719747932506	Black	£ 11.00

T-BAR EZCLICK



Product Code	EAN	Colour	Price
PRO-M146T-W	8719747930816	White 	£ 5.00
PRO-M146T-S	8719747930823	Grey 	£ 5.00
PRO-M146T-B	8719747930830	Black 	£ 5.00

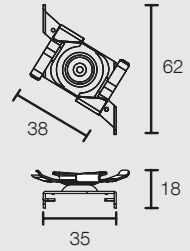

T-BAR EZCLICK MOUNTING INSTRUCTION

1 Adjust the EZCLICK Mounting Kit's direction, put it vertically on to the T-Bar ceiling, and then rotate right and fix (as picture shows).

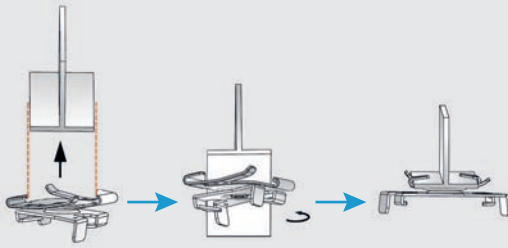

2 Adjust the EZCLICK Mounting Kit's direction, put the track vertically into the EZCLICK Mounting Kit, rotate left and fix (as picture shows)

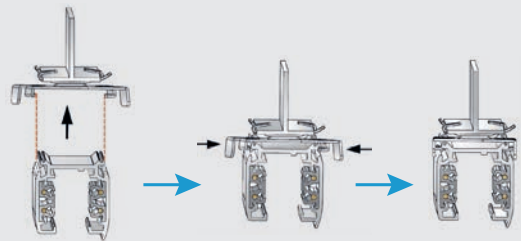

REINFORCEMENT PLATE

reinforcement plate with 5m steel suspension wire



Product Code	EAN	Colour	Price
PRO-M147-W	8719747932643	White 	£ 14.00
PRO-M147-S	8719747932650	Grey 	£ 14.00
PRO-M147-B	8719747932667	Black 	£ 14.00

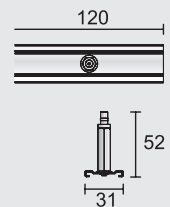

REINFORCEMENT PLATE MOUNTING INSTRUCTION

1 Put the track into the reinforcement plate parallel (as picture shows)

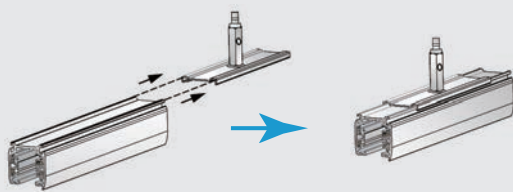

2 Release the start valve, press and get the wire through the EZCLICK mounting kit, rotate tight the start valve and lock the wirerope (as picture shows)

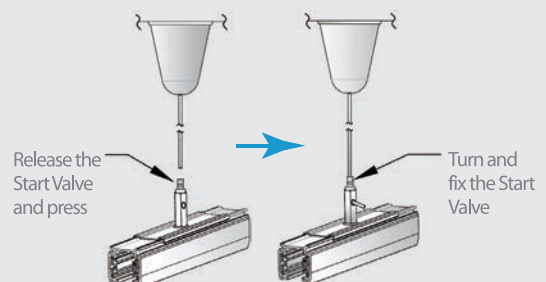

MOUNTING CLAMP

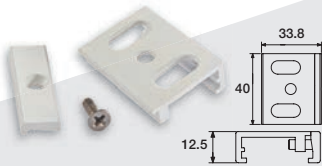

Product Code	EAN	Colour	Price
PRO-04SK-W	8719747930939	White	£ 3.00
PRO-04SK-S	8719747930946	Grey	£ 3.00
PRO-04SK-B	8719747930953	Black	£ 3.00



SUSPENSION HOOK



Product Code	EAN	Colour	Price
PRO-M142-W	8719747930878	White	£ 3.00
PRO-M142-S	8719747930885	Grey	£ 3.00
PRO-M142-B	8719747930892	Black	£ 3.00



TRACK COVER STRIP 3M

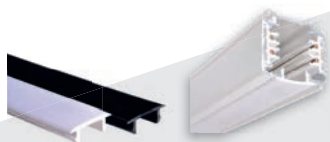

Product Code	EAN	Colour	Price
PRO-CS04300-W	8719747932438	White	£ 4.00
PRO-CS04300-B	8719747932445	Black	£ 4.00



MECHANICAL ADAPTER



Product Code	EAN	Colour	Price
PRO-0449-W	8719747930908	White	£ 10.00
PRO-0449-S	8719747930915	Grey	£ 10.00
PRO-0449-B	8719747930922	Black	£ 10.00



FIXED MONOPOINT FOR TRACK ADAPTER

universal

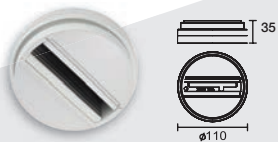

Product Code	EAN	Colour	Price
PRO-C100-W	8719747930960	White	£ 26.00
PRO-C100-S	8719747930977	Grey	£ 26.00
PRO-C100-B	8719747930984	Black	£ 26.00



FIXED MONOPOINT DALI FOR TRACK ADAPTER



Product Code	EAN	Colour	Price
PRO-C150-W	8719747933213	White	£ 23.00
PRO-C150-S	8719747933220	Grey	£ 23.00
PRO-C150-B	8719747933237	Black	£ 23.00



SCHUKO ADAPTER



Product Code	EAN	Colour	Price
PRO-4230V-W	8719747930991	White	£ 25.00
PRO-4230V-B	8719747931004	Black	£ 25.00



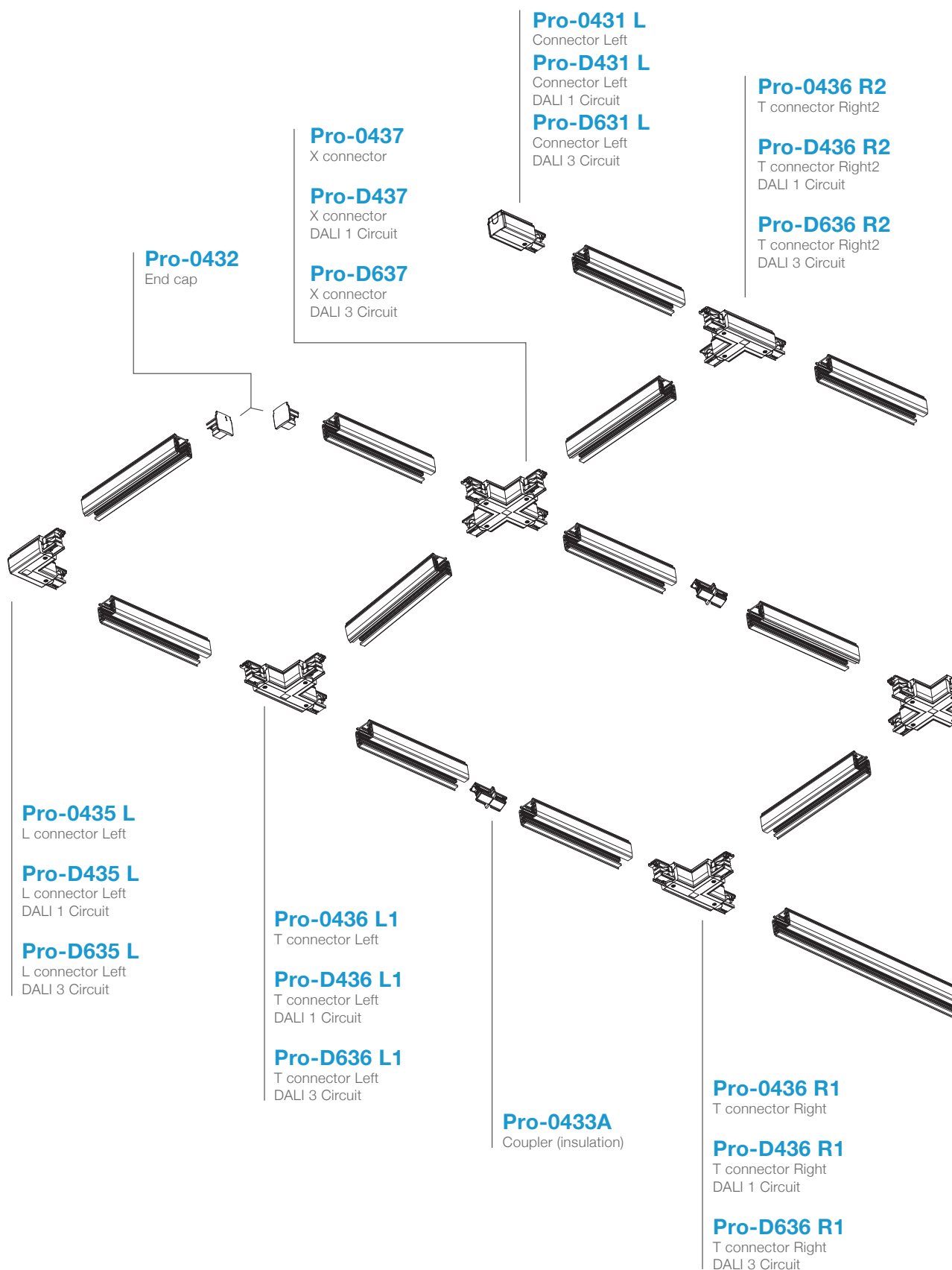

Pro-0436 L2

T connector Left

Pro-D436 L2

T connector Left
DALI 1 Circuit

Pro-D636 L2

T connector Left
DALI 3 Circuit

Pro-0413 R

Connector Right

Pro-D413 R

Connector Right
DALI 1 Circuit

Pro-D613 R

Connector Right
DALI 3 Circuit

Pro-0434

Middle connector

Pro-D434

Middle connector
DALI 1 Circuit

Pro-D634

Middle connector
DALI 3 Circuit

Pro-0435 R

L connector Right

Pro-D435 R

L connector Right
DALI 1 Circuit

Pro-D635 R

L connector Right
DALI 3 Circuit

Pro-M435

Adjustable connector

Pro-0433

Coupler
Coupler DALI 1 Circuit

Pro-D633

Coupler
DALI 3 Circuit

Pro-M435

Adjustable connector



05

ADAPTERS

- Great compatibility to all major lighting track systems.
- For the OEM market Powergear offers a wide range of 3 circuit and 3 circuit DALI adapters.
- Innovative range of in-track drivers giving new opportunities for minimalistic design in lighting fixtures.
- Multi current driver is concealed in the adapter.
- Connected solutions based on Casambi technology

SMART 3-CIRCUIT ADAPTER



Product Code	EAN	Colour	Price
PRO-0222-W	8719747930182	White	£ 8.00
PRO-0222-S	8719747930199	Grey	£ 8.00
PRO-0222-B	8719747930205	Black	£ 8.00

FMax: 50N

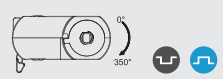

CLASSIC 3-CIRCUIT ADAPTER

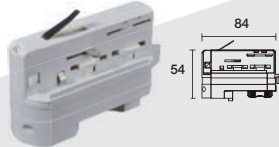

Product Code	EAN	Colour	Price
PRO-0440-W	8719747932346	White	£ 9.00
PRO-0440-S	8719747932353	Grey	£ 9.00
PRO-0440-B	8719747932360	Black	£ 9.00

FMax: 100N



DALI 3-CIRCUIT ADAPTER

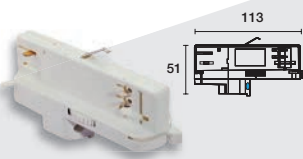

Product Code	EAN	Colour	Price
PRO-D680-W	8719747931349	White	£ 14.00
PRO-D680-S	8719747931356	Grey	£ 14.00
PRO-D680-B	8719747931363	Black	£ 14.00

FMax: 100N

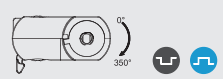

CLASSIC 1-CIRCUIT ADAPTER

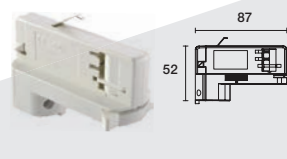

Product Code	EAN	Colour	Price
PRO-D480-W	8719747931851	White	£ 12.00
PRO-D480-S	8719747931868	Grey	£ 12.00
PRO-D480-B	8719747931875	Black	£ 12.00

FMax: 100N





NIPPLE M10X8

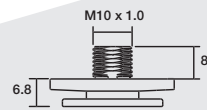

Product Code	EAN	Colour	Package
PRO-M10-008-02	8719747933510	Alu 	100
PRO-M10-008-02-W	8719747932513	White 	100
PRO-M10-008-02-S	8719747932674	Grey 	100
PRO-M10-008-02-B	8719747932520	Black 	100

NIPPLE M10X12

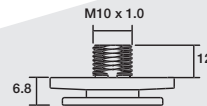

Product Code	EAN	Colour	Package
PRO-M10-012-02	8719747932322	Alu 	100
PRO-M10-012-02-W	8719747932537	White 	100
PRO-M10-012-02-S	8719747932681	Grey 	100
PRO-M10-012-02-B	8719747932544	Black 	100

PVC STRAIN RELIEF

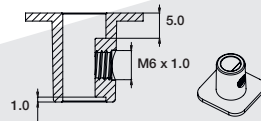

Product Code	EAN	Colour	Package
PRO-M510-W	8719747933244	White 	100
PRO-M510-S	8719747933251	Grey 	100
PRO-M510-B	8719747933268	Black 	100

PVC NIPPLE STRAIN RELIEF M10

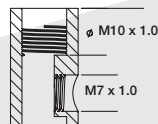

Product Code	EAN	Colour	Package
PRO-M10-008-PVC-W	8719747933152	White 	100
PRO-M10-008-PVC-S	8719747933169	Grey 	100
PRO-M10-008-PVC-B	8719747933176	Black 	100

TOOL FOR WIRING



Product Code	EAN	Colour	Price
PRO-0222-001-04	8719747932308		£ 39.90

ULTIMATE ADAPTER



Specifications 3 circuit adapter:
 Flicker Free, Ripple Free
 Input: 220-240Vac, 50/60Hz
 Output: 25-42Vdc
 Dip-switches for easy output current selection
 Lifetime: 50.000 hours
 Fmax: 50N
 Certificate: ENEC/CE/CCC

Product Code	EAN	Colour	Price
PRO-UA420-W	8719747933985	White 	£ 21.90
PRO-UA420-S	8719747933992	Grey 	£ 21.90
PRO-UA420-B	8719747934005	Black 	£ 21.90
PRO-UA430-W	8719747934012	White 	£ 24.90
PRO-UA430-S	8719747934029	Grey 	£ 24.90
PRO-UA430-B	8719747934036	Black 	£ 24.90
PRO-UA440-W	8719747934043	White 	£ 25.90
PRO-UA440-S	8719747934050	Grey 	£ 25.90
PRO-UA440-B	8719747934067	Black 	£ 25.90

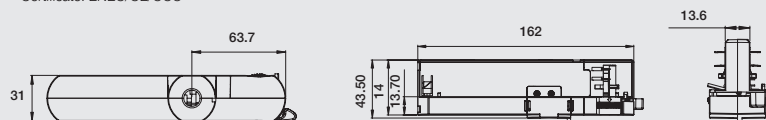

PRO-UA420	1	2	Power
250mA	○	○	11W
350mA	○	●	15W
450mA	●	○	19W
500mA	●	●	21W

PRO-UA430	1	2	Power
600mA	○	○	25W
700mA	○	●	29W
750mA	●	○	32W
800mA	●	●	34W

PRO-UA440	1	2	Power
850mA	○	○	36W
900mA	○	●	38W
950mA	●	○	40W
1050mA	●	●	44W

**ULTIMATE ADAPTER
DALI 325-700MA**



Specifications:

Flicker Free
 Input: 220-240Vac, 50/60Hz
 Output: 5-44Vdc, 59Vdc Max.
 PF>0.9, THD<15%
 ta: 0°C - 35°C, tc: 85°C
 Fmax: 50N
 Unloaded protection, Short-circuit Protection,
 Overvoltage Protection
 Certificate: ENEC/CE/CCC

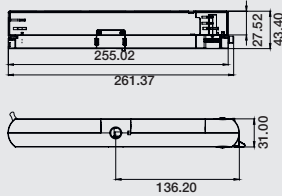

Product Code	EAN	Colour	Price
PRO-T6700-W	8719747932612	White	£ 63.90
PRO-T6700-S	8719747932629	Grey	£ 63.90
PRO-T6700-B	8719747932636	Black	£ 63.90

PRO-T6700	1	2	3	4	Power
325mA	○	○	○	○	14W
350mA	○	○	○	●	15.5W
375mA	○	○	●	○	16.5W
400mA	○	○	●	●	17.5W
425mA	○	●	○	○	18.5W
450mA	○	●	○	●	19.5W
475mA	○	●	●	○	21W
500mA	○	●	●	●	22W



PRO-T6700	1	2	3	4	Power
525mA	●	○	○	○	23W
550mA	●	○	○	●	24W
575mA	●	○	●	○	25W
600mA	●	○	●	●	26.5W
625mA	●	●	○	○	27.5W
650mA	●	●	○	●	28.5W
675mA	●	●	●	○	29.5W
700mA	●	●	●	●	31W

**ULTIMATE ADAPTER
675-1050MA**



Specifications:

Flicker Free
 Input: 220-240Vac, 50/60Hz
 Output: 5-44Vdc, 59Vdc Max.
 PF>0.9, THD<15%
 ta: 0°C - 35°C, tc: 85°C
 Fmax: 50N
 Unloaded protection, Short-circuit Protection,
 Overvoltage Protection
 Certificate: ENEC/CE/CCC

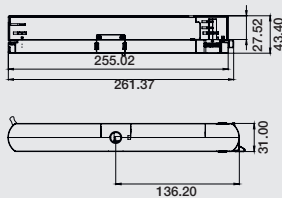

Product Code	EAN	Colour	Price
PRO-T61050-W	8719747934104	White	£ 63.90
PRO-T61050-S	8719747934111	Grey	£ 63.90
PRO-T61050-B	8719747934128	Black	£ 63.90

PRO-T61050	1	2	3	4	Power
675mA	○	○	○	○	28W
700mA	○	○	○	●	29W
725mA	○	○	●	○	30W
750mA	○	○	●	●	31W
775mA	○	●	○	○	32W
800mA	○	●	○	●	33W
825mA	○	●	●	○	33W
850mA	○	●	●	●	34W



PRO-T61050	1	2	3	4	Power
875mA	●	○	○	○	35W
900mA	●	○	○	●	36W
925mA	●	○	●	○	37W
950mA	●	○	●	●	38W
975mA	●	●	○	○	39W
1000mA	●	●	○	●	40W
1025mA	●	●	●	○	40W
1050mA	●	●	●	●	40W

**ULTIMATE ADAPTER
CASAMBI 325-700MA**



Specifications:

Flicker Free
 Input: 220-240Vac, 50/60Hz
 Output: 5-42Vdc, 59Vdc Max.
 PF>0.9, THD<15%
 ta: 0°C - 35°C, tc: 90°C
 Fmax: 50N
 Unloaded protection, Short-circuit Protection,
 Overvoltage Protection
 Certificate: ENEC/CE/CCC

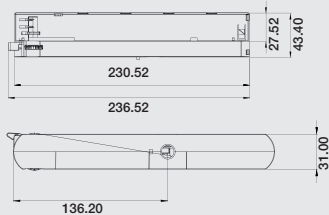

Product Code	EAN	Colour	Price
PRO-4700CB-W	8719747934074	White	£ 149.90
PRO-4700CB-S	8719747934081	Grey	£ 149.90
PRO-4700CB-B	8719747934098	Black	£ 149.90

PRO-4700CB	1	2	3	4	Power
325mA	○	○	○	○	14W
350mA	○	○	○	●	15.5W
375mA	○	○	●	○	16.5W
400mA	○	○	●	●	17.5W
425mA	○	●	○	○	18.5W
450mA	○	●	○	●	19.5W
475mA	○	●	●	○	21W
500mA	○	●	●	●	22W



PRO-4700CB	1	2	3	4	Power
525mA	●	○	○	○	23W
550mA	●	○	○	●	24W
575mA	●	○	●	○	25W
600mA	●	○	●	●	26.5W
625mA	●	●	○	○	27.5W
650mA	●	●	○	●	28.5W
675mA	●	●	●	○	29.5W
700mA	●	●	●	●	31W



06

48V TRACK SYSTEM

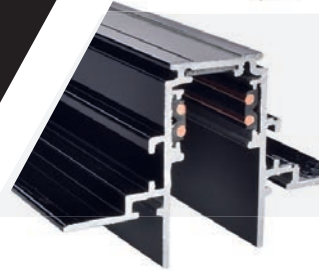
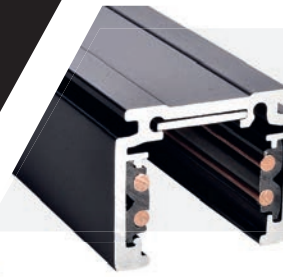

- High quality 48V track system for the professional lighting market.
- Maximum freedom to create the ultimate track plan.
- Modular joint, multiple mounting methods, quick and easy to install.
- Minimalistic design.
- Focused on residential and high end retail lighting solutions.
- Available in dimming and DALI function.
- Also available in recessed version.
- Adapters incl. driver, DIP switch current selection.

Low Voltage 2 Circuits



48V 2*15A Max.

Low Voltage Single Circuit DALI

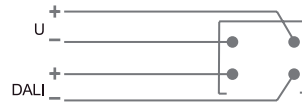

48V 15A Max.



48V SURFACE MOUNTED TRACK SYSTEM

Product Code	EAN	Product description	Colour	Price
PRO-N110-B	8719747934135	1 M track (1000mm)	Black ■	£ 24.90
PRO-N120-B	8719747934142	2 M track (2000mm)	Black ■	£ 45.90
PRO-N130-B	8719747934159	3 M track (3000mm)	Black ■	£ 69.90

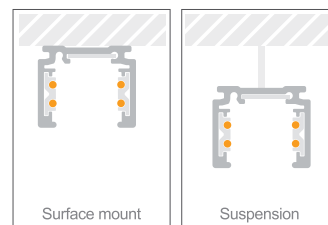
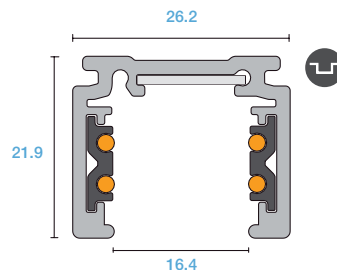

48V RECESSED TRACK SYSTEM

Product Code	EAN	Product description	Colour	Package
PRO-RN110-B	8719747934586	1 M track (1000mm)	Black ■	£ 44.90
PRO-RN120-B	8719747934593	2 M track (2000mm)	Black ■	£ 74.90
PRO-RN130-B	8719747934609	3 M track (3000mm)	Black ■	£ 109.90

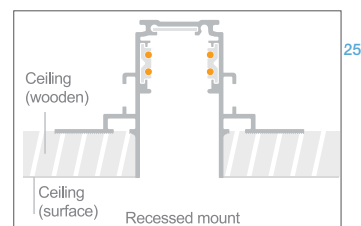
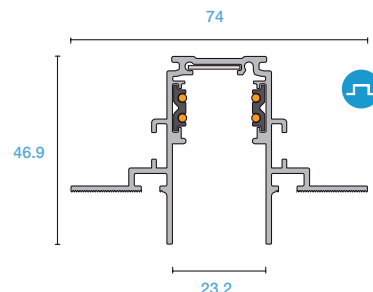

LIVE END CONNECTOR



Product Code	EAN	Colour	Price
PRO-N131-B	8719747934166	Black ■	£ 9.90



RECESSED LIVE END CONNECTOR

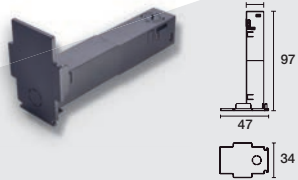

Product Code	EAN	Colour	Price
PRO-RN131-B	8719747934173	Black ■	£ 9.90



END CAP



Product Code	EAN	Colour	Price
PRO-N132-B	8719747934180	Black ■	£ 0.90



RECESSED END CAP

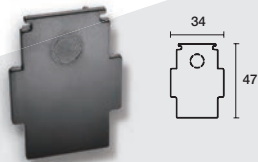

Product Code	EAN	Colour	Price
PRO-RN132-B	8719747934197	Black ■	0.9.90



FLEXIBLE CONNECTOR



Product Code	EAN	Colour	Price
PRO-N139-B	8719747934203	Black ■	£ 19.90



I CONNECTOR



Product Code	EAN	Colour	Price
PRO-N133-B	8719747934210	Black ■	£ 18.50



L CONNECTOR



Product Code	EAN	Colour	Price
PRO-N135-B	8719747934227	Black ■	£ 16.90



L-PROFILE CONNECTOR-FLAT

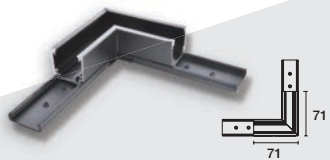

Product Code	EAN	Colour	Price
PRO-N135F-B	8719747934234	Black ■	£ 17.90



L RECESSED PROFILE CONNECTOR-FLAT

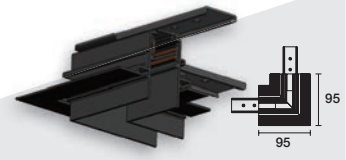

Product Code	EAN	Colour	Price
PRO-RN135F-B	8719747934241	Black ■	£ 22.90



L PROFILE CONNECTOR-STEREO



Product Code	EAN	Colour	Price
PRO-N135S-B	8719747934258	Black ■	£ 18.90



L RECESSED PROFILE CONNECTOR-STEREO

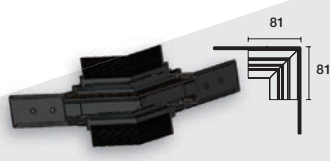

Product Code	EAN	Colour	Price
PRO-RN135S-B	8719747934265	Black ■	£ 25.90



CEILING MOUNT EZ CLICK

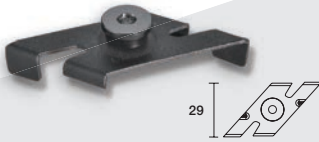

Product Code	EAN	Colour	Price
PRO-N146-B	8719747934319	Black ■	£ 1.90

CEILING MOUNT EZ CLICK WITH ROD

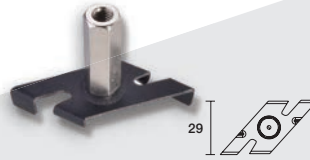

Product Code	EAN	Colour	Price
PRO-EZN147-B	8719747934326	Black ■	£ 7.90

CEILING MOUNT EZ CLICK WITH WIRE

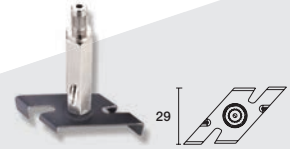

Product Code	EAN	Colour	Price
PRO-EZN148-B	8719747934333	Black ■	£ 9.90

I REINFORCEMENT PLATE



Product Code	EAN	Colour	Price
PRO-N01SK-B	8719747934340	Black ■	£ 3.90

L REINFORCEMENT PLATE



Product Code	EAN	Colour	Price
PRO-N02Sk-B	8719747934357	Black ■	£ 4.90

CEILING MOUNT REINFORCEMENT WITH ROD



Product Code	EAN	Colour	Price
PRO-N147-B	8719747934364	Black ■	£ 9.90

CEILING MOUNT REINFORCEMENT WITH WIRE



Product Code	EAN	Colour	Price
PRO-N148-B	8719747934371	Black ■	£ 10.90

BOLT PLATE



Product Code	EAN	Colour	Price
PRO-N111-B	8719747934388	Black ■	£ 1.90

TRACK COVER STRIP



Product Code	EAN	Colour	Price
PRO-CSN01-B	8719747934395	Black ■	£ 2.90

48V ADAPTER EXCLUDING DRIVER



Product Code	EAN	Colour	Price
PRO-N140A-B	8719747934272	Black ■	£ 12.90

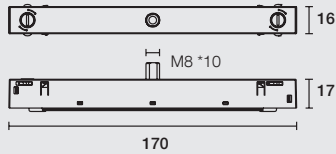

Specifications:
 Mechanical Lock
 Fmax: 10N



48V ADAPTER INCLUDING DRIVER



Product Code	EAN	Colour	Price
PRO-N140A12-B	8719747934289	Black ■	£ 29.90
PRO-N140A28-B	8719747934296	Black ■	£ 30.90
PRO-N140A40-B	8719747934302	Black ■	£ 32.90

Specifications:
 Adapter including LED driver
 Input: 48Vdc
 Output: 8-40V
 Dip-switches for easy output current selection
 Lifetime: 50,000 hours
 Mechanical Lock
 Fmax: 10N

PRO-N140A12	1	2	Power
150mA	○	○	6W
200mA	●	○	8W
250mA	○	●	10W
300mA	●	●	12W

PRO-N140A28	1	2	Power
350mA	○	○	14W
500mA	●	○	20W
700mA	○	●	28W
700mA	●	●	28W

PRO-N140A40	1	2	Power
700mA	○	○	28W
800mA	●	○	32W
900mA	○	●	36W
1000mA	●	●	40W

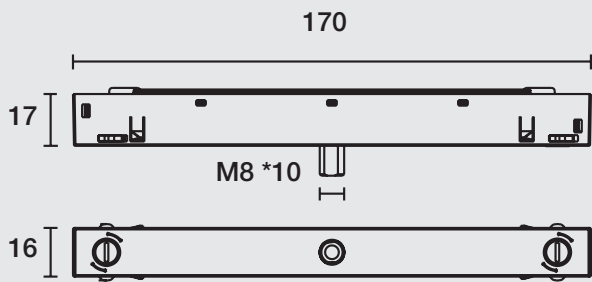

DIP Switch





BEAUTY BAR

ESTÉE LAUDER

ANASTASIA
BEVERLY HILLS

07

ROBUST SINGLE CIRCUIT TRACK SYSTEM

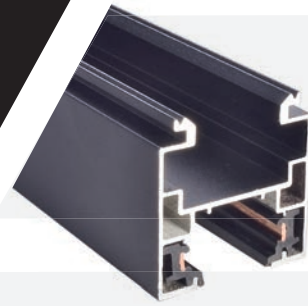

- Single and rugged structure.
- Easy and intuitive installation.
- Compatible with standard track suspension accessories (chapter 04).
- Special compartment for power cable and signal wiring.
- Compatible with 3 wires single circuit adapters (Halo system).
- No length limitation for the track extension.
- Minimize time and material for suspension.

ROBUST SINGLE CIRCUIT SURFACE MOUNTED TRACK SYSTEM

Product Code	EAN	Product description	Colour	Price
PRO-N310-W	8719747934401	1 M track (1000mm)	White <input type="checkbox"/>	£ 19.90
PRO-N310-B	8719747934418	1 M track (1000mm)	Black <input checked="" type="checkbox"/>	£ 19.90
PRO-N320-W	8719747934425	2 M track (2000mm)	White <input type="checkbox"/>	£ 34.90
PRO-N320-B	8719747934432	2 M track (2000mm)	Black <input checked="" type="checkbox"/>	£ 34.90
PRO-N330-W	8719747934449	3 M track (3000mm)	White <input type="checkbox"/>	£ 54.90
PRO-N330-B	8719747934456	3 M track (3000mm)	Black <input checked="" type="checkbox"/>	£ 54.90

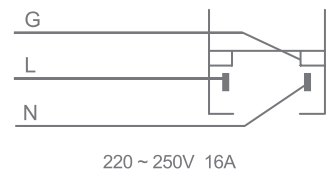
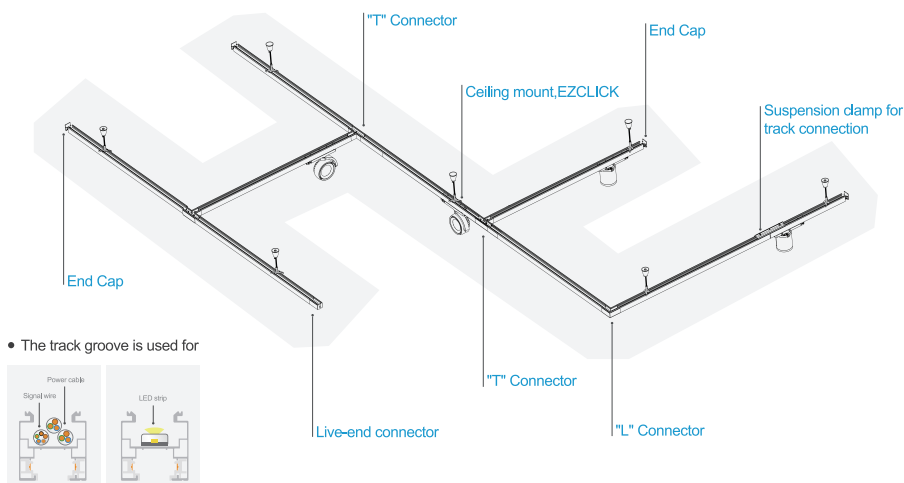
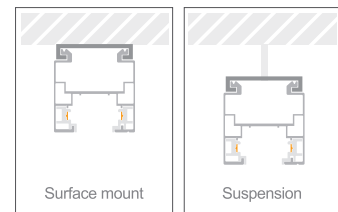
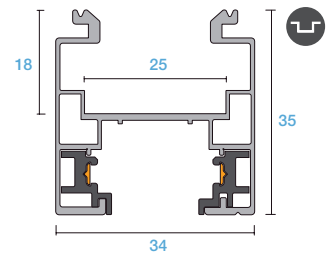

CONNECTION PARTS ROBUST SINGLE CIRCUIT TRACK SYSTEM

LIVE END CONNECTOR



Product Code	EAN	Colour	Price
PRO-N331-W	8719747934487	White <input type="checkbox"/>	£ 5.90
PRO-N331-B	8719747934494	Black <input type="checkbox"/>	£ 5.90



END CAP

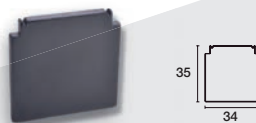

Product Code	EAN	Colour	Price
PRO-N332-W	8719747934463	White <input type="checkbox"/>	£ 0.90
PRO-N332-B	8719747934470	Black <input type="checkbox"/>	£ 0.90



I CONNECTOR

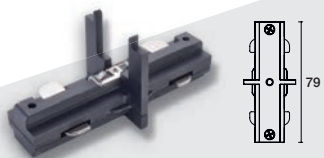

Product Code	EAN	Colour	Price
PRO-N333-W	8719747934500	White <input type="checkbox"/>	£ 3.90
PRO-N333-B	8719747934517	Black <input type="checkbox"/>	£ 3.90



L CONNECTOR



Product Code	EAN	Colour	Price
PRO-N335-W	8719747934524	White <input type="checkbox"/>	£ 9.90
PRO-N335-B	8719747934531	Black <input type="checkbox"/>	£ 9.90



T CONNECTOR



Product Code	EAN	Colour	Price
PRO-N336-W	8719747934548	White <input type="checkbox"/>	£ 14.90
PRO-N336-B	8719747934555	Black <input type="checkbox"/>	£ 14.90



MOUNTING CLAMP

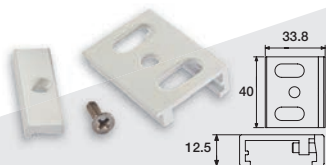

Product Code	EAN	Colour	Price
PRO-04SK-W	8719747930939	White <input type="checkbox"/>	£ 3.00
PRO-04SK-S	8719747930946	Grey <input type="checkbox"/>	£ 3.00
PRO-04SK-B	8719747930953	Black <input type="checkbox"/>	£ 3.00



3 WIRES ADAPTER

halo compatible

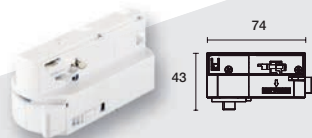

Product Code	EAN	Colour	Price
PRO-A340S-W	8719747934630	White <input type="checkbox"/>	£ 5.90
PRO-A340S-B	8719747932964	Black <input type="checkbox"/>	£ 5.90



3 WIRES ADAPTER

halo compatible



Product Code	EAN	Colour	Price
PRO-0340-W	8719747934654	White <input type="checkbox"/>	£ 2.95
PRO-0340-B	8719747932940	Black <input type="checkbox"/>	£ 2.95





INTALITE UK

Loving Light!

148-154 Merton High St
Wimbledon
London
SW19 1AZ

Tel: +44 (0)20 8542 1471
Fax: 0870 4211 763

sales@intalite.co.uk
www.intalite.co.uk