

TL3700 Series Tubular Locksets

PRODUCT CATALOG



Experience a safer
and more open world

Introduction

TABLE OF CONTENTS

| | |
|--|----|
| Introduction | 2 |
| Functions | 3 |
| Muséo® Trim Designs | 4 |
| Roses | 12 |
| Strikes | 13 |
| How to Order/Quick Codes | 14 |
| How to Order Piet Lever Collection | 15 |
| Finishes, Ordering Example and How to Specify Handling | 16 |
| Architectural Specifications | 17 |

Visit the Decorative Hardware online product selector at selector.corbinruswin.com to mix and match door trim and finishes.

TL3700 SERIES TUBULAR LOCK

Corbin Russwin is pleased to present the TL3700 Series of tubular locks. This series is designed to work with Corbin Russwin Muséo® levers. Engineered for ease of installation with the quality you expect from Corbin Russwin, the TL3700 Series will meet and exceed the expectations of the most demanding architects and design professionals. Ideal interior applications include high-end apartments and condos.

General Information



- For doors 1-3/8" (35mm) to 1-3/4" (44mm) thick standard
- 2-3/4" (70mm) backset standard. Optional: 2-3/8" (60mm); see quick codes; page 14
- Curved lip T-Strike
- Door prep conforms to ANSI/BHMA A156.115
- Latchbolt brass 1/2" (13mm) projection
- Specify hand of lock on order; easily field reversible
- UL-cUL - Fire listing is optional and must be specified for A label and lesser class doors, 4' (122cm) x 10' (305cm) single or 8' (244cm) x 10' (305cm) pair. Letter F and UL symbol on armored front indicate listing.
- One-year limited warranty



WARNING

This product can expose you to lead which is known to the state of California to cause cancer and birth defects or other reproductive harm. For more information go to www.P65warnings.ca.gov.

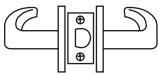
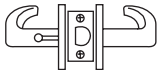
Functions

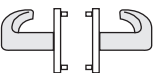
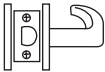
| Illustration | Series/Function | Type | Description |
|---|-------------------|---------------------------------------|--|
|  | TL3710 TL3710A | Passage Passage 3 hour | <ul style="list-style-type: none"> • Both levers retract latch • Ideal for closets & bedrooms |
|  | TL3720 TL3720A | Privacy Privacy 3 hour | <ul style="list-style-type: none"> • Inside lever always retracts latch • Outside lever retracts latch, except when locked by inside push button • Closing door unlocks outside lever • Includes emergency release • Ideal for bathrooms & home offices |
|  | TL3750 | Half Dummy Trim-Through Bolted | <ul style="list-style-type: none"> • Lever always rigid • No latch included • Ideal for pantries & closets <p>Note: Handing for dummy trim only depends on side of door lever trim installed, see page 16.</p> |
|  | TL3750S | Half Dummy Trim-Surface Mounted | <ul style="list-style-type: none"> • Lever always rigid • No latch included • Ideal for pantries & closets <p>Note: Handing of door for dummy trim only depends on side of door lever trim installed.</p> |
|  | TL3770 | Full Dummy Trim-Through Bolted | <ul style="list-style-type: none"> • Levers always rigid • No latch included • Ideal for sliding doors <p>Note: Handing for dummy trim only depends on side of door lever trim installed, see page 16.</p> |
|  | TL3780 TL3780A | Communicating Communicating 3 hour | <ul style="list-style-type: none"> • Blank rose outside • Lever retracts latch • Ideal for adjoining rooms <p>Note: Hand door from outside of door.</p> |

Muséo® Trim Designs

JACKSON

Intuitive shapes, moving with the energetic rhythm of modern life.



| | | |
|--|--|--|
| | <p>105² Lever: Cast Non-Handed lever</p> | |
| | <p>117² Lever: Cast Non-Handed lever</p> | |
| | <p>119² Lever: Cast Handed - Specify hand Non-Reversible</p> | |
| | <p>121² Lever: Cast Handed - Specify hand Non-Reversible</p> | |
| | <p>126^{1,2} Lever: Cast Non-Handed lever</p> | |
| | <p>152 Lever: Cast Non-Handed lever</p> | |

1. Complies with codes requiring lever to return to within 1/2" (13mm) of door face.
2. Not available in 629 or 630 finish.

Muséo® Trim Designs

SALVADOR

Dreamlike beauty manifested in solid, familiar forms.



| | | |
|--|--|--|
| | <p>106 Lever: Cast Non-handed lever</p> | |
| | <p>107 Lever: Cast Non-handed lever</p> | |
| | <p>108 Lever: Cast Non-handed lever</p> | |
| | <p>109¹ Lever: Cast Non-Handed lever</p> | |
| | <p>110 Lever: Cast Non-handed lever</p> | |
| | <p>123¹ Lever: Cast Non-handed lever</p> | |
| | <p>128¹ Lever: Cast Non-handed lever</p> | |











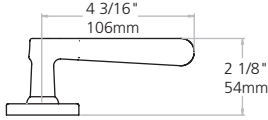

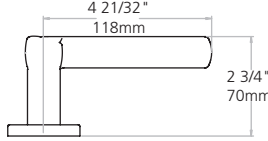
1. Complies with codes requiring lever to return to within 1/2" (13mm) of door face.

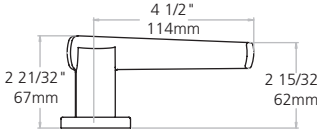
Muséo® Trim Designs

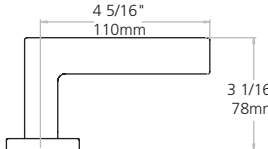
MARC

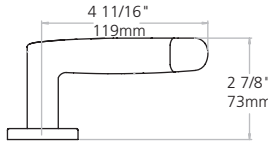
Fluid lyricism expressed through whimsical lines and dynamic contours.

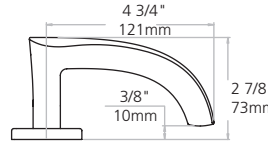

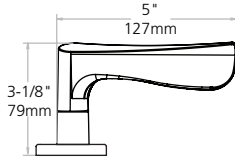
| | | |
|---|--|---|
|  | <p>111² Lever: Cast Handed - Specify hand Non-Reversible</p> |  |
|  | <p>112² Lever: Cast Handed - Specify hand Non-Reversible</p> |  |
|  | <p>114² Lever: Cast Handed - Specify hand Non-Reversible</p> |  |
|  | <p>115² Lever: Cast Handed - Specify hand Non-Reversible</p> |  |
|  | <p>116² Lever: Cast Handed - Specify hand Non-Reversible</p> |  |
|  | <p>131^{1,2} Lever: Cast Handed - Specify hand Non-Reversible</p> |  |
|  | <p>151 Lever: Cast Handed - Specify hand Non-Reversible</p> |  |

1. Complies with codes requiring lever to return to within 1/2" (13mm) of door face.
2. Not available in 629 or 630 finish.

Muséo® Trim Designs

GEORGIA

Timeless elegance in forms inspired by the natural world.



| | | |
|--|--|--|
| | <p>102 Lever: Cast Non-Handed lever</p> | |
| | <p>103 Lever: Cast Non-Handed lever</p> | |
| | <p>104² Lever: Cast Non-Handed lever</p> | |
| | <p>124¹ Lever: Cast Non-Handed lever</p> | |
| | <p>125¹ Lever: Cast Non-Handed lever</p> | |

1. Complies with codes requiring lever to return to within 1/2" (13mm) of door face.
2. Not available in 629 or 630 finish.

Muséo® Trim Designs

LASZLO

Fine art meets function through crafted lines and flowing curves.



147
Lever: Cast
Non-Handed lever

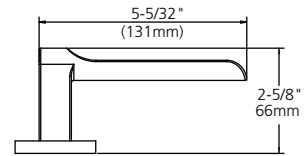

148¹
Lever: Cast
Non-Handed lever

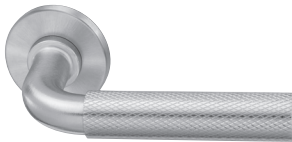
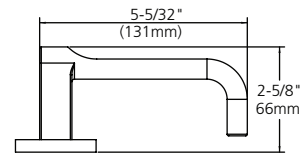

149
Lever: Cast
Non-Handed lever

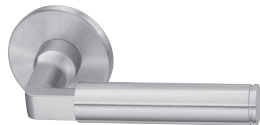
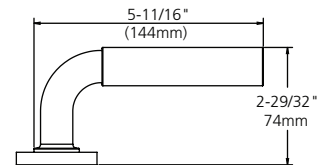

150
Lever: Cast
Non-Handed lever

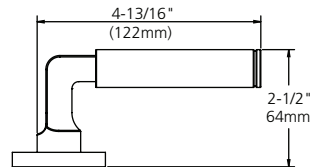

1. Complies with codes requiring lever to return to within 1/2" (13mm) of door face.

Muséo® Trim Designs

JOSEF

Tribute to the square with beautifully simple, but equally dramatic forms.



| | | |
|--|--|--|
| | <p>133 Lever: Cast Non-Handed lever</p> | |
| | <p>134¹ Lever: Cast Non-Handed lever</p> | |
| | <p>135² Lever: Cast Non-Handed lever</p> | |
| | <p>136² Lever: Cast Non-Handed lever</p> | |
| | <p>137^{1,2} Lever: Cast Non-Handed lever</p> | |
| | <p>138^{1,2} Lever: Cast Non-Handed lever</p> | |

1. Complies with codes requiring lever to return to within 1/2" (13mm) of door face.
2. 135-138 contain white or back polycarbonate insert

Muséo® Trim Designs

GEORGES

Enduring, contemporary pieces that evoke an emotional response with sophisticated design.



139
Lever: Cast
Non-Handed lever

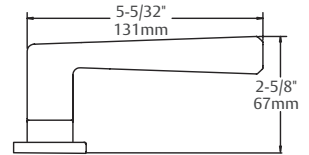

140¹
Lever: Cast
Handed lever

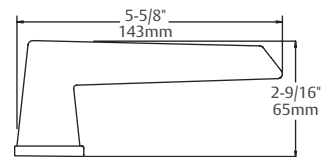

143¹
Lever: Cast
Non-Handed lever

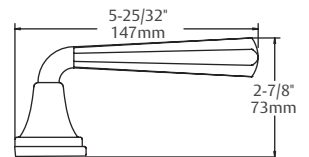

1. Not available with TL3720 or TL3720A

Muséo® Trim Designs

PIET

Striking levers with sleek, clean lines.

***Refer to page 15 for how to order the Piet Lever Collection.**



21G
Grooved Insert
Lever: Stainless steel
Non-Handed Lever

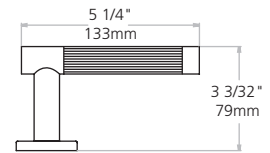

21L
Leather Insert
Lever: Stainless steel
Non-Handed Lever

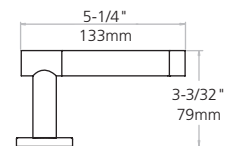

21M
Polished with Satin Insert
Lever: Stainless steel
Non-Handed Lever

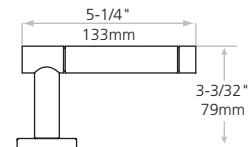

21S
Santoprene™ Insert
Lever: Stainless steel
Non-Handed Lever

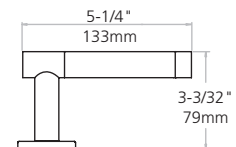

23M
With Raised Band
Lever: Stainless steel
Non-Handed Lever

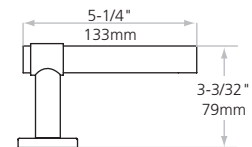

25M
Plain
Lever: Stainless steel
Non-Handed Lever

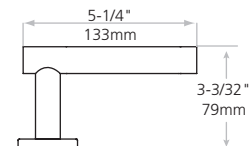

27M
Plain with Two Grooves
Lever: Stainless steel
Non-Handed Lever

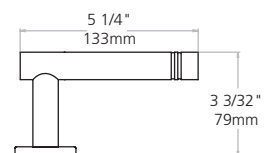

Muséo® Trim Designs

MUSÉO ROSES

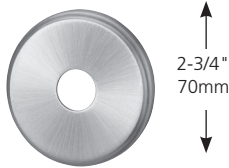

V Rose

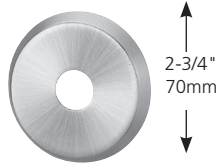

U Rose

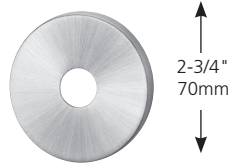

T Rose

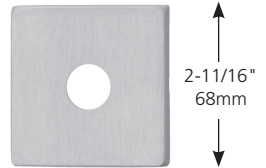

E2 Rose¹

Strikes

Curved Lip "T" Strike (standard)

- Brass
- 2-3/4" x 1-1/8" x 1-1/4" lip to center
- Optional lip lengths: 1", 1-1/8", 1-3/8", 1-1/2", 1-3/4", 2", 2-1/4", 2-1/2", 2-3/4", 3"
- To order separately, specify 586L19 x Lip Length x Finish

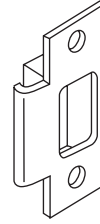

ANSI Curved Lip

- Brass or stainless steel
- 4-7/8" x 1-1/4" x 1-1/4" lip to center
- Optional lip lengths: 1", 1-1/8", 1-3/8", 1-1/2", 1-3/4", 2", 2-1/4", 2-1/2", 2-3/4", 3"
- To order separately, specify 217L13 x Lip Length x Finish
- To order with lockset, specify quick code found on page 14

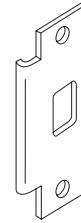

Full Lip Strike

- Brass or stainless steel
- 2-1/4" x 1-3/4" x 1-1/4" lip to center
- No optional lip lengths
- To order with lockset, specify quick code found on page 14
- To order separately specify 680L50M020 x Finish
- Anti-rattle tab

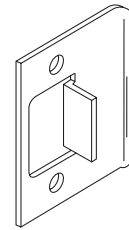

Full Lip Strike – 1/4" Radius Corners

- Brass or stainless steel
- Similar in dimension and function to L50 strike (above) but with radius corners for easy mortising by power tools
- To order with lockset, specify quick code found on page 14
- To order separately specify 680L51M020 x Finish
- Anti-rattle tab

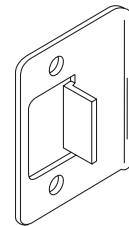

ANSI Wrought Strike Box

- To order with lockset, specify quick code found on page 14. To order separately, specify 120F768.

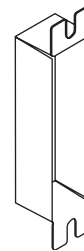

1. Cannot retrofit on existing cylindrical lock door preps with thru-bolt holes outside the 2-1/8" bored hole.

How to Order/Quick Codes

STRIKES

| Lip to Center | ANSI Curved Lip, Specify | T-Strike Curved Lip Box, Specify | Full Lip Specify | Full Lip Radius Corner Specify |
|---------------|--------------------------|----------------------------------|------------------|--------------------------------|
| 1" (25mm) | SA100 | SC100 | N/A | N/A |
| 1-1/8" (29mm) | SA118 | SC118 | N/A | N/A |
| 1-1/4" (32mm) | SA114 | SC114 (std) | SF114 | SFR114 |
| 1-3/8" (35mm) | SA138 | SC138 | N/A | N/A |
| 1-1/2" (38mm) | SA112 | SC112* | N/A | N/A |
| 1-3/4" (44mm) | SA134 | SC134 | N/A | N/A |
| 2" (51mm) | SA200 | SC200 | N/A | N/A |
| 2-1/4" (57mm) | SA214 | SC214 | N/A | N/A |
| 2-1/2" (28mm) | SA212 | SC212 | N/A | N/A |
| 2-3/4" (70mm) | SA234 | SC234 | N/A | N/A |
| 3" (76mm) | SA300 | SC300 | N/A | N/A |

*Standard for D214

MICELLANEOUS OPTIONS

| Description | Specify |
|--|---------|
| Rounded corners on latch front | M13 |
| 1" (25mm) latch front, square corners | M14** |
| 1" (25mm) latch front, rounded corners | M15 |
| ANSI wrought strike box | M17 |

**Standard for 2-3/8" backset

DOOR THICKNESS

| Measurement | Specify |
|---------------------------------------|------------|
| 1-3/8" (35mm) up to 1-3/4" (44mm) | D138 |
| 1-3/4" (44mm) up to 2" (51mm) | (standard) |
| 2" (51mm) up to 2-1/2" (64mm) | D214 |
| Consult factory if over 2-1/2" (64mm) | |

BACKSET

| Measurement | Specify |
|-----------------------------|------------|
| 2-3/4" (70mm) | (standard) |
| 2-3/8" (60mm) | B238† |
| †1" front supplied standard | |

How to Order Piet Lever Collection

LEVER TRIM AND FINISH OPTIONS



PIET FINISH CODES

| ANSI/BHMA & Corbin Russwin Finish Code | Piet Code* | Description |
|--|------------|---------------------------------------|
| 630 | 30 | Satin Stainless Steel |
| 629 | 29 | Bright Stainless Steel |
| N/A | BK | Black (Santoprene™ or leather insert) |
| N/A | BN | Brown (leather insert) |
| N/A | 00 | No Insert |
| 613E | E3 | Dark Satin Bronze Equivalent |
| BSP | BS | Black Suede |
| WSP | WS | White Suede |

*Code used to specify Piet Collection finishes only. Use available finishes list to specify desired finish when ordering.

PIET LEVER DESCRIPTIONS & AVAILABLE FINISHES

| Lever Designation | Lever Description | Available Finishes (as ordered) |
|-------------------|-------------------|--|
| 21G | Grooved Insert | 303030, 292929, 293029, 302930, 3E003E, BP00BP, WS00WS |
| 21L | Leather Insert | 30BK30, 30BN30, 29BK29, 29BN29, 3EBK3E, BSBKBS, WSBKWS, 3EBN3E, BSNBNS, WSNBNS |
| 21M | Metallic Insert | 293029** |
| 21S | Santoprene Insert | 30BK30, 29BK29, 3E003E, BS00BS, WS00WS |
| 23M | Raised Band | 290030**, 290029, 300030, 300029***, 3E003E, BS00BS, WS00WS |
| 25M | Plain | 290029, 300030, 3E003E, BS00BS, WS00WS |
| 27M | Two Grooves | 290029, 300030, 3E003E, BS00BS, WS00WS |

**Two-tone finish - grip of lever is 630, balance of lever is 629. Rose and lock finish will be 629.

***Two-tone finish - grip of lever is 629, balance of lever is 630. Rose and lock finish will be 630.

ORDERING EXAMPLES

Rose Options: T, U, V, E2

| Quantity | Series/ Function | Trim | Lever Finish | Lock Finish | Hand |
|----------|------------------|------|--------------|-------------|------|
| 2 | TL3710 | 21LU | 29BK29 | 629 | RH |
| 5 | TL3710 | 25MT | 290029 | 629 | RH |

Finishes, Ordering Example and How to Specify Handing

FINISHES

| Description | | Specify |
|----------------|--|---------|
| ANSI/BHMA 605 | Bright Brass | 605 |
| ANSI/BHMA 606 | Satin Brass | 606 |
| ANSI/BHMA 611 | Bright Bronze | 611 |
| ANSI/BHMA 612 | Satin Bronze | 612 |
| ANSI/BHMA 613 | Dark Oxidized Satin Bronze, Oil Rubbed | 613 |
| 613E | Dark Oxidized Satin Bronze - equivalent | 613E |
| ANSI/BHMA 613L | Dark Oxidized Satin Bronze, Clear Coated | 613L |
| ANSI/BHMA 618 | Bright Nickel Plated | 618 |
| ANSI/BHMA 619 | Satin Nickel Plated | 619 |
| ANSI/BHMA 625 | Bright Chromium Plated | 625 |
| ANSI/BHMA 626 | Satin Chromium Plated | 626 |
| ANSI/BHMA 629 | Bright Stainless Steel | 629 |
| ANSI/BHMA 630 | Satin Stainless Steel | 630 |
| ANSI/BHMA 722 | Black Oxidized Bronze, Oil Rubbed | 722 |
| — | Black Suede Powder Coat | BSP |
| — | White Suede Powder Coat | WSP |

NOTE: See page 15 for available finishes for Piet levers.

ORDERING EXAMPLE

TL3700 Series

| Quantity | Series/Function | Trim | Finish | Hand* |
|----------|-----------------|------|--------|-------|
| 25 | TL3710 | 102U | 626 | RH |

HOW TO SPECIFY HANDING

Door hands determined from outside (secure side) of door.

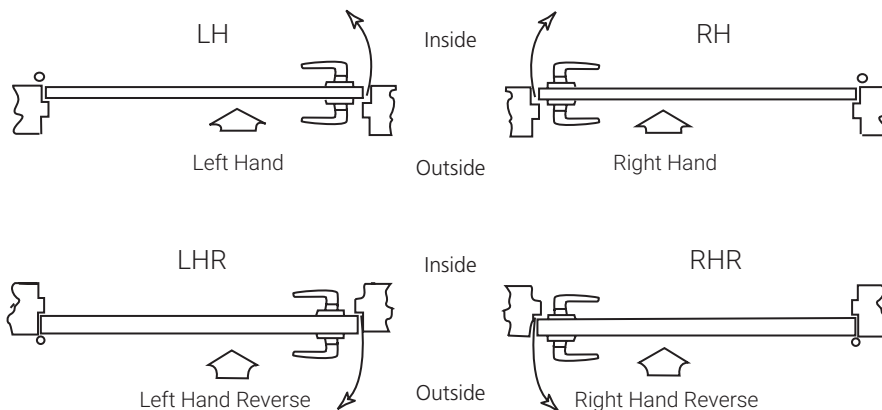

*When ordering single dummy trim with handed levers:

Order the hand to match the hinge location on the same side of the door where the trim will be installed.

- When viewing trim side and hinges are on the right, order **Right Hand**
- When viewing trim side and hinges are on the left, order **Left Hand**.

Architectural Specifications

TL3700 SERIES TUBULAR LOCK

1. Locksets shall be TL3700 Series as manufactured by Corbin Russwin Architectural Hardware, Berlin, CT.
2. Locks shall be field reversible for handing with bi-directional lever operation.
3. Locks shall mount in a standard ANSI/BHMA door prep (2-1/8" dia.) without additional throughbolt preps.
4. Lockset levers shall be made of solid material with no plastic fillers.
5. Locks shall have a 2-3/4" (70mm) backset standard, with 2-3/8" (60mm) offered as an option.
6. Strikes shall be non-handed with a curved lip.
7. Locks shall have a one year limited warranty.

EXPLODED VIEW

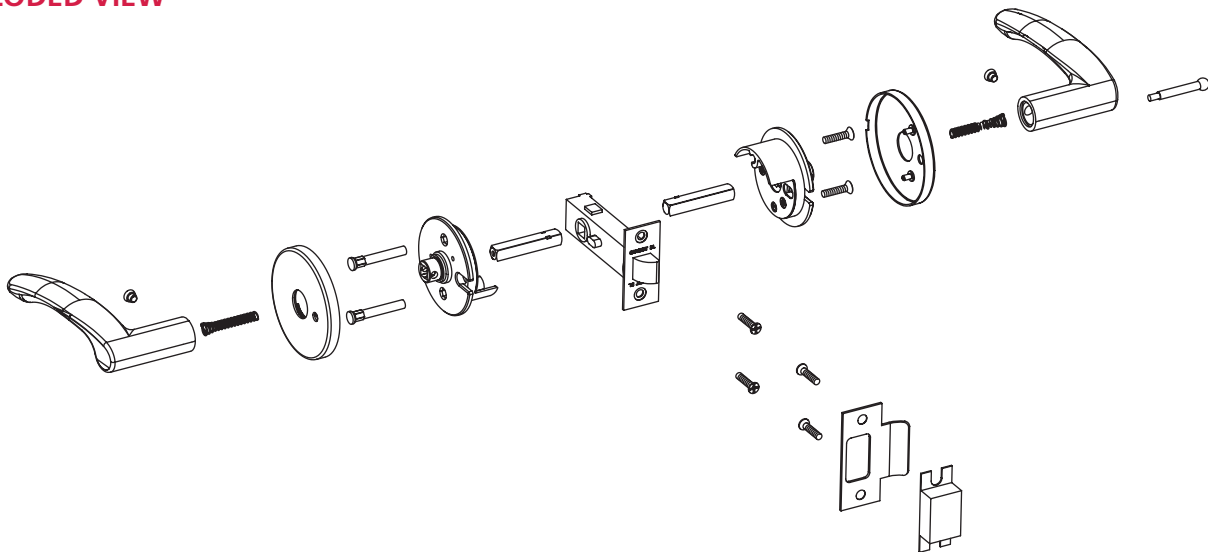

The ASSA ABLOY Group is the global leader in access solutions. Every day, we help billions of people experience a more open world.

ASSA ABLOY Opening Solutions leads the development within door openings and products for access solutions in homes, businesses and institutions. Our offering includes doors, frames, door and window hardware, locks, perimeter fencing, access control and service.



For additional information, contact your
ASSA ABLOY Door Security Solutions
sales consultant or
visit www.corbinruswin.com.

In U.S.

Corbin Russwin
Architectural Hardware
225 Episcopal Road
Berlin, CT 06037
Phone: 800-543-3658
Fax: 800-447-6714
www.corbinruswin.com

In Canada

ASSA ABLOY Door
Security Solutions Canada
160 Four Valley Drive
Vaughan, Ontario
Canada L4K 4T9
Phone: 800-461-3007
Fax: 800-461-8989
www.assaabloydss.ca