

SARGENT®

ASSA ABLOY

TurboShip



Experience a safer
and more open world

Table of Contents

TurboShip

SARGENT

ASSA ABLOY

www.sargentlock.com



General Information	3	Exit Devices	38-56
TurboKey Information	4	80 Series	38-45
Cylinders/Keys	5-10	8900 Series with Trim	38
Parts	6-9	8800 Series Device Only	39
Degree Parts	10-11	8800 Series with Trim	40
Keyblanks	12	8800 Series Trim Only	41
Degree Keyblanks	13	8700 Series	42
Bored Locks	14-23	8600 Series	43
11 Line	14	8500 Series	44
10X Line	15	8400 Series	45
10X Line with VSL Indicator Trim	16	90 Series	46
7 Line	17	30 Series	47-48
6500 Line	18	5300 Series Alarm Hardware	49-50
8X Line	19	7000 Series Multipoint Lock	51
HP ALP Trim	20	Parts	52-55
DL Series	21	Auxiliary Locks	56-60
Parts	22	4870 Series Mortise Deadbolt	56
Mortise Locks	23-30	460 & 480 Series Cylindrical Deadbolt	57
8200 Series	23	758 & 858 Series Padlock	58
Status Indicator Upgrade Kits	24	Parts	59
8200 Series with BHW Trim	25	Access Control	60-61
8200 Series with ALP Trim	26	Keypad Operated Products	60
8200 Series Lockbody Only	27	Electromechanical Parts and Accessories	61
Parts and Accessories	28	Order Forms	62-69
Door Control	29-35	Cylinders/Keys	62
281 Series	29	Turbo-Key	63
351 Series	30	Bored Locks	64
1431 Series	31	Mortise Locks	65
1331 Series	32	Exit Devices	66
1131 Series	33	Auxiliary Locks	67
422 Series	34	Access Control	68
Overhead Holders & Stops	35		
Parts	36-37		

 **WARNING**

This product can expose you to lead which is known to the state of California to cause cancer and birth defects or other reproductive harm. For more information go to www.P65warnings.ca.gov.

General Information

TurboShip

Program Guidelines

- Only products listed in this brochure are available on Turbo. Products not listed in this brochure will automatically be entered at standard factory production lead times
- Please refer to the SARGENT Price Book for product pricing information
- Cylinders are packed separately within the product box
- The TurboKeyway is LA, furnished with nickel silver keys, for all products requiring a keyed function
- Standard Keying - 1-BITTED (111111) keying with LA Keyway. If Keyed Different is desired, specify KD(LA)
- Electrified products offered are available in 12VDC or 24VDC
- The #34 rim and #41, #42, #47-41-101 mortise cylinders are available in LA keyway only

24-Hour

- Orders received prior to 1pm EST will ship within 24 hours
- Quote pricing cannot be used on 24 hr TurboShip orders
- Standard Buying Program discounts less 10% are automatically applied
- Electrified products – Maximum 50 locks per order
- Orders cannot be changed or cancelled

1-Week

- Orders received prior to 4:30 EST will ship within 5 working days
- Standard Buying Program discounts apply
- Project quote discount less 5% is automatically applied
- Orders can be changed or cancelled within 24 hrs of receipt without a fee, if manufacture of product has not started
- If product has been started, orders changed or cancelled will incur a 45% fee
- The change/cancellation fee will be billed on the Customer's original order

2-Week

- Orders received prior to 4:30 EST will ship within 10 working days
- Standard Buying Program discount or project quote discounts are applicable
- Limited to \$50,000 net/net orders
- Orders changed or cancelled 3 days after receipt of order will affect the shipping date and will result in a charge of cost for materials and incurred labor
- If the product has been made, a 45% fee will apply
- The change/cancellation fee will be billed on the Customer's original order

Shipments

- All shipments are made F.O.B. factory. Shipments may be subject to small parcel handling charges and fuel surcharges as part of the freight.
- Shipping charges are prepaid and will be added to your invoice
- UPS Ground is the standard freight carrier

Returns

- Refer to the SARGENT Price Book for the policy on returned goods.

How To Order

1. Please use a separate Order Form for each Turbo Program used, Turbo - 24 -hour, 1-Week, 2-Week, or TurboKey.
2. This catalog contains one Order Form. Copy Order Forms from this catalog as needed.
Note: The Order Form is your Purchase Order – Do not send a cover sheet. If your order is duplicated, it cannot be returned.
3. You may fax the preprinted SARGENT Turbo Program to 1-800-906-6606 or email to turboorders.sargent@assaabloy.com.
4. If you use your own purchase order forms instead of the pre-printed SARGENT form, please supply the information in the proper SARGENT nomenclature so your order can be processed without delay:

Ordering Example

Quantity	Options	Product	Trim	Finish	Hand	Rail Size
5	12	8813	ETJ	32D	RHR	G

*All orders must have complete information for processing.

Please reference the SARGENT price book for specifics about freight and special shipping requests.

General Information

1. TurboKey orders for simple Masterkeyed jobs & existing conventional cylinder systems that were developed after 1997, received prior to 3 PM EST will be scheduled to ship 8 working days after receipt of order.
2. TurboKey orders for simple Masterkeyed jobs are available in SARGENT LA Keyway only.
3. TurboKey orders are available in conventional 6 pin cylinders only, Prefixes are not available.
4. Buying Program discount is automatically applied. No additional discount may be applied.
5. TurboKey orders cannot be changed or cancelled.

Program Guidelines

- All products available on 1 week Turbo are available on TurboKey. Products not listed in this brochure will be entered at standard factory lead times.
- TurboKey orders for existing conventional cylinder systems that were developed after 1997 are available in all SARGENT keyways except single keyway sections R, S, U and CR, along with C Keyway
- Orders must be received on the provided TurboKey forms
- NO changes or cancellations will be allowed
- Only keysets can be stamped on keys. Stamping of phrases like "DO NOT DUPLICATE," for example, is not offered.
- 2 keys per cylinder will be provided. NO Exceptions
- One Masterkey system per order
- 6 masterkeys will be provided with each order
- NO door schedules or key schedules will be accepted as orders
- NO cross-keying
- No Degree, Keso F1, KESO, XC, Signature, 5100/6300 LFIC (Removable) Cores, or Best I.C.
- Additions to existing TurboKey generated systems. Please note that these orders DO NOT go through keying review. Keysets will be furnished as ordered. Please refer to the bitting list that was provided with the original order for keyset information
- Key Registration number must be furnished with order number

Simple Masterkey System Guidelines

- All General Guidelines apply as noted above
- LA Keyway ONLY
- Simple level 2 Masterkey systems only
- Construction keying 21 option (lost ball) available
- Maximum of 150 keyed cylinders per order; Maximum of 50 keyed cylinders per order for existing systems
- 3 construction keys will be provided on 21 option construction key systems
- For new Masterkey systems or additions to TurboKey generated systems only. Expanded bitting lists will be provided to the distributor on every order. Orders with less than 40 changes, expansion will be 60 total. Orders with greater than 40 changes, expansion will be 256 changes.
- For NEW masterkey systems or TurboKey generated systems or TurboKey generated systems ONLY.
- TurboKey system numbers begin with LT

How to Order

1. Orders must be received on the Order Forms provided and specified as a TurboKey Program Order.
2. Please do not combine with any other orders.
3. Order Forms are your Purchase Orders – Do not send a cover sheet. If your order is duplicated, it cannot be returned.
4. You may fax the preprinted SARGENT Turbo Program order forms to 1-800-906-6606 or email to turboorders.sargent@assaabloy.com.

Returns

- Refer to the SARGENT Price Book for the policy on returned goods

Cylinders

Bored Lock & Mortise Lock Cylinders

Cylinders and keys provide the right level of control with a full range of options.

Cylinders / Keys

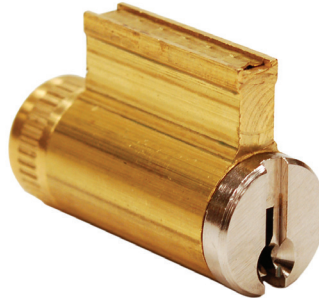

Bored Lock Cylinders

Program	Options	Cylinder Type	Finishes
1-Week & 2-Week	KD	C10-1 C10X-1	04, 15

Mortise Cylinders

Program	Options	Cylinder Type	Finishes
24-Hour	KD, SC*, 60**	34 41	32D
1-Week & 2-Week		34 41 42 41-101	03, 04, 10, 10B, 10BE, 32, & 32D

Options

- KD Keyed Different
- SC Schlage "C" Keyway
- 60 Disposable Construction Core

Finishes

- 03 Bright Brass
- 04 Dull Brass
- 10 Satin Bronze
- 10B Oxidized Satin Bronze
- 10BE Dark Oxidized Satin Bronze - Equivalent
- 15 Satin Nickel
- 32 Bright Stainless Steel
- 32D Satin Stainless Steel

Cylinder Types

- 34 Rim Cylinder
- 41 Mortise Cylinder (1-1/8")
- 42 Mortise Cylinder (1-1/4")
- 41-101 Mortise Cylinder with 101 Cam (13-0512) - (Adams Rite 1850 & 4700)
- 42-101 Mortise Cylinder with 101 Cam (13-0512) - (Adams Rite 1850 & 4700)
- C10-1 10, 7, 6500 Line Cylinder
- C10X-1 10X Line Cylinder

* Not available with 42 cylinder

** Not available with 41 cylinder

Cylinders

Parts

Cylinders /
Keys

Program	Part #	Description	Cylinder/ Product	Finish	Keyways	Restricted Keyways
1-Week & 2-Week	13-2005	Body & Slide Assembly	34 & 41	03, 04, 10, 10B, 26, 26D, 32, 32D	N/A	N/A
	13-0664	Standard Cam	41	N/A		
	01-1121	Cam Screws				
	13-0512 (101)	Adams Rite Cam				
	13-1341	Slide*	34 & 41, 480 Line, 6 Line, 6500 Line, 7 Line, 10 Line, 10X Line, 11 Line			
	13-0086	Cylinder Back Plate	34			
	13-0085	Rim Tail Piece				
	13-0074	Standard Connecting Screws				
	13-0080	Plug Retainer				
	13-3257	Body & Slide Assembly	6 Line, 6500 Line, 7 Line, 10 Line, 10X Line, 11 Line			
	13-0908	Tail Piece	6 Line			
	13-0205	Plug Retainer	6 Line, 6500 Line, 7 Line, 10 Line, 10X Line, 11 Line			
	13-0401	Plug	41	04, 15	LA, LB, LC, LE, LF, LG, LJ, LK, LL, RA, RB, RC, RE, RF, RG, RJ, RK, RL	AA, AB, AC, AE, AF, AG, AJ, AK, AL, BA, BB, BC, -GA, GB, GC, GE, GF, GG, GJ, GK, GL, KA, KB, KC, KE, KF, KG, KJ, KK, KL, VA, VB, VC, VE, VF, VG, VJ, VK, VL, NA, NB, NC, NE, NF, NG, NJ, NK, NL
	13-0090		34			
6251 CMK	Temporary Construction Removeable Core Master Key	11, 10X, 10, 7, & 6500 Line	N/A	N/A	N/A	
6251 CTL	Temporary Construction Removeable Core Control Key					
6400	Construction Core					04
65-6300	Unassembled Core					04, 15

* Used for cylinders manufactured after June 2009 (Sold in sets of 100 units)

Cylinders

Parts

Cylinders /
Keys

Program	Part #	Description	Cylinder/ Product	Finish	Keyways	Restricted Keyways	
1-Week & 2-Week	13-3425	Plug	7 Line, 8 Line, 8X Line	04, 15	LA, LB, LC, LE, LF, LG, LJ, LK, LL, RA, RB, RC, RE, RF, RG, RJ, RK, RL	AA, AB, AC, AE, AF, AG, AJ, AK, AL, BA, BB, BC, GA, GB, GC, GE, GF, GG, GJ, GK, GL, KA, KB, KC, KE, KF, KG, KJ, KK, KL, VA, VB, VC, VE, VG, VG, VJ, VK, VL, NA, NB, NC, NE, NF, NG, NJ, NK, NL	
	13-0874	Plug	470, 480 7500				
	13-3142	Plug w/ Retainer	6 Line, 6500 Line, 7 Line, 10 Line, 10X Line, 11 Line				
	06-0166	Plug w/ Retainer	7,8,9 knobs (prior to March 2005)	N/A	N/A	N/A	
	13-0895	Tail Piece	6500 Line, 7 Line, 10 Line	N/A	N/A	N/A	
	13-1385		11 Line				
	10-3629	Tail Piece Pack (used with mechanical functions)		10X Line			
	10-3791	Tail Piece Pack (used with electrified functions)		10X Line			
	13-0878	Tail Piece	464, 474,484				
	13-0880		465, 485, 487				
	13-0881		475, 486				
	13-0882	Tail Washer	484				
	13-0883		464, 465, 485, 486, 487				
	13-0680	Tail Piece Retainer		6500 Line, 7 Line, 10 Line, 10X Line, 11 Line			
	13-0875	Cap		480 Line			
	13-1554	Cap Pin	480 Line - Effective 6/03				
	13-0691						
	13-1555		Cap Spring				
	13-0693	Cap Spring	480 Line - Prior to 6/03				
	13-2048		Body & Slide Assembly	8 and 9 knobs			
	13-3493	Body & Slide Assembly		460 Line, 470 Line, 480 Line			
	13-0884	Blocking Piece		460, 470, 480			

* Discontinued product

** Used for Cylinders manufactured after June 2008 (sold in sets of 100 units)

Cylinders

Parts

Cylinders /
Keys

10 Line & 7 Line Interchangeable Core Tail Pieces

Program	Part #	Description	Cylinder/ Product
1-Week & 2-Week	10-3429	LFIC XC LFIC Degree	11-6300, DGX-6300
	10-0239	LFIC Conventional LFIC Signature	6300, 10-6300
	10-0239	SFIC 6 Pin	7300B
	10-0286	SFIC 6 Pin	7300B
	10-0240	SFIC 7 Pin	7P-7300B
	10-3138	SFIC XC	11-7P-7300B

10X Line Interchangeable Core Tail Pieces

Program	Part #	Description	Cylinder/ Product
1-Week & 2-Week	10-3631	LFIC Conventional LFIC Signature & LFIC Degree (used with mechanical functions)	6300, 10-6300, DGX-6300
	10-3773	LFIC Conventional LFIC Signature & LFIC Degree (used with electrified functions)	6300, 10-6300, DGX-6300
	10-3635	LFIC XC (used with mechanical functions)	11-6300
	10-3777	LFIC XC (used with electrified functions)	11-6300
	10-3633	SFIC 6 Pin (used with mechanical functions)	7300B
	10-3775	SFIC 6 Pin (used with electrified functions)	7300B
	10-3641	SFIC 7 Pin SFIC XC (used with mechanical functions)	7P-7300B, 11-7P-7300B
	10-3779	SFIC 7 Pin SFIC XC (used with electrified functions)	7P-7300B, 11-7P-7300B

11 Line Interchangeable Core Tail Pieces

Program	Part #	Description	Cylinder/ Product
1-Week & 2-Week	11-0172	LFIC Conventional LFIC Signature	6300, 10-6300
	11-5003	LFIC XC & LFIC Degree	11-6300, DGX-6300
	11-0171	SFIC	7300B
	11-0172	SFIC 7 Pin	7P-7300B
	11-0276	SFIC XC	11-7P-7300B

Cylinders

Parts

Program	Tool #	Description
1-Week & 2-Week	436-1	Slide Block Kit
	432RC	LFIC Installation Tool
	432IC	SFIC Installation Tool
	13-0064 Size 1 13-0065 Size 2 13-0066 Size 3 13-0067 Size 4 13-0068 Size 5 13-0069 Size 6 13-0070 Size 7 13-0071 Size 8 13-0072 Size 9 13-0073 Size 10 13-0061 Size 12 13-0062 Size 13 13-0063 Size 14	Bottom Pins
	13-0051 Size 2 13-0052 Size 3 13-0053 Size 4 13-0054 Size 5 13-0055 Size 6 13-0056 Size 7 13-0057 Size 8 13-0058 Size 9 13-0059 Size 10 13-0060 Size 11 13-0061 Size 12 13-0062 Size 13 13-0063 Size 14	Master Pins (Splits)
	13-0265 13-1769	Springs
	437S 437RC 437DG1 437DGM	Keying Kits
	13-1341	Slide

Cylinders

Degree Parts

Cylinders /
Keys

Program	Option	P/N	Description	Finishes
1-Week & 2-Week	DG1, 60, UC	34	Rim Cylinder	03, 04, 10, 10B, 10BE, 15, 32, 32D
		41	Mortise Cylinder (1-1/8")	
		42	Mortise Cylinder (1-1/4")	
		41-101	Mortise Cylinder with 101 Cam (13-0512) - (Adams Rite 1850 & 4700)	
		42-101	Mortise Cylinder with 101 Cam (13-0512) - (Adams Rite 1850 & 4700)	
	DG1, UC	C10-1	10, 7, 6500 Line Cylinder	04, 15
	DG1, UC	C10X-1	10X Line Cylinder (mechanical functions)	
	DG1, UC	C10X-1E	10X Line Cylinder (electrified functions)	
	DG1, UC	6300	LFIC Cylinder	

Cylinders

Degree Parts

SARGENT

ASSA ABLOY

www.sargentlock.com

Cylinders /
Keys

Program	P/N	Desc.	Finishes	Product
1-Week & 2-Week	DG-2894	Plug	04, 15	34
	DG-2911			41
	DG-2912			42
	DG-4653	Cylinder Shell	03, 04, 10, 10B, 26, 26D	34
	DG-4001			41
	DG-4002			42
	DG-0001	Standard Cam		41, 42
	DG-0016	Cam Screws		41, 42
	DG-0090	Retainer		34
	DG-0195	Tailpiece Retainer		34
	DG-0196	Rim Tail Piece		34
	DG-0040	Spring Cover		34, 41, 42
	13-0074	Standard Connecting Screws		34
	13-0086	Rim Cylinder Back Plate		34
	DG-3061	Plug w/Retainer	04, 15	6 Line, 6500 Line, 7 Line, 10 Line, 10X Line, 11 Line
	DG-0171	Cylinder Shell		6 Line, 6500 Line, 7 Line, 10 Line, 10X Line, 11 Line
	13-0680	Tail Piece Retainer		6500 Line, 7 Line, 10 Line, 10X Line, 11 Line
	13-0895	Tail Piece		6500 Line, 7 Line, 10 Line
	13-0907			6 Line (S & N knobs)
	13-0908			6 Line (B knob)
	13-1385			11 Line
	10-3629			Tail Piece Pack (used with mechanical functions)
	10-3791	Tail Piece Pack (used with electrified functions)	10X Line	
	DG-0090	Plug Retainer		6 Line, 6500 Line, 7 Line, 10 Line, 10X Line, 11 Line
	13-1341	Spring Cover		6 Line, 6500 Line, 7 Line, 10 Line, 10X Line, 11 Line
	DG-0200	Plug	04, 15	6300
	DG-0290	Cylinder Shell	04, 15	
	DG-0215	Control Sleeve		
	DG-0097	Compression Spring, LFIC		
	DG-0017	Compression Spring		
	DG-0090	Plug Retainer		
	DG-0059	Sidebar Spring		
	DG-0056	Sidebar		
	DG-0040	Spring Cover		
	437DG1	Pin Kit		
	DG-0027	0 Bottom Pins		All Cylinders
	DG-0021	1 Bottom Pins		
	DG-0022	2 Bottom Pins		
	DG-0023	3 Bottom Pins		
	DG-0024	4 Bottom Pins		
	DG-0025	5 Bottom Pins		
	DG-0026	6 Bottom Pins		
	DG-0051	1 Master Pins		
	DG-0052	2 Master Pins		
	DG-0053	3 Master Pins		
	DG-0054	4 Master Pins		
	DG-0055	5 Master Pins		
	DG-0246	6 Master Pins		
	DG-0051	1 Top Pins		
	DG-0052	2 Top Pins		
DG-0053	3 Top Pins			
DG-0054	4 Top Pins			
DG-0045	5 Top Pins			
DG-0044	6 Top Pins			
DG-0043	7 Top Pins			
DG-0042	8 Top Pins			
DG-0041	9 Top Pins			
DG-0246	6 Top Pins			
DG-0247	7 Top Pins			
DG-0248	8 Top Pins			
DG-0249	9 Top Pins			
DG-0250	10 Top Pins			
DG-0251	11 Top Pins			
DG-0252	12 Top Pins			
DG-0017	Compression Spring			

Cylinders

Keyblanks

Cylinders /
Keys

Program	Tools	Description	Keyways	Restricted Keyways
1-Week & 2-Week	6275	6 Pin Change/Day Keyblanks	L-Series: LA, LB, LC, LE, LF, LG, LJ, LK, LL H-Series: HA, HB, HC, HE, HF, HG, HJ, HK, HL R-Series: RA, RB, RC, RE, RF, RG, RJ, RK, RL	A-Series: AA, AB, AC, AE, AF, AG, AJ, AK, AL B-Series: BA, BB, BC, BE, BF, BG, BJ, BK, BL G-Series: GA, GB, GC,GE, GF, GG, GJ, GK, GL K-Series: KA, KB, KC, KE, KF, KG, KJ, KK, KL N-Series: NA, NB, NC, NE, NF, NG, NJ, NK, NL V-Series: VA, VB, VC, VE, VF, VG, VJ, VK, VL
	11-6275	6 Pin Change/Day Keyblanks	L-Series: LA, LB, LC, LE, LF, LG, LJ, LK, LL R-Series: RA, RB, RC, RE, RF, RG, RJ, RK, RL	N/A
	6 Pin Keyblanks (6285B)	Small Format 6 or 7 Pin Keyblanks	4A	4B
	7 Pin Keyblanks (7285B & 11-X7285B)			
	6270	6 Pin Master Keyblanks	L-Series: LD, LH, LM, LN, LDH, LDM, LHM H-Series: HD, HH, HM, HN, HDH, HDM, HHM R-Series: RD, RH, RM, RN, RDH, RDM, RHM	A-Series: AD, AH, AM, AN, ADH, ADM, AHM B-Series: BD, BH, BM, BDH, BDM, BN G-Series: GD, GH, GM, GN, GDM, GHD, GHM K-Series: KD, KH, KM, KN, KDH, KDM, KHM N-Series: ND, NH, NM, NN, NDH, NDM, NHM V-Series: VD, VH, VM, VN, VDH, VDM, VHM
11-6270	6 Pin Master Keyblanks (XC Cylinders)	L-Series: LD, LH, LM, LN, LDH, LDM, LHM R-Series: RD, RH, RM, RN, RDH, RDM, RHM	L Series: LD, LH, LM, LN, LDH, LDM, LHM R Series: RD, RH, RM, RN, RDH, RDM, RHM	

Note:

Restricted Keyblanks require a copy of end users Purchase Order or letter of authorization w/purchase order.

Program	6 Pin Change/Day Keyblanks	Patented Keyways
1 Week & 2 Week	DG6275	DG1: TA, TB, TC, TE, TF, TG, TJ, TK, TL
	DS6275	DG2, DG3: TA, TB, TC, TE, TF, TG, TJ, TK, TL
	DG6270	DG1: TD, TH, TM, TDH, THM, TN
	DS6270	DG2, DG3: TD, TH, TM, TDH, THM, TN

Degree DG1 Required Administrative Documents

All Degree DG1 Keyblank turbo ship orders require a system registration number and a letter of authorization if the product is shipped to an address other than what's recorded on the System Information Document and/or if the address on the purchase order is different than what is listed on the System Information Document.

Degree DG2 & DG3 Required Administrative Documents

A specific randomized security code will be required for each order unless "Opt-Out" has been authorized by the system administrator.

If the "Opt-Out" option is NOT selected

- A correct system specific (randomized) security code must be included with each subsequent order.
- *Security codes are specific to each order.
- If the shipping address is other than the one listed on the System Information Document, a Letter of Authorization signed by one of the recorded authorized representative of the facility must accompany the order.
- Letter of Authorization must contain the same shipping address that appears on the customer's purchase order.
- Letter of Authorization will not be kept on file at factory
- Without the proper security code, Letter of Authorization, or if the shipping address is other than what is listed on the System Information Document, the order cannot be processed.

If the "Opt Out" option WAS selected

- If the shipping address is other than the one listed on the System Information Document, a Letter of Authorization signed by one of the recorded authorized representative of the facility must accompany the order.
- Letter of Authorization must be signed by one of the facility's authorized representatives.
- Letter of Authorization must contain the same shipping address that appears on the customer's purchase order.
- Letter of Authorization will not be kept on file at factory

Bored Locks

11 Line

Bored
Locks

The SARGENT 11 Line is designed to meet the rigorous demands of Grade 1 bored lock applications. Its TZone construction enhances strength and durability, making it well-suited for high-traffic environments such as schools and hospitals. This design ensures reliable performance and exceeds ANSI/BHMA A156.2 Series 4000 Grade 1 standards.

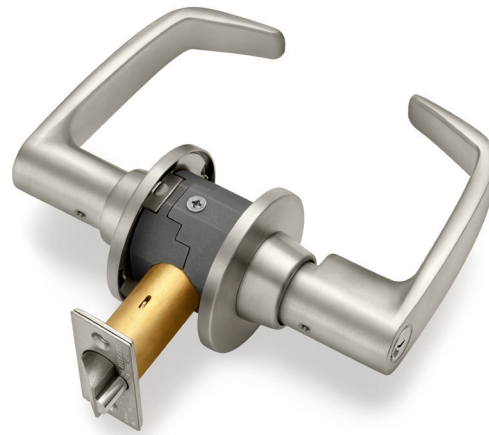

B Lever



L Lever



L Rose

(3-1/2" Diameter)



O Rose

(2-3/4" Diameter)



Program	Options	Functions	Rose	Lever	Finishes
1-Week	30, 60, 70, KD, LC, SC, WBS	28-11G04, 28-11G05, 28-11U15*, 28-11G16, 28-11G37, 28-11G38, 28-11U65*	L, O	B, L	10BE, 26D, BSP
2-Week			L		

Cylinder Options

- 30 Lever to accept Schlage cylinders - no cylinder provided
- 60 Disposable Construction Core
- 70 Interchangeable Core Disposable Plug
- KD Keyed Different
- LC Less Cylinder
- SC Schlage "C" Keyway

Functions

- 28-11G04 Storeroom
- 28-11G05 Office
- 28-11U15* Passage
- 28-11G16 Classroom/Security
- 28-11G37 Classroom
- 28-11G38 Security Classroom
- 28-11U65* Bathroom/Privacy

Mechanical Options

- WBS Wrought Box Strike

Finishes

- 10BE Dark Oxidized Satin Bronze - Equivalent
- 26D Satin Chrome

* Cylinder options are not available

Bored Locks

10X Line



The SARGENT 10X Line bored lock is engineered to secure and protect high-traffic, high-abuse spaces. It doesn't simply meet ANSI/BHMA Grade 1 performance standards for durability, strength and performance, it exceeds them - by as much as 20 times. That means occupants will experience reliable performance throughout its lifecycle.

Bored Locks

Program	Options	Functions	Rose	Lever	Finishes
24-Hour**	30, 60, 70, FW, KD, LC, RX, SC, WBS	10XG04, 10XG05, 10XG15, 10XG37, 10XU65	G, L	B, L, P, MD, ND, MB, MW	26D BSP
1-Week		10XG04, 10XG05, 10XU15*, 10XG15-3*, 10XG16, 10XG24, 10XG37, 10XG38, 10XU65*, 10XG70, 10XG71, 10XU93*, 10XU94*			
2-Week					

Cylinder Options

- 30 Lever to accept Schlage cylinders - no cylinder provided
- 60 Disposable Construction Core
- 70 Interchangeable Core Disposable Plug
- KD Keyed Different
- LC Less Cylinder
- SC Schlage "C" Keyway

Mechanical Options

- FW Freewheeling
- WBS Wrought Box Strike

Finishes

- 26D Satin Chrome
- BSP Black Suede Powder Coat

*Cylinder options are not available

**Limit of 25 units per order

Functions

- 10XG04 Storeroom
- 10XG05 Office
- 10XU15* Passage
- 10XG15-3* Exit or Twin Communicating
- 10XG16 Classroom Security Apartment/Exit/ Privacy
- 10XG24 Entrance/Office
- 10XG37 Classroom
- 10XU65* Bathroom/Privacy
- 10XG70 Fail Safe
- 10XG71 Fail Secure
- 10XU93* Single Lever Pull
- 10XU94* Double Lever Pull

B Lever



L Lever



P Lever



MB Lever



MD Lever



MW Lever

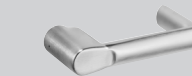

ND Lever



G Rose (3-1/2" Diameter)

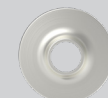

L Rose (3-1/2" Diameter)



Bored Locks

10X Line with VSL Indicator Trim

Bored
Locks

The SARGENT 10X Line with status indicator is designed for high-traffic, high-demand spaces that require both privacy and peace of mind. Built on a Grade 1 lock body, it exceeds ANSI/BHMA performance standards — by up to 20 times. With six customizable indicator windows, one-motion egress, and non-handed installation, it delivers instant lock-status visibility and lasting durability for restrooms, classrooms, and more.



Note: If the following indicator option codes are ordered, the trim required for the opposite side of the door must be specified:

- V30
- V60
- V03
- V06

If not specified, then LL will be provided.

Program	Options	Functions	Trim	Finishes
2-Week	30, 60, 70, FW, KD, LC, SC, WBS	10XG04, 10XG05, 10XG14, 10XG24, 10XG37, 10XG38*, 10XG44, 10XG53, 10XG54**, 10XU65, 10XU66, 10XU68	VSLL	26D

Indicator Options (must be specified)

- V30 Indicator Outside Only, Green/Red
- V60 Indicator Outside Only, White/Red
- V03 Indicator Inside Only, Green/Red
- V06 Indicator Inside Only, White/Red
- V33 Indicator Both Sides, Green/Red
- V66 Indicator Both Sides, White/Red

Cylinder Options

- 30 Lever to accept Schlage cylinders - no cylinder provided
- 60 Disposable Construction Core
- 70 Interchangeable Core Disposable Plug
- KD Keyed Different
- LC Less Cylinder
- SC Schlage "C" Keyway

Mechanical Options

- FW Freewheeling
- WBS Wrought Box Strike

Limit of 25 units per order

- * V03 or V06 only
- ** V30 or V60 only

Finishes

- 26D Satin Chrome

Functions

- 10XG04 Storeroom
- 10XG05 Office
- 10XG14 Patio/Privacy
- 10XG24 Entrance/Office
- 10XG37 Classroom
- 10XG38* Classroom Security Intruder
- 10XG44 Service Station
- 10XG53 Dormitory
- 10XG54** Dormitory
- 10XU65 Bathroom/Privacy
- 10XU66 Bathroom/Privacy
- 10XU68 Hospital Privacy

Bored Locks

7 Line



The SARGENT 7 Line is a key-in-lever lock designed for standard duty commercial interior and exterior applications in public buildings, medical offices, hotels/motels and government facilities. Exceeds ANSI/BHMA A156.2 Grade 2 standards for cycling and durability.

Bored Locks

Program	Options	Functions	Rose	Lever	Finishes
24-Hour	KD	7G04, 7G05, 7U15*, 7G37, 7U65*	L	L	26D
1-Week	1, 20, 30, 60, 70, KD, LC, SC, WBS	7G04, 7G05, 7U15*, 7G15-3*, 7G37, 7U65*, 7U93*, 7U94*		B, L, P	10BE, 26D
2-Week					10BE, 26D, BSP

Cylinder Options

- 30 Lever to accept Schlage cylinders - no cylinder provided
- 60 Disposable Construction Core
- 70 Interchangeable Core Disposable Plug
- KD Keyed Different
- LC Less Cylinder
- SC Schlage "C" Keyway

Mechanical Options

- 1 for 1-3/8" thick door
- 20 for 2-3/8" Backset
- 29 2-3/4" (70mm) curved lip strike #800
- WBS Wrought Box Strike

Functions

- 7G04 Storeroom
- 7G05 Office
- 7U15* Passage
- 7G15-3* Exit or Twin Communicating
- 7G37 Classroom
- 7U65* Bathroom/Privacy
- 7U93* Single Lever Pull
- 7U94* Double Lever Pull

Finishes

- 10BE Dark Oxidized Satin Bronze - Equivalent
- 26D Satin Chrome
- BSP Black Suede Powder Coat

B Lever



L Lever



P Lever



L Rose

(3-1/2" Diameter)



* Cylinder options are not available

Bored Locks

6500 Line

Bored
Locks

A standard duty key-in-lever lock designed to exceed the requirements of ANSI/BHMA A156.2 Series 4000 Grade 2.



L Lever



K Rose

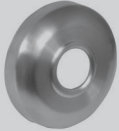

Program	Options	Functions	Rose	Lever	Finishes
1-Week & 2-Week	KD, SC, 20, LC, WBS	65G04, 65G05, 65U15*, 65G37, 65U65*, 65U93*, 65U94*	K	L	10BE, 26D

Cylinder Options

- KD Keyed Different (LA Keyway Only)
- SC Schlage "C" Keyway
- LC Less Cylinder

Mechanical Options

- 20 for 2-3/8" Backset
- 29 2-3/4" (70mm) curved lip strike #800
- WBS Wrought Box Strike

Functions

- 65G04 Storeroom
- 65G05 Office
- 65U15* Passage
- 65G37 Classroom
- 65U65* Bathroom/Privacy
- 65U93* Single Lever Pull
- 65U94* Double Lever Pull

Finishes

- 10BE Dark Oxidized Satin Bronze - Equivalent
- 26D Satin Chrome

* Cylinder options are not available

Bored Locks

8X Line



The SARGENT 8X Line is designed and tested for robust applications. The ANSI/BHMA A156.2 Grade 1 bored-in lock is a worry free solution.

Bored Locks

Program	Options	Functions	Rose	Knob	Finishes
24-Hour	WBS	8XG04, 8XG05, 8XU15, 8XG17, 8XG37, 8XU65, 8XU93	L	B	32D
1-Week					

Finishes

32D Satin Stainless Steel

Mechanical Options

29 2-3/4" (70mm) curved lip strike #800
 WBS Wrought Box Strike

Functions

8XG04 Storeroom
 8XG05 Office
 8XU15 Passage
 8XG17 Utility
 8XG37 Classroom
 8XU65 Bathroom/Privacy
 8XU93 Single Knob Pull

B Knob



L Rose

(3-1/2" Diameter)



Bored Locks

HP ALP Trim

Bored
Locks

The HP Series Bored Lock with ALP push/pull trim provides an aesthetically pleasing alternative to standard push/pull products. Ease of operation allows its use in many environments, including healthcare and education. The paddle shape and location create a comfortable target for door activation without using hands.



Passage



Privacy



Program	Options	Functions	Trim	Finishes
1-Week & 2-Week	14, 24, 28, WBS	HPU15, HPU65*	ALP	32D

Mechanical Options

- 14- 505 Full Lip Strike
- 24- 2-3/4" (70mm) backset
- 28- 4-7/8" (124mm) ANSI curved lip strike # 808
- WBS Wrought Box Strike

Finishes

- 32D Satin Stainless Steel

Hand

- LH Left Hand
- RH Right Hand

Functions

- HPU15 Passage
- HPU65 Privacy*

Note: Maximum quantity of 15 units per order

* Handed

Bored Locks

DL Series



The DL Series tubular lock is designed for ease of installation with the quality you expect from the SARGENT name. The DL Series exceeds the expectations of the most demanding architects and design professionals. All Studio Collection and Coastal Series levers, as well as standard levers, can be used with the DL Series.

Bored Locks

Program	Options	Functions	Rose	Lever	Finishes
1-Week	12-, 14-, 20-, 28-, WBS-	DLU15, DLU15-3, DLU65, DLU93, DLU94	LN*, O	MD, ME, MI, MJ, ND, NJ, REM (32D only)	10BE, 15, 26D, 32D
2-Week				MD, ME, MG, MI, MJ, ND, NJ, REM (32D only)	10BE, 15, 26D, 32D, BSP

Options

- 12 UL Listed for 3 hour fire rated doors
- 14 505 Full lip strike
- 20 2-3/8" backset latch with square corner front 2-1/4" x 1" front
- 28 Strike #808. Lip length 1-1/4"
- WBS Wrought box strike

Finishes

- 10BE Dark Oxidized Satin Bronze - Equivalent
- 15 Satin Nickel
- 26D Satin Chrome
- 32D Satin Stainless Steel (Available with REM only)
- BSP Black Suede Powder Coat

Functions

- DLU15 Passage
- DLU15-3 Communicating set
- DLU65 Privacy set
- DLU93 Single lever pull
- DLU94 Double lever pull

Hand

- LH Left Hand
- RH Right Hand

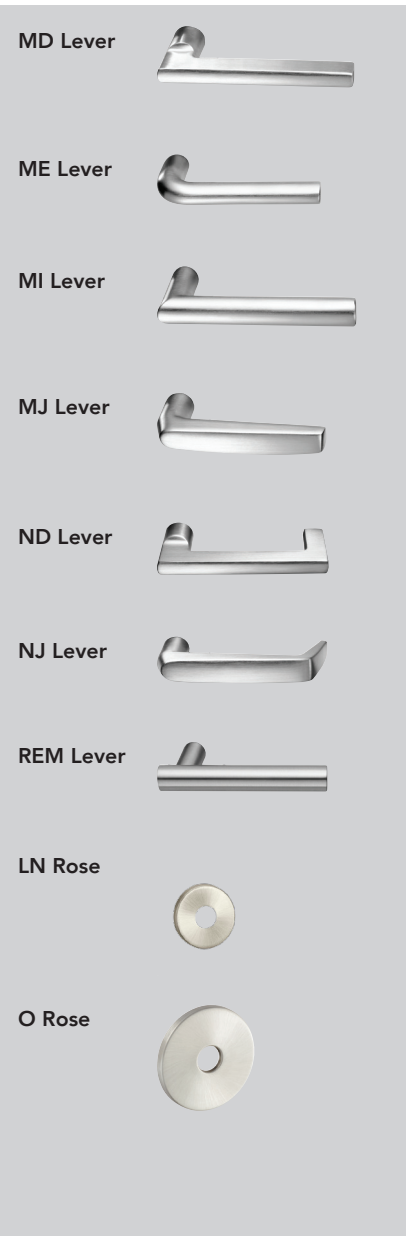

* Available with DLU93 and DLU94 functions only
 Note: Maximum quantity of 100 units per order

Bored Locks

10X Line, 10 Line, 7 Line and 6 Line

Bored Locks

10X Line Parts

Program	Part #	Description	Finishes
1-Week, 2-Week	10-2000	Latches - Guarded - 2-3/4" BS	26D
	10-2022	Latches - Unguarded - 2-3/4" BS	
	10-1200	Inside and Outside Rose Scalp - L	
	10-1202	Inside and Outside Rose Scalp - G	

7 Line Parts

Program	Part #	Description	Finishes
1-Week, 2-Week	10-0501	Levers - I/S or O/S "L" design, Passage	26D
	10-0502	Levers - I/S or O/S "L" design, Cylinder, Emerg.	
	10-0503	Levers - I/S or O/S "L" design, Turn, 30 option	
	10-0523	Levers - I/S or O/S "B" design, Passage	
	10-0524	Levers - I/S or O/S "B" design, Cylinder, Emerg.	
	10-0525	Levers - I/S or O/S "B" design, Turn, 30 option	
	10-0545	Levers - I/S or O/S "P" design, Passage	
	10-0546	Levers - I/S or O/S "P" design, Cylinder, Emerg.	
	10-0547	Levers - I/S or O/S "P" design, Turn, 30 option	
	10-2070	Screw Packs (28-) (Standard)	
10-2052	Screw Packs (29-)		

7 Line Parts

Program	Part #	Description	Finishes
1-Week, 2-Week	07-2430	Latches - Guarded - 2-3/4" BS	32D
	07-2432	Latches - Unguarded - 2-3/4" BS	
	07-0111	Rose Scalp (All functions)	26D
	07-2425	Inside Rose Body (all except 94, 94-2)	Standard
	07-2426	Outside Rose Body (all except 93, 94, 94-2, 15-3)	
	07-2648	1-3/8" Door Mounting Kit	
	07-2446	Through-bolt Mounting Pack	
	07-2431	7 Line Latch (2-3/8" Guarded)	32D
	07-2433	7 Line Latch (2-3/8" Unguarded)	

6 Line Parts

Program	Part #	Description	Finishes
1-Week, 2-Week	800	Strikes	10B, 32D
	06-5083	Latches - Guarded - 2-3/8"	
	06-5225	Latches - Unguarded - 2-3/8"	
	06-2675	Screw Packs	Standard
	06-5056	Screw Packs	
	06-5057	Screw Packs	

Mortise Locks

8200 Series with Trim



The 8200 Series far surpasses ANSI/BHMA A156.13 Series 1000 Grade 1 certification, making it the strongest and most durable mortise lock in the industry.

Program	Options	Functions	Rose	Lever	Finishes
24-Hour	KD, RX, WBS	8204, 8205, 8215, 8225, 8237, 8265, 8270 ¹ , 8271 ¹	LN	B, J, L, P, MD, MI	26D, 32D
1-Week	56, 60, 70, KD, LC, LX, RX, SC, WBS	8204, 8205, 8215, 8217, 8225, 8237, 8238, 8239, 8240, 8241, 8243, 8245, 8255, 8265, 8270 ¹ , 8271 ¹ , 8272 ¹ , 8273 ¹ , 8293, 8294	LN, LW1 ³ , O, WT ³	B, J, L, P, MD ² , ME ² , MI ² , MJ ² , ND ² , NJ ² , REM (32D Only)	10B, 10BE, 15, 26D, 32D
2-Week				B, J, L, P, MD ² , ME ² , MI ² , MJ ² , ND ² , NJ ² , REM (32D Only)	10, 10B, 10BE, 15, 26D, 32D, BSP

Options

56	Motorized Electric Latch Retraction
60	Disposable Construction Core
70	Interchangeable Core Disposable Plug
KD	Keyed Different
LC	Less Cylinder
RX	Request to Exit
SC	Schlage "C" Keyway
WBS	Wrought Box Strike
LX	Latchbolt Monitor

Finishes

10	Dull Bronze
10B	Oxidized Dull Bronze
10BE	Dark Oxidized Satin Bronze - Equivalent
15	Satin Nickel
26	Bright Chrome
26D	Satin Chrome
32D	Stainless Steel
BSP	Black Suede Powder Coat

Functions

8204	Night Latch or Storeroom
8205	Office or Entry
8215	Passage
8217	Asylum or Institutional
8225	Dormitory or Exit
8237	Classroom
8238	Classroom Security
8239	Classroom Security with Deadbolt
8240	Classroom Security with Deadbolt
8241	Classroom Security
8243	Apartment
8245	Dormitory
8255	Office w/Toggle
8265	Bathroom
8270	Fail Safe - Single Cylinder
8271	Fail Secure - Single Cylinder
8272	Fail Safe - Double Cylinder
8273	Fail Secure - Double Cylinder
8293	Single Dummy
8294	Trim Dummy

Voltage (Available on 8270, 8271, 8272, 8273 only)

12V
24V

Hand

LH Left Hand
RH Right Hand

B Lever



J Lever



L Lever

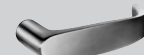

P Lever



MD Lever



ME Lever



MI Lever



MJ Lever



ND Lever



NJ Lever



REM Lever



LW1
(2" x 8")

WT
(2-1/2" x 7-3/8")

LN Rose
(2" Diameter)



O Rose
(2-3/4" Diameter)



Mortise Locks

1. Electrified products have a total maximum quantity of 50 locks per order
2. Maximum quantity of 100 units per order
3. Not available with Studio Collection Levers
4. 56- only available on 8204, 8215, 8217

Mortise Locks

Status Indicator Upgrade Kits

Used in a variety of applications, status indicators are most commonly used to identify occupancy or display the locked/unlocked status of a room.



Mortise Locks

Program	Model #	Used with Functions	Finishes	Available Option Codes	Indicator Location*
1-Week & 2-Week	SA190	20, 21, 22, 24, 25, 26, 28, 29, 30, 39, 40, 41, 43, 45, 46, 47, 50, 51, 52, PHR-NAC-82281	26D, 32D	Outside Trim: V10, V10F, V20, V20F, V30, V40, V50, V60 Inside Trim: V01, V01F, V03, V04, V06	Inside and/or Outside per Function
	SA191	36, 56, 57, 58, 67	26D, 32D		
	SA192	05, 37, 38, 42, 59	26D, 32D		
	SA193	65, 66, 68	26D, 32D	V10, V10F, V20, V20F, V30, V40, V50, V60	Outside
	SA194	21, 24, 25, 28, 43, 45, 47, 50, 51, 66, 68, PHR-NAC-82281, PHR-NAC-82285	26D, 32D	V01, V01F, V03, V04, V06	Inside
	SA196	12, 56, 57, 58, 65, 67	26D, 32D		
	SA198	05	26D, 32D		
SA197	30, 37, PHR-NAC-82285	26D, 32D	Outside Trim: V10, V10F, V20, V20F, V30, V40, V50, V60 Inside Trim: V01, V01F, V03, V04, V06	Inside or Outside per Function	

*When indicators are required on both sides of the door, 2 upgrade kits must be ordered, one kit for each side. Cylinder not included.

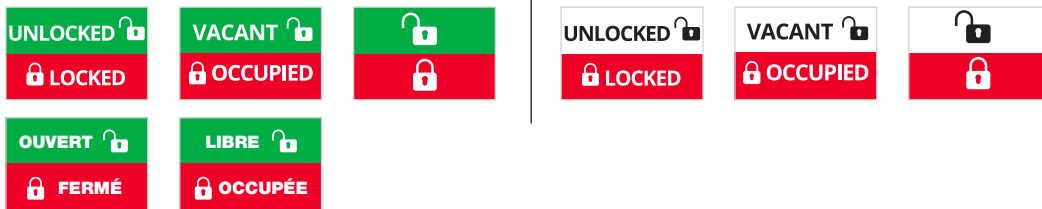

Option Code	Wording	Color	Mounting Location
V10	Unlocked/Locked	Green/Red	Outside of Door
V10F	Ouvert/Fermé	No Indicator	Green/Red
V20	Vacant/Occupied	Green/Red	Outside of Door
V20F	Libre/Occupée	No Indicator	Green/Red
V30	Icons Only	Green/Red	Outside of Door
V40	Unlocked/Locked	White/Red	Outside of Door
V50	Vacant/Occupied	White/Red	Outside of Door
V60	Icons Only	White/Red	Outside of Door
V01	Unlocked/Locked	Green/Red	Inside of Door
V01F	No Indicator	Ouvert/Fermé	Green/Red
V03	Icons Only	Green/Red	Inside of Door
V04	Unlocked/Locked	White/Red	Inside of Door
V06	Icons Only	White/Red	Inside of Door

Mortise Locks

8200 Series with BHW Trim



Part of the Behavioral Health Series™ of products, the 8200 mortise lock with BHW trim provides an innovative solution for behavioral health environments. The unique integrated lever and escutcheon combines aesthetics with safety.

Mortise Locks

Program	Options	Functions	Trim	Finishes
1-Week	60, 70, KD, LC, SC, WBS	8204, 8205, 8215, 8225*, 8237, 8238, 8239*, 8240*, 8241*, 8243*, 8245*, 8255, 8265, 8270, 8271, 8272, 8273	BHW	32D
2-Week	60, 70, KD, LC, SC, DX, LX, RX, WBS			

Options

- 60 Disposable Construction Core
- 70 Interchangeable Core Disposable Plug
- KD Keyed Different
- LC Less Cylinder
- SC Schlage "C" Keyway
- DX Deadbolt Monitoring
- LX* Latchbolt Monitoring
- RX Request to Exit
- WBS Wrought Box Strike

Finishes

- 32D Stainless Steel

* Latchbolt monitoring not available with deadbolt functions

Note: BHW trim has a total maximum quantity of 15 locks per Turboship order

Functions

- 8204 Night Latch or Storeroom
- 8205 Office or Entry
- 8215 Passage
- 8225* Dormitory or Exit
- 8237 Classroom
- 8238 Classroom Security
- 8239* Classroom Security with Deadbolt
- 8240* Classroom Security with Deadbolt
- 8241* Classroom Security
- 8243* Apartment
- 8245* Dormitory
- 8255 Office w/Toggle
- 8265 Bathroom
- 8270 Fail Safe - Single Cylinder
- 8271 Fail Secure - Single Cylinder
- 8272 Fail Safe - Double Cylinder
- 8273 Fail Secure - Double Cylinder

Hand

- LH Left Hand
- RH Right Hand

Mortise Locks

8200 Series with ALP Trim

Heavy-duty push/pull hardware that is flexible, easy to use and aesthetically pleasing; it's appropriate for healthcare settings and beautiful enough for healing environments. This trim offers multiple mounting options and easy operation, even when your hands aren't free.



Mortise
Locks

Program	Options	Functions	Trim	Finishes
1-Week & 2-Week	KD, LC, SC, WBS, 60, 70	8204, 8205, 8215, 8237, 8265, 8270, 8271	ALP	32D

Options

- 60 Disposable Construction Core
- 70 Interchangeable Core Disposable Plug
- KD Keyed Different
- LC Less Cylinder
- SC Schlage "C" Keyway
- WBS Wrought Box Strike

Finishes

- 32D Stainless Steel

Functions

- 8204 Night Latch or Storeroom
- 8205 Office or Entry
- 8215 Passage
- 8237 Classroom
- 8265 Bathroom
- 8270 Fail Safe - Single Cylinder
- 8271 Fail Secure - Single Cylinder

Hand

- LH Left Hand
- RH Right Hand

Note: Maximum quantity of 15 units per order

Note: See page 23 for status indicator upgrade kits

Mortise Locks

8200 Series Lockbody Only



The 8200 Series mortise lock far surpasses ANSI/BHMA A156.13 Series 1000 Grade 1 standards, making it the strongest and most durable mortise lock in the industry.

Mortise Locks

Program	Options	Functions	Finishes
24-Hour	WBS	8204, 8205, 8215, 8225, 8237, 8265	26D, 32D
1-Week & 2 Week		8204, 8205, 8215, 8225, 8237, 8238, 8239, 8240, 8241, 8243, 8245, 8255, 8265, 8270, 8271, 8272, 8273	10B, 10BE, 15, 26, 26D, 32D, BSP

Options

WBS Wrought Box Strike

Finishes

- 03 Bright Brass
- 10 Dull Bronze
- 10B Oxidized Dull Bronze
- 10BE Dark Oxidized Satin Bronze - Equivalent
- 15 Satin Nickel
- 26 Bright Chrome
- 26D Satin Chrome
- 32D Stainless Steel
- BSP Black Suede Powder Coat

Functions

- 8204 Night Latch or Storeroom
- 8205 Office or Entry
- 8215 Passage
- 8225 Dormitory or Exit
- 8237 Classroom
- 8238 Classroom Security
- 8239 Classroom Security with Deadbolt
- 8240 Classroom Security with Deadbolt
- 8241 Classroom Security
- 8243 Apartment
- 8245 Dormitory
- 8255 Office w/Toggle
- 8265 Bathroom
- 8270 Electromechanical (Fail Safe)
- 8271 Electromechanical (Fail Secure)
- 8272 Electromechanical (Fail Safe)
- 8273 Electromechanical (Fail Secure)

Hand

- LH Left Hand
- RH Right Hand
- LHR Left Hand Reverse
- RHR Right Hand Reverse

Mortise Locks

Mechanical Parts & Accessories

Mortise
Locks

Program	Part #	Description
1-Week, 2-Week	01-1028	#8-32 x 1/4" Mortise Outside Front Screws (03, 04, 10, 10B, 15,26, 26D)
	01-5002	#12 Combination Latch Screw (mortise lock mounting screw)
	01-0079	Washer
	01-1174	Lever Set Screw (B, J, L, P, W Levers)
	01-1472	Lever Set Screw (A, E, F Levers)
	01-1495	Machine Screw #8-32 x 5/8"
	130KB	Thumbturn (Specify 03, 10, 10B, 26, 26D, 32D)
	130W	Thumbturn (Specify 03, 10, 10B, 26, 26D, 32D)
	184KB	Emergency Release (Specify 03, 10, 10B, 26, 26D, 32D)
	184W	Emergency Release (Specify 03, 10, 10B, 26, 26D, 32D)
	77-3468	Screw Pack 1-3/4" Dr (KE2/LE2 Trim)
	77-1141	Strike Box (for 8200 & 808 strikes)
	77-4236	Lockbody Screw Pack (All trim, specify 03, 04, 10, 10B, 32, 32D)
	81-0723	Mounting Post
	82-0110	Standard Curve Lip Strike (03, 04, 10, 10B, 10BE, 32, 32D)
	82-0184	Cap Nut (Std O/S Lever)
	82-0612	Wave Spring for Rose
	82-2136	Trim Pack Kits - E, O, KW, L (7894) LN, LW - 94 Function
	82-2137	Trim Pack Kits - KE1, KE2, LE1, LE2, KS, LS - 94 Function
	82-2138	Trim Pack Kits - L (8294), WT - 94 Function
	82-2135	Trim Pack Kits - L (8293), WT - 93 Function
	82-3211	Trim Pack Kits - E, O, KW, L (7800), LN, LW
	82-3212	Trim Pack Kits - KE1/LE1, KE2/LE2, KE3/LE3, KE4/LE4
	82-4611	Trim Pack Kit - One-sided Trim - 06,13,31,36 Function
	82-3213	Trim Pack Kits - L (8200), WT - All
	82-3341	Screw Pack - 1-3/4" Dr. (KE1/LE1, KE3/LE3, KW/LW Trim)
	82-3654	Screw Pack - All Door Thickness (WT Trim)
	82-3675	Screw Pack - 1-3/4" Dr (FE trim)

Door Control

Powerglide 281 Series



281 Door Closer

Surface door closers for interior and exterior doors with flexibility to meet virtually every application. A full complement of arm types and front-facing valves make installation and maintenance easy.

Program	Options	Arm Types	Finishes
24-Hour	-	O, UO	EN
1-Week & 2-Week	DA, TB	O, CPS, PS, P10, PH10, CPSH, PSH, P9, UH, UO	EAB, EB, EN, EP, 10BE, BSP

Arm Types		Finishes	
UH	Universal Hold Open STD, Parallel, Top Jamb	EB	Bronze Enamel to match 10B
RUO	Universal Arm STD, Parallel, Top Jamb RUO	EN	Aluminum Enamel
UO	Universal Arm STD, Parallel, Top Jamb RUO	EP	Bronze Enamel to match US10
CPS	Heavy Duty Parallel Arm with Compression Stop	EAB	Brass Enamel to be used with brass finishes
PS	Heavy Duty Parallel Arm with Positive Stop	10BE	Dark Oxidized Satin Bronze - Equivalent
P9	Standard Parallel Arm RP9	BSP	Black Suede Powder Coat
RP9	Standard Parallel Arm RP9		
RO	Standard Arm Standard & Top Jamb RO		
O	Standard Arm Standard & Top Jamb RO		
P10	Heavy Duty Parallel Arm		
PH10	Heavy Duty Friction Hold Open Parallel Arm (specify LH or RH)		
CPSH	Heavy Duty Hold Open Parallel Arm with Compression Stop		
PSH	Heavy Duty Hold Open Parallel Arm with Positive Stop		

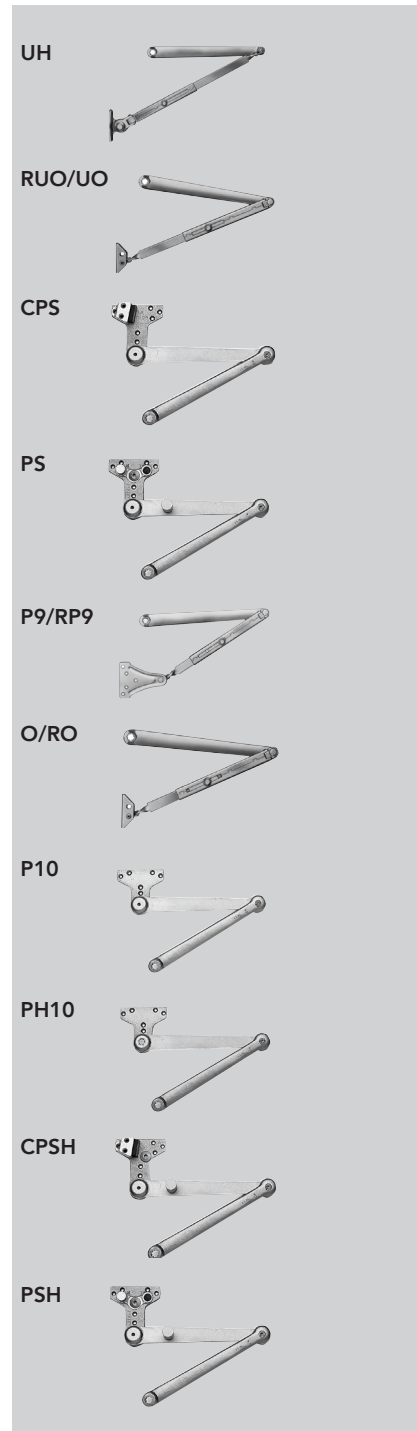

Door Control

Door Control

Powerglide 351 Series

Surface door closers for interior and exterior doors with flexibility to meet virtually every application. A full complement of arm types and front-facing valves make installation and maintenance easy.



351 Door Closer

Door Control

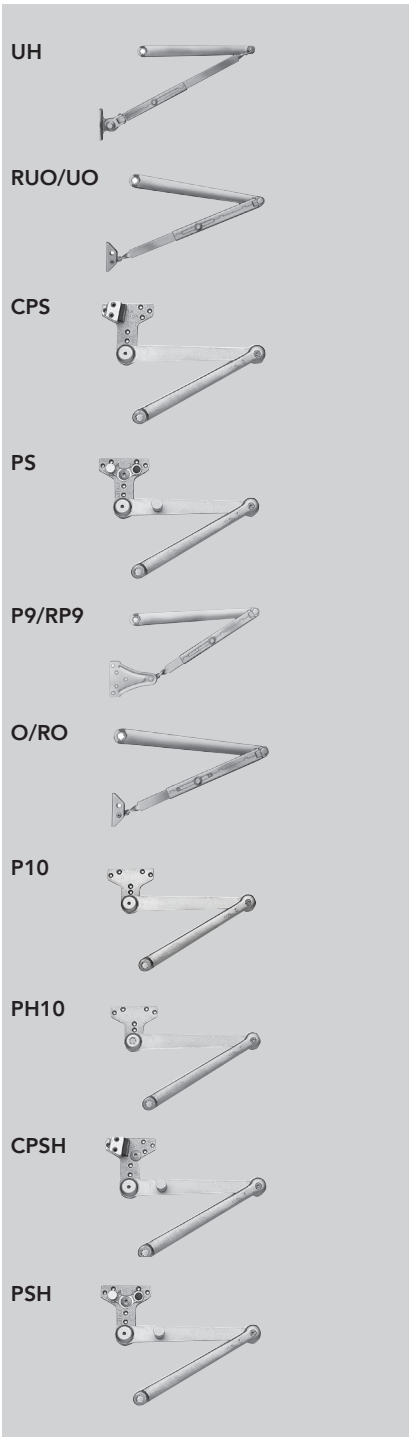

Program	Options	Arm Types	Finishes
24-Hour	-	O, UO, RO*, RUO*	EN
1-Week & 2-Week	DA, TB	O, CPS, PS, P10, PH10, CPSH, PSH, P9, UH, UO, RO*, RP9*, RUO*	EAB, EB, EN, EP, 10BE, BSP

Arm Types

- UH Universal Hold Open STD, Parallel, Top Jamb
- RUO Universal Arm STD, Parallel, Top Jamb RUO
- UO Universal Arm STD, Parallel, Top Jamb RUO
- CPS Heavy Duty Parallel Arm with Compression Stop
- PS Heavy Duty Parallel Arm with Positive Stop
- P9 Standard Parallel Arm RP9
- RP9 Standard Parallel Arm RP9
- RO Standard Arm Standard & Top Jamb RO
- O Standard Arm Standard & Top Jamb RO
- P10 Heavy Duty Parallel Arm
- PH10 Heavy Duty Friction Hold Open Parallel Arm (specify LH or RH)
- CPSH Heavy Duty Hold Open Parallel Arm with Compression Stop
- PSH Heavy Duty Hold Open Parallel Arm with Positive Stop

Finishes

- EB Bronze Enamel to match 10B
- EN Aluminum Enamel
- EP Bronze Enamel to match US10
- EAB Brass Enamel to be used with brass finishes
- 10BE Dark Oxidized Satin Bronze - Equivalent
- BSP Black Suede Powder Coat

Door Control

Powerglide 1431 Series



1431 Door Closer

Surface door closers for interior and exterior doors with flexibility to meet virtually every application. A full complement of arm types and front-facing valves make installation and maintenance easy.

Program	Options	Arm Types	Finishes
24-Hour	–	O, UO, RO*, RUO*	EN
1-Week & 2-Week	DA, TB	O, CPS, PS, P10, PH10, CPSH, PSH, P9, UH, UO, RO*, RP9*, RUO*	EAB, EB, EN, EP, 10BE, BSP

Arm Types		Finishes	
UH	Universal Hold Open STD, Parallel, Top Jamb	EB	Bronze Enamel to match 10B
RUO	Universal Arm STD, Parallel, Top Jamb RUO	EN	Aluminum Enamel
UO	Universal Arm STD, Parallel, Top Jamb RUO	EP	Bronze Enamel to match US10
CPS	Heavy Duty Parallel Arm with Compression Stop	EAB	Brass Enamel to be used with brass finishes
PS	Heavy Duty Parallel Arm with Positive Stop	10BE	Dark Oxidized Satin Bronze - Equivalent
P9	Standard Parallel Arm RP9	BSP	Black Suede Powder Coat
RP9	Standard Parallel Arm RP9		
RO	Standard Arm Standard & Top Jamb RO		
O	Standard Arm Standard & Top Jamb RO		
P10	Heavy Duty Parallel Arm		
PH10	Heavy Duty Friction Hold Open Parallel Arm (specify LH or RH)		
CPSH	Heavy Duty Hold Open Parallel Arm with Compression Stop		
PSH	Heavy Duty Hold Open Parallel Arm with Positive Stop		

* Available with 1431 Series door closer only

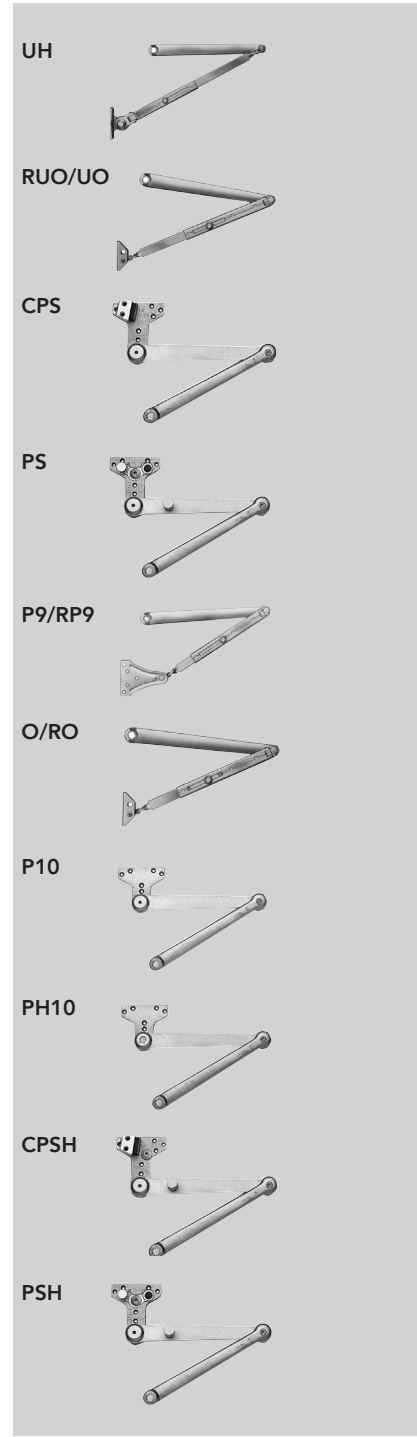

Door Control

Door Control

1331 Series

The SARGENT 1331 Series door closer can be used for the most common applications and is a Grade 1 fully adjustable closer. Available with a selection of arms and accessories, the 1331 Series door closer can be used for most common applications and is ideal for standard duty installations.

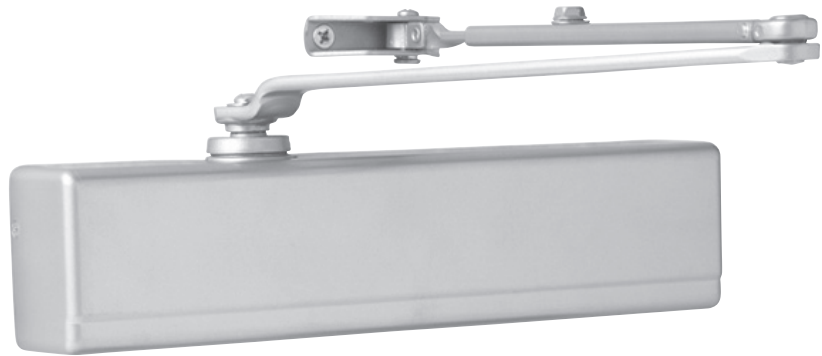

Door Control

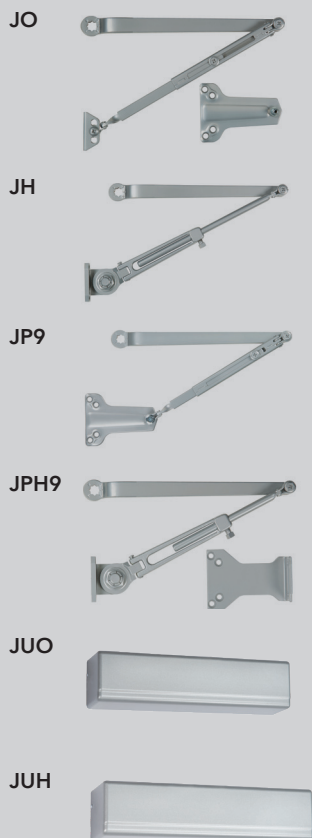

Program	Options	Arm Types	Finishes
1-Week & 2-Week	TB	JH, JO, JP9, JPH9, JUH, JUO	10BE, EAB, EB, EN, EP, BSP

Arm Types

JO	Arm Standard/Top Jamb
JH	Hold Open Arm Standard
JP9	Arm Parallel
JPH9	Hold Open Arm Parallel
JUO	Tri Pack or "Universal Packed"
JUH	Hold Open Tri Pack or "Universal Packed"

Finishes

EB	Bronze Enamel to match 10B
EN	Aluminum Enamel
EP	Bronze Enamel to match US10
EAB	Brass Enamel to be used with brass finishes
10BE	Dark Oxidized Satin Bronze - Equivalent
BSP	Black Suede Powder Coat

Door Control

1131 Series

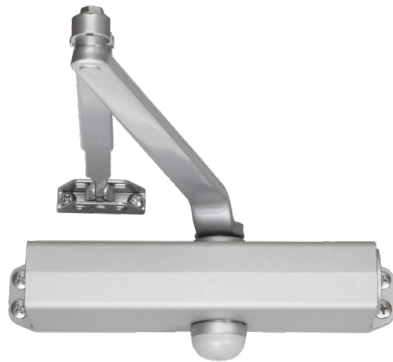

A reversible "Non-handed" economy aluminum door closer.

Program	Options	Arm Types	Finishes
1-Week & 2-Week	TB	HU, RU	EB, EN

Product Designation Based on Application

1131 Adjustable for sizes 1 through 6. Ideal for use on aluminum storefronts and other medium traffic, commercial applications. Complies with opening force requirements outlined in the Americans with Disabilities Act (A.D.A.) and ANSI A117.1 for interior doors.

Arm Types

HU Hold-Open Arm Bracket
RU Regular Parallel Arm Bracket

Finishes

EB Bronze Enamel to match 10B
EN Aluminum Enamel

Options

TB Aluminum Enamel

HU



RU

Door
Control

Door Control

422 Series

The high performance design of the 422 Cam Action Closer ensures doors that are light to open for ADA compliance, with the right amount of closing force to handle a wide range of environments. The closer's non-hold open track and internal spring are specifically built to protect the door and frame in abusive, high-traffic conditions.



Door Control

CTB2



CTHB2



422D



63-0853-EN

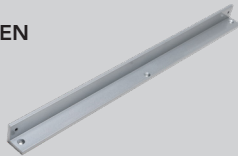

Program	Options	Arm Types	Finishes
1-Week & 2-Week	TB	CTB2, CTHB2	EB, EN, 10BE, BSP

Arm Types

CTB2	Pull with Bumper
CTHB2	Pull with Holder and Bumper
422D	Drop/Back Plate

Hand

LH	Left Hand
RH	Right Hand

Finishes

EB	Bronze Enamel to match 10B
EN	Aluminum Enamel
10BE	Dark Oxidized Satin Bronze - Equivalent
BSP	Black Suede Powder Coat

Note: Maximum quantity of 40 units per order

Door Control

Overhead Holders & Stops

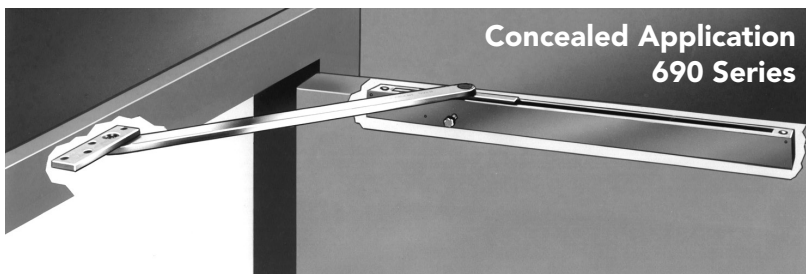
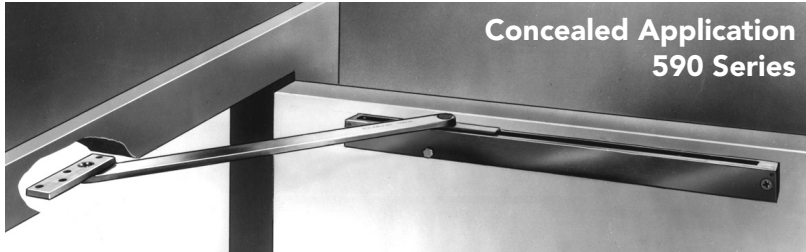

Overhead holders and stops are used to extend the life of the door, frame and door closing devices on an opening. SARGENT offers both concealed and surface mount types, with various functions and degree of opening.

Door
Control

Program	Product Designation	Options	Finish
1-Week, 2-Week	597,598,599 697, 698, 699 1546,1547,1548, 1549	H, S	26D

Product Designation

590 Series

- 597 24" - 32-1/2" Door Width
- 598 32-5/8" - 39-1/8" Door Width
- 599 39-1/4" or Greater Door Width

690 Series

- 697 24" - 32-1/2" Door Width
- 698 32-5/8" - 39-1/8" Door Width
- 699 39-1/4" or Greater Door Width

1540 Series

- 1546 18-1/2" - 25" Door Width
- 1547 25-1/8" - 32-1/2" Door Width
- 1548 32-5/8" - 40" Door Width
- 1549 40-1/8" - 48" Door Width

Finishes

- 26D Satin Chrome

Options

- H Hold Open with Stop
- S Stop Only

Note: Maximum quantity of 15 units per order

Door Control

Door Closer Parts

Program	Part #	Description	Finishes
24-Hour	25 O	Standard Arm – Complete Arm assy.	EN
	25 UO	Universal Arm - Complete Arm assy.	
	25 P9	Parallel Arm – Complete Arm assy.	
	25 P10	Parallel Heavy Duty Arm – Complete Arm assy.	
	25 PH10	Parallel Holder Heavy Duty Arm (Left Hand)	
	25 PH10	Parallel Holder Heavy Duty Arm (Right Hand)	
	25 PS	Parallel Stop Arm – Complete Arm assy.	
	25 PSH	Parallel Stop/Holder Arm – Complete Arm assy.	
	25 CPS	Compression Stop Arm – Complete Arm assy.	
	25 CPSH	Compression Holder Arm – Complete Arm assy.	
	63-2216	Foot assy. (O, OLC, RO, UO, RUO arms)	
	63-3070	Main arm & swivel assy. (H, H8, PH4, PH9, PF9, UH arms)	
	63-0641	Arm & bearing assy. (P10, CPS, PS, CPSH, PSH arms)	
	63-2607	Main arm & link assy. (O, O8, OZ, OZA, P3, P3A, P4A, P9, RP9 arms)	
	63-3493	Bumper only - (CPS, CPSH arms) use w/ 63-0516	
	63-3727	Arm and bracket assy. (P10 arm)	
	63-3830	Arm and bracket assy. (CPS arm)	
	63-3833	Arm and bracket assy. (PSH arm)	
63-3836	Arm and bracket assy. (CPSH arm)		
63-3837	Arm and bracket assy. (PS arm)		
1-Week & 2-Weeks	25 O	Standard Arm – Complete Arm assy.	10BE, EN, EB, EP, EAB, BSP
	25 UO	Universal Arm - Complete Arm assy.	
	25 H	Holder Arm – Complete Arm assy.	
	25 P9	Parallel Arm – Complete Arm assy.	
	25 PH9	Parallel Holder Arm – Complete Arm assy.	
	25 P10	Parallel Heavy Duty Arm – Complete Arm assy.	
	25 PH10	Parallel Holder Heavy Duty Arm (Left Hand)	
	25 PH10	Parallel Holder Heavy Duty Arm (Right Hand)	
	25 PS	Parallel Stop Arm – Complete Arm assy.	
	25 PSH	Parallel Stop/Holder Arm – Complete Arm assy.	
	25 CPS	Compression Stop Arm – Complete Arm assy.	
	25 CPSH	Compression Holder Arm – Complete Arm assy.	
	581-1	Blade Stop Spacer Kit	10BE, EN, EB, EAB, BSP
	581-2	Blade Stop Spacer Kit	
	61-2303	Foot assy. - (H, HZ, HZA, PH4, PH9, UH-Arms)	
	63-0516	Bumper holder - (CPS, CPSH - Arms)	
	63-2216	Foot assy. - (O, OLC, RO, UO, RUO - Arms)	
	63-2217	Foot assy. - (OZ - Arm)	
	63-2218	Foot assy. - (OZA, FZA - Arm)	
	63-3070	Main arm & swivel assy. (H, H8, PH4, PH9, PF9, UH arms)	
	63-2230	Main arm & link assy. - (HZ - Arm)	
	63-2231	Main arm & link assy. - (HZA - Arm)	
	63-0641	Arm & bearing assy. (P10, CPS, PS, CPSH, PSH arms)	
	63-2607	Main arm & link assy. (O, O8, OZ, OZA, P3, P3A, P4A, P9, RP9 arms)	
	63-3727	Arm and bracket assy. (P10 arm)	
	63-3830	Arm and bracket assy. (CPS arm)	
	63-3833	Arm and bracket assy. (PSH arm)	
	63-3836	Arm and bracket assy. (CPSH arm)	
	63-3837	Arm and bracket assy. (PS arm)	
	63-2271	Foot assy- (P9, PR9 Arms)	
63-3493	Bumper only - (CPS, CPSH arms) use with 63-0516 Arm) -	Standard	
Program	Part #	Description	Finishes
1-Week, 2-Weeks	21-0198	1540 Jamb Bracket Shim	26D
	01-3436	Machine Screw	
	21-0104	590 Jamb Bracket Shim	
	01-3454	Machine Screw	

Door Control

Door Control

Door Closer and Overhead Holders & Stops Parts

Program	Part #	Description	Finishes
1-Week & 2-Week	125P9	Parallel Arm Foot	EB, EN, EAB, BSP
	125PH9	Parallel Arm Foot	
	125 P3	Arm Conversion Unit	EB, EN, EAB, EP, BSP
	125 P3A	Arm Conversion Unit	
	125P4	Arm Conversion	
	125 P4A	Arm Conversion Unit	
	281C	Closer Cover	EB, EN, EP, EAB, BSP
	351A	Mounting Plate	EB, EN, EAB, EP, BSP
	351B	Mounting Plate	
	351C	Closer Cover	B, EN, EP, EAB, BSP
	351D	Drop Bracket	EB, EN, EAB, EP, BSP
	1431D	Drop Bracket	
	281D	Mounting Plate	
	581-1	Blade Stop Spacer Kit (P9, PH9, PF9)	
	581-2	Blade Stop Spacer Kit (P10, PS, PSH, CPS, CPSH, PH10)	
	1431C	Closer Cover	EB, EN, EP, EAB, BSP
	4TB	Through-bolt Pack	EB, EN, EAB, EP, BSP
	Paint	Paint (One Color per 12 Unit Case)	EB, EN, EAB, ED, EP, BSP

Door Control

Electromagnetic Door Holders & Locks

Program	Part #	Description	Finish
1-Week, 2-Week	1560	Electromagnetic Door Holder - Wall Mount, Surface Applied	EN
	1561	Electromagnetic Door Holder - Concealed Wiring	
	1584	Electromagnetic Lock - Push Single door	32D

Exit Devices

8900 Series Device with Trim

8900 Series mortise lock exit device has concealed single point guarded latching for additional security and is designed for standard width stile applications on wood and metal doors.



B Lever

J Lever

L Lever

P Lever

MD Lever

ME Lever

MI Lever

MJ Lever

ND Lever

NJ Lever

REM Lever

ET **PTB Trim**

Program	Options	Functions	Rails	Escutcheon	Lever	Finishes
1-Week	12, 16, 43, 53, 55, 56, 60, 70, AL, KD, LC, SC, WS ²	8904, 8910, 8913, 8915, 8963, 8973 ¹ , 8974 ¹ , 8975 ¹ , 8976 ¹	F, G, J	ET, PTB, No Trim ³	B, J, L, P, MD, ME, MI, MJ, MV, ND, NJ, REM (32D Only)	10B, 10BE, 32D
2-Week					B, J, L, P, MD, ME, MG, MI, MJ, ND, NJ, REM (32D Only)	10B, 10BE, 32D, BSP

Cylinder Options

- 60 Disposable Construction Core
- 70 Interchangeable Core Disposable Plug
- KD Keyed Different
- LC Less Cylinder
- SC Schlage "C" Keyway

Mechanical Options

- 12 Fire Rated
- 16 Cylinder Dogging
- 43 Flush End Cap
- 53 Latchbolt Monitoring
- 55 Request-to-Exit
- 56 Electric Latch Retraction (ELR)
- AL Alarmed Exit
- WS^{2,4} Windstorm

Rail

- F 33" - 36" (84cm - 91cm)
(No cutting required for 36" (91 cm) door)
- G 43" - 48" (110cm - 122cm)
(No cutting required for 48" (122 cm) door)
- J 37" - 42" (94cm - 107cm)
(No cutting required for 42" (107cm) door)

Functions

- 8904 (ANSI 03) Key Retracts Latch with PSB or ET Trim
- 8910 (ANSI 01) Exit Only No Outside Trim
- 8910 (ANSI 02) Exit Only with PTB or ET Trim
- 8913 (ANSI 08) Key Locks/Unlocks with ET Trim
- 8915 (ANSI 14) Passage Only with ET Trim
- 8963 (ANSI 05) Key Locks/ Unlocks with PTB Trim
- 8973 Electrified ET Trim - Fail Safe, Power off, Unlocks Lever (No Cylinder)
- 8974 Electrified ET Trim - Fail Secure, Power off, Unlocks Lever (No Cylinder)
- 8975 Electrified ET Trim - Fail Safe. Power off, Unlocks Lever, Key retracts Latch
- 8976 Electrified ET Trim - Fail Secure. Power off, Unlocks Lever, Key retracts Latch

Finishes

- 10B Oxidized Dull Bronze
- 10BE Dark Oxidized Satin Bronze - Equivalent
- 32D Dull Stainless
- BSP Black Suede Powder Coat

Hand

- LHR Left Hand Reverse
- RHR Right Hand Reverse

Note: LA is the standard SARGENT keyway and all cylinders will be 1-bitted unless KD is specified. Cylinder dogging (16- option) is available with the 13 and 63 function devices only. 12- & 16- are not available together. ET trims are supplied in 26D in lieu of 32D. 1 Specify 12V or 24V when ordering solenoid operated ET Trim 2 WS is available for single hollow metal door applications for 1-3/4" thick doors, 3'0" x 7'0" max doors. 3 Available on 8910 only 4 WS8800 rails are only available in F Rail.

Exit Devices

8800 Series Device Only



The 8800 Series rim exit device is designed for standard width stile applications on wood and metal doors. This reversible rim exit device sets the industry standard for durability and reliability.

Program	Options	Functions	Rail Sizes	Finishes
24-Hour	12, 43	8888/8810	F	32D
1-Week	12, 16, 43, 60, 70, KD, LC, SC		F, G, J	10B, 10BE, 32D
2-Week				10B, 10BE, 32D, BSP

Cylinder Options

- 60 Disposable Construction Core
- 70 Interchangeable Core Disposable Plug
- KD Keyed Different
- LC Less Cylinder
- SC Schlage "C" Keyway

Mechanical Options

- 12 Fire Rated
- 16 Cylinder Dogging
- 43 Flush End Cap

Functions

8888/8810 Multifunction

Finishes

- 10B Oxidized Dull Bronze
- 10BE Dark Oxidized Satin Bronze - Equivalent
- 32D Dull Stainless
- BSP Black Suede Powder Coat

Rail

- F 33" - 36" (84cm - 91cm)
(No cutting required for 36" (91 cm) door)
- G 43" - 48" (110cm - 122cm)
(No cutting required for 48" (122 cm) door)
- J 37" - 42" (94cm - 107cm)
(No cutting required for 42" (107cm) door)

Hand

- LHR Left Hand Reverse
- RHR Right Hand Reverse

Note: LA is the standard SARGENT keyway and all cylinders will be 1-bitted unless KD is specified.

12 & 16 options are not available together

Cylinder options are available with 16 option devices only

Exit Devices

8800 Series Device with Trim

Exit
Devices

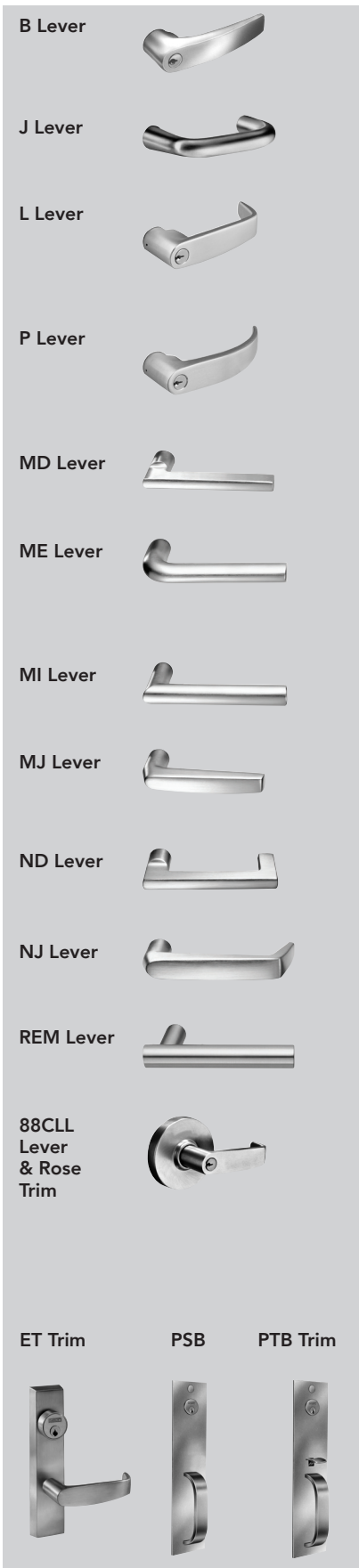

Program	Options	Functions	Rails	Escutcheon	Lever	Finishes
24-Hour	12, 43, 55, 56, KD	8813	F	ET, PSB+, PTB++ No Trim^	B, J, L, P, MD, ME, MI, MJ, MV, ND, NJ, REM, 88CLL	32D
1-Week	12, 16, 43, 53, 55, 56, 60, 70, HC, KD, LC, SC, WS*, 5CH~	8804, 8806, 8810, 8813, 8815, 8863, 8873*, 8874*, 8875*, 8876*, 8893	F, G, J			10B, 10BE, 32D
2-Week					B, J, L, P, MD, ME, MI, MJ, ND, NJ, REM, 88CLL	10B, 10BE, 32D, BSP

Cylinder Options

- 60 Disposable Construction Core
- 70 Interchangeable Core Disposable Plug
- KD Keyed Different
- LC Less Cylinder
- SC Schlage "C" Keyway

Mechanical Options

- 12 Fire Rated
- 16 Cylinder Dogging
- 43 Flush End Cap
- 53 Latchbolt Monitoring
- 55 Request-to-Exit
- 56 Electric Latch Retraction (ELR)
- HC Hurricane Code
- WS** Windstorm
- 5CH~ 5lb Pressure Release

Finishes

- 10B Oxidized Dull Bronze
- 10BE Dark Oxidized Satin Bronze - Equivalent
- 32D Dull Stainless
- BSP Black Suede Powder Coat

* Specify 12V or 24V when ordering solenoid operated ET Trim
 ** WS is available for single hollow metal door applications for 1-3/4" thick doors, 3'0" x 7'0" max doors.
 +Available with 04 function only
 ++Available with 10, 28, and 63 functions only
 ^Available on 8888/8810 only
 ~Consult factory if ordered with options 43, 55, 56

Functions

- 8804 (ANSI 03) Key Retracts Latch with PSB or ET Trim
- 8806 (ANSI 09) Key operates ET
- 8810 (ANSI 01) Exit Only, No Outside Trim
- 8810 (ANSI 02) Exit Only, with PTB or ET Trim
- 8813 (ANSI 08) Key Locks/Unlocks ET Trim
- 8815 (ANSI 14) Passage Only with ET Trim
- 8863 (ANSI 05) Key Locks/Unlocks PTB Thumb Piece
- 8873 Electrified ET Trim - Fail Safe, Power off, Unlocks Lever (No Cylinder)
- 8874 Electrified ET Trim - Fail Secure, Power off, Unlocks Lever (No Cylinder)
- 8875 Electrified ET Trim - Fail Safe. Power off, Unlocks Lever, Key retracts Latch
- 8876 Electrified ET Trim - Fail Secure. Power off, Unlocks Lever, Key retracts Latch
- 8893 Dummy Rail

Rail

- F 33" - 36" (84cm - 91cm)
(No cutting required for 36" (91 cm) door)
- G 43" - 48" (110cm - 122cm)
(No cutting required for 48" (122 cm) door)
- J 37" - 42" (94cm - 107cm)
(No cutting required for 42" (107cm) door)

Hand

- LHR Left Hand Reverse
- RHR Right Hand Reverse

Exit Devices

8800 Series Device - Trim Only



700 Series
ET Trim



814-PSB

Program	Options	Trim Functions	Escutcheon	Levers	Finishes
24-Hour	KD	713-8 ET	N/A	L	26D
1-Week	60, 70, KD, LC, SC,	704 ET, 710 ET, 713-8 ET, 715-8 ET, 773-8 ET, 774-8 ET, 775-8 ET, 776-8 ET	ET, 814-PSB No Trim^	B, J, L, P, MD, ME, MI, MJ, MV, ND, NJ, REM (32D only), 88CLL	10B, 10BE, 26D
2-Week		704 ET, 710 ET, 713-8 ET, 715-8 ET, 773-8 ET, 774-8 ET, 775-8 ET, 776-8 ET, 814-PSB, 88CLL		B, J, L, P, MD, ME, MG, MI, MJ, ND, NJ, REM (32D only), 88CLL	10B, 10BE, 26D, BSP

Cylinder Options

- 60 Disposable Construction Core
- 70 Interchangeable Core Disposable Plug
- KD Keyed Different
- LC Less Cylinder
- SC Schlage "C" Keyway

Functions

- 704ET Key Retracts Latch
- 710ET Pull Only No Cylinder
- 713-8ET Key Locks/Unlocks Lever
- 715-8ET Passage Only
- 773-8 ET Fail Safe Power Off, Unlocks Lever (No Cylinder)
- 774-8 ET Fail Secure Power Off, Locks Lever (No Cylinder)
- 775-8 ET Fail Safe Power Off, Unlocks Lever, Key Retracts Latched
- 776-8 ET Fail Secure Power Off, Locks Lever, Key Retracts Latch
- 88CLL Key Locks/Unlocks Trim
- 814-PSB Key Retracts Latchbolt (04 Function)

Finishes

- 10B Oxidized Dull Bronze
- 10BE Dark Oxidized Satin Bronze - Equivalent
- 26D Satin Chromium Plated Over Nickel
- BSP Black Suede Powder Coat

Hand

- LHR Left Hand Reverse
- RHR Right Hand Reverse

Voltage

- 12V
- 24V

B Lever



J Lever



L Lever



P Lever



MD Lever



ME Lever



MI Lever



MJ Lever



ND Lever



NJ Lever



REM Lever



88CLL
Lever
& Rose
Trim



Exit
Devices

Note: Electrified products have a total maximum quantity of 50 locks per order.
 LA is the standard SARGENT keyway and all cylinders will be 1-bitted unless KD is specified.
 710ET and 715-8ET are non cylinder functions.
 ^Available on 8888/8810 only

Exit Devices

8700 Series

The SARGENT 8700 Series Surface Vertical Rod Exit Device has two point latching (top and bottom of the door) and is adjustable through the center case.



8700 Surface Vertical Rod



NB8700 Top Latch Surface Vertical Rod



Program	Options	Functions	Rail	Escutcheon	Lever	Finishes
1-Week	12, 14, 16, 43, 53, 55, 56, 60, 70, KD, LC, NB, SC	8706, 8710, 8713, 8715, 8763, 8773, 8774	F, G, J	ET, PTB, No Trim*	B, J, L, P, MD, ME, MI, MJ, MV, ND, NJ, REM (32D only)	10B, 10BE, 32D
2-Week					B, J, L, P, MD, ME, MG, MI, MJ, ND, NJ, REM (32D only)	10B, 10BE, 32D, BSP

Cylinder Options

- 60 Disposable Construction Core
- 70 Interchangeable Core Disposable Plug
- KD Keyed Different
- LC Less Cylinder
- SC Schlage "C" Keyway

Options

- 12 Fire Rated
- 14 Solid Brass Bottom Bolt
- 16 Cylinder Dogging
- 43 Flush End Cap
- NB Less Bottom Bolt (Not available with PTB Trim)
- 53 Latchbolt Monitoring
- 55 Request to Exit
- 56 Electric Latch Retraction

Opening Height

(Center Line of Exit Device is 41" AFF)

- 84"
- 96"

Note: Electrified products have a total maximum quantity of 50 locks per order
 LA is the standard SARGENT keyway and all cylinders will be 1-bitted unless KD is specified.
 Cylinder options are available with 16- option; 06, 13, or 63 function only
 12 and 16 options are not available together
 14 option is not available with 12- or NB options
 12-NB applications require thermal pin. Thermal pin supplied when ordered as a 12-NB device.
 ET trims are supplied in 26D, in lieu of 32D
 * Available on 8710 only

Hand

- LHR Left Hand Reverse
- RHR Right Hand Reverse

Function

- 8706 (ANSI 09) Key allows Lever to Retract Bolts With ET Trim
- 8710 (ANSI 01) Exit Only No Outside Trim
- 8710 (ANSI 02) Exit Only with PTB or ET Trim
- 8713 (ANSI 08) Key Locks/Unlocks Trim with ET Trim
- 8715 (ANSI 14) Passage Only with ET Trim
- 8763 (ANSI 05) Key Locks/Unlocks PTB Trim
- 8773 Fail Safe
- 8774 Fail Secure

Finishes

- 10B Oxidized Dull Bronze
- 10BE Dark Oxidized Satin Bronze - Equivalent
- 32D Dull Stainless
- BSP Black Suede Powder Coat

Rail

- F 33" - 36" (84cm - 91cm)
(No cutting required for 36" (91 cm) door)
- G 43" - 48" (110cm - 122cm)
(No cutting required for 48" (122 cm) door)
- J 37" - 42" (94cm - 107cm)
(No cutting required for 42" (107cm) door)

Exit Devices

Exit Devices

AD8600 & MD8600 Series



The AD8600/NB-AD8600 and MD8600 Series are designed for standard width single or double aluminum or metal doors. The AD Series and the MD Series Concealed Rod Exit Devices meet ANSI/BHMA Grade 1 standards.

AD8600

Program	Options	Functions	Rail	Escutcheon	Lever	Finishes
1-Week	16, 43, 60, 70, KD, LC, NB, SC, AL,	AD8606, AD8610, AD8613, AD8615	F, G, J	ET, No Trim*	B, J, L, P, MD, ME, MI, MJ, MV, ND, NJ, REM (32D only)	10B, 10BE, 32D
2-Week	53, 55, 56, 5CH				B, J, L, P, MD, ME, MI, MJ, ND, NJ, REM (32D only)	10B, 10BE, 32D, BSP

MD8600

Program	Options	Functions	Rail	Escutcheon	Trims	Finishes
1-Week	12, 16, 43, 60, 70, KD, LC, NB, SC,	MD8606, MD8610, MD8613, MD8615, MD8673, MD8674	F, G, J	ET, No Trim*	B, J, L, P, MD, ME, MI, MJ, MV, ND, NJ, REM (32D only)	10B, 10BE, 32D
2-Week	AL, 53, 55, 56, 5CH				B, J, L, P, MD, ME, MI, MJ, ND, NJ, REM (32D only)	10B, 10BE, 32D, BSP

Cylinder Options

- 60 Disposable Construction Core
- 70 Interchangeable Core Disposable Plug
- KD Keyed Different
- LC Less Cylinder
- SC Schlage "C" Keyway

Options

- 12 Fire Rated
- 14 Solid Brass Bottom Bolt
- 16 Cylinder Dogging
- 43 Flush End Cap
- NB Less Bottom Bolt
- AL Alarmed Exit
- 53 Latchbolt Monitoring
- 55 Request to Exit
- 56 Electric Latch Retraction
- 5CH 5lb. Pressure Release

Rail

- F 33" - 36" (84cm - 91cm)
(No cutting required for 36" (91 cm) door)
- G 43" - 48" (110cm - 122cm)
(No cutting required for 48" (122 cm) door)
- J 37" - 42" (94cm - 107cm)
(No cutting required for 42" (107cm) door)

Opening Height

(Center Line of Exit Device is 41" AFF)

- 84"
- 96"

Hand

- LHR Left Hand Reverse
- RHR Right Hand Reverse

Function

- AD/MD8606 (ANSI 09) Key allows Lever to Retract Bolts with ET Trim
- AD/MD8610 (ANSI 01) Exit Only, No Outside Trim
- AD/MD8610 (ANSI 02) Exit Only with ET Trim
- AD/MD8613 (ANSI 08) Key Locks/Unlocks Trim with ET Trim
- AD/MD8615 (ANSI 14) Passage Only with ET Trim
- MD8673 Electrified ET Trim - Fail Safe Power Off, Unlocks Lever (No Cylinder)
- MD8674 Electrified ET Trim - Fail Secure Power Off, Locks Lever (No Cylinder)

Finishes

- 10B Oxidized Dull Bronze
- 10BE Dark Oxidized Satin Bronze - Equivalent to 10B
- 32D Dull Stainless Steel
- BSP Black Satin Powder Coat

Note: Electrified products have a total maximum of 200V and 0.5A per order. BSP the Black Satin Powder Coat and all cylinders will be 1-bitted unless KD is specified.

Cylinder options are available with 16- option; 06 or 13 function only

12 and 16 options are not available together

12-NB applications require thermal pin. Thermal pin supplied when ordered as a 12-NB device.

ET trims are supplied in 26D, in lieu of 32D

* Available on AD8610 & MD8610 only

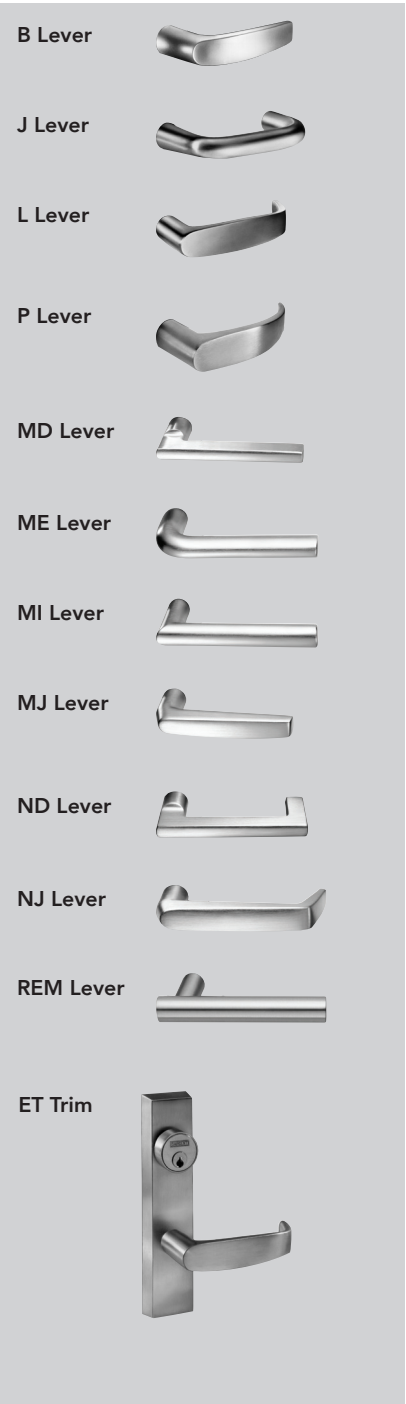

Exit Devices

Exit Devices

8500 & AD8500 Series

The 8500 Series Narrow Design Rim Exit Device is designed for narrow stile applications and features a rim bolt for quiet operation and security.



B Lever



J Lever



L Lever



P Lever



MD Lever



ME Lever



MI Lever



MJ Lever



ND Lever



NJ Lever



REM Lever



ET Trim



Exit Devices

Program	Options	Functions	Rail	Escutcheon	Lever	Finishes
1-Week	12, 16, 43, 60, 70, KD, LC, SC, AL, 53, 55, 56, 5CH	8504, 8510, 8513, 8573, 8574, AD8504, AD8510, AD8513	F, G, J	ET, No Trim*	B, J, L, P, MD, ME, MI, MJ, MV, ND, NJ, REM (32D only)	10B, 10BE, 32D
2-Week					B, J, L, P, MD, ME, MI, MJ, ND, NJ, REM (32D only)	10B, 10BE, 32D, BSP

Cylinder Options

- 60 Disposable Construction Core
- 70 Interchangeable Core Disposable Plug
- KD Keyed Different
- LC Less Cylinder
- SC Schlage "C" Keyway

Mechanical Options

- 12 Fire Rated
- 16 Cylinder Dogging
- 43 Flush End Cap
- AL Alarmed Exit
- 53 Latchbolt Monitoring
- 55 Request to Exit
- 56 Electric Latch Retraction
- 5CH 5lb. Pressure Release

Hand

- LHR Left Hand Reverse
- RHR Right Hand Reverse

Rail

- F 33" - 36" (84cm - 91cm)
(No cutting required for 36" (91 cm) door)
- G 43" - 48" (110cm - 122cm)
(No cutting required for 48" (122 cm) door)
- J 37" - 42" (94cm - 107cm)
(No cutting required for 42" (107cm) door)

Exit x Function

- 8504 (ANSI 03) Key allows Lever to Retract Bolts With ET Trim
- 8510 (ANSI 01) Exit Only No Outside Trim
- 8510 (ANSI 02) Exit Only with ET Trim
- 8513 (ANSI 08) Key Locks/Unlocks Trim with ET Trim
- 8573 Electrified ET Trim - Fail Safe Power Off, Unlocks Lever (No Cylinder)
- 8574 Electrified ET Trim - Fail Secure Power Off, Locks Lever (No Cylinder)

Finishes

- 10B Oxidized Dull Bronze
 - 10BE Dark Oxidized Satin Bronze
- Note: Electrified products have a total maximum quantity of 5000 per order

32D Dull Stainless Steel keyway and all cylinders will be supplied with a Black Super Powder Coat. Cylinder options are available with 16- option; 04 or 13 function only

ET trims are supplied in 26D, in lieu of 32D

* Available on 8510 and AD8510 only

Exit Devices

AD8400/MD8400 Series



The AD8400 and MD8400 Series are designed for narrow width single or double aluminum or metal doors. The AD Series and the MD Series Concealed Rod Exit Devices meet ANSI/BHMA Grade 1 standards.

Program	Options	Exit Device	Rail	Trims	Finishes
1-Week	16, 43, 60, 70, KD, LC, NB, SC, AL, 12-MD, 53, 55, 56, 5CH	AD8410, MD8410	F, G, J	106 x 862 Pull, 862 Pull, No Trim	10BE, 10B, 32D
2-Week					10B, 10BE, 32D, BSP

Cylinder Options

- 60 Disposable Construction Core
- 70 Interchangeable Core Disposable Plug
- KD Keyed Different
- LC Less Cylinder
- SC Schlage "C" Keyway

Mechanical Options

- 16 Cylinder Dogging
- 43 Flush End Cap
- NB Less Bottom Bolt
- AL Alarmed Exit
- 53 Latchbolt Monitoring
- 55 Request to Exit
- 56 Electric Latch Retraction
- 5CH 5lb. Pressure Release

Hand

- LHR Left Hand Reverse
- RHR Right Hand Reverse

Opening Height

(Center Line of Exit Device is 41" AFF)

- 84"
- 96"

Note: Electrified products have a total maximum quantity of 50 locks per order

LA is the standard SARGENT keyway and all cylinders will be 1-bitted unless KD is specified.

Trims

- 106 Aux Control x 862 Pull (ANSI 12)
Key allows Turn to Retract Bolts
- 862 Pull (ANSI 02) Pull Only,
No O/S Operation
- No Trim Exit Only (ANSI 01)

Finishes

- 10B Oxidized Bronze, Oil-Rubbed
- 10BE Dark Oxidized Satin Bronze - Equivalent
- 32D Satin Stainless Steel
- BSP Black Suede Powder Coat

Rail

- F 33" - 36" (84cm - 91cm)
(No cutting required for 36" (91 cm) door)
- G 43" - 48" (110cm - 122cm)
(No cutting required for 48" (122 cm) door)
- J 37" - 42" (94cm - 107cm)
(No cutting required for 42" (107cm) door)

Cylinder options are available with 16- option or 106 Aux Control only

12-NB applications require thermal pin. Thermal pin supplied when ordered as a 12-NB device.

106 Auxiliary Control



862 Pull

Exit Devices

90 Series Exit Device

The 90 Series cross bar exit device is for single door and pairs of doors where a narrow stile application is required.



PTB



Exit
Devices

Program	Options	Trim/Function	Finishes
24-Hour	KD	814-PTB, 810-PTB, 866-PTB	32D
1-Week	KD, SC, 60, 70, LC		
2-Week			10, 32D

Program	Function	Finishes
24-Hour	9898	32D
1-Week		
2-Week		10, 32D

Cylinder Options

- 60 Disposable Construction Core
- 70 Interchangeable Core Disposable Plug
- KD Keyed Different
- LC Less Cylinder
- SC Schlage "C" Keyway

Finishes

- 10 Dull Bronze
- 26D Satin Chrome

Device

- 9898 Multifunction Rim Crossbar*

Hand

- LHR Left Hand Reverse
- RHR Right Hand Reverse

Trim Function

- 814-PTB Trim 04 (ANSI 03) Night Latch Key Retracts Latch
- 810-PTB Pull 10 (ANSI 02) Dummy Trim No O/S Operation Pull Only
- 866-PTB Trim 63 (ANSI 05) Entry Lock Key Locks/Unlocks Thumb Piece

Note: LA is the standard SARGENT keyway and all cylinders will be 1-bitted unless KD is specified

* Device supplied for up to 44" wide doors

Exit Devices

30 Series Exit Device

The 3727 and 3828 Series are rugged exit devices in a surface vertical rod and rim design with 4 available trims and is easy to mix and match the device and trim.

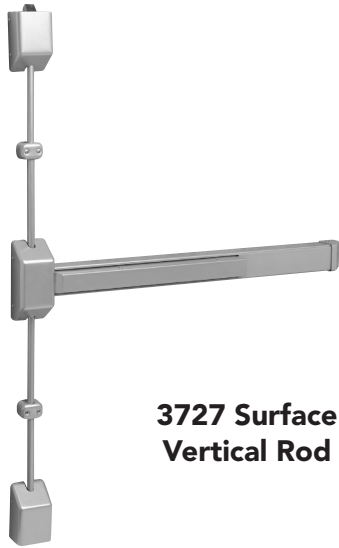

3727 Surface Vertical Rod



3828 Rim Exit Device

Program	Options	Exit Device	Rail	Finishes
24-Hour	-	3828	F	EN
1-Week	12-	3828, 3727	F, G, J	EB, EN

Cylinder Options

- 12 Fire Rated
- 21 Construction Keying (Lost Ball)
- KD Keyed Different
- LC Less Cylinder
- SC Schlage "C" Keyway

Function

- 3828 Rim
- 3827 Surface Vertical Rod

Hand

- LHR Left Hand Reverse
- RHR Right Hand Reverse

Finishes

- EB Bronze Enamel
- EN Aluminum Enamel

Opening Height

(Center Line of Exit Device is 41" AFF)

- 84"
- 96"

Rail

- F 33" - 36" (84cm - 91cm)
(No cutting required for 36" (91 cm) door)
- G 43" - 48" (110cm - 122cm)
(No cutting required for 48" (122 cm) door)
- J 37" - 42" (94cm - 107cm)
(No cutting required for 42" (107cm) door)

Note:

12 and 16 options are not available together
 LA is the standard SARGENT keyway and all cylinders will be 1-bitted unless KD is specified

Exit Devices

30 Series Trim

The 3727 and 3828 Series are rugged exit devices in a surface vertical rod and rim design with 4 available trims and is easy to mix and match the device and trim.

Program	Options	Trim	Finishes
24-Hour	KD	28CLL, 28COB, 814HTB	32D, EN
1-Week	KD, LC, SC		10B, 10BE, 32D, EB, EN, BSP

Cylinder Options

- KD Keyed Different
- LC Less Cylinder
- SC Schlage "C" Keyway

Finishes

- 10B Oxidized Dull Bronze
- 10BE Dark Oxidized Satin Bronze - Equivalent
- 32D Brushed Stainless Steel
- EB Bronze Enamel to match 10B (814 HTB only)
- EN Aluminum Enamel (814HTB only)
- BSP Black Suede Powder Coat

Function

- 28CLL 13 Function
- 28COB 13 Function (Key locks/unlocks knob)
- 814HTB 04 Function (Key retracts latch)

Note:

814HTB (EB & EN only) for 3828 only

28CLL



28COB



814HTB



Exit Devices

5300 Series



Designed for areas requiring a standalone alarm on outward swinging doors, the 5300 Series has an integrated, immediate sounding alarm in the push rail to discourage unauthorized use of exit doors.

5300 Series Exit Device

Program	Option	Exit Device/ Exit Alarm	Rail Size	Exit Finish
2-Week	12-	5304, 5310, 5313, 5315	E, F, J & G	EB, EN, ERD, 32D, BSP

Options

12 Fire Rated

Finishes

EN Aluminum Enamel to Match US28
 EB Bronze Enamel to Match US10B
 ERD Polyester Powder Coat - Red
 32D Brushed Stainless Steel
 BSP Black Suede Powder Coat

Rail

E 32" only
 F 33" - 36" (84cm - 91cm)
 G 43" - 48" (110cm - 122cm)
 J 37" - 42" (94cm - 107cm)

Trim

28-C-LL 13 Function
 28-D-LL 10 Function
 28-K-LL 04 Function
 28-L-LL 15 Function
 53 K HTB 04 Function
 53 E GTB 10 Function - Exit Only
 53 D GTB 10 Function - Pull

Functions

04 (ANSI 03) Night Latch Key Retracts Latch
 10 (ANSI 02) Dummy Trim No Outside Operation
 13 (ANSI 08) Entrance Lock Key Locks/Unlocks Trim
 15 Passage Only

Hand

RHR Right Hand Reverse
 LHR Left Hand Reverse
 Note: All finished products have a total maximum quantity of 50 locks per order



53 K HTB



53 D GTB



53 E GTB



Exit Devices

Exit Devices

5300 Series Trim

Designed for areas requiring a standalone alarm on outward swinging doors, the 5300 Series has an integrated, immediate sounding alarm in the push rail to discourage unauthorized use of exit doors.

Trim for 5300 Series Exit Alarm

Program	Function	Trim	Trim Finish
2-Week	04, 10, 13, 15	88-C-LL, 88-D-LL, 88-K-LL, 88-L-LL, 53 K HTB, 53 D GTB, 53 E GTB	EB, EN, ERD, 32D, BSP

Finishes

EN	Aluminum Enamel to Match US28
EB	Bronze Enamel to Match US10B
ERD	Polyester Powder Coat - Red
32D	Brushed Stainless Steel
BSP	Black Suede Powder Coat

Trim

28-C-LL	13 Function
28-D-LL	10 Function
28-K-LL	04 Function
28-L-LL	15 Function
53 K HTB	04 Function
53 E GTB	10 Function - Exit Only
53 D GTB	10 Function - Pull



53 K HTB



53 D GTB



53 E GTB



Exit Devices

7000 Series



The 7000 is perfect for a wide variety of applications including conference rooms, commercial office buildings, convention centers, upscale condominiums, medical and educational institutions where exit devices are not required.

Program	Options	Exit Device	Escutcheon	Lever	Finishes
1-Week	60, 70, KD, LC	700615, 701015, 701313, 701315, 701515, 707415	ET	B, J, L, P, MD, ME, MI, MJ, MV, ND, NJ, REM (32D only)	26D, BSP
2-Week				B, J, L, P, MD, ME, MI, MJ, ND, NJ, REM (32D only)	

Options

- 60 Disposable Construction Core
- 70 Interchangeable Core Disposable Plug
- KD Keyed Different
- LC Less Cylinder

Finishes

- 26D Satin Chrome
- BSP Black Suede Powder Coat

Opening Height

(Center Line of Exit Device is 41" AFF)

- 84"
- 96"

Functions

- 700615 Key unlocks Trim; Trim retracts latch; Trim relocks when key is removed
- 701015 No outside Operation (No Cylinder); Pull Only
- 701313 Class Room Key Outside Unlocks/locks Trim; #41 Cylinder Supplied
- 701315 Class Room Key Outside Unlocks/locks Trim; #41 Cylinder Supplied
- 701515 Passage only (No cylinder)
- 707415 Electrified Trim - Fail Secure

Hand

- RHR Right Hand Reverse
- LHR Left Hand Reverse

Note: Maximum quantity of 25 units per order

B Lever



J Lever



L Lever



P Lever



MD Lever



ME Lever



MI Lever



MJ Lever



ND Lever



NJ Lever



REM Lever



ET Trim



Exit Devices

80 Series Parts

Exit
Devices

Program	Part #	Description	Finishes	
24-Hour, 1-Week & 2-Week	01-0098	Retaining Clip	Standard	
	01-0610	Wave Spring Washer		
	68-0405	8700 Chassis Cover	10B, 32D, BSP	
	68-0406	8800 Chassis Cover		
	68-0407	8600 & 8900 Chassis Cover		
	68-0561	Plastic End Cap	Black	
	68-2279	Through-bolt Pack - Rail & Chassis (86,87,88,89)	10B, 26D, BSP	
	68-2282	Through-bolt Pack - Cases & Guides (87)		
	68-2288	Through-bolt Pack - 12-8700	Standard	
	68-2596	Hex Key Dogging Kit		
	68-2695	F Rail Assembly - Wide		
	68-2696	G Rail Assembly - Wide		
	68-2697	J Rail Assembly - Wide		
	68-2703	12- F Rail Assembly - Wide		
	68-2704	12-G Rail Assembly - Wide		
	68-2705	12-J Rail Assembly - Wide		
	68-3023	Screw Pack 12-8700		
	68-3671	ET Spindle Adapters (Square spindle to cross shaped -8)		
	94-2050	Top Retainer		EB/EN
	94-2051	Bottom Retainer		
	97-0001	Hex Dogging Key	Standard	
	97-0020	Rod Guides		
	97-0052	End Cap Screws (Cover)		
	97-0349	16-Collar (for rail Lockdown)	26D	
	98-2190	Top Retainer Pack(980S)	N/A	
	98-2191	Bottom Retainer Pack (980S)		
	98-2525	Bottom Retainer Pack (L980)		
	98-2526	Top Retainer Pack (L980)		
	98-2556	Bottom Retainer Pack (L980S)		
	98-2559	Top Retainer Pack (L980S)		
	98-2578	Wall Mount Kit (L980)		10B
	98-2579	Wall Mounting Kit (L980S)		N/A
	98-2594	Bottom Retainer Pack (HCL980)		
98-2599	Tom Retainer Pack(HC980, 12-HC980, 12-HCL980)			
98-2600	Bottom Retainer Pack (HC980, 12-HC980, 12-HCL980)			
502	Bottom Retainer (980)			
511	Top Retainer (980)			
565	Metal End Cap Kit	32D		

Program	Part #	Description	Finishes
24-Hour, 1-Week & 2-Week	571-12	12" Rod Ext . Kit for 9700/2700/8700 (mfg prior 11/02)	10B, 32D, BSP
	571-18	18" Rod Ext . Kit for 9700/2727/8700 (mfg prior 11/02)	
	571-6	6" Rod Ext . Kit for 9700/2700/8700 (mfg prior 11/02)	
	601	Top Retainer Shim Kit (HC980, 980S, 12-HC980, L980S, HCL980, 12-HCL980)	N/A
	644	Strike - Surface or Double door strike for 2828 & 8800	Black Nylon
	649	Strike - Standard for 12-2828, 12-5800, 12-8800, 12-9800	
	650	Top Strike	
	665	Flush End Cap	32D
	687-12	Top Rod for 8700 41" AFF - 96" Door (new style 8700's), PP/PR/SP8700	10B, 32D, BSP
	687-18	Top Rod for 8700 41" AFF - 102" Door (new style 8700's), PP/PR/SP8700	
	687-6	Top Rod for 8700 41" AFF - 90" Door (new style 8700's), PP/PR/SP8700	
	809	Lexan Touchpad Kit	Black
	815	Open Back Strike - LHR	Black Nylon
	815	Open Back Strike - RHR	
	980C1	Cylinder Kit (L980S, HCL980)	10B, 26D

Program	Part #	Description	Finishes
1-Week & 2-Week	97-0579	Holdback Spring for Top Case	Standard
	576	12-Bottom Pullman Bolt Conversion Kit (8700)	Standard
	587	Shim Kit (8700)	EN
	589	Shim Kit (8800, 12-8800, 8910 & 12-8910 Function)	
	730-1	700 Series Spindle Kit - 1-3/4" Door	Standard
	730-2	700 Series Spindle Kit - 2" Door	
	730-3	700 Series Spindle Kit - 2-1/4" Door	
	730-7	700-8 Series Spindle Kit - 1-3/4" Door	
	730-8	700-8 Series Spindle Kit - 2" Door	
	730-9	700-8 Series Spindle Kit - 2-1/4" Door	
	816-1	Cylinder Dogging Kits - w/ Wide Stile F size rail	10B, 32D, BSP
	816-2	Cylinder Dogging Kits - w/ Narrow Stile E, F size rail	
	816-3	Cylinder Dogging Kits - w/ Wide Stile G size rail	

Exit Devices

90 Series & 30 Series Parts

90 Series

Program	Part #	Description	Finishes
24-Hour, 1-Week & 2-Week	97-0020	Rod Guides	10B, 32D
	98-2159	Bolt Spring & Bracket Assembly	Standard

30 Series

Program	Part #	Description	Finishes
24-Hour, 1-Week & 2-Week	28-2024	3828 TB Pack	10B or 26D
	28-2031	3727 TB Pack	

Exit Devices

Electromechanical Parts & Accessories

Miscellaneous Accessories

Program	Part #	Description	Finish
24-Hour, 1-Week, 2-Week	807	TL- SARGuide Lamp Repl. Kit	N/A
	32-7044	Tamper Switch & Bracket Assembly for 5100/5800	
	3287	Door Position SPDT Switch (Concealed)	
	547	Retrofit Kit to cover Unican Prep (10L)	26D

12 & 24 Volt Power Supplies

Program	Part #	Description
24-Hour, 1-Week, 2-Week	LSP-12-24	12V - 6AMP / 24V - 3AMP Power Supply
	737	12VDC-5 Amp Hour Battery Backup
	738	24VDC-5 Amp Hour Battery Backup
	TMR2	Multi-Function Timer 12 or 24 VDC/VAC
	TMR9	Release Hold Timer
1-Week & 2-Week	LSP-12-24	12V - 6AMP / 24V - 3AMP Power Supply

55- Request to Exit Insert Kits

Program	Part #	Description	Finish
24-Hour, 1-Week, 2-Week	855	Universal Retrofit Kit	N/A

59- Delayed Egress Accessories

Program	Part #	Description	Finish
	52-2204	Latchbolt Switch Assembly for 59-8500/59-8800	N/A
	52-5052	Electroguard Circuit Board Replacement Kit (59-)	
	68-3784	Rail Assembly for wide stile 12-59-80 Series (F)	

Exit Devices

Electromechanical Parts & Accessories

56-Electric Latch Retraction Rails & Accessories

Program	Part #	Description	Finish
24-Hour, 1-Week, 2-Week	68-0807	56-80 Series ELR Lift Lever for Devices mfg prior to 2007	N/A
	68-3211	56- Rail Assembly for 80 Series - Wide Stile - 43"-48" (G)	32D
	68-3212	56- Rail Assembly for 80 Series - Wide Stile - 33"-36" (F)	
	68-3213	56- Rail Assembly for 80 Series - Wide Stile - 37"-42" (J)	
	68-3216	56- Rail Assembly for 80 Series - Narrow Stile 43"-48" (G)	
	68-3217	56- Rail Assembly for 80 Series - Narrow Stile 33"-36" (F)	
	68-3218	56- Rail Assembly for 80 Series - Narrow Stile 37"-42" (J)	

Availability: 56-Electric Latch Retract Push Kits

Program	Options	Push Kit	Rail Size	Finishes
24-Hour	-	M56A, R56A	F	32D
1-Week & 2-Week	19-, 55-, HK-	M56A, M56B, R56A, R56B	F, J & G	03, 10, 10B, 32D

Auxiliary Locks

4870 Series Mortise Deadbolt

The SARGENT 4870 Series Deadbolt is a heavy duty deadbolt that assures safety and security.

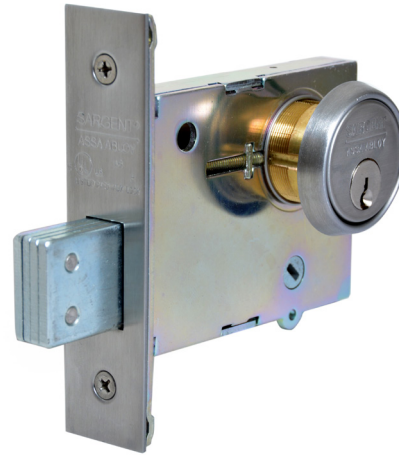

4870 Series

Program	Options	Functions	Finishes
24-Hour	KD	4875	26D
1-Week 2-Week	KD, SC, 60, 70, LC	4874, 4875, 4877	03, 10, 10B, 10BE, 26, 26D, BSP

Functions

- 4874 Cylinders O/S & I/S
- 4875 Cylinder O/S & Thumb Turn I/S
- 4877 Cylinder O/S & Thumb Turn I/S;
Thumb Turn retracts Deadbolt only

Cylinder Options

- KD Keyed Different
- SC Schlage "C" Keyway
- 60 Disposable Construction Core
- 70 Interchangeable Core Disposable Plug
- LC Less Cylinder

Finishes

- 03 Bright Brass
- 10 Dull Bronze
- 10B Oxidized Dull Bronze
- 10BE Dark Oxidized Satin Bronze -
Equivalent
- 26 Bright Chrome
- 26D Satin Chrome
- BSP Black Suede Powder Coat

Auxiliary Locks

460 & 480 Series Cylindrical Deadbolt

The 460 Series is a medium grade cylindrical deadbolt that is ANSI/BHMA A156.36 1000 Series Grade 2 certified.

The 480 Series is a high grade cylindrical deadbolt that is ANSI/BHMA A156.36 1000 Series Grade 1 certified.



460 Line



480 Line

460 Line

Program	Options	Functions	Finishes
24-Hour	KD	464, 465, 468	26D
1-Week, 2-Week	KD, SC		03, 10B, 10BE, 26D

480 Line

Program	Options	Functions	Finishes
1-Week, 2-Week	KD, SC, 20, 60, 70, LC	484, 485, 487, 489	03, 10, 10B, 10BE, 26D

Cylinder Options

- KD Keyed Different
- SC Schlage "C" Keyway
- 60 Disposable Construction Core
- 70 Interchangeable Core Disposable Plug
- LC Less Cylinder

Options

- 20 for 2-3/8" 160 prep

Functions

- 464 Double Cylinder
- 465 Single Cylinder
- 468 Thumb Turn x Indicator
- 484 Cylinders O/S & I/S
- 485 Cylinder O/S & Thumb Turn I/S
- 487 Cylinder O/S & Thumb Turn I/S; Thumb Turn retracts Deadbolt only
- 489 Turn Lever I/S & Blank Plate O/S

Finishes

- 03 Bright Brass
- 10 Dull Bronze
- 10B Oxidized Dull Bronze
- 10BE Dark Oxidized Satin Bronze Equivalent
- 26D Satin Chrome

Auxiliary Locks

758 & 858 Series Padlocks

The 758 padlock is manufactured to the highest quality standard and is available with multiple keyways, allowing use into master keyed systems (6 pin cylinder standard).



758, 858 Series

Program	Options	Functions
1-Week, 2-Week	KD, 60	758, 858

Functions

- 758 Key retaining. Key removable in locked position only
- 858 Non key retaining. Key can be removed while unlocked and relocked without key

Cylinder Options

- KD Keyed Different
- SC Schlage "C" Keyway

Auxiliary Locks

Auxiliary Parts

480 Line Parts

Program	Part #	Description	Finishes
1-Week, 2-Week	16-2153	Deadbolt Assembly - 2-3/8" BS	03, 04, 10, 10B, 32D
	16-2149	Deadbolt Assembly - 2-3/4" BS	
	16-2201	Screw Packs - 484	03, 04, 10, 10B, 26D
	16-2202	Screw Packs - 485, 486, 487	03, 10, 10B, 26D
	16-2203	Screw Packs - 489	
	16-2039	T-Turns-Inside - 485, 489	03, 26D
	16-2179	T-Turns-Inside - 487	
	16-2460	Dummy Plates-Outside - 489	03, 10, 10B, 26D

Access Control Keypad Operated Products

KP Technology

SARGENT

ASSA ABLOY

www.sargentlock.com

The KP Series Keypad locks are designed for openings that require standalone, basic authorized entry capabilities. They are battery powered, motor driven, self contained locks that use a microprocessor based controller with non-volatile memory. All programming is done at the door using the keypad with functions selected by the user according to opening requirements.



B Lever



L Lever



P Lever



G Rose
(10X Line Only)



L Rose
(10X Line Only)



LN Rose



ET Trim



Program	Options	Functions	Trim	Lever	Finishes
1-Week, 2-Week	60, 70, KD, LC	KP-10XG77	G, L	B, L, P	26D

Program	Options	Functions	Trim	Lever	Finishes
1-Week, 2-Week	60, 70, KD, LC	KP-8276, KP-8278	LN	B, J, L, P	26D

Program	Options	Functions	Rail Size	Trim	Lever	Finishes
1-Week, 2-Week	60, 70, KD, LC	KP-8877	F	ET	B, J, L, P	32D

Cylinder Options

KD	Keyed Different
60	Disposable Construction Core
70	Interchangeable Core Disposable Plug
LC	Less Cylinder

Finishes

26D	Satin Chrome
32D	Satin Stainless Steel

Functions

KP-10XG77	Cylinder override
KP-8276	Cylinder override and deadbolt
KP-8278	Cylinder override and no deadbolt
KP-8877	Deadbolt and no cylinder override

Rail

F	33" - 36" (84cm - 91cm)
---	-------------------------

Note: Electrified products have a total maximum quantity of 50 locks per order

Access
Control

Access Control Keypad Operated Products

Electromechanical Parts and Accessories

SARGENT

ASSA ABLOY

www.sargentlock.com

Switches, Keypads, Key Switches & Readers

Program	Part #	Description	Finish
1-Week, 2-Week	4370	One SPDT Maintain Key Switch	32D
	4371LT	One SPDT, w/2 LED's & Adjustable Time, Momentary Key Switch	
	4375LH	Two SPDT, 2 LED'S, 1 Horn, Momentary Key Switch	

Keypad Assemblies & Controllers

Program	Part #	Description	Finish
24-Hour, 1-Week, 2-Week	52-2299	Keypad Assembly for KP10XG77, KP8200, KP8800, KP8900	N/A
	52-6085 - KP	Universal Controller	

The ASSA ABLOY Group is the global leader in access solutions. Every day, we help billions of people experience a more open world.

ASSA ABLOY Opening Solutions leads the development within door openings and products for access solutions in homes, businesses and institutions. Our offering includes doors, frames, door and window hardware, mechanical and smart locks, access control and service.

SARGENT[®]

ASSA ABLOY

SARGENT Manufacturing Company
100 Sargent Drive
New Haven, CT 06511 USA
800-727-5477
www.sargentlock.com

Founded in the early 1800s, SARGENT[®] is a market leader in locksets, cylinders, door closers, exit devices, electro-mechanical products and access control systems for new construction, renovation, and replacement applications. The company's customer base includes commercial construction, institutional, and industrial markets.

Copyright © 2007-2026, SARGENT Manufacturing Company. All rights reserved. Reproduction in whole or in part without the express written permission of SARGENT Manufacturing Company is prohibited. Patent pending and/or patent www.assaabloydss.com/patents.