

# 2100 SERIES

## Economy Exit Devices



## TABLE OF CONTENTS

### Contents

<a href="#">Introduction</a>	<a href="#">3</a>
<a href="#">Benefits &amp; Features</a>	<a href="#">4</a>
<a href="#">Finishes</a>	<a href="#">5</a>
<a href="#">How to Order</a>	<a href="#">6</a>
<a href="#">2100(F) Rim</a>	<a href="#">7</a>
<a href="#">2150(F) SquareBolt®</a>	<a href="#">8</a>
<a href="#">2110(F) Surface Vertical Rod</a>	<a href="#">9</a>
<a href="#">2170(F) Surface Vertical Rod</a>	<a href="#">10</a>
<a href="#">2120(F) Concealed Vertical Rod</a>	<a href="#">11</a>
<a href="#">2160(F) Concealed Vertical Rod</a>	<a href="#">12</a>
<a href="#">Trim Designs</a>	<a href="#">13-21</a>
<a href="#">Functions</a>	<a href="#">22</a>
<a href="#">Applications</a>	<a href="#">23-24</a>
<a href="#">Electrified Options</a>	<a href="#">25</a>
<a href="#">Cylinders</a>	<a href="#">26-28</a>
<a href="#">Collars &amp; Tailpieces</a>	<a href="#">29</a>
<a href="#">Strikes</a>	<a href="#">30</a>
<a href="#">Accessories &amp; Options</a>	<a href="#">31</a>
<a href="#">Mullions</a>	<a href="#">32-34</a>
<a href="#">Dimensions</a>	<a href="#">35</a>
<a href="#">Sample Specification</a>	<a href="#">36</a>
<a href="#">Technical Specifications &amp; Listings</a>	<a href="#">37</a>

### 2100 Economy Exit Device

With a combination of sturdy construction and innovative security features, it's easy to see why building owners and architects alike prefer the 2100 Series Exit Device for all their economy applications. The quality and certified ANSI/BHMA Grade 1 performance ensures strength and reliability wherever this device is installed. Available in a wide range of both standard and architectural finishes, the 2100 Series is a perfect fit for both back of house and prominent openings in office buildings, retail and a long list of other facilities that require both performance and style.









### **WARNING**

This product can expose you to lead which is known to the state of California to cause cancer and birth defects or other reproductive harm. For more information go to [www.P65warnings.ca.gov](http://www.P65warnings.ca.gov).

## INTRODUCTION

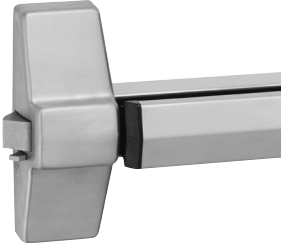
ASSA ABLOY ACCENTRA® offers innovative and reliable products to solve the challenges of commercial, retail, hospitality, assisted living, mixed-use, and multi-family properties. Our door hardware expertise extends beyond products to people - and provides the service and support you expect.

Featuring durable products to meet all your facilities' requirements - and the quality you expect from a leader in the hardware industry.

ASSA ABLOY ACCENTRA® Exit Devices			
7000 Series	6000 Series	1800 Series	1500 Series
			
			
<ul style="list-style-type: none"> <li>• Ideal for facilities that require durability and innovation to meet their security needs</li> <li>• Wide &amp; Narrow Stile Applications</li> <li>• Rim, SquareBolt, Mortise, SVR &amp; CVR</li> <li>• Mechanical &amp; Electro-Mechanical Functions</li> <li>• Available with Motorized Electric Latch Retraction</li> <li>• Constructed with high quality steel and heavy-duty components</li> <li>• 16 Standard finishes including BSP (Black Suede Powder Coat)</li> <li>• ANSI/BHMA Certified Grade 1</li> <li>• UL Rated for Panic &amp; Fire, Windstorm Rated Options (refer to local codes)</li> <li>• 5 Year Warranty and Two-Year Limited Warranty on Electronic Components</li> </ul>	<ul style="list-style-type: none"> <li>• Ideal for facilities that require modern form and full functionality to meet their life safety needs</li> <li>• Wide &amp; Narrow Stile Applications</li> <li>• Rim, Squarebolt, CVR, SVR &amp; Mortise</li> <li>• Mechanical &amp; Electro-Mechanical Functions</li> <li>• Available with Motorized Electric Latch Retraction</li> <li>• Aluminum rail assembly with Architectural Metals</li> <li>• Solid Cast Flush End Cap</li> <li>• ANSI/BHMA Certified Grade 1</li> <li>• UL Rated for Panic &amp; Fire</li> <li>• 10 Year Warranty and Two-Year Limited Warranty on Electronic Components</li> </ul>	<ul style="list-style-type: none"> <li>• Ideal for back of the house where function and code compliance are the requirement</li> <li>• Wide Stile Applications</li> <li>• Rim &amp; SVR</li> <li>• Mechanical Functions</li> <li>• ANSI/BHMA Certified Grade 1</li> <li>• UL Rated for Panic &amp; Fire</li> <li>• Powder-coat Painted Finishes</li> <li>• 3 Year Warranty</li> </ul>	<ul style="list-style-type: none"> <li>• Ideal for renovation projects where historical preservation is the desired look</li> <li>• Wide Stile Applications</li> <li>• Rim, CVR, SVR &amp; Mortise</li> <li>• ANSI/BHMA Certified Grade 1</li> <li>• UL Rated for Panic &amp; Fire</li> <li>• Architectural &amp; Painted Finishes</li> <li>• 1 Year Warranty</li> </ul>

## BENEFITS & FEATURES

### Benefits

- **Tough:** Sturdy construction is ideal for meeting the rigors of demanding industry environments
- **Versatile:** Available in standard painted as well as architectural finishes for both front and back of house applications
- **Economical:** Works for many building projects, regardless of budget
- **Strong & Durable:** ANSI/BHMA Grade 1 Certification ensures long life and reliability

### Features

- High-grade steel components offer superior protection against wear & tear
- Available in a variety of functions and finishes for any application
- Offered in the ASSA ABLOY ACCENTRA® innovative SquareBolt® latchbolt
- ANSI/BHMA Grade 1 certified 
- UL/cUL listed for panic and fire rated doors
- Windstorm certified devices available
- Three year warranty

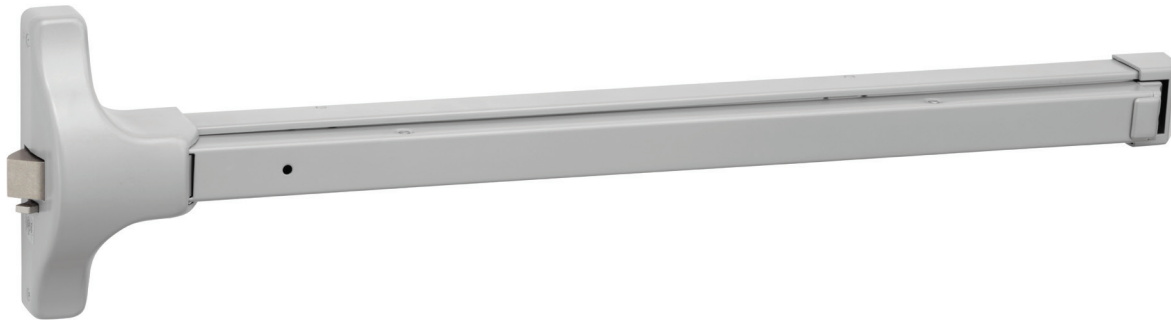

**FINISHES**

ANSI/BHMA Code Finish Description			
<b>613E</b> Dark Oxidized Satin Bronze - equivalent	<b>630*</b> Satin Stainless Steel	<b>689</b> Aluminum Painted	<b>691</b> Light Bronze Painted
			
<b>693</b> Black Painted	<b>695</b> Dark Bronze Painted	<b>BSP</b> Black Suede Powder Coat	<b>WSP</b> White Suede Powder Coat (trim only)
			

\*Finish available with MicroShield® antimicrobial coating, additional finishes by special application. Consult factory for availability.

MicroShield coating may vary finish color from architectural standards. MicroShield is not intended as a substitute for traditional infection control programs such as hand hygiene or use of disinfectants. Coated products must still be cleaned to ensure the surfaces will be free of destructive microbes. ASSA ABLOY ACCENTRA® makes no representations or warranties, express or implied, as to the efficacy of MicroShield.

## HOW TO ORDER

2	1	X	0	Suffix	-XX	Size	Outside Trim	Finish	Other Info
		<b>Third Digit:</b> <b>"0"</b> - Rim Device, Pullman Latch  <b>"1"</b> - SVR Device  <b>"2"</b> - CVR Device  <b>"5"</b> - SquareBolt® Rim Security  <b>"6"</b> - CVR Device  <b>"7"</b> - SVR Device	<b>Fourth Digit:</b>  <b>"0"</b> - Standard	<b>No Suffix</b> - Panic label  <b>"F"</b> - Fire exit device  <b>"WS"</b> - Windstorm Certified Products (see notes 4, 5, 6)	<b>Size: (DOW=Door Opening Width)</b>  <b>"36"</b> - 30" - 36" (0.76m to 0.91m) DOW  <b>"42"</b> - 36" to 42" (0.91m to 1.07m) DOW  <b>"48"</b> - 42" to 48" (1.07m to 1.22m) DOW	<b>Size: (DOW=Door Opening Width)</b>  <b>"36"</b> 30" to 36" DOW  <b>42"</b> 36" to 42" DOW  <b>"48"</b> 36" to 48" DOW  <b>Door Height:</b> <b>-7</b> = 7' standard  <b>-8</b> = 8' (2.44m)  <b>-9</b> = 9' (2.74m)  <b>-10</b> = 10' (3.05m)	<b>Trim Model Number</b>  <b>See pages 13-21</b>	613E 630 689 691 693 695 BSP	<b>Door Hand</b> - RHR or LHR (vertical rod devices or lever escutcheon trim only). Rim devices are field reversible.  <b>SN-134, 1/4-20 Sex Nuts (pack of 4).</b>  <b>SN-104, 10-24 Sex Nuts (pack of 4).</b>  <b>Door thickness:</b> specify if not standard - 1 3/4" (45mm)  <b>Shim Kits:</b> (quantity) 223 (quantity) 224  <b>Optional Strike</b> - See page 30  <b>Bottom Pullman Latch</b> - BPL

Notes:

1. It is recommended that exit devices and trim for the same opening be ordered together. Device and trim are shipped in separate boxes.
2. Standard product is for 1-3/4" (44mm) reinforced metal doors.
3. Accessories detached from the device and trim should be specified separately.
4. "WS" applies only to 2100(F) devices.
5. Maximum opening size 3'0" x 7'0".
6. Contact Ceco, Curries® or Fleming for detailed frame/door requirements and limitations.

## Ordering Examples

### Exit Device Only

2150F-36x630xRHRxSN-134

### Exit Device with Trim and Cylinder

2170F90-48 x -10 x AU626F x 613E x LHR x 1109 GA 0 bit

### Trim Only

AU626F x 626 x RHR.

## 2100(F) RIM

The 2100(F) is a rim exit device to be used with single doors or pairs of doors constructed of metal, wood or composite materials. The 2100(F) can be paired with a wide variety of trims to meet many applications.



### Certification/Compliance

UL/cUL Listed: FVSR/FVSR7 - Panic hardware  
GXHX/GXHX7 - Fire exit hardware (F)  
(4' x 8' single, 8' x 8' pairs, 3 hr.)  
ZHEM - Latching hardware

### Features

- Designed for wide stile doors
- Non-handed for easy installation
- Steel interlock "E" bracket maintains door-to-mullion relationship in fire-labeled devices
- Deadlocking pullman latchbolt positively engages roller strike
- Available certified hurricane resistant (refer to local codes). Specify 2100(F)WS.



Hurricane

### Applications

- Single swing doors
- Pairs of doors (mullion required)
- Metal, wood or composite door materials

### Specifications

<b>Door Opening Width</b>	-36 for 30" - 36" (76cm - 91cm) doors -42 for 36" - 42" (91cm - 107cm) doors -48 for 42" - 48" (107cm - 122cm) doors
<b>Door Thickness</b>	1-3/4" (44mm) standard. Optional door thicknesses available to 3-1/2"; specify door thickness when ordering.
<b>Minimum Stile Width</b>	4-1/2" (114mm)
<b>Projection</b>	2-1/2" (64mm) active, 1-3/4" (44mm) depressed
<b>Latchbolt</b>	3/4" (19mm) deadlocking stainless steel pullman-type
<b>Strike</b>	757F, 793 optional (double door application, panic only)
<b>Fasteners</b>	Machine screws and wood door fasteners standard for panic hardware. Sex nuts and bolts supplied standard for fire exit hardware.
<b>Trims</b>	121NL cylinder only, 210F series utility trim, 440F series rose trim, 580F series rose trim with escutcheon plate, 620F series escutcheon trim, 630F series pull/thumbpiece trim. See pages 13-21.
<b>ANSI/BHMA</b>	Certified: A156.3 Type 1, Grade 1
<b>Dogging</b>	Hex key dogging supplied standard on panic devices
<b>Finishes</b>	613E, 630, 689, 691, 693, 695, BSP
<b>Options</b>	Shim kit #223, sex nuts and bolts, MicroShield®
<b>Warranty</b>	3-year limited

## 2150(F) SQUAREBOLT®

Just as easy to open as traditional latchbolts, the SquareBolt® exit device's unique construction offers innovative protection. The SquareBolt's design presents an improved physical barrier over standard rim latchbolts. The SquareBolt exit device locks into place and stays there. Credit cards, crowbars, door rattling and shaking are resisted, significantly reducing the threat of unauthorized entry.



### Certification/Compliance

UL/cUL Listed: FVSR/FVSR7 - Panic hardware  
GXHX/GXHX7 - Fire exit hardware (F)  
(4' x 8' single, 8' x 8' pairs, 3 hr.)

### Features

- SquareBolt security deadbolt designed for maximum holding power
- Designed for wide stile doors
- Non-handed for easy installation
- Steel interlock "E" bracket maintains door-to-mullion relationship in fire-labeled devices

### Applications

- Single swing doors
- Pairs of doors (mullion required)
- Metal, wood or composite door materials

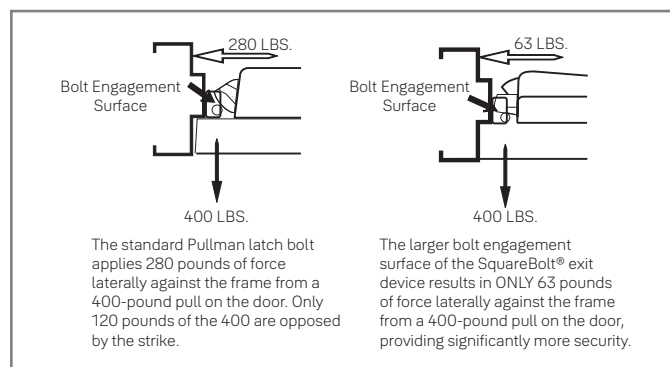

### Specifications

<b>Door Opening Width</b>	-36 for 30" - 36" (76cm - 91cm) doors -42 for 36" - 42" (91cm - 107cm) doors -48 for 42" - 48" (107cm - 122cm) doors
<b>Door Thickness</b>	1-3/4" (44mm) standard. Optional door thicknesses available to 3-1/2"; specify door thickness when ordering.
<b>Minimum Stile Width</b>	4-1/2" (114mm)
<b>Projection</b>	2-1/2" (64mm) active, 1-3/4" (44mm) depressed
<b>Deadbolt</b>	1" (25mm) slide projection bolt with full 3/4" (19mm) projection
<b>Strike</b>	757F, 793 optional (double door application, panic only)
<b>Fasteners</b>	Machine screws and wood door fasteners standard for panic hardware. Sex nuts and bolts supplied standard for fire exit hardware.
<b>Trims</b>	121NL cylinder only, 210F series utility trim, 440F series rose trim, 580F series rose trim with escutcheon plate, 620F series escutcheon trim, 630F series pull/thumbpiece trim. See pages 13-21.
<b>ANSI/BHMA</b>	Certified: A156.3 Type 1 or 28, Grade 1
<b>Dogging</b>	Hex key dogging supplied standard on panic devices
<b>Finishes</b>	613E, 630, 689, 691, 693, 695, BSP
<b>Options</b>	Shim kit #223, sex nuts and bolts, MicroShield®
<b>Warranty</b>	3-year limited

## 2110(F) SURFACE VERTICAL ROD

The 2110(F) is a surface vertical rod exit device to be used on metal, wood or composite pairs of doors up to 8' (fire) and 10' (panic) where two-point latching is desired.

### Certification/Compliance

UL/cUL Listed: FVSR/FVSR7 - Panic hardware  
GXHX/GXHX7 - Fire exit hardware (F)  
(8' x 8' pairs, 3 hr.)

### Features

- Designed for wide stile doors
- Handed, specify hand (field reversible)
- Positive action linkage on a deadlocking top pullman bolt
- Simultaneous direct pull bottom deadbolt
- When unlatched, device keeps both bolts retracted until door is shut

### Applications

- Pairs of doors
- Double egress
- Metal, wood or composite door materials



### Specifications

<b>Door Opening Width</b>	-36 for 30" - 36" (76cm - 91cm) doors -42 for 36" - 42" (91cm - 107cm) doors -48 for 42" - 48" (107cm - 122cm) doors
<b>Door Opening Height</b>	Standard door height 7' (213cm), with the device centerline at 39-15/16" (101cm) from floor. Optional heights up to 8' (fire) and 10' (panic) available by using rod extensions. For fire rated openings over 8', see 2170F SVR.
<b>Door Thickness</b>	1-3/4" (44mm) standard. Optional door thicknesses available to 3-1/2"; specify door thickness when ordering.
<b>Minimum Stile Width</b>	4-1/2" (114mm)
<b>Projection</b>	2-1/2" (64mm) active, 1-3/4" (44mm) depressed
<b>Latchbolt</b>	Top: 3/4" (19mm) throw, pullman-type with automatic deadlatching. Bottom: 5/8" (16mm) throw deadbolt, held retracted during door swing.
<b>Vertical Rods</b>	1/2" (13mm) O.D. tubular brass, bronze or stainless steel with rod guides
<b>Strike</b>	Top: Roller type 791. Bottom: Flush mounted 790. 794 floor strike optional (threshold openings).
<b>Fasteners</b>	Machine screws and wood door fasteners standard for panic hardware. Sex nuts and bolts supplied standard for fire exit hardware.
<b>Trims</b>	210F series utility trim, 440F series rose trim, 580F series rose trim with escutcheon plate, 620F series escutcheon trim, 630F series pull/thumbpiece trim. See pages 13-21.
<b>ANSI/BHMA</b>	Certified A156.3 Type 2, Grade 1
<b>Dogging</b>	Hex key dogging supplied standard on panic devices
<b>Finishes</b>	613E, 630, 689, 691, 693, 695, BSP
<b>Options</b>	Shim kit #224, sex nuts and bolts, bottom pullman latch (panic only), MicroShield®
<b>Warranty</b>	3-year limited

## 2170(F) SURFACE VERTICAL ROD

The 2170(F) is a surface vertical rod exit device to be used on wide stile and flush doors up to 10' where one or two-point latching is desired. A Less Bottom Rod (LBR) option is available.

### Certification/Compliance

UL/cUL Listed: FVSR/FVSR7 - Panic hardware  
GXHX/GXHX7 – Fire exit hardware (F) (8' x 10' pairs, 1-1/2 hr.) (8' x 8' pairs, 3 hr.)

### Features

- Designed for wide stile and flush doors
- Mechanisms made of heavily electroplated high-grade steel and non-ferrous materials provide sturdy construction and superior protection against corrosion
- Interlocking top strike and latch mounting plate for added stability
- Handed, specify hand (field reversible)
- Available less bottom rod (LBR option)

### Applications

- Pairs of doors
- Double egress
- Metal, wood, or composite door materials

### Specifications

<b>Door Opening Width</b>	-36 for 30" - 36" (76cm - 91cm) doors -42 for 36" - 42" (91cm - 107cm) doors -48 for 42" - 48" (107cm - 122cm) doors
<b>Door Opening Height</b>	Standard door height 7' (213cm), with the device centerline at 39-15/16" (101cm) from floor. Optional heights specify suffix -8, -9, -10.
<b>Door Thickness</b>	1-3/4" (44mm) standard. Optional door thicknesses available to 3-1/2"; specify door thickness when ordering.
<b>Minimum Stile Width</b>	4-1/2" (114mm)
<b>Projection</b>	2-1/2" (64mm) active, 1-3/4" (44mm) depressed
<b>Latchbolt</b>	Top: 3/4" (19mm) throw, pullman-type with automatic deadlatching. Bottom: 5/8" (16mm) throw deadbolt, held retracted during door swing.
<b>Vertical Rods</b>	1/2" (13mm) O.D. tubular brass, bronze or stainless steel with rod guides
<b>Strike</b>	Top: 726. Bottom: Flush-mounted 790. 794 floor strike optional (threshold openings).
<b>Fasteners</b>	Machine screws and wood door fasteners standard for panic hardware. Sex nuts and bolts supplied standard for fire exit hardware.
<b>Trims</b>	210F series utility trim, 440F series rose trim, 580F series rose trim with escutcheon plate, 620F series escutcheon trim, 630F series pull/thumbpiece trim. See pages 13-21.
<b>ANSI/BHMA</b>	Certified A156.3 Type 2, Grade 1
<b>Dogging</b>	Hex key dogging supplied standard on panic devices
<b>Finishes</b>	613E, 630, 689, 691, 693, 695, BSP
<b>Options</b>	Shim kit #223, sex nuts and bolts, bottom pullman latch (panic only), less bottom rod (LBR), -8, -9, -10 opening height, rod extensions, MicroShield®
<b>Warranty</b>	3-year limited

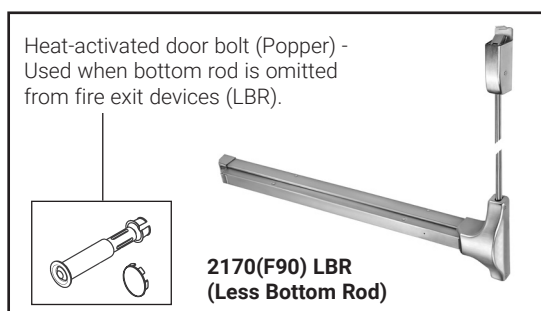
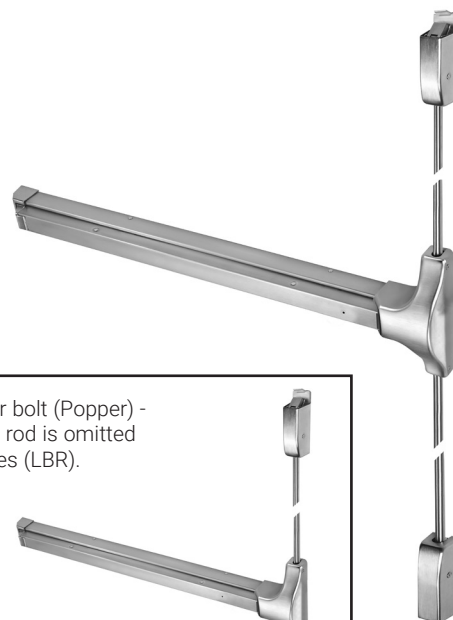

## 2120(F) CONCEALED VERTICAL ROD

The 2120(F) is a concealed vertical rod exit device to be used on metal doors only up to 8' (fire) and 10' (panic) where two-point latching is desired.

### Certification/Compliance

UL/cUL Listed: FVSR/FVSR7 - Panic hardware  
GXHX/GXHX7 - Fire exit hardware (F)  
(8' x 8' pairs, 3 hr.)

### Features

- Designed for wide stile doors
- Handed, specify hand (field reversible)
- Positive action linkage on a deadlocking top pullman bolt
- Simultaneous direct pull bottom deadbolt
- When unlatched, device keeps both bolts retracted until door is shut

### Applications

- Pairs of doors
- Double egress
- Metal doors only

### Specifications

<b>Door Opening Width</b>	-36 for 30" - 36" (76cm - 91cm) doors -42 for 36" - 42" (91cm - 107cm) doors -48 for 42" - 48" (107cm - 122cm) doors
<b>Door Opening Height</b>	Standard door height adjustable to 8' (244cm), with the device centerline at 39-15/16" (101cm) from floor. Optional heights up to 10' (panic) available by using rod extensions. For fire rated openings over 8', see 2160F CVR.
<b>Door Thickness</b>	1-3/4" (44mm) standard. 2" and 2-1/4" (51mm and 57mm) optional; specify when ordering.
<b>Minimum Stile Width</b>	4-1/2" (114mm)
<b>Projection</b>	2-1/2" (64mm) active, 1-3/4" (44mm) depressed
<b>Latchbolt</b>	Top: 3/4" (19mm) throw, pullman-type with automatic deadlatching Bottom: 5/8" (16mm) throw deadbolt, held retracted during door swing
<b>Vertical Rods</b>	1/2" (13mm) O.D. telescoping tubular rods
<b>Strike</b>	Top: Roller type 791. Bottom: Flush mounted 790. 794 floor strike optional (threshold openings).
<b>Fasteners</b>	Machine screws standard for panic hardware. Sex nuts and bolts supplied standard for fire exit hardware.
<b>Trims</b>	210F series utility trim, 440F series rose trim, 580F series rose trim with escutcheon plate, 620F series escutcheon trim, 630F series pull/thumbpiece trim. See pages 13-21.
<b>ANSI/BHMA</b>	Certified A156.3 Grade 1, Type 8, Grade 1
<b>Dogging</b>	Hex key dogging supplied standard on panic devices
<b>Finishes</b>	613E, 630, 689, 691, 693, 695, BSP
<b>Options</b>	Shim kit #223, sex nuts and bolts, bottom pullman latch (panic only), MicroShield®
<b>Warranty</b>	3-year limited



## 2160(F) CONCEALED VERTICAL ROD

The 2160(F) is a concealed vertical rod exit device to be used on wood and metal doors up to 10' where one or two-point latching is desired. A Less Bottom Rod (LBR) option is available.

### Certification/Compliance

UL/cUL Listed: FVSR/FVSR7 - Panic hardware  
GXHX/GXHX7 – Fire exit hardware (F)  
(8' x 10' pairs, 1-1/2 hr.) (8' x 8' pairs, 3 hr.)

### Features

- Designed for wide stile and flush doors
- Mechanisms made of heavily electroplated high-grade steel and non-ferrous materials provide sturdy construction and superior protection against corrosion
- Handed, specify hand (field reversible)
- Available less bottom rod (LBR option)

### Applications

- Pairs of doors
- Double egress
- Metal, wood, or composite door materials

### Specifications

<b>Door Opening Width</b>	-36 for 30" - 36" (76cm - 91cm) doors -42 for 36" - 42" (91cm - 107cm) doors -48 for 42" - 48" (107cm - 122cm) doors
<b>Door Opening Height</b>	Standard door height adjustable to 8' (244cm), with the device centerline at 39-15/16" (101cm) from floor. Optional heights specify suffix -9, -10.
<b>Door Thickness</b>	1-3/4" (44mm) standard. 2" and 2-1/4" (51mm and 57mm) optional; specify when ordering.
<b>Minimum Stile Width</b>	4-1/2" (114mm)
<b>Projection</b>	2-1/2" (64mm) active, 1-3/4" (44mm) depressed
<b>Latchbolt</b>	Top: 3/4" (19mm) throw, pullman-type with automatic deadlatching Bottom: 5/8" (16mm) throw deadbolt, held retracted during door swing
<b>Vertical Rods</b>	1/2" (13mm) O.D. telescoping tubular rods
<b>Strike</b>	Top: Mortised 761. Bottom: Flush-mounted 790. 794 floor strike optional (threshold openings).
<b>Fasteners</b>	Machine screws and wood door fasteners standard for panic hardware. Sex nuts and bolts supplied standard for fire exit hardware.
<b>Trims</b>	210F series utility trim, 440F series rose trim, 580F series rose trim with escutcheon plate, 620F series escutcheon trim, 630F series pull/thumbpiece trim. See pages13-21.
<b>ANSI/BHMA</b>	Certified A156.3 Type 7 and 8, Grade 1
<b>Dogging</b>	Hex key dogging supplied standard on panic devices
<b>Finishes</b>	613E, 630, 689, 691, 693, 695, BSP
<b>Options</b>	Shim kit #223, sex nuts and bolts, bottom pullman latch (panic only), less bottom rod (LBR), -9, -10 opening height, rod extensions, MicroShield®
<b>Warranty</b>	3-year limited

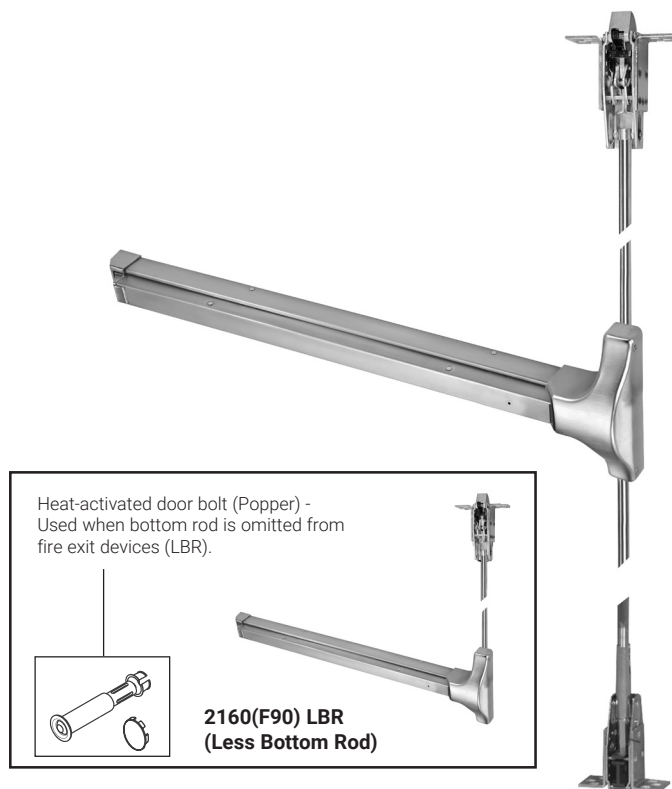

## TRIM DESIGNS

### Escutcheons

420F Series	480F Series	580F Series	620F Series	630F/660F/670F Series
				
Projection: see levers	Projection: 2-13/32" (61mm)	Projection: see levers	Projection: see levers	Projection: 2-1/8" (54mm)

### Roses

440F Series	540F Series
	
Projection: 3-1/2" (89mm)	Projection: 3-1/2" (89mm)

### Standard Escutcheon Trim





























Arcadia AR 	Augusta AU 	Carmel CR 
		
Projection: 3-1/4" (82mm)	Projection: 2-5/8" (61mm)	Projection: 3-1/8" (79mm)
Jefferson JN 	Monroe MO 	Pacific Beach PB 
		
Projection: 2-9/16" (65mm)	Projection: 3" (76mm)	Projection: 3-5/16" (84mm)
Pinehurst PN 	Virginia VI 	Hampton HA 
		
Projection: 3-1/16" (78mm)	Projection: 3-1/8" (79mm)	Projection: 3-3/8" (86mm)

Note: Projection dimensions are provided using the 620F series escutcheon plates.

**TRIM DESIGNS**

**Reflections® Levers**



<b>Hudson</b>	TB	UB	TC	TD	UC		
							
Projection	3-1/16" (78mm)	3-1/4" (83mm)	3" (76mm)	3-7/16" (87mm)	3-7/16" (87mm)		
<b>Spree</b>	RS	RT	RU	RV			
							
Projection	3-1/8" (79mm)	3-1/8" (79mm)	3-13/32" (87mm)	3" (76mm)			
<b>Seine</b>	TE	TG	TI	TJ	TK	GT	
							
Projection	3" (76mm)	2-13/16" (61mm)	3-3/8" (85mm)	3-1/16" (78mm)	3-1/4" (83mm)	3-1/4" (83mm)	
<b>Thames</b>	TM	TN	TP	TR	TS	TQ	
							
Projection	3-1/16" (78mm)	3-1/16" (78mm)	3-5/16" (84mm)	3-1/16" (78mm)	3-1/8" (80mm)	3-1/16" (78mm)	
<b>Victoria</b>	TT	TU	TW	TX	UX	TY	WG
							
Projection	2-11/16" (68mm)	3-1/4" (83mm)	3" (76mm)	3-5/8" (92mm)	3-7/16" (87mm)	3-5/16" (84mm)	3-5/8" (92mm)
<b>Niagara</b>	MA	RA	RB	RC			
							
Projection	2-13/16" (71mm)	3-11/16" (94mm)	2-13/16" (71mm)	2-13/16" (71mm)			

**Notes:**

Projection dimensions are provided using the 620F Series escutcheon plates.

The following Reflections levers are not available in 629 or 630 finish: Victoria TT, TU, TW, TX, TY, UX; Seine TG, TJ, TK, TE, TI; Hudson TD. Please consider the 618 or 619 finish as an alternative. Reflections levers are not available with knurling option.

## 2100 SERIES TRIMS

### 420F Series Escutcheon Trim



- Certified ANSI/BHMA A156.3, Grade 1
- Trim through-bolts to exit device for strength
- Strong cast zinc escutcheon
- Thru-bolt. 1-3/4" (44mm) door standard. For doors thru 2-1/4" (57mm) or shim-mounted devices, specify on order.
- Dimensions: 2-1/2" x 9-1/2" x 7/16" (64mm x 241mm x 11mm)
- Available only with AU/MO/PB levers
- Cylinders not included. For rim cylinders, see page 26.
- Finishes: 626, 689, 691, 693 and 695
- 1-year warranty
- **Ordering Example: PB428F x LHR x 689**

Applications	Cylinder	Exit Only Blank Plate	Nightlatch	Classroom/ Storeroom	Nightlatch	Dummy Free Wheeling	Passage	Dummy Rigid Lever
2100(F) 2150(F)	Rim	420F	421F*	426F	427F*	428F	428F	429F
ANSI		01	03	08/09	03	02	14	02

\*Not recommended for use with 2110, 2170, 2120 & 2160 exit devices.

Note: 09 and Free Wheeling 02 achieved with single trim modification at installation.

## 2100 SERIES TRIMS

### 620F Series Wide Escutcheon Trim



- Certified ANSI/BHMA A156.3, Grade 1.
- Trim through-bolts to exit device for strength.
- Beveled sides improve attack resistance.
- Solid forged/cast escutcheon and free-wheeling trim for ideal protection.
- Flush cylinder in 6-pin applications for additional security.
- 1-3/4" (44mm) door standard. For doors through 2-1/4" (57mm) or shim-mounted devices, specify on order.
- Dimensions: 3" x 10-1/4" x 13/16" (76mm x 260mm x 19mm).
- Cylinders not included. See page 26 for cylinder options.
- Available with AR, AU, CR, JN, MO, PB, PN, VI, HA lever designs. See page 13.
  - Finishes: 613E, 626, 630, 693, BSP, WSP
- Available with Reflections® lever designs. See page 14.
  - Finishes: 613E, 626, 630, BSP, WSP
- **Trim ordering example: AU626F x 626 x RHR.**
- 5-year limited warranty.

Application	Cylinder	Classroom/ Storeroom Cylinder Controls Thumbturn	Exit Only Blank Plate	Nightlatch Access by Key	Classroom Cylinder Controls Lever	Storeroom Cylinder Controls Lever	Nightlatch Cylinder by Lever	Passage	Dummy Trim Free- Wheeling	Dummy Rigid Lever
2100(F) 2150(F) 2110(F) 2120(F) 2160(F) 2170(F)	Rim	603F <sup>1</sup>	620F	621F <sup>2</sup>	626F	626F <sup>1</sup>	627F <sup>2</sup>	628F	628F <sup>1</sup>	629F
ANSI		11/12	01	03	08	09	03	14	02	02

<sup>1</sup> 09, 12 and Free Wheeling 02 achieved with single trim modification at installation.

<sup>2</sup> Not recommended for use with vertical rod exit devices.

For 626 & 630 finishes the escutcheon and standard levers are plated to simulate stainless steel. Optional door thickness available up to 3-1/2", specify on order.

## 2100 SERIES TRIMS

### 630F Series Wide Pull/Thumbpiece Trim



- Certified ANSI/BHMA A156.3, Grade 1.
- Trim through-bolts to exit device for strength.
- Beveled sides improve attack resistance.
- Flush cylinder in 6-pin applications for additional security.
- 1-3/4" (44mm) door standard. For doors through 2-1/4" (57mm) or shim-mounted devices, specify on order.
- Plate Dimensions: 2-3/4" x 15-1/2" x 5/8" (70mm x 394mm x 16mm).
- Pull Dimensions: 6-7/16" (164mm) on centers x 2-1/8" (54mm) projection.
- Cylinders not included. See page 26 for cylinder options.
- Finishes: 613E, 626, 630, 693, BSP, WSP
- **Trim ordering example: 630F x 630 x RHR**
- 5-year limited warranty.

Applications	Cylinder	Exit Only Blank Plate	Nightlatch Access by Key	Nightlatch Cylinder by Pull	Classroom Cylinder Controls T-Piece	Storeroom Cylinder Controls T-Piece	Dummy Trim Pull Plate	Passage Active T-Piece
2100(F) 2150(F) 2110(F) 2120(F) 2160(F) 2170(F)	Rim	630F	631F <sup>2</sup>	632F <sup>2</sup>	633F	633F <sup>1</sup>	634F	635F
ANSI		01	03	03	05	06	02	15

<sup>1</sup> 06 achieved with single trim modification at installation.

<sup>2</sup> Not recommended for use with vertical rod exit devices.

For 626 & 630 finishes the escutcheon is plated to simulate stainless steel.

Optional door thickness available up to 3-1/2", specify on order.

## 2100 SERIES TRIMS

### 440F Series Rose Trim



- Certified ANSI/BHMA A156.3, Grade 1.
- 440F rose trim for stock doors.
- 1-3/4" (44mm) door standard. For doors through 2-1/4" (57mm) or shim-mounted devices, specify on order.
- AU, PB and MO trim designs. See below.
- Cylinders included, accepts 6-pin cylindrical type cylinders. If 7-pin cylinders are required, reference 540F trim. See page 27 for cylinder options.
- Finishes: 613E, 626, 689, 691, 693, 695, BSP, WSP
- "B" trim prefix - Lever trim accepting all small format interchangeable cores. 6- or 7-pin. **(Example: B-AU446F)**
- "M" trim prefix - Lever trim accepting Medeco® (32 series) and ASSA® large format interchangeable cores. Available in AU lever only. 6-pin only. **(Example: M-AU446F)**
- "S" trim prefix - Lever trim accepting Schlage® standard cylinders. 6-pin only. **(Example: S-AU446F)**
- "SI" trim prefix - Lever trim accepting Schlage® large format interchangeable cores. Available in AU and PB levers only. 6-pin only. **(Example: SI-AU446F)**
- Please specify when ordering 1210 LFIC prep.
- 2-year limited warranty.

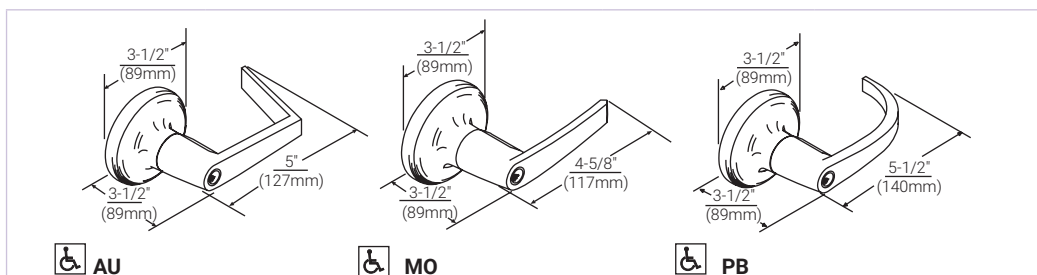

Applications	Nightlatch Access by Key	Classroom Cylinder Controls Lever	Dummy Trim Free Wheeling Lever	Passage Lever	Dummy Trim Rigid Lever
2100(F), 2150(F), 2110(F), 2120(F), 2160(F), 2170(F)	441F*	446F	448F	448F	449F
ANSI	03	08	02	14	02

\*Not recommended for use with vertical rod exit devices.

## 2100 SERIES TRIMS

### 540F Series Rose Trim



- Certified ANSI/BHMA A156.3, Grade 1.
- 540F rose trim for stock doors.
- Trim through-bolts to exit device for strength.
- 1-3/4" (44mm) door standard. For doors through 2-1/4" (57mm) or shim-mounted devices, specify on order.
- AU, PB and MO trim designs.
- Accepts cylindrical type cylinders. Cylinders included, see page 27 for cylinder options.
- Please specify when ordering 1210 LFIC prep.
- Finishes: 605, 606, 613E, 625, 626, BSP, WSP.
- 3-year limited warranty.

"B" trim prefix	Lever trim accepting all small format interchangeable cores. 6- or 7-pin <b>(Example: B-AU546F)</b>
"M" trim prefix	Lever trim accepting Medeco® (32 Series) and ASSA® large format interchangeable cores. Available in AU lever only. 6-pin only. <b>(Example: M-AU546F)</b>
"S" trim prefix	Lever trim accepting Schlage® standard cylinders. 6-pin only. <b>(Example: S-AU546F)</b>
"SI" trim prefix	Lever trim accepting Schlage® large format interchangeable cores. 6-pin only. <b>(Example: SI-AU546F)</b>

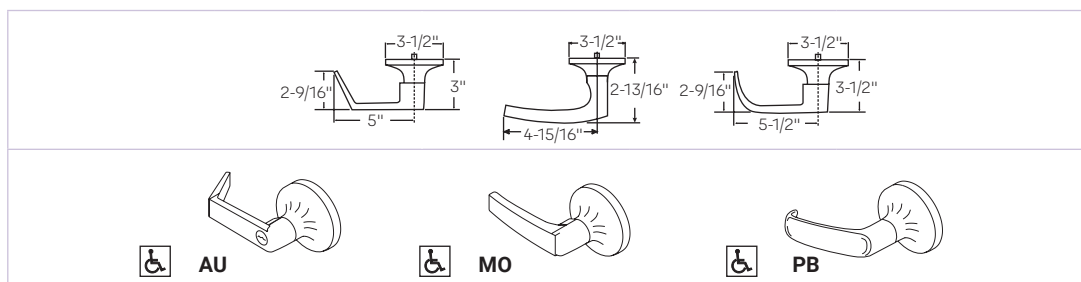

Applications	Nightlatch Access by Key	Classroom Cylinder Controls Lever	Passage Lever	Dummy Trim Free-Wheeling Lever	Dummy Trim Rigid Lever
2100(F), 2150(F), 2110(F) 2120(F), 2160(F), 2170(F)	541F*	546F	548F	548F	549F
ANSI	03	08	14	02	02

\*Not recommended for use with vertical rod exit devices.

## 2100 SERIES TRIMS

### 580F Series Rose Trim With Escutcheon Plate



- 580F rose trim with escutcheon plate for stock doors.
- 1-3/4" (44mm) door standard. For doors thru 2-1/4" (57mm) or shim-mounted devices, specify on order.
- AU, PB and MO trim designs. See below.
- Plate Dimensions: 4" (102mm) x 8" (204mm) x 1/8" (3mm)
- Cylinders included, accepts cylindrical type cylinders. See page 27.
- Finishes - 613E, 626, 689, BSP, WSP.
- "B" trim prefix - Lever trim accepting all small format interchangeable cores. 6- or 7-pin **(Example: B-AU586F)**
- "M" trim prefix - Lever trim accepting Medeco® (32 series) and ASSA® large format interchangeable cores. Available in AU lever only. 6-pin only. **(Example: M-AU586F)**
- "S" trim prefix - Lever trim accepting Schlage® standard cylinders. 6-pin only. **(Example: S-AU586F)**
- "SI" trim prefix - Lever trim accepting Schlage® large format interchangeable cores. 6-pin only. **(Example: SI-AU586F)**
- 3-year limited warranty.

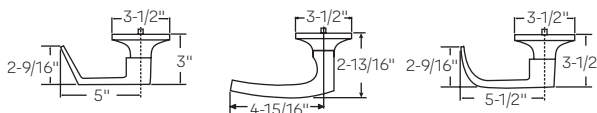

Applications	Nightlatch Access by Key	Classroom Cylinder Controls Lever	Dummy Trim Free Wheeling Lever	Passage Lever	Dummy Trim Rigid Lever
2100(F), 2150(F), 2110(F), 2120(F), 2160(F), 2170(F)	581F*	586F	588F	588F	589F
ANSI	03	08	02	14	02

\*Not recommended for use with vertical rod exit devices.

## 2100 SERIES TRIMS

### 210F Series Trim

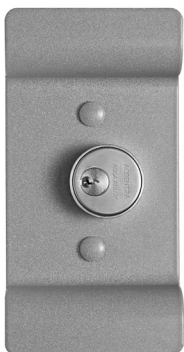

- 1-3/4" (44mm) door standard. For doors through 2-1/4" (54mm) or shim-mounted devices, specify on order.
- Cylinders not included. For rim cylinder options, see page 26.
- Plate Dimensions: 3-1/2" x 3-3/4" x 3/32" (89mm x 95mm x 3mm)
- Finger Pull Dimensions: 3-1/2" x 6-3/4" x 1/8" (89mm x 171mm x 3mm)
- Finishes: 689, 691, 695
- 1-year limited warranty

Applications	Cylinder	Nightlatch Access by Key	Dummy Trim Pull Plate	Nightlatch Cylinder by Pull
2100(F), 2150(F)	Rim	213F	214F	217F
ANSI		03	02	03

Not recommended for surface or concealed vertical rod devices.



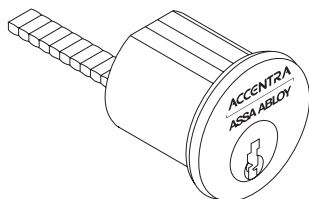









































### 121NL Cylinder Only



Function Description	Nightlatch Access by Key
Model No.	121NL
ANSI	03

- Application: 2100(F) and 2150(F) rim and SquareBolt® exit devices. Not recommended for surface or concealed vertical rod devices.
- Must specify rim cylinder when ordering. See page 26 for cylinder options.
- Cylinder collar 1765.250 furnished standard for 1-3/4" thick doors.
- For 1109, 5109, K300, K640, A640 and 2109 cylinders:
  - Screw part number 34-2311-8738-048
  - Backplate part number 34-0010-1015-059
- For 1193, 5193 and K840 cylinders:
  - Screw part number 10-1193-1018-048
  - Backplate part number 34-0010-1015-059





**FUNCTIONS**

SquareBolt® (Type 1 or 28) 2150(F)	Rim (Type 1) 2100(F)	Surface Vertical Rod (Type 2) 2110(F) 2170(F90)	Concealed Vertical Rod (Type 7 & 8) 2120(F) 2160(F90)	Function Description	ANSI Function No.	Trim Model Number
				Exit Only, No Trim/Exit Only, Blank Plate	01	620F 630F
		 <sup>3</sup>	 <sup>3</sup>	Pull to Open (Dummy Trim)	02	214F 589F <sup>1,2</sup> 448F <sup>1,2</sup> 624F 629F <sup>2</sup> 449F <sup>1,2</sup> 625F 634F <sup>2</sup> 588F <sup>1,2</sup> 628F <sup>1,2</sup>
				Key Retracts Latchbolts (NL)	03	121NL 581F <sup>2</sup> 213F 621F 631F 217F 623F 632F <sup>2</sup> 441F <sup>2</sup> 627F <sup>2</sup>
				Entrance by Thumbpiece (Key Locks/ Unlocks Thumbpiece)	05	633F
				Key Unlocks Thumbpiece (Key Removable When Locked)	06	633F <sup>1</sup>
				Entrance by Lever (Key Locks/ Unlocks Lever)	08	446F <sup>2</sup> 586F <sup>2</sup> 626F <sup>2</sup>
				Key Unlocks Lever (Key Removable When Locked)	09	626F <sup>1,2</sup>
				Cylinder Controls Thumbturn	11	603F
				Key & Thumbturn (Key Removable When Locked)	12	
				Lever Always Active (Passage)	14	448F <sup>2</sup> 588F <sup>2</sup> 628F <sup>2</sup>
				Thumbpiece Always Active (Passage)	15	635F

Sectional dummy trim (02) features levers that will turn, but will not operate the devices. For rigid lever use AU629F, or AU449F. Illustrations show typical function features, rather than pictorial renderings of the trims listed. Specific trim details are shown on pages 13-21.

<sup>1</sup> Trims require an easy field change to adapt them for the charted function. <sup>2</sup> ADA compliant trim. <sup>3</sup> Application not recommended

## APPLICATIONS

Single Door	UL Listing	Maximum Opening	Application	
<b>SquareBolt®</b>				
2150	Panic	4' x *	Surface applied; single-point latching.	
2150F	3 Hr.	4' x 8'		
<b>Rim</b>				
2100	Panic	4' x *	Surface applied; single-point latching.	
2100F	3 Hr.	4' x 8'		
2100WS	Panic	3' x 7'	Surface applied; single-point latching. Used as components in swinging door windstorm-rated assemblies (refer to local codes).	
2100FWS	3 Hr.	3' x 7'		
<b>Surface Vertical Rod</b>				
2110	Panic	4' x 10'	Surface applied; two-point latching.	
2170	Panic	4' x 10'		
2170 x LBR	Panic	4' x 10'	Surface applied; one-point latching.	
<b>Concealed Vertical Rod</b>				
2120	Panic	4' x 10'	Rods concealed in door; two-point latching	
2160	Panic	4' x 10'		
2160 x LBR	Panic	4' x 10'	Rods concealed in door; one-point latching	

\*UL does not set a door height limitation on panic applications.

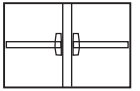
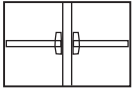
Pair of Doors with Removable Mullion	UL Listing	Maximum Opening	Application	
<b>SquareBolt® x SquareBolt®</b>				
2150 x 2150 x M200	Panic	8' x 10'	Two independent active doors with removable mullion.	
2150F x 2150F x M200F	3 Hr.	8' x 8'		
<b>Rim x Rim</b>				
2100 x 2100 x M200	Panic	8' x 10'	Two independent active doors with removable mullion.	
2100F x 2100F x M200F	3 Hr.	8' x 8'		

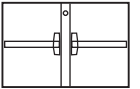
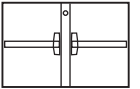
Pair of Doors with Keyed Removable Mullion	UL Listing	Maximum Opening	Application	
<b>SquareBolt® x SquareBolt®</b>				
2150 x 2150 x KRM200	Panic	8' x 10'	Two independent active doors with removable mullion.	
2150F x 2150F x KRM200F	3 Hr.	8' x 8'		
<b>Rim x Rim</b>				
2100 x 2100 x KRM200	Panic	8' x 10'	Two independent active doors with removable mullion.	
2100F x 2100F x KRM200F	3 Hr.	8' x 8'		

## APPLICATIONS

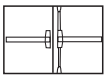
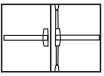
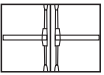
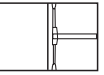
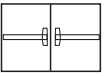
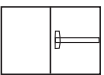
Pair of Doors	UL Listing	Maximum Opening	Application	
<b>SquareBolt® x Surface Vertical Rod</b>				
2150 x 2110	Panic	8' x 10'	Two independent doors with two-point latching, swinging in the same direction.	
2150 x 2170	Panic	8' x 10'	Two independent doors with one- or two-point latching, swinging in the same direction.	
<b>Rim x Surface Vertical Rod</b>				
2100 x 2110	Panic	8' x 10'	Two independent doors with two-point latching, swinging in the same direction.	
2100 x 2170	Panic	8' x 10'	Two independent doors with one- or two-point latching, swinging in the same direction.	
<b>Surface Vertical Rod</b>				
2110 x 2110	Panic	8' x 10'	Two independent doors with two-point latching, swinging in the same direction.	
2110F x 2110F	3 Hr.	8' x 8'		
2170 x 2170	Panic	8' x 10'	Two independent doors with one- or two-point latching, swinging in the same direction.	
2170F90 x 2170F90	1-1/2 Hr.	8' x 10'		
2170F x 2170F	3 Hr.	8' x 8'		
<b>Surface Vertical Rod (Double Egress)</b>				
2110 x 2110	Panic	8' x 10'	Two independent doors with two-point latching, swinging in opposite directions. Overlapping astragal required for 3-hour openings.	
2110F x 2110F	3 Hr.	8' x 8'		
2170 x 2170	Panic	8' x 10'	Two independent doors with one- or two-point latching, swinging in opposite directions. Overlapping astragal not required.	
2170F90 x 2170F90	1-1/2 Hr.	8' x 10'		
2170F x 2170F	3 Hr.	8' x 8'		
<b>Concealed Vertical Rod</b>				
2120 x 2120	Panic	8' x 10'	Two independent metal doors with two-point latching, swinging in the same direction.	
2120F x 2120F	3 Hr.	8' x 8'		
2160 x 2160	Panic	8' x 10'	Two independent metal or wood doors with one- or two-point latching, swinging in the same direction.	
2160F90 x 2160F90	1-1/2 Hr.	8' x 10'		
2160F x 2160F	3 Hr.	8' x 8'		
<b>Concealed Vertical Rod (Double Egress)</b>				
2120 x 2120	Panic	8' x 10'	Two independent metal doors with two-point latching, swinging in opposite directions. Overlapping astragal required for 3-hour openings.	
2120F x 2120F	3 Hr.	8' x 8'		
2160 x 2160	Panic	8' x 10'	Two independent metal or wood doors with one- or two-point latching, swinging in opposite directions. Overlapping astragal not required.	
2160F90 x 2160F90	1-1/2 Hr.	8' x 10'		
2160F x 2160F	3 Hr.	8' x 8'		

## ELECTRIFIED OPTIONS

### Standalone Door Alarm

The SDA16 stand-alone battery operated door alarm is designed to continually monitor the status of a door. When the door is opened without authorization, an alarm is triggered to alert the security violation. This alarm features a Peizo horn which blasts a deafening 105+ decibels to alert the violation.

This unit is ideal for emergency doors as well as stairwell doors and rear exit doors in retail environments. The unit, which can also be hardwired, easily complements existing hardware, making any opening alarmed. The SDA16 door alarm is typically mounted on the interior of the door frame or door and is paired with a magnet mounted on the opposing side of the door gap.

### Remote Mounting

The SDA16 can be installed remotely from the door by attaching the contacts to the door and frame. The unit can be installed up to 6 feet from the door. This provides the ideal solution for circumstances where exposure to weather may be an issue. To order specify "SDA16XL".

### Cylinders And Accessories

- 784 Power supply (9VDC) — includes plug-in wall transformer
- Plug-in wall transformer with 12' cable assembly (part no. 00-0000-3425)
- Gel-cell battery — optional for use with 784 power supply (part no. 00-0000-3426)
- WH-11 Wire harness for remote power and remote unlock
- Mortise cylinder for unit
- Rim cylinder for outside control
- See pages 26-28 for cylinder information.

### Features

- Dimensions: 8.3"L x 3.1"W x 2.0"D (210mm L x 79mm W x 52mm D)
- Non-handed unit (field reversible)
- Unit powered by 9V battery
- Unit can be hardwired by using WH-11 wire harness and 784 power supply
- No battery is required in unit with hard-wire option – if power is lost, optional gel-cell battery in power supply will give approximately 10,000 operations
- Reverse battery protection safeguards the unit if the battery is incorrectly installed
- A low-voltage battery is indicated by an audible signal every 30 seconds
- Piezo horn blasts at 105+ decibels if the door is used with out proper authorization
- The LED will flash every 30 seconds, indicating either the unit is armed or, if under auto reset, that the door has been violated
- Various field-adjustable features by dip switch including automatic alarm reset, REX and passage time delay, and LED color preference
- A tamper switch provides instantaneous signal to sound horn in the event the cover is removed. Horn will sound until the unit is reset by the key or remote reset/arm switch
- Conformally coated electronics for weather resistance
- Cover is held in place by cam lock which protects mounting screws, electrical system and internal sensors
- Accepts external cylinder (not included, must be specified)
- Accepts standard mortise cylinders (not included, must be specified)

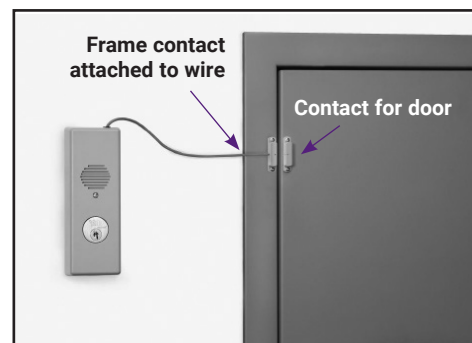

Note: Actual wire length is 6 feet.

**CYLINDERS**

**Rim**

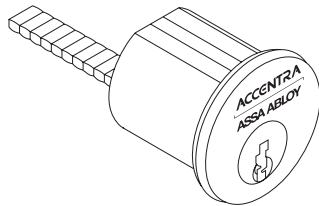

**Collar Requirements\***

Model #	Description	Pins	Length	420F	620F	630F	210F	121NL	SDA16 Outside	
1109	Standard Fixed Core	6	1-7/32"	599.419	No Collar	No Collar	1765.250	1765.250	1765.250	
1109	Standard Fixed Core	7	1-13/32"		KP4	KP4				
1709	CMK	6	1-11/32"	599.544	1765.250	1765.250	1765.500			
1709	CMK	7	1-1/2"			1765.406				
1193	LFIC Complete	6	1-7/16"			1765.250				1765.469
1193	LFIC Complete	7	1-5/8"	599.700	1765.344	1765.406	1765.656			
5109	Security Fixed Core	6	1-7/32"	599.419	No Collar	1765.250	1765.250			
5109	Security Fixed Core	7	1-13/32"			1765.250				
U5109	High Security Fixed Core	6	1-1/16"	NA		No Collar	No Collar			No Collar
U5109	High Security Fixed Core	7	1-1/8"		No Collar	No Collar				
5193	Security LFIC Complete	6	1-7/16"	599.544	1765.250	1765.250	1765.469	1765.250	1765.250	
5193	Security LFIC Complete	7	1-5/8"	599.700	1765.344	1765.406	1765.656			
K300	ASSA ABLOY ACCENTRA® KeyMark® Standard Fixed Core	6	1-1/8"	599.544	KP4	1765.250	1765.406			
K300	ASSA ABLOY ACCENTRA® KeyMark® Standard Fixed Core	7								
K840/ K880	ASSA ABLOY ACCENTRA® KeyMark® LFIC Complete / Housing Only	6	1-7/16"	599.700	1765.406	1765.500	1765.719			
K840/ K880	ASSA ABLOY ACCENTRA® KeyMark® LFIC Complete / Housing Only	7	1-5/8"	NA	1765.563	1765.719	1765.937			
K640/ K680	ASSA ABLOY ACCENTRA® KeyMark® SFIC Complete / Housing Only	6	1-1/4"	599.544	KP4	1765.250	1765.406			
K640/ K680	ASSA ABLOY ACCENTRA® KeyMark® SFIC Complete / Housing Only	6 or 7	1-3/8"	599.700	1765.187	1765.406	1765.563			
A640/ K680	Best® Keyway SFIC Complete / Housing Only	6	1-1/4"	599.544	KP4	1765.250	1765.406			
A640/ K680	Best® Keyway SFIC Complete / Housing Only	6 or 7	1-3/8"	599.700	1765.187	1765.406	1765.563			
2109	Schlage® "C" Keyway Fixed Core Available 0-bitted or keyed random.	6	1-7/32"	599.419	No Collar	No Collar	1765.250			

\*Based on 1-3/4" door thickness. Collar length required must be specified for cylinders and/or housings ordered separately.

LFIC = Large Format Interchangeable Core

SFIC = Small Format Interchangeable Core

## CYLINDERS

### Component

The following chart details component cylinders for use with 440F and 540F series trim.

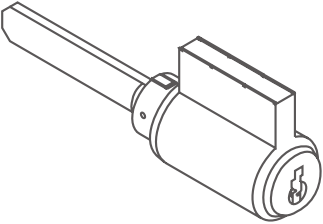

Model #	Description	Pins
1802	Standard Lever Fixed Core	6
1802A*	Standard Lever Fixed Core	7
5802	Security Lever Fixed Core	6
5802A*	Security Lever Fixed Core	7
1210	LFIC Only	6
1220*	LFIC Only	7
5210	Security LFIC Only	6
5220*	Security LFIC Only	7
K402*	ASSA ABLOY ACCENTRA® KeyMark® Lever Fixed Core	6 or 7
K800*	ASSA ABLOY ACCENTRA® KeyMark® LFIC Only	6 or 7
K600	ASSA ABLOY ACCENTRA® KeyMark® SFIC Only	6 or 7
A600	Best® Keyway SFIC Only	6 or 7
2802	Schlage® "C" Keyway Fixed Core. Available 0-bitted or keyed random.	6
3804 <sup>1</sup>	Corbin Russwin "L4", Corbin "60", Russwin "D1", Sargent® "LA" or Schlage® "E" Keyway Fixed Core. Specify keyway. Available keyed random	6

\*7-pin not available for 440F series trim. If 7-pin required, refer to 540F series.

<sup>1</sup>440 series trim requires the 108S kit. These cylinders are not ANSI/BHMA certified.

## CYLINDERS

### Mortise

The following chart details mortise cylinders for use with cylinder dogging, 2116 alarms, inside of SDA16 and KRM200 and KRM200SM mullions:

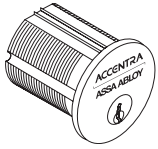

Model #	Description	Pins	Length	Cylinder Dogging**		2116 Alarm*		SDA16 Inside		KRM200 and KRM200SM	
				Cam	Collar	Cam	Collar	Cam	Collar	Cam	Collar
2153	Standard Fixed Core	6	1-1/8"	1161E	NA	No Collar	No Collar	No Collar	No Collar	2160	1765.312
2153	Standard Fixed Core	7	1-1/4"								1765.500
2196	LFIC Complete	6	1-1/2"		599.925	1765.250	KP4	1765.750			
2197	LFIC Complete	7	1-11/16"		599.1.04	1765.500	1765.250	1765.844			
5153	Security Fixed Core	6	1-1/8"		NA	No Collar	2160	No Collar	2160	2160	1765.312
5153	Security Fixed Core	7	1-1/4"								1765.500
U5153	High Security Fixed Core	6	1-1/8"		NA	NA	NA	NA	NA	NA	NA
U5153	High Security Fixed Core	7	1-1/4"								NA
5196	Security LFIC Complete	6	1-1/2"		599.925	1765.250	KP4	1765.750			
5197	Security LFIC Complete	7	1-11/16"		599.1.04	1765.500	1765.250	1765.844			
K100	ASSA ABLOY ACCENTRA® KeyMark® Standard Fixed Core	6 or 7	1-1/8"	Special	NA	No Collar	No Collar	No Collar	No Collar	KC1	1765.312
K820/ K860	ASSA ABLOY ACCENTRA® KeyMark® LFIC Complete / Housing Only	6	1-1/2"								599.925
K820/ K860	ASSA ABLOY ACCENTRA® KeyMark® LFIC Complete / Housing Only	7	1-11/16"		599.1.04	1765.500	1765.250	1765.000			
K620/ K660	ASSA ABLOY ACCENTRA® KeyMark® SFIC Complete / Housing Only	6	1-1/4"		599.700	KC1	No Collar	KC1	KC1	1765.500	
K620/ K660	ASSA ABLOY ACCENTRA® KeyMark® SFIC Complete / Housing Only	6 or 7	1-3/8"		599.850	1765.250	No Collar	No Collar	No Collar	No Collar	1765.563
A620/ K660	ASSA ABLOY ACCENTRA® Keyway SFIC Complete / Housing Only	6	1-1/4"		599.700	No Collar					No Collar
A620/ K660	Best® Keyway SFIC Complete / Housing Only	6 or 7	1-3/8"		599.850		No Collar	No Collar	No Collar	No Collar	
2553	Schlage® "C" Keyway Fixed Core. Available 0-bitted or keyed random.	6	1-1/8"		1161E	NA					2160

Based on 1-3/4" door thickness. Collar length required must be specified for cylinders and/or housings ordered separately.

LFIC = Large Format Interchangeable Core. SFIC = Small Format Interchangeable Core

NA = Application Not Available

\*2116 door alarm kit discontinued September 1, 2012

\*\*Cylinder dogging discontinued August, 2013

### Cams

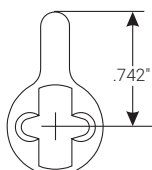

2160

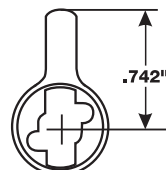

KC1

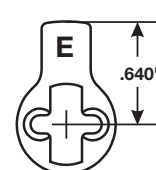

1161E

## COLLARS & TAILPIECES

### Cylinder Collars

If required, cylinder collar size must be specified.

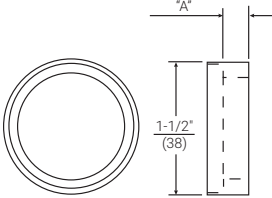
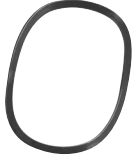
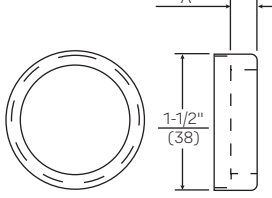
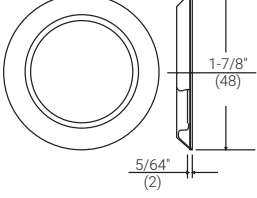
			
<p><b>1765 Recessed Cylinder Collar</b> <b>"A" Dimension:</b> Thicknesses from 1/16" (2mm) to 1-15/32" (37mm) as required. <b>Material:</b> Brass, Bronze</p>	<p><b>KP3 Wave Washer</b> (Furnished standard with 1765 collar for ASSA ABLOY ACCENTRA® KeyMark® cylinders and 630F series trim).</p>	<p><b>599 Recessed Cylinder Collar with Radius "A" Dimension:</b> Thicknesses from 1/16" (2mm) to 1-15/32" (37mm) as required. <b>Material:</b> Brass, Bronze</p>	<p><b>KP4 Flush Mount Cylinder Collar</b> <b>Material:</b> Brass, Bronze</p>

### Long Tailpiece Kit

Long tailpiece kit for use with escutcheon series trim, up to 4-1/2" thick doors. Specify part number to order.

Door Thickness	Trim Type	Part Number
2" - 2-1/2"	620F and 630F Series Trim	81-9500-1665-000
2-1/2" - 3-1/2"	620F and 630F Series Trim	81-9500-1635-000
3-1/2" - 4-1/2"*	620F and 630F Series Trim	81-9500-1636-000

\* Consult factory for doors over 3-1/2" thick

### Von Duprin® Tailpiece

This tailpiece is available for the ASSA ABLOY ACCENTRA® 1109 rim cylinder to operate the night latch function for Von Duprin® exit devices. To order, specify part number: 34-1145-1005-048.

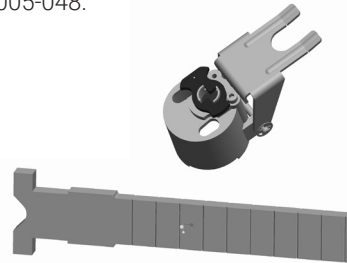

## STRIKES

### Rim Devices

<p><b>757F</b> Standard strike for 2100(F) and 2150(F) devices. Supplied with #10-24 x 3/4" machine screws, two shims (each 1/16" thick), and one locking plate.</p>	<p><b>757FWS</b> Standard strike for 2100(F)WS device. Supplied with 2 each #10-24 x 1-1/4" and 2 each #10-24 x 3/4" machine screws, two shims (each 1/16" thick), one locking plate and one interlocking bracket (not shown) with 4 each #10-24 x 3/4" machine screws.</p>	<p><b>793</b> Optional strike for double door applications without a mullion. Supplied with #10-24 x 3/4" machine screws, two shims (each 1/16" thick), and one locking plate. Panic only.</p>

### Vertical Rod Devices - Top Strikes

<p><b>791</b> Standard top strike for 2110(F), 2120(F), series devices. Supplied with #10-24 x 3/4" machine screws, two shims (each 1/16" thick), and one locking plate.</p>	<p><b>726</b> Standard top strike for 2170(F) series devices. Supplied with special #10-24 x 3/4" machine screws.</p>	<p><b>761</b> Standard top strike for 2160(F) series devices. Supplied with #10-32 x 3/8" machine screws and #10 x 1" sheet metal screws.</p>	<p><b>797</b> Optional bracket for mounting 791 top strike in flush transom opening. Supplied with 1/4-20 machine screws; SN-134 sex nuts, optional.</p>

### Vertical Rod Devices - Bottom Strikes

<p><b>790</b> Standard bottom strike for 2110(F), 2120(F), 2160(F), 2170(F) series devices. Press in place.</p>	<p><b>794</b> Optional bottom strike for fire openings using saddle thresholds or for flush floor mount. Must use for fire openings with 1/2" thresholds. Supplied with #10-24 x 1/2" machine screws and floor anchors.</p>	<p><b>702</b> Optional bottom strike for bottom pullman latch option. Supplied with #8 x 8/32" combination screws.</p>

## ACCESSORIES & OPTIONS

### Shim Kits

Shim kits are available for devices on doors with interfering molding. Each shim kit contains:

- 2 sets of 1/8" shims (shim up to 1/4")
- Longer fasteners
- Longer tailpiece for the trim
- Installation instructions
- 693 (Black) finish

**223** - Shim kit for 2100(F) rim, 2150(F) SquareBolt® and 2120(F) and 2160(F) series\* concealed vertical rod exit devices

**224** - Shim kit for 2110(F) and 2170(F) series surface vertical rod exit devices.

\*Special concealed vertical rod components needed for openings requiring more than (2) shim kits. Details on application.

### Extension Rods

2110 surface vertical rod devices are supplied standard for 7' (2.13m) standard. Rods may be field cut or used with extension rods for other heights. To order, specify:

Model Number	Length
2010-2	2" (51mm)
2010-6	6" (153mm)
2010-12	12" (305mm)
2010-24*	24" (610mm)

\*Used for 10' door applications with 2170(F90)

### Specialty Fasteners

#### Sex Nuts:

Required for wood, composite or unreinforced metal doors.

To order specify:

- **SN-104** – pack of (4) 10-24 sex nuts for all fire rim exits
- **SN-134** – pack of (4) 1/4-20 sex nuts for all devices

#### Wood Door Fasteners:

For solid core wood doors, permitted if pilot holes are used to install screws. Consult the factory for availability.

Torx® Security Screws available for factory product orders.

### Bottom Pullman Latch

Optional bottom Pullman latch available for panic-listed vertical rod exit devices. To order with devices, specify "BPL." 702 bottom strike required, see page 30.

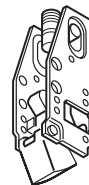

### Wide Stile Cover

2100 series devices are available with an optional wide stile cover. To order with device, specify option: "WIDE".



To order cover separately, specify part number:

60-2000-1241 x Finish = for use with 2100

60-2150-1244 x Finish = for use with 2150

60-2110-1243 x Finish = for use with 2110 & 2170

60-2000-1240 x Finish = for use with 2120 & 2160

### Plastic Installation Template

Provided as a standard with all 2100 series exit device, the plastic installation template facilitates door markings over traditional paper templates. This provides a more accurate door prep which reduces installation mistakes and overall installation time. Template dimensions: 8-1/4" x 3-1/4" (210mm x 83mm). To order separately, specify part number: 60-7000-9100-999.



### Schlage® Cam Assembly

This cam and housing assembly includes a cam engineered to accept Schlage® rim cylinders. No modifications are required to existing 500 and 600 series exit device trims thus maintaining the trim's classroom and storeroom functions. To order, specify part number: 60-7000-0815.

## MULLIONS

### M200(F) Removable Mullion

M200(F) steel mullions are for use with 2100(F) series exit devices. Mullions may be field cut to fit opening. Gray paint finish.

- M200 panic rated.  
Tubular steel, 2" x 3" (51mm x 76mm). Specify 7'2".
- M200F 3 hour fire rated.  
Tubular steel, 2" x 3" (51mm x 76mm). Specify 7'2" or 10'<sup>1</sup>  
(Fire rated up to 8').
- M200FWS 3 hour fire rated.  
Certified hurricane resistant (refer to local codes).  Hurricane  
Tubular steel, 2" x 3" (51mm x 76mm). Specify 7'2" or 8'.

**Notes:**

1. For 8' length Mullion must be order as M200F option and cut in the field to 8' size.

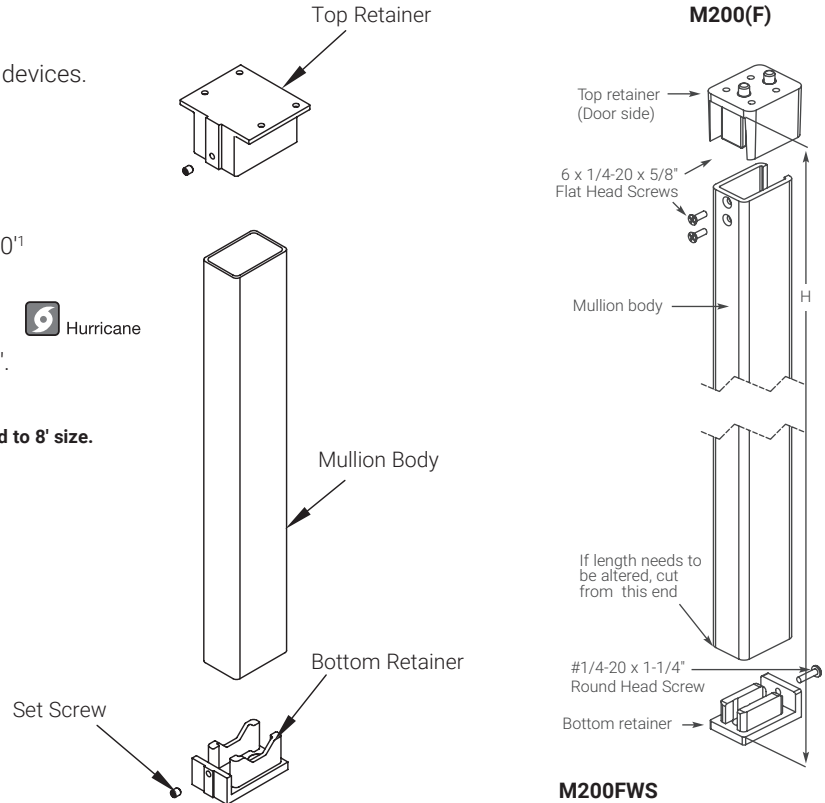

### M200(F) Options

- **M203 Spacer Block**  
Recommended for double rabbeted frames where the stop face width is less than the mounting hole spacing or for applications with 5-3/4" (146mm) or less door frames.

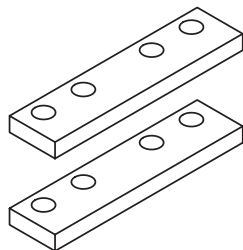

- **M204 Angle Bracket**  
Recommended for any header configuration with less than 3" (76mm) of mounting surface.

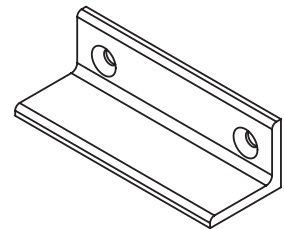

## MULLIONS

### KRM200(F) Keyed Removable Mullion (KRM)

Keyed removable mullions are for use with 2100(F) series exit devices. They are designed for simple removing when an unobstructed large opening is required and easy replacement and locking to maintain the integrity of the opening.

- KRM200 panic rated. Specify 7'2".
- KRM200F 1-1/2 hour fire rated. Specify 7'2" or 10'1" (fire rated up to 8').
- KRM200FWS 3 hour fire rated. Certified hurricane resistant (refer to local codes).  Hurricane Specify 7'2" or 8'.
- Easy cylinder installation.
- Mullion automatically relocks when reinstalled without the use of the cylinder key.
- When ordering, add KR prefix to mullion, example: KRM200 and KRM200F.

**Notes:**

1. For 8' length Mullion must be order as KRM200F option and cut in the field to 8' size.

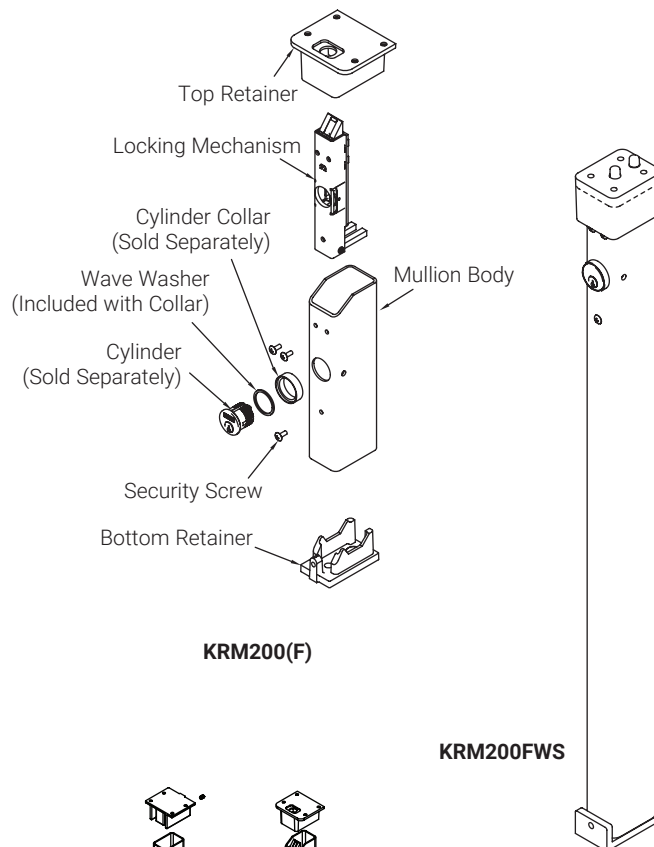

### Split Mullion

- Hassle-free transportation with a 30% smaller packaging size. Mullions may be field cut to fit opening. Gray painted finish. Available only in 8'. When ordering add suffix SM, example M200SM and KRM200SM

**M200SM Standard**

- Panic rated. Specify 8'
- Tubular steel, 2" x 3" (51mm x 76mm).

**KRM200SM Key Removable Split Mullion**

- Easy cylinder installation.
- Panic rated. Specify 8'
- Tubular steel, 2" x 3" (51mm x 76mm).

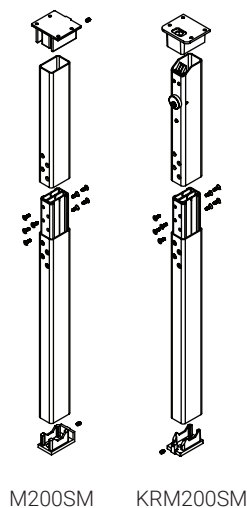

## MULLION CYLINDER KIT AND OPTIONS

### KRM Options

- **M203 Spacer Block**

Recommended for double rabbeted frames where the stop face width is less than the mounting hole spacing or for applications with 5-3/4" (146mm) or less door frames.

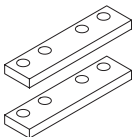

- **M204 Angle Bracket**

Recommended for any header configuration with less than 3" (76mm) of mounting surface.

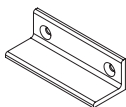

Mullion Cylinder Kit	Available with the following mullions series
AMCK1	KRM200
	KRM200F
	KRM200SM
AMCK2	KRM200FWS

Note: Mullion cylinder kit contains washer, collar and cylinder  
\*Specify finishes and cylinder keyed code when ordering

EX: AMCK1 X FINISH X CYLINDER KEYED CODE  
(i.e. AMCK1 X 630 X CT6)

Keyed Codes	Description
CT6	LFIC Complete, 6 Pin
CT6LL	ASSA ABLOY ACCENTRA® KeyMark® LFIC w/Temp LFIC, 6 Pin
CT6SD	ASSA ABLOY ACCENTRA® KeyMark® SFIC w/Temp Disposable SFIC, 6 Pin
CT6SL	ASSA ABLOY ACCENTRA® KeyMark® SFIC w/Temp Lockable SFIC, 6 Pin
CT7	LFIC Complete, 7 Pin
CT7LL	ASSA ABLOY ACCENTRA® KeyMark® LFIC w/Temp LFIC, 7 Pin
CT7SD	ASSA ABLOY ACCENTRA® KeyMark® SFIC w/Temp Disposable SFIC, 7 Pin
CT7SL	ASSA ABLOY ACCENTRA® KeyMark® SFIC w/Temp Lockable SFIC, 7 Pin
CY	Standard Fixed Core
ICLC	LFIC, Less Core
KM	ASSA ABLOY ACCENTRA® KeyMark® Standard Fixed Core
KMLIC	ASSA ABLOY ACCENTRA® KeyMark® LFIC Complete
KMLICH	ASSA ABLOY ACCENTRA® KeyMark® LFIC Housing Only
KMSIC	ASSA ABLOY ACCENTRA® KeyMark® SFIC Complete
KMSICH	ASSA ABLOY ACCENTRA® KeyMark® SFIC Housing Only
S	Security Fixed Core
SC	Schlage® "C" Keyway Fixed Core
SFIC	Best® Keyways SFIC Complete
SFICLC	Best® Keyway SFIC Housing Only
SIC	Security LFIC Complete

## DIMENSIONS

### Device

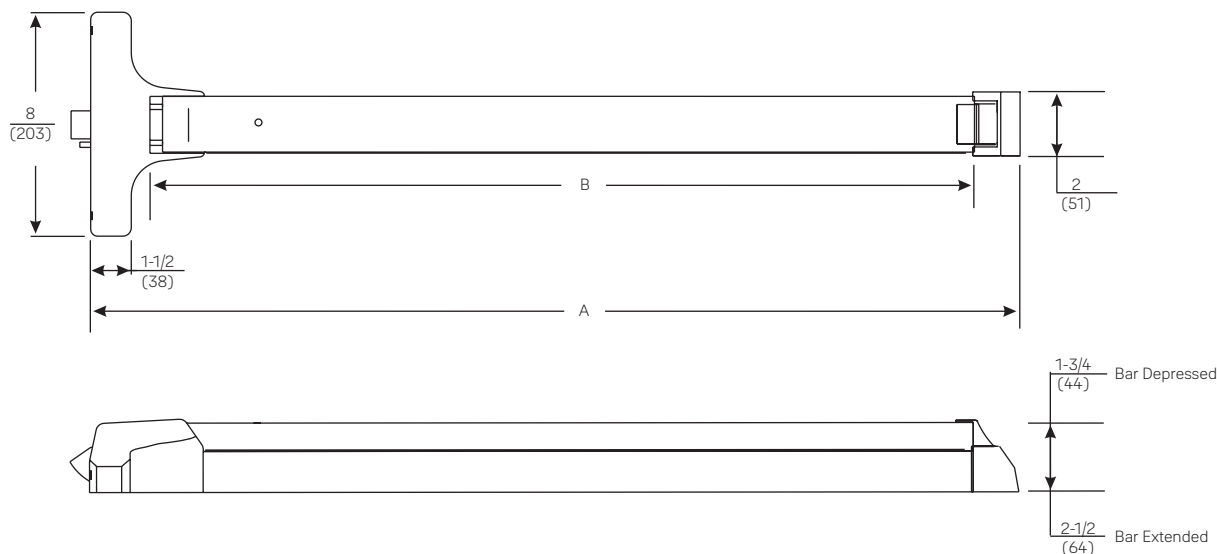

Dimensions are in: inches (mm)

Device Size	"A"	"B"
36"	32-3/8" (82cm)	27" (69cm)
42"	38-3/8" (98cm)	33" (84cm)
48"	44-3/8" (113cm)	39" (99cm)

### Trim Dimensions

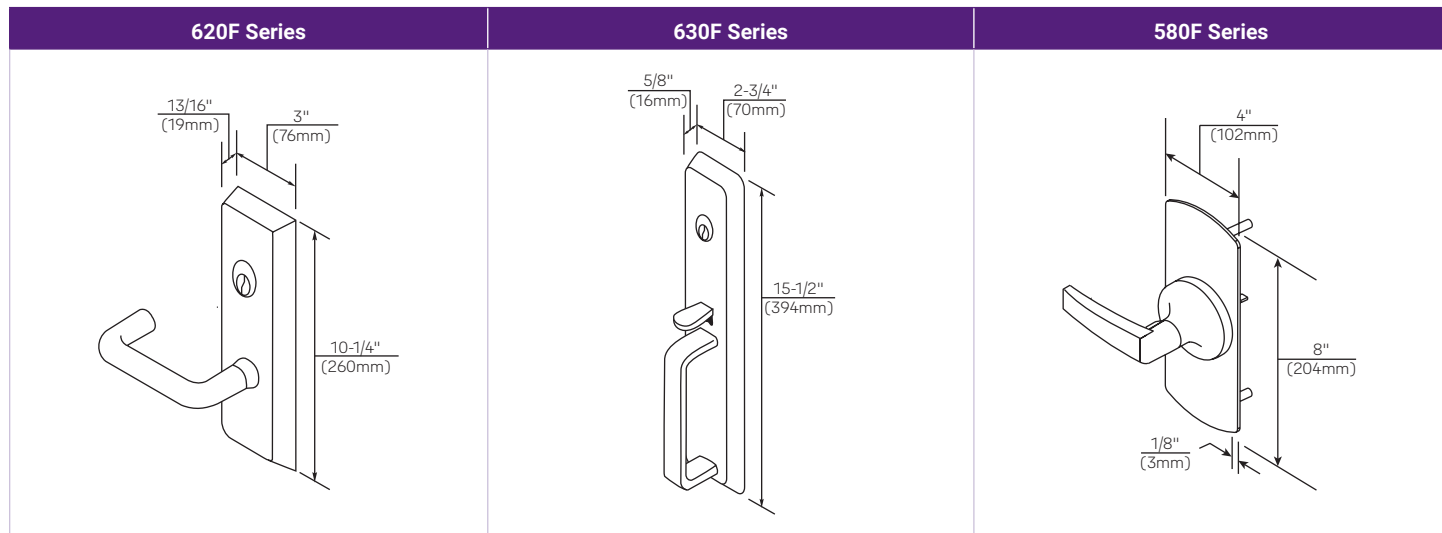

## SAMPLE SPECIFICATION

Exit devices shall be 2100 Series Pushpad Exit Devices as manufactured by ASSA ABLOY ACCENTRA®.

The exit device chassis and push pad assembly shall be of high-grade non-ferrous steel material, electroplated for protection against rust, and shall have a baked powder coating. The maximum projection shall be 2-1/2" when the push pad is active and 1-3/4" when the push pad is dogged down. Nylon bearings and stainless steel springs shall be used for long life and durability; only torsion springs are acceptable. Rear and active case covers shall be steel and shall have a baked powder coating to match the exit bar. Plastic covers are not acceptable. Latchbolts shall be steel and shall incorporate a deadlocking latch for increased security. Devices without deadlocking latches are not acceptable. Mounting screws shall be concealed to deter tampering. Devices shall be closed on all sides with no pinch points. Exit devices shall be easily field sized to accommodate various door widths.

Panic-listed exit devices shall have single point, one quarter turn hex key dogging standard. Panic-listed devices shall be available less dogging.

Trims shall be through-bolted with concealed fasteners. Escutcheon and pull-type trims shall be constructed of brass, bronze or zinc. All lever trims shall use cast or forged levers. On rim and vertical rod trims with cylinders, the mechanism that locks and unlocks the trim shall be housed in the trim and not in the active case of the exit device. Lever trims shall be Free Wheeling with clutch mechanism allowing lever to rotate 60° when locked for ideal protection. Lever trims shall match those on ASSA ABLOY ACCENTRA® mortise and cylindrical locksets.

Exit devices and trims shall be furnished in ANSI/BHMA standard architectural finishes. Exit devices shall be listed by Underwriters Laboratories (UL, cUL) for safety as panic hardware. Fire-rated devices shall be listed for "A" label and lesser class doors. Devices shall also be UL listed for ZHEM - latching hardware.

**Certification:**

ANSI/BHMA A156.3, Grade 1

Devices, trims and cylinders shall be from one manufacturer. Devices shall carry a three-year warranty and escutcheon trims shall carry a five-year warranty.

## TECHNICAL SPECIFICATIONS & LISTINGS

### ANSI/BHMA

Certified ANSI/BHMA A156.3, Grade 1.



### Fire Listings

2100F series exit devices are UL-cUL Listed for use on fire doors having a rating up to and including 3-hours unless otherwise noted.

Note: Any retrofit or other field modification to a fire rated opening can potentially impact the fire rating of the opening, and ASSA ABLOY ACCENTRA® makes no representations or warranties concerning what such impact may be in any specific situation. When retrofitting any portion of an existing fire rated opening, or specifying and installing a new fire-rated opening, please consult with a code specialist or local code official (Authority Having Jurisdiction) to ensure compliance with all applicable codes and ratings.

### Free Wheeling Lever Trim

2100 exit device lever trims feature the unique Free Wheeling lever mechanism. This Free Wheeling trim features a clutch mechanism which allows the lever to float down 60° when operated in the locked condition, greatly improving vandal resistance.

### Windstorm

Certified (refer to local codes). Specify suffix "WS" to 2100(F) device.



### ISO 9001

Designed and manufactured under a certified ISO 9001 quality system.

### Warranty

The 2100 series exit devices carry a three-year warranty. Rose trims carry a two or three-year warranty and escutcheon trims carry a five-year warranty.

### Microshield®

2100 series exit devices and trims are available with MicroShield antimicrobial coating. MicroShield is a revolutionary hardware finish coating which inhibits the growth of bacteria, algae, yeast fungus, mold and mildew. MicroShield is non-toxic and lasts for the lifetime of the finish to which it is applied. To order, suffix option code "YMS".

Note: MicroShield coating may vary finish color from architectural standards. MicroShield is not intended as a substitute for traditional infection control programs such as hand hygiene or use of disinfectants. Coated products must still be cleaned to insure the surfaces will be free of destructive microbes. ASSA ABLOY ACCENTRA® makes no representations or warranties, express or implied, as to the efficacy of the MicroShield antimicrobial. A copy of the MicroShield warranty is available upon request.

The ASSA ABLOY Group is the global leader in access solutions.  
Every day, we help billions of people experience a more open world.

ASSA ABLOY Opening Solutions leads the development within door openings and products for access solutions in homes, businesses and institutions. Our offering includes doors, frames, door and window hardware, mechanical and smart locks, access control and service.

**ACCENTRA®**  
**ASSA ABLOY**

**TECHNICAL SUPPORT**

(troubleshooting, product use and application, returns)

Tel: 855-557-5078

Email: [techsupport.accentra@assaabloy.com](mailto:techsupport.accentra@assaabloy.com)

**CUSTOMER SUPPORT**

(orders, product configuration, pricing, lead-time)

Tel: 855-557-5078 x2

Email: [Customerservice.Accentra@assaabloy.com](mailto:Customerservice.Accentra@assaabloy.com)

**U.S.A.:**

ASSA ABLOY ACCENTRA®

225 Episcopal Road  
Berlin, CT 06037-4004

Tel: 1-800-438-1951

Fax: 1-800-338-0965

[www.accentra-assaabloy.com](http://www.accentra-assaabloy.com)

**Canada:**

ASSA ABLOY Door Security Solutions Canada

160 Four Valley Drive  
Vaughan, Ontario L4K 4T9

Tel: 1-800-461-3007

Fax: 1-800-461-8989

[assaabloydss.ca](http://assaabloydss.ca)

**International:**

ASSA ABLOY Americas International

Tel: 1-905-821-7775

Fax: 1-905-821-1429

[assaabloyai.com](http://assaabloyai.com)