

**ACCENTRA®**

**ASSA ABLOY**

Experience a safer  
and more open world

# 1800 SERIES

## Flatbar Exit Device



## TABLE OF CONTENTS

### Contents

<a href="#">Introduction</a>	<a href="#">3</a>
<a href="#">Benefits &amp; Features</a>	<a href="#">4</a>
<a href="#">Finishes</a>	<a href="#">5</a>
<a href="#">How to Order</a>	<a href="#">6</a>
<a href="#">1800(F) Rim</a>	<a href="#">7</a>
<a href="#">1810(F) Surface Vertical Rod</a>	<a href="#">8</a>
<a href="#">Trim Designs</a>	<a href="#">9-12</a>
<a href="#">Functions</a>	<a href="#">13</a>
<a href="#">Applications</a>	<a href="#">14</a>
<a href="#">Cylinders</a>	<a href="#">15-16</a>
<a href="#">Strikes</a>	<a href="#">17</a>
<a href="#">Accessories</a>	<a href="#">18</a>
<a href="#">Mullions</a>	<a href="#">19-21</a>
<a href="#">Dimensions</a>	<a href="#">22</a>
<a href="#">Technical Specifications &amp; Listings</a>	<a href="#">23</a>

### 1800 Flatbar Exit Devices

ASSA ABLOY ACCENTRA® 1800 Series Exit Devices are the ideal choice for economy commercial applications where you need consistent quality, dependability and ease of use and installation. The 1800 Series is ANSI/BHMA certified Grade 1, with durable construction and versatile mounting applications, making it ideal for a variety of facilities.

### **WARNING**

This product can expose you to lead which is known to the state of California to cause cancer and birth defects or other reproductive harm. For more information go to [www.P65warnings.ca.gov](http://www.P65warnings.ca.gov).

## INTRODUCTION

ASSA ABLOY ACCENTRA® offers innovative and reliable products to solve the challenges of commercial, retail, hospitality, assisted living, mixed-use, and multi-family properties. Our door hardware expertise extends beyond products to people - and provides the service and support you expect.

Featuring durable products to meet all your facilities' requirements - and the quality you expect from a leader in the hardware industry.

ASSA ABLOY ACCENTRA® Exit Devices			
7000 Series	6000 Series	2100 Series	1500 Series
			
 <ul style="list-style-type: none"> <li>• Ideal for facilities that require durability and innovation to meet their security needs</li> <li>• Wide &amp; Narrow Stile Applications</li> <li>• Rim, SquareBolt, Mortise, SVR &amp; CVR</li> <li>• Mechanical &amp; Electro-Mechanical Functions</li> <li>• Available with Motorized Electric Latch Retraction</li> <li>• Constructed with high quality steel and heavy-duty components</li> <li>• 16 Standard finishes including BSP (Black Suede Powder Coat)</li> <li>• ANSI/BHMA Certified Grade 1</li> <li>• UL Rated for Panic &amp; Fire, Windstorm Rated Options (refer to local codes)</li> <li>• 5 Year Warranty and Two-Year Limited Warranty on Electronic Components</li> </ul>	 <ul style="list-style-type: none"> <li>• Ideal for facilities that require modern form and full functionality to meet their life safety needs</li> <li>• Wide &amp; Narrow Stile Applications</li> <li>• Rim, Squarebolt, CVR, SVR &amp; Mortise</li> <li>• Mechanical &amp; Electro-Mechanical Functions</li> <li>• Available with Motorized Electric Latch Retraction</li> <li>• Aluminum rail assembly with Architectural Metals</li> <li>• Solid Cast Flush End Cap</li> <li>• ANSI/BHMA Certified Grade 1</li> <li>• UL Rated for Panic &amp; Fire</li> <li>• 10 Year Warranty and Two-Year Limited Warranty on Electronic Components</li> </ul>	 <ul style="list-style-type: none"> <li>• Ideal for commercial applicatons and budget conscious end users</li> <li>• Wide Stile Applications</li> <li>• Rim, Squarebolt, CVR &amp; SVR</li> <li>• Mechanical Functions</li> <li>• ANSI/BHMA Grade 1 Certified</li> <li>• UL Rated for Panic &amp; Fire</li> <li>• Architectural &amp; Painted Finishes</li> <li>• 3 Year Warranty</li> </ul>	 <ul style="list-style-type: none"> <li>• Ideal for renovation projects where historical preservaton is the desired look</li> <li>• Wide Stile Applications</li> <li>• Rim, CVR, SVR &amp; Mortise</li> <li>• ANSI/BHMA Certified Grade 1</li> <li>• UL Rated for Panic &amp; Fire</li> <li>• Architectural &amp; Painted Finishes</li> <li>• 1 Year Warranty</li> </ul>

## BENEFITS & FEATURES

### Benefits





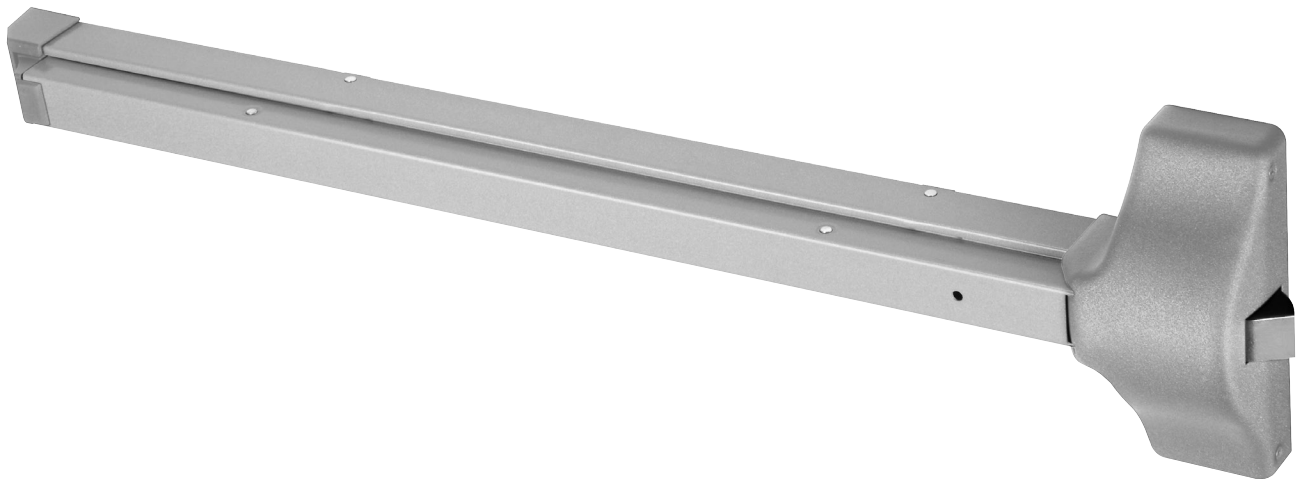

- **Tough:** Sturdy construction is ideal for meeting the rigors of demanding industry environments
- **Versatile:** Available in multiple finishes for both front and back of house applications
- **Economical:** Works for a variety building projects, regardless of budget
- **Strong & Durable:** ANSI/BHMA Grade 1 Certification ensures long life and reliability

### Features

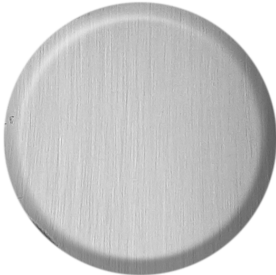
- High-grade steel components offer superior protection against wear & tear
- Available in a variety of functions and finishes for any application
- ANSI/BHMA Grade 1 certified **BHMA CERTIFIED**
- UL/cUL listed for fire rated doors
- Three year warranty



**FINISHES**

ANSI/BHMA Code Finish Description		
<b>626*</b> <b>Satin Chrome Plated</b> <b>(Trim Only)</b>	<b>630*</b> <b>Satin Stainless Steel</b> <b>(Trim Only)</b>	<b>689</b> <b>Aluminum Painted</b>
		
<b>691</b> <b>Light Bronze Painted</b>	<b>693</b> <b>Black Painted</b>	<b>695</b> <b>Dark Bronze Painted</b>
		

\*Finish available with MicroShield® antimicrobial coating, additional finishes by special application. Consult factory for availability.

MicroShield coating may vary finish color from architectural standards. MicroShield is not intended as a substitute for traditional infection control programs such as hand hygiene or use of disinfectants. Coated products must still be cleaned to ensure the surfaces will be free of destructive microbes. ASSA ABLOY ACCENTRA® makes no representations or warranties, express or implied, as to the efficacy of MicroShield.



## 1800(F) RIM

The 1800(F) is a rim exit device to be used with single doors or pairs of doors constructed of metal, wood or composite materials. The 1800(F) can be paired with a wide variety of trims to meet many applications.

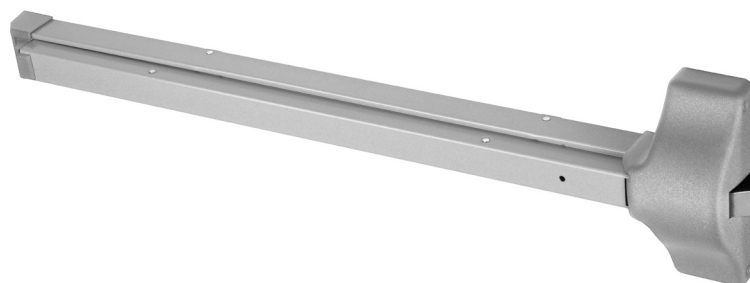

### Certification/Compliance

UL/cUL Listed: FVSR/FVSR7 - Panic hardware  
GXHX/GXHX7 - Fire exit hardware (F)  
(up to 4' x 8' single, 8' x 8' pairs, 3 hr.)

ANSI/BHMA Certified: A156.3 Type 1, Grade 1



### Features

- Designed for wide stile doors
- Non-handed for easy installation
- Steel interlock "E" bracket maintains door-to-mullion relationship in fire-labeled devices

### Applications

- Single swing doors
- Pairs of doors (mullion required)
- Metal, wood or composite door materials

### Specifications

<b>Door Opening Width</b>	-36 for 30" - 36" (76cm - 91cm) doors -42 for 36" - 42" (91cm - 107cm) doors -48 for 42" - 48" (107cm - 122cm) doors
<b>Door Thickness</b>	1-3/4" (44mm) standard. Refer to page 18 for other door thicknesses
<b>Minimum Stile Width</b>	4-1/2" (114mm)
<b>Projection</b>	2-1/2" (64mm) active, 1-3/4" (44mm) depressed
<b>Strike</b>	757F, 793 optional (double door application)
<b>Trims</b>	210F series utility trim, 420F series escutcheon trim, 440F series rose trim
<b>Dogging</b>	Hex key dogging supplied standard on panic devices
<b>Finishes</b>	689, 691, 693, 695
<b>Options</b>	Shim Kit #223, Sex Nuts and Bolts
<b>Warranty</b>	3-year limited

## 1810(F) SURFACE VERTICAL ROD

The 1810(F) is a surface vertical rod exit device to be used on metal, wood or composite pairs of doors up to 8' where two-point latching is desired.

### Certification/Compliance

UL/cUL Listed: FVSR/FVSR7 - Panic hardware  
GXHX/GXHX7 - Fire exit hardware (F)  
(up to 4' x 8' single, 8' x 8' pairs, 3 hr.)

ANSI/BHMA

Certified: A156.3 Type 2, Grade 1

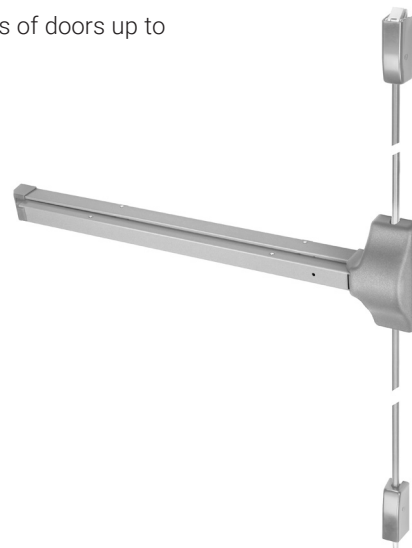

### Features

- Designed for wide stile and flush doors
- Handed, specify hand (field reversible)
- Positive action linkage on a deadlocking top Pullman bolt
- Simultaneous direct pull bottom deadbolt
- When unlatched, device keeps both bolts retracted until door is shut

### Applications

- Pairs of doors
- Double egress
- Metal, wood or composite door materials

### Specifications

<b>Door Opening Width</b>	-36 for 30" - 36" (76cm - 91cm) doors -42 for 36" - 42" (91cm - 107cm) doors -48 for 42" - 48" (107cm - 122cm) doors
<b>Door Opening Height</b>	Standard door height 7' (213cm), with the device centerline at 39-15/16" (101cm) from floor Optional heights up to 8' (244cm) by using rod extensions
<b>Door Thickness</b>	1-3/4" (44mm) standard. Refer to page 18 for other door thicknesses
<b>Minimum Stile Width</b>	4-1/2" (114mm)
<b>Projection</b>	2-1/2" (64mm) active, 1-3/4" (44mm) depressed
<b>Strike</b>	Top: Roller type 791. Bottom: Flush mounted 790. 794 floor strike optional (threshold openings), 702 optional (Bottom Pullman Latch)
<b>Trims</b>	210F series utility trim, 420F series escutcheon trim, 440F series rose trim
<b>Dogging</b>	Hex key dogging supplied standard on panic devices
<b>Finishes</b>	689, 691, 693, 695
<b>Options</b>	Shim Kit #224, Sex Nuts and Bolts, Bottom Pullman Latch (panic only)
<b>Warranty</b>	3-year limited

**TRIM DESIGNS**

**Escutcheons**



**Roses**

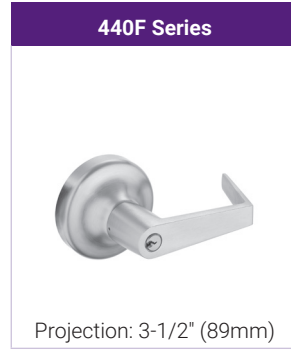

**Plate Trim**



**Standard Levers**

AU Augusta 	MO Monroe 	PB Pacific Beach 
 <p>Projection: 2-5/16" (59mm)</p>	 <p>Projection: 2-3/16" (71mm)</p>	 <p>Projection: 2-3/4" (70mm)</p>

## TRIM DESIGNS

### 420F Series Wide Escutcheon Trim



- Certified ANSI/BHMA A156.3, Grade 1 **BHMA CERTIFIED**
- Trim through-bolts to exit device for strength
- Strong cast zinc escutcheon
- Thru-bolt. 1-3/4" (44mm) door standard. For doors thru 2-1/4" (57mm) or shim-mounted devices, specify on order.
- Dimensions: 2-1/2" x 9-1/2" x 7/16" (64mm x 241mm x 11mm)
- Available only with AU/MO/PB levers
- Cylinders not included. For rim cylinders, see page 26.
- Finishes: 626, 689, 691, 693 and 695
- 1-year warranty
- **Ordering Example: PB428F x LHR x 689**

Application	Cylinder	Exit Only Blank Plate	Nightlatch	Classroom/ Storeroom	Nightlatch	Dummy Free Wheeling	Passage	Dummy Rigid Lever
1800(F) 1810(F)	Rim	420F	421F*	426F	427F*	428F	428F	429F
ANSI		01	03	08/09	03	02	14	02

**\*Not recommended for use with 1810(F) surface vertical rod exit devices.**  
**Note: 09 and Free Wheeling 02 achieved with single trim modification at installation.**

**TRIM DESIGNS**

**440F Series Rose Trim**



- Certified ANSI/BHMA A156.3, Grade 1. **BHMA CERTIFIED**
- 440F rose trim for stock doors (161 Prep).
- 1-3/4" (44mm) door standard. For doors thru 2-1/4" (57mm) or shim-mounted devices, specify on order.
- Cylinders included, accepts component cylinders. See pages 15-16.
- Finishes: 626, 689, 691, 693, 695.
- "B" trim prefix – Lever trim accepting small format interchangeable cores (SFIC). Specify 6- or 7-pin. (Example: B-AU446F)
- 2-year warranty.
- Ordering example: AU446F x RHR x 693.

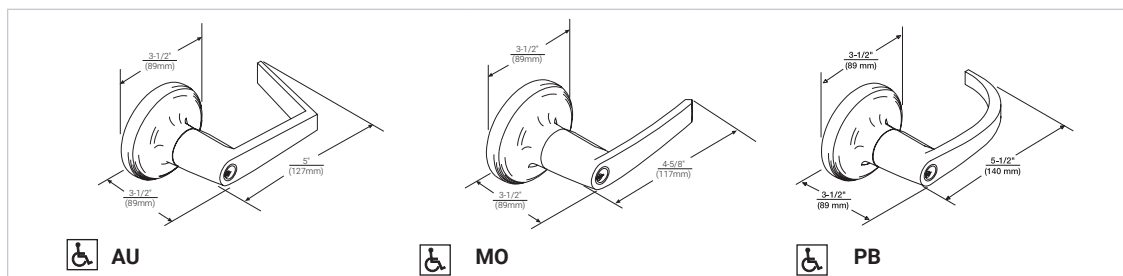

Application	Nightlatch Access by Key	Classroom	Dummy Trim Free Wheeling Lever	Passage Lever	Dummy Trim Rigid Lever
1800(F) 1810(F)	441F*	446F	448F	448F	449F
ANSI	03	08	02	14	02

**\*Not recommended for use with vertical rod exit devices.**

**TRIM DESIGNS**

**210F Series Trim**

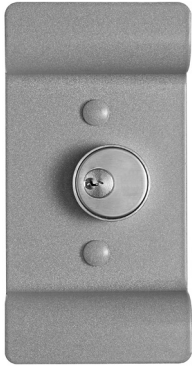

- Thrubolted. 1-3/4" (44mm) door standard. For doors thru 2-1/4" (57mm) or shim-mounted devices, specify on order.
- Plate Dimensions: 3-1/2" x 3-3/4" x 3/32" (89mm x 95mm x 2mm).
- Finger Pull Dimensions: 3-1/2" x 6-3/4" x 1/8" (89mm x 171mm x 3mm).
- Cylinders not included. For rim cylinder options, see pages 15-16.
- Finishes: 689, 691, 693, 695.
- 1-year warranty.

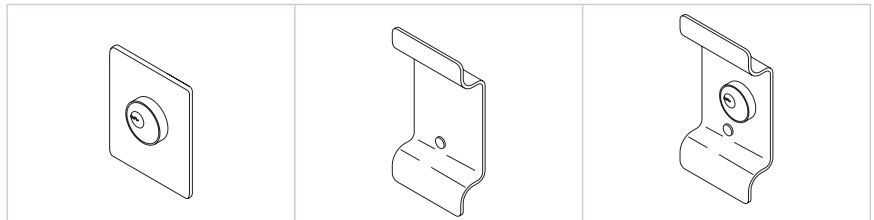





Application	Cylinder	Nightlatch Access by Key	Dummy Trim Pull Plate	Nightlatch Cylinder x Pull
1800(F) 1810(F)	Rim	213F*	214F	217F*
ANSI		03	02	03

**\*Not recommended for use with 1810(F) surface vertical rod exit devices.**

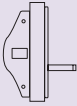
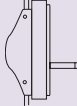
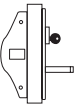
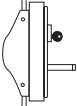
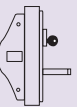

## FUNCTIONS

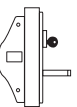
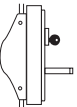
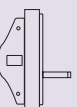
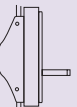
ANSI types 1 (Rim) and 2 (Surface Vertical Rod) exit device requirements are met (or exceeded) by 1800(F) and 1810(F) respectively. Any of these exit devices may be used with any of the trim on the following chart. Trims are charted according to ANSI trim function and illustrations show typical function features, rather than pictorial renderings of the trims listed. Specific trim details are shown on pages 9-12.

Trim	Device (ANSI)	Rim (Type 1)		SVR (Type 2)	
	Options	1800(F) (Page 7)		1810(F) (Page 8)	
ANSI	Function				
01	Exit Only, No Trim/Exit Only, Blank Plate		420F		420F
02	Pull to Open (Dummy Trim)		214F 448F* 428F* 449F* 429F		214F 448F* 428F* 449F* 429F
03	Key Retracts Latchbolts (NL)		213F 427F 217F 441F 421F		213F 427F 217F 441F 421F
08	Entrance by Lever (Key Locks/Unlocks Lever)		426F 446F		426F 446F
09	Key Unlocks Lever (Key Removable When Locked)		426F*		426F*
14	Lever Always Active (Passage)		428F 448F		428F 448F

\*Trims marked with an asterisk on the Application Chart require an easy field change to adapt them for the charted function.

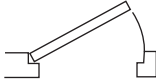
**APPLICATIONS**

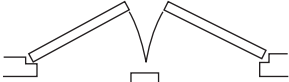
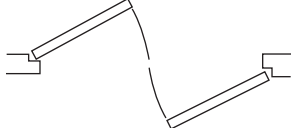
Single Door	Pairs of Doors
 <p><b>Rim Exit Device</b></p> <ul style="list-style-type: none"> <li>• ANSI/BHMA A156.3 Type 1</li> <li>• Easy installation</li> <li>• Flush or wide stile metal, wood or composite doors</li> <li>• Non-handed</li> <li>• Exit only or with entry trim</li> </ul>	 <p><b>One Rim - One Vertical Rod Exit Device</b></p> <ul style="list-style-type: none"> <li>• An economic solution for light traffic openings</li> <li>• Flush or wide stile metal, wood or composite doors</li> <li>• Non-handed</li> <li>• Emergency exit only</li> </ul>
Pairs of Doors with Center Mullion	Pairs of Doors or Double Egress Opening
 <p><b>Two Rim Exit Devices - One Removable Mullion</b></p> <ul style="list-style-type: none"> <li>• ANSI/BHMA A156.3 Type 1 and Type 22</li> <li>• Easy installation</li> <li>• Flush or wide stile metal, wood or composite doors</li> <li>• Non-handed</li> <li>• Exit only or with entry trim</li> </ul>	 <p><b>Two Surface Vertical Rod Exit Devices</b></p> <ul style="list-style-type: none"> <li>• ANSI/BHMA A156.3 Type 2</li> <li>• Two-point latch security</li> <li>• Flush or wide stile metal, wood or composite doors</li> <li>• Smoke control or fire exits</li> <li>• Two-way traffic control</li> </ul>

## CYLINDERS

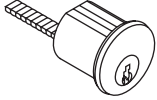
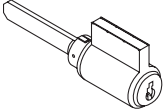
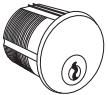
Illustration	Type	Model Number	Number of Pins
	Cylinder used for trim series 210F and 420F	1109	6
	Cylinder used for trim series 440F	1802	6
	Cylinder used for KRM200SM and KRM200(F)	2153	6

### Keying

All cylinders furnished standard 6-pin, keyed random in ASSA ABLOY ACCENTRA® PARA keyway, pinned to ASSA ABLOY ACCENTRA® .019" specification. Each cylinder furnished with two nickel silver keys.

### Options



Cylinders available 0-bitted, keyed alike, master keyed or construction master keyed upon request.

### Small Format Interchangeable Core (SFIC)

Model/ Prefix	Description	Length	Number of Pins (Specify)		Ordering Example
			6-Pin	7-Pin	
B-	Prefix for cylindrical lever with SFIC prep. Less core. For use with 440F series trim.	—	—	—	B-AU446F x 693
K680	Rim SFIC housing only. For use with 210F and 420F series trim.	1-1/4"	X	—	AU426F x K680 x 1-1/4" x 693
		1-3/8"	X	X	
K660	Mortise SFIC housing only. For use with Key Removable Mullion.	1-1/4"	X	—	KRM200F x K660 x 1-1/4"
		1-3/8"	X	X	

**CYLINDERS**

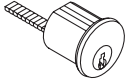
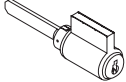
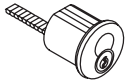
**Competitor Keyway Cylinders/Cores**

Illustration	Type	Model Number	Number of Pins
	Best® Keyway Core. Available keyed random, master keyed or uncombined. Specify keyway A, B, C, D, E, F, G, H, J, K, L or M.	A600	6 or 7
	Schlage® "C" Keyway Cylinder. For use with 210F and 420F series trim. Available 0-bitted or keyed random.	2109	6
	Schlage® "C" Keyway Cylinder. For use with 440F series trim. Available 0-bitted or keyed random.	2802	6
	Rim SFIC Cylinder. Includes Best Keyway Core. For use with 210F and 420F series trim. Available keyed random, master keyed or uncombined. Specify keyway A, B, C, D, E, F, G, H, J, K, L or M.	A640	6 or 7 Specify Length: 1-1/4" (6-pin only) 1-3/8" (6- or 7-pin)
	Mortise SFIC Cylinder. Includes Best® Keyway Core. For use with Key Removable Mullion. Available keyed random, master keyed or uncombined. Specify keyway A, B, C, D, E, F, G, H, J, K, L or M.	A620	6 or 7 Specify Length: 1-1/4" (6-pin only) 1-3/8" (6- or 7-pin)
	Schlage® "C" Keyway Cylinder. For use with Key Removable Mullion. Available 0-bitted or keyed random.	2553	6

## STRIKES

### Rim Devices

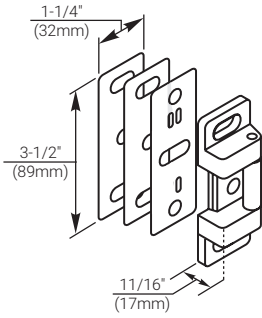
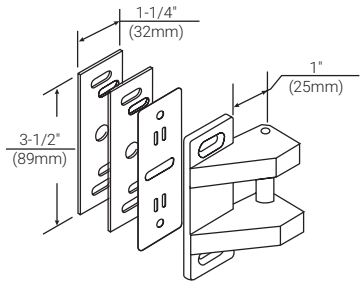
	
<p><b>757F</b> Standard strike for 1800(F) devices. Supplied with #10-24 x 3/4" machine screws, two shims (each 1/16" thick), and one locking plate.</p>	<p><b>793</b> Optional strike for double door applications without a mullion. Supplied with #10-24 x 3/4" machine screws, two shims (each 1/16" thick), and one locking plate.</p>

### Vertical Rod Devices - Top Strikes

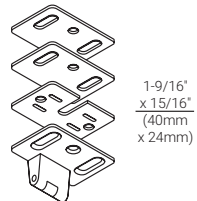
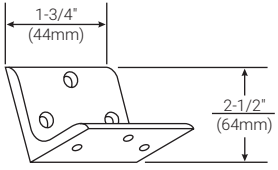
	
<p><b>791</b> Standard top strike for 1810(F) devices. Supplied with #10-24 x 3/4" machine screws, two shims (each 1/16" thick), and one locking plate.</p>	<p><b>797</b> Optional bracket for mounting 791 top strike in flush transom opening. Supplied with 1/4-20 machine screws; SN-134 sex nuts, optional.</p>

### Vertical Rod Devices - Bottom Strikes

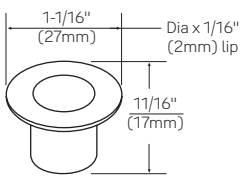
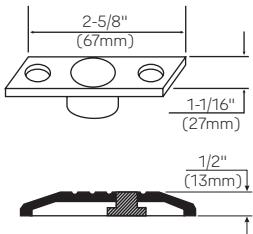
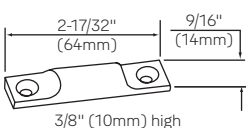
		
<p><b>790</b> Standard bottom strike for 1810(F) series devices. Press in place.</p>	<p><b>794</b> Optional bottom strike for fire openings using saddle thresholds or for flush floor mount. Must use for fire openings with 1/2" thresholds. Supplied with #10-24 x 1/2" machine screws and floor anchors.</p>	<p><b>702</b> Optional bottom strike for bottom pullman latch option. Supplied with #8 x 8/32" combination screws.</p>

## ACCESSORIES

### Shim Kits

Shim kits are available for devices on doors with interfacing molding. Each shim kit contains:

- 2 sets of 1/8" shims (shim up to 1/4")
- Longer fasteners
- Longer connecting bar for the trim
- Installation instructions

223 – Shim Kit for 1800(F) Series rim exit devices

224 – Shim Kit for 1810(F) Series surface vertical rod exit devices

### Extension Rods

1810(F) surface vertical rod devices are supplied standard for 7' (213cm) standard. Rods may be field cut or used with extension rods for other heights. To order, specify:

Model Number	Length
2010-2	2" (51mm)
2010-6	6" (153mm)
2010-12	12" (305mm)

### Specialty Fasteners

#### Sex Nuts:

Required for wood, composite or unreinforced metal doors.

To order specify:

- SN-104 – pack of (4) 10-24 sex nuts for all fire rim exits
- SN-134 – pack of (4) 1/4-20 sex nuts for all devices

#### Wood Door Fasteners:

For solid core wood doors, permitted if pilot holes are used to install screws. Consult the factory for availability.

Torx® Security Screws available for factory product orders.

### Long Tailpiece Kit

Long tailpiece kit for use with escutcheon series trim, up to 3-1/2" thick doors. Specify part number to order.

Door Thickness	Trim Type	Part Number
2" - 2-1/2"	420F Series Trim	81-9500-1665-000
2-1/2" - 3-1/2"	420F Series Trim	81-9500-1635-000

### Bottom Pullman Latch

Optional bottom Pullman latch available for panic-listed vertical rod exit devices. To order with devices, specify "BPL." 702 bottom strike required, see page 17.



## MULLIONS

### M200(F) Removable Mullion

M200(F) steel mullions are for use with 1800(F) Series exit devices. Mullions may be field cut to fit opening. Gray paint finish.

- M200 panic rated.  
Tubular steel, 2" x 3" (51mm x 76mm). Specify 7'2".
- M200F 3 hour fire rated.  
Tubular steel, 2" x 3" (51mm x 76mm). Specify 7'2" or 10'1" (Fire rated up to 8').

**Notes:**

1. For 8' length Mullion must be order as M200F option and cut in the field to 8' size.

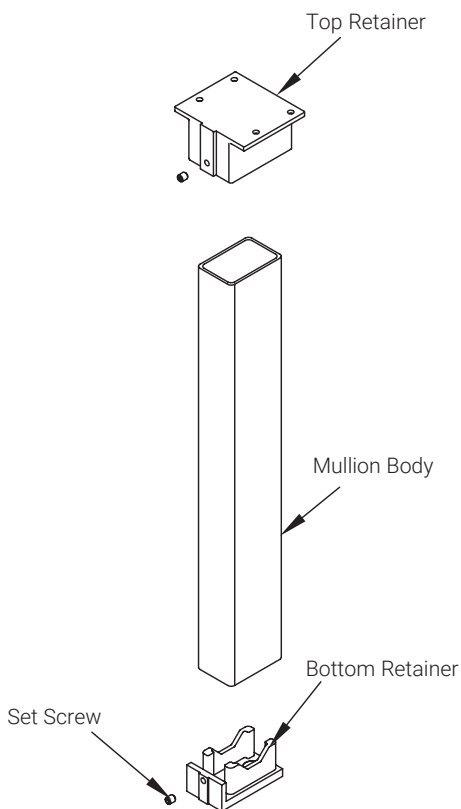

### M200(F) Options

- **M203 Spacer Block**  
Recommended for double rabbeted frames where the stop face width is less than the mounting hole spacing or for applications with 5-3/4" (146mm) or less door frames.

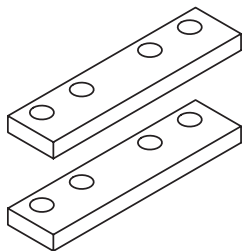

- **M204 Angle Bracket**  
Recommended for any header configuration with less than 3" (76mm) of mounting surface.

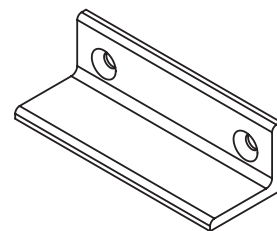

## MULLIONS

### KRM200(F) Keyed Removable Mullion (Krm)

Keyed removable mullions are for use with 1800(F) series exit devices. They are designed for simple removing when an unobstructed large opening is required and easy replacement and locking to maintain the integrity of the opening.

- KRM200 panic rated. Specify 7'2".
- KRM200F 1-1/2 hour fire rated. Specify 7'2" or 10'1" (Fire rated up to 8')

**Notes:**

**1. For 8' length Mullion must be order as KRM200F option and cut in the field to 8' size.**

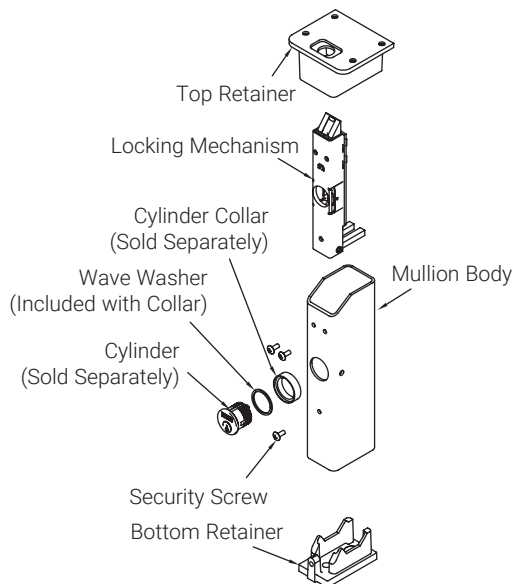

### KRM Features

- Easy cylinder installation.
- Mullion automatically relocks when reinstalled without the use of the cylinder key.
- When ordering, add KR prefix to mullion, example: KRM200 and KRM200F.

### Split Mullion

Hassle-free transportation with a 30% smaller packaging size. Mullions may be field cut to fit opening. Gray painted finish. Available only in 8'. When ordering add suffix SM, example M200SM and KRM200SM

**M200SM Standard**

- Panic rated. Specify 8'
- Tubular steel, 2" x 3" (51mm x 76mm).

**KRM200SM Key Removable Split Mullion**

- Easy cylinder installation.
- Panic rated. Specify 8'
- Tubular steel, 2" x 3" (51mm x 76mm).

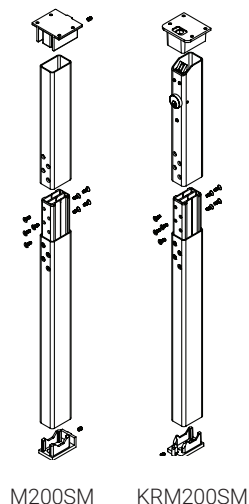

### KRM Options

- **M203 Spacer Block**  
Recommended for double rabbeted frames where the stop face width is less than the mounting hole spacing or for applications with 5-3/4" (146mm) or less door frames.
- **M204 Angle Bracket**  
Recommended for any header configuration with less than 3" (76mm) of mounting surface.

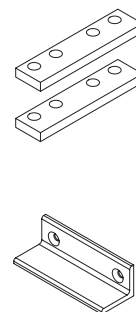

### KRM Collars

Cylinder Model #	Length	Collar Requirement
2153 or 2553	1-1/4"	1765.312
A620 or K660	1-1/4"	1765.406
	1-3/8"	1765.563

## MULLION CYLINDER KIT

Mullion Cylinder Kit	Available with the following mullions series
AMCK1	KRM200
	KRM200F
	KRM200SM

Note: Mullion cylinder kit contains washer, collar and cylinder  
\*Specify finishes and cylinder keyed code when ordering

EX: AMCK1 X FINISH X CYLINDER KEYED CODE  
(i.e. AMCK1 X 630 X CT6)

Keyed Codes	Description
CT6	LFIC Complete, 6 Pin
CT6LL	ASSA ABLOY ACCENTRA® KeyMark® LFIC w/Temp LFIC, 6 Pin
CT6SD	ASSA ABLOY ACCENTRA® KeyMark® SFIC w/Temp Disposable SFIC, 6 Pin
CT6SL	ASSA ABLOY ACCENTRA® KeyMark® SFIC w/Temp Lockable SFIC, 6 Pin
CT7	LFIC Complete, 7 Pin
CT7LL	ASSA ABLOY ACCENTRA® KeyMark® LFIC w/Temp LFIC, 7 Pin
CT7SD	ASSA ABLOY ACCENTRA® KeyMark® SFIC w/Temp Disposable SFIC, 7 Pin
CT7SL	ASSA ABLOY ACCENTRA® KeyMark® SFIC w/Temp Lockable SFIC, 7 Pin
CY	Standard Fixed Core
ICLC	LFIC, Less Core
KM	ASSA ABLOY ACCENTRA® KeyMark® Standard Fixed Core
KMLIC	ASSA ABLOY ACCENTRA® KeyMark® LFIC Complete
KMLICH	ASSA ABLOY ACCENTRA® KeyMark® LFIC Housing Only
KMSIC	ASSA ABLOY ACCENTRA® KeyMark® SFIC Complete
KMSICH	ASSA ABLOY ACCENTRA® KeyMark® SFIC Housing Only
S	Security Fixed Core
SC	Schlage® "C" Keyway Fixed Core
SFIC	Best® Keyways SFIC Complete
SFICLC	Best® Keyway SFIC Housing Only
SIC	Security LFIC Complete

**DIMENSIONS**

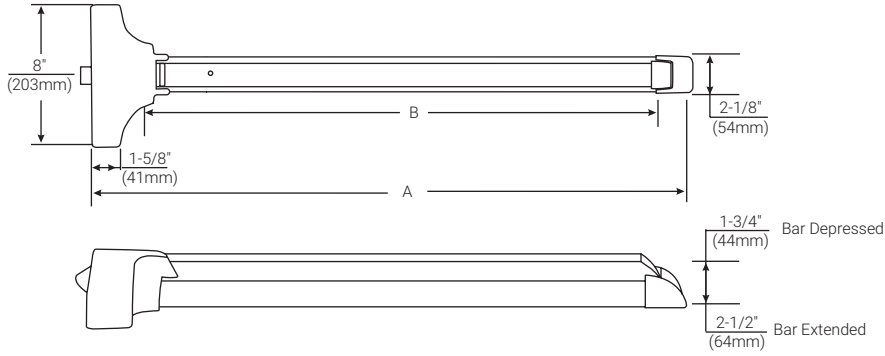

Device Size	"A"	"B"
<b>36"</b>	33" (84cm)	27" (69cm)
<b>42"</b>	39" (99cm)	33" (84cm)
<b>48"</b>	45" (114cm)	39" (99cm)

## TECHNICAL SPECIFICATIONS & LISTINGS

### ANSI/BHMA

Certified ANSI/BHMA A156.3, Grade 1.



### Fire Listings

1800 series exit devices are UL-cUL Listed for use on fire doors having a rating up to and including 3-hours.

Note: Any retrofit or other field modification to a fire rated opening can potentially impact the fire rating of the opening, and ASSA ABLOY ACCENTRA® makes no representations or warranties concerning what such impact may be in any specific situation. When retrofitting any portion of an existing fire rated opening, or specifying and installing a new fire-rated opening, please consult with a code specialist or local code official (Authority Having Jurisdiction) to ensure compliance with all applicable codes and ratings.

### Free Wheeling Lever Trim

1800 series exit device lever trims feature the unique Free Wheeling lever mechanism. This Free Wheeling trim features a clutch mechanism which allows the lever to float down 60° when operated in the locked condition, greatly improving vandal resistance.

### ISO 9001

Designed and manufactured under a certified ISO 9001 quality system.

### Warranty

The 1800 series exit devices carry a three-year warranty. Cylindrical trims (440F) carry a two-year warranty. Escutcheon trims (420F) carry a one-year warranty.

The ASSA ABLOY Group is the global leader in access solutions.  
Every day, we help billions of people experience a more open world.

ASSA ABLOY Opening Solutions leads the development within door openings and products for access solutions in homes, businesses and institutions. Our offering includes doors, frames, door and window hardware, mechanical and smart locks, access control and service.

**ACCENTRA®**

**ASSA ABLOY**

**TECHNICAL SUPPORT**

(troubleshooting, product use and application, returns)

Tel: 855-557-5078

Email: [techsupport.accentra@assaabloy.com](mailto:techsupport.accentra@assaabloy.com)

**CUSTOMER SUPPORT**

(orders, product configuration, pricing, lead-time)

Tel: 855-557-5078 x2

Email: [Customerservice.Accentra@assaabloy.com](mailto:Customerservice.Accentra@assaabloy.com)

**U.S.A.:**

ASSA ABLOY ACCENTRA®

225 Episcopal Road  
Berlin, CT 06037-4004

Tel: 1-800-438-1951

Fax: 1-800-338-0965

[www.accentra-assaabloy.com](http://www.accentra-assaabloy.com)

**Canada:**

ASSA ABLOY Door Security Solutions Canada

160 Four Valley Drive  
Vaughan, Ontario L4K 4T9

Tel: 1-800-461-3007

Fax: 1-800-461-8989

[assaabloydss.ca](http://assaabloydss.ca)

**International:**

ASSA ABLOY Americas International

Tel: 1-905-821-7775

Fax: 1-905-821-1429

[assaabloyai.com](http://assaabloyai.com)