

R8200 Series Simpli™ Roseless Trim

Mortise Lock

WARNINGS & NOTES

All trim components shown will vary by function number Trim one-side functions - refer to instruction sheet A8031

Screw Pack with screws for lockbody, fronts and strike screws (part #77-4236)

Trim both side pack includes inside mounting plate assembly, spindle, through-bolt screws and set screw

Trim one side pack includes inside mounting plate assembly, spindle, through-bolt screws, set screw and trim one side plate

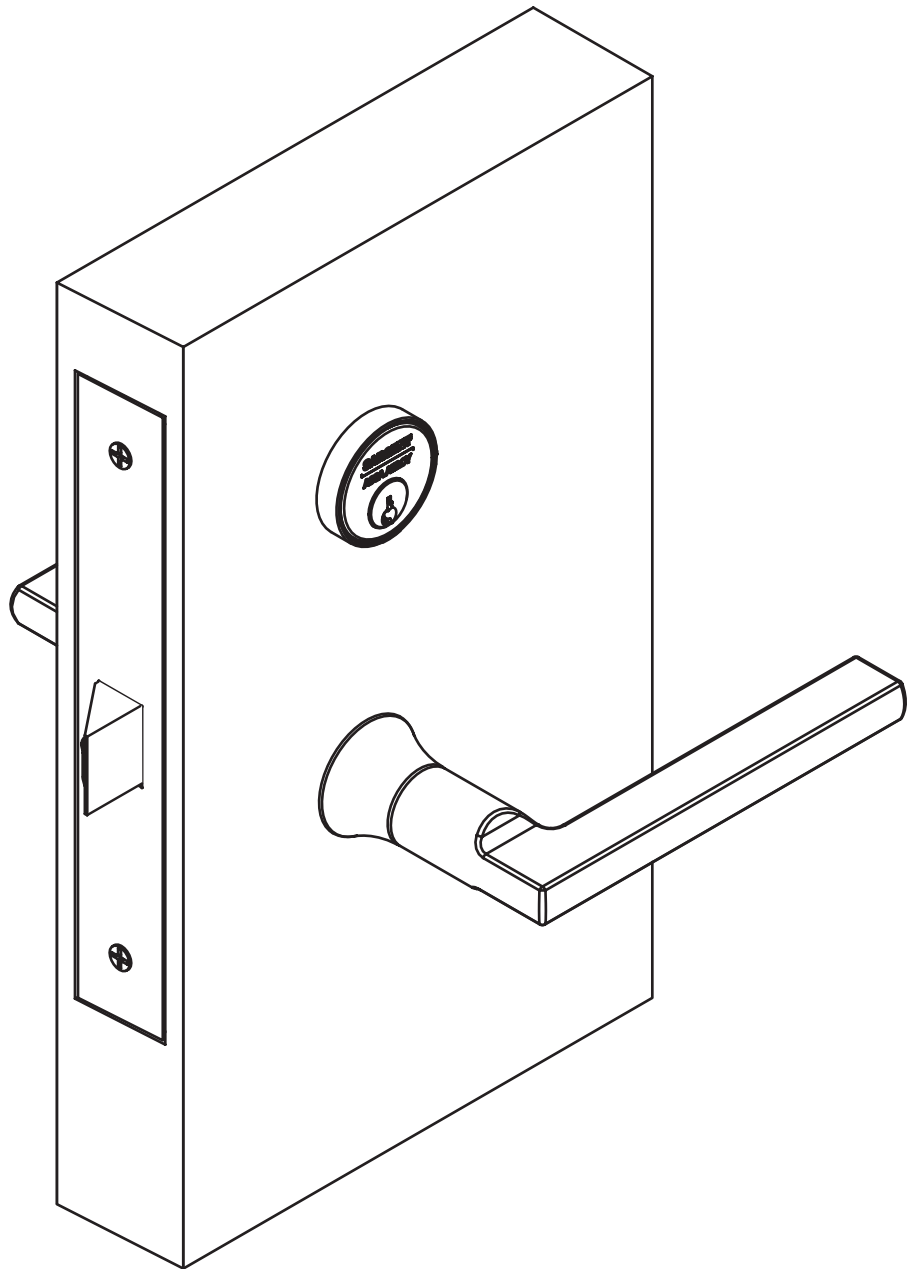

R8200 Series Simpli™ Roseless Trim

Mortise Lock

Installation Instructions

SARGENT

ASSA ABLOY

1 - Parts List

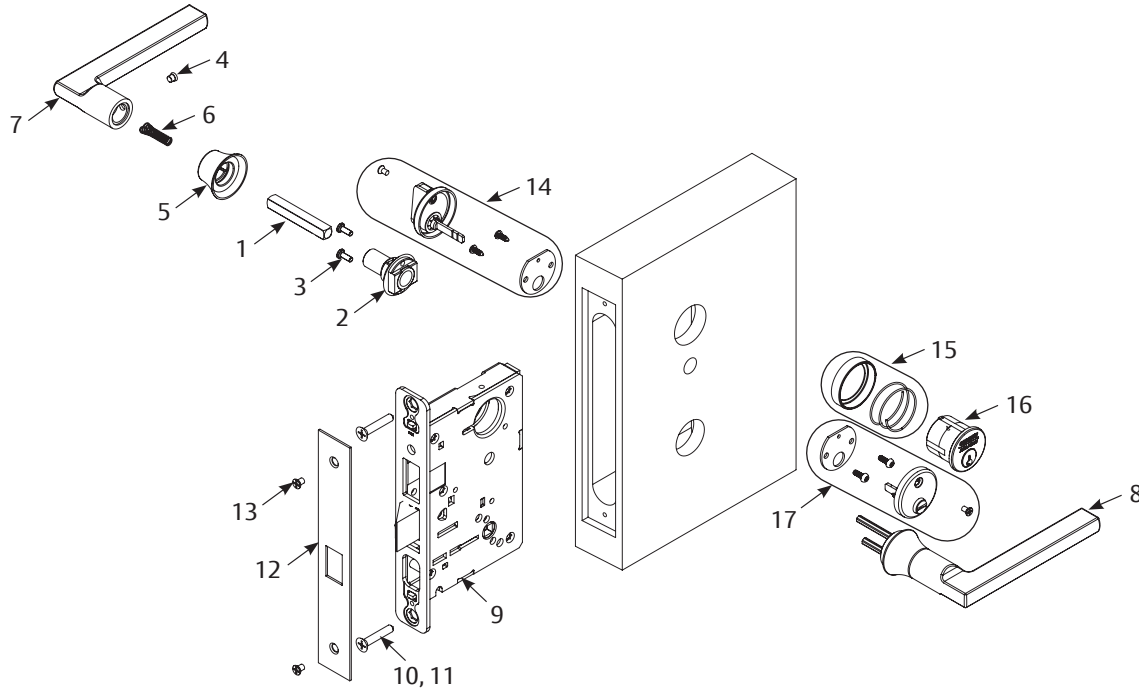

	Part No.	Description	Req.
1	82-0371	Spindle	2
2	82-4675	Mounting plate assembly	1
3	01-9376	#8-32 x 5/8" machine screw with #6 head	2
4	82-1038	Handle screw	1
5	—	Lever base	2
6	82-0347	Spindle spring	2
7	—	Inside lever	1
8	—	Outside lever	1
9	—	Lockbody (various functions)	1
10	01-1019	Machine screw #12-24 x 1/2"	2
11	01-2299	Wood screw #12 x 1-1/4"	2
12	—	Outside front plate, varies by function	1
13	01-1028	Front screw #8-32 x 1/4"	2
14	—	Turn lever pack - 130kb	1
15	—	Cylinder collar/rosette (size varies) 1KB (or larger)	1
16	—	Cylinder (various key systems)	1
17	—	184 x design emergency release assembly	1

Tools Required
• Phillips screwdriver
• T20 Torx
• Lever base tool (provided)

R8200 Series Simpli™ Roseless Trim

Mortise Lock

Installation Instructions

SARGENT

ASSA ABLOY

2 - Install Lockbody, Outside Lever Assembly and Spindle

IMPORTANT:

Check template A4647 to prep door for function holes, size and location. Verify strike location according to template. Clean out door pocket and door edge of any debris. Make sure handing of lock (latch and locking piece) match handing of door.

NOTE: Keep door open during installation.

1. Slide lockbody into door. (Figure 2)
2. Slide outside lever assembly through door and lockbody and hold. (Figure 2)
3. Insert spindle into lockbody hub. (Figure 3)

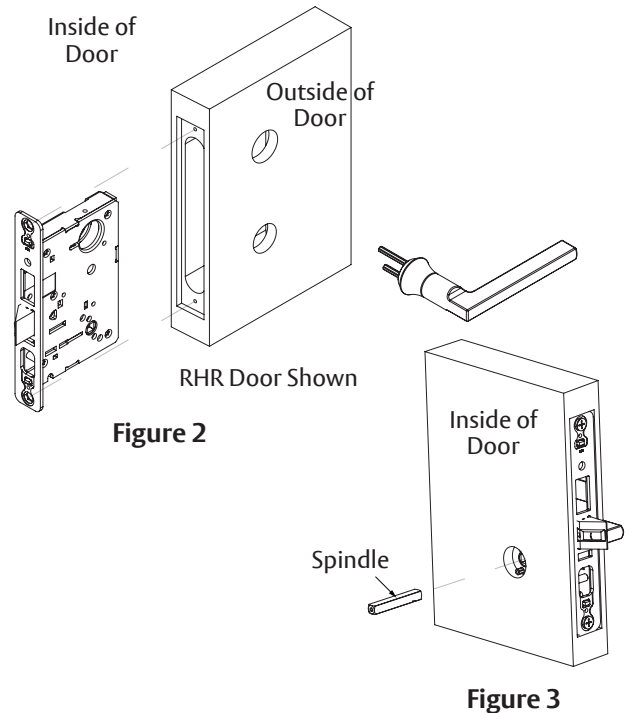

3 - Install Inside Adapter and Cylinder

1. Slide inside adapter over spindle. Verify threaded hole in adapter faces hinge. (Figure 4)
2. Sliding cylinder through spring and collar, thread into lockbody until flush with collar. Verify logo is straight and at top. (Figure 5)
3. Secure cylinder in lockbody using access hole just above deadbolt opening. (Figure 6)

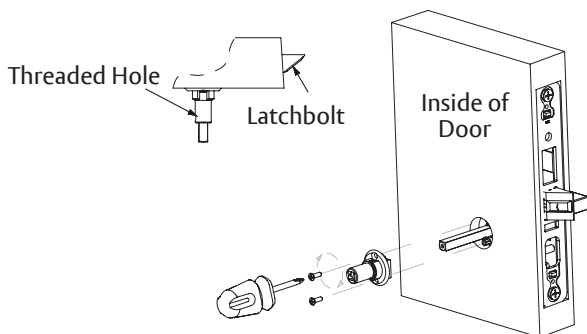

Figure 4

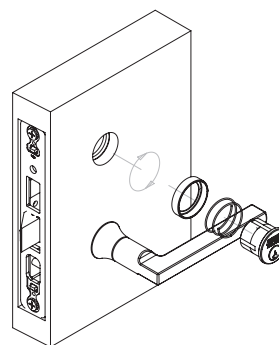

Figure 5

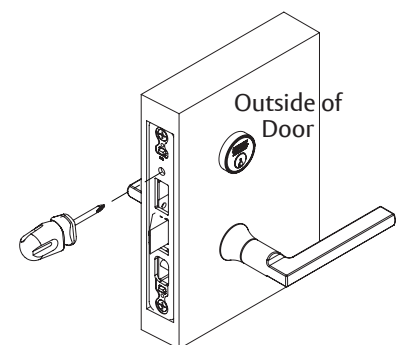

Figure 6

R8200 Series Simpli™ Roseless Trim

Mortise Lock

Installation Instructions

SARGENT®

ASSA ABLOY

4 - Secure Lockbody. Attach Collar. Install Inside Lever.

1. Secure lockbody in door with two (2) wood screws #12 x 1-1/4" or two (2) #12-24 x 1/2" machine screws. (Figure 7)
2. Attach collar to adapter by rotating clockwise using tool supplied. Assemble flush with door. (Figure 7)
3. Slide lever over spindle and adapter. (Figure 8) 4. Secure with set screw. (Figure 9)

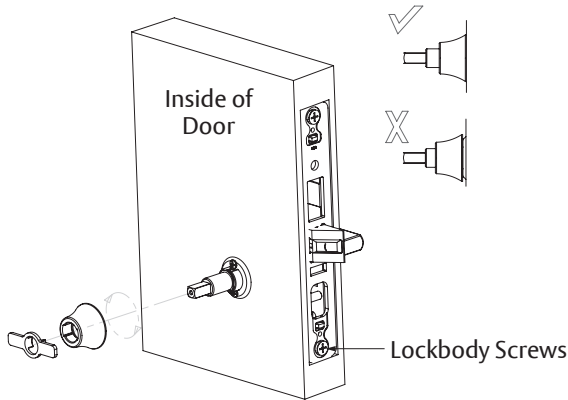

Figure 7

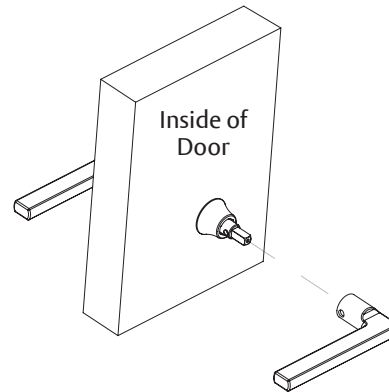

Figure 8

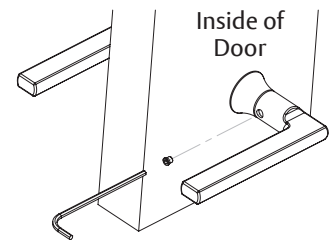

Figure 9

5 - Install Strike Plate and Strike. Test Operation.

1. Attach outside front with two (2) #8-32 x 1/4" flat head screws. (Figure 10)
2. Position and secure strike in frame with screws provided.
3. Test lock function, both levers and cylinder prior to closing door.

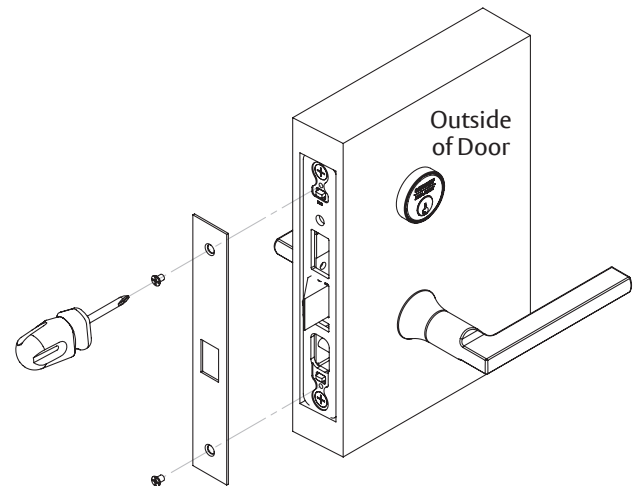

Figure 10

R8200 Series Simpli™ Roseless Trim

Mortise Lock

Installation Instructions

SARGENT

ASSA ABLOY

6 - 8200 Multi-function Options (04, 05, 06, 13, 31, 36, 37, 38)

How to Change Function of Lock:

Green catch screw must be located as designated on lock case to create desired function. (Figure 11)

Three (3) locations:

- 05, 37 and 38 function (15 function in unlocked position)
- 04, 06, 13 and 31 functions
- 36 function

NOTE: When moving green catch screw to 04, 06, 13 and 31 functions, hub position must be at 45° as shown on lock case.

*See How to Change Hand of Lock, page 7.

#41 Cylinder is standard for both single and double cylinder functions for 1-3/4" thick door.

NOTE: Trim one-side functions always require an inside trim assembly which can be used on inside or outside of door.

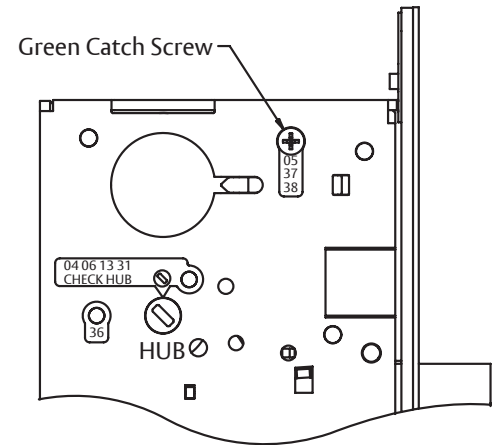

Figure 11

Function	Items Needed To Create Function					
	Outside Lever	Inside Lever	Trim One Side Kit	Outside Cylinder	Inside Cylinder	Thumb Turn
04	X	X		X		
05	X	X		X		X
06		X	X	X		
13		X	X			
15	X	X				
31		X	X	X		
36		X	X	X		
37	X	X		X		
38	X	X		X	X	

R8200 Series Simpli™ Roseless Trim

Mortise Lock

Installation Instructions

SARGENT®

ASSA ABLOY

7 - R8200 Series Function List

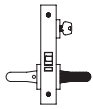

04/F07
Storeroom
closet lock

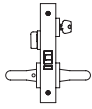

05/F04
Office or
entry lock

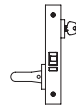

06
Storeroom or
service lock

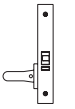

13/F31
Communicating
or exit lock

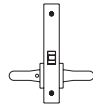

15/F01
Passage or
closet latch

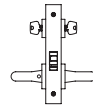

16/F09
Apartment or
exit or public
toilet lock

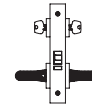

17/F30
Asylum or
institutional lock

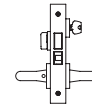

24/F21
Room door
lock

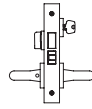

25/F13
Dormitory or
exit lock

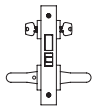

26/F14
Store door
lock

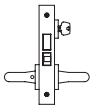

27
Closet or
storeroom lock

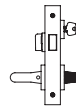

28
Dummy trim
dead lock

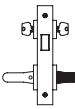

29
Dummy trim
dead lock

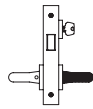

30
Dummy trim
dead lock

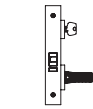

31
Utility
lock

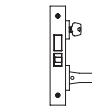

35
Storeroom
lock

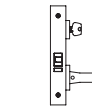

36
Closet
lock

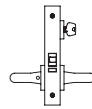

37/F05
Classroom
lock

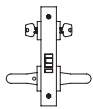

38/F32
Classroom
security intruder
latchbolt lock

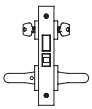

39/F33
Classroom
security intruder
deadbolt lock

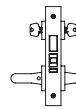

40/41/F34
Classroom
security intruder
deadbolt lock

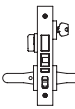

43/F20
Apartment
corridor
door lock

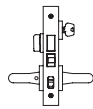

45/F12
Dormitory or
exit lock

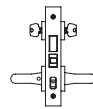

46/F11
Dormitory or
exit lock

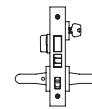

47/F08/F10
Front door lock
or apartment
corridor lock

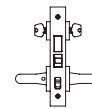

48/F35
Store door
lock

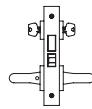

49
Security
deadbolt

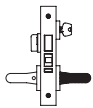

50/51 F15
Hotel guest
lock/Store room
deadbolt lock

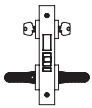

52
Institution
deadbolt lock

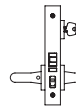

55/F04
Office or
entry lock

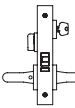

56
Inner entry
lock

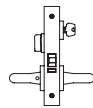

57/58
Institutional
privacy lock

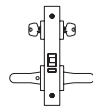

59
Double locking

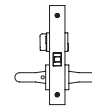

65/F22
Privacy
bedroom
or bath lock

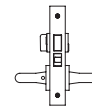

66/F19
Privacy
bedroom
or bath lock

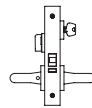

67/F26
Institutional
privacy lock

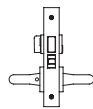

68/F02
Privacy bedroom
or bath lock

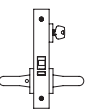

70/71
Electrical
70: Fail safe
71: Fail secure

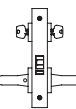

72/73
Electrical
72: Fail safe
73: Fail secure

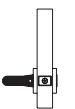

93
Dummy trim

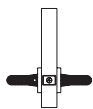

94
Dummy trim

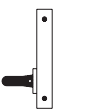

95
Single trim
dummy lock

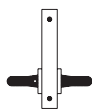

96
Double trim
dummy lock

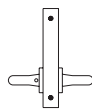

97
Active trim
dummy lock

NOTE: Shaded levers are rigid at all times

1-800-727-5477 • www.sargentlock.com

Copyright © 2010, 2020, 2024, SARGENT Manufacturing Company. All rights reserved. Reproduction in whole or in part without the express written permission of SARGENT Manufacturing Company is prohibited. Patent pending and/or patent www.assaabloydss.com/patents.

A8030 06/24 Rev 5

R8200 Series Simpli™ Roseless Trim

Mortise Lock

Installation Instructions

SARGENT

ASSA ABLOY

8 - How to Change Hand of Lockbody

NOTE: Red surface of locking piece must face secure (keyed/locked) side of door.

To rotate locking piece:

1. Position lockbody with red surface of locking piece visible. (Figure 12)
2. Insert blade type screwdriver into locking piece slot to rotate locking piece.
3. Push locking piece toward back of lockbody and rotate 180° until RED surface shows on opposite side.

IMPORTANT:

04, 06, 13 and 31 functions require:

1. Remove green catch screw.
2. Rotate hub 45° to vertical position.
3. Rotate locking piece for required hand.

NOTE: Red surface faces locked side of door.

4. Rotate hub to original 45° position as shown on lock case.
5. Reinstall green catch screw.

NOTE: Beveled surface of latch must face strike. Deadlatch is self adjusting.

To change hand of latch:

1. Insert flat blade screwdriver into spade shaped slot. (Figure 13)
2. Rotate screwdriver 90° to push latch out until back of latch clears lock front.
3. Rotate latch 180°. Latch will re-enter lockbody. (Figure 14)

NOTE: Latch cannot be unscrewed.

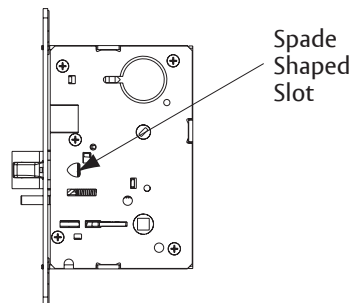
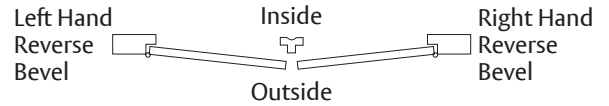
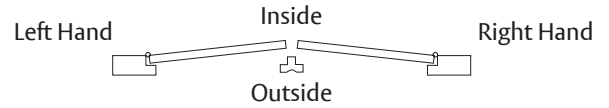

Figure 13

Door Handling



Door hands determined from outside (secured/keyed side)

Figure 12

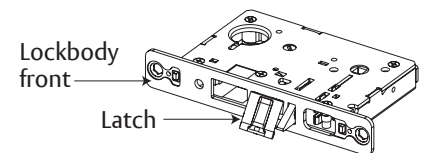
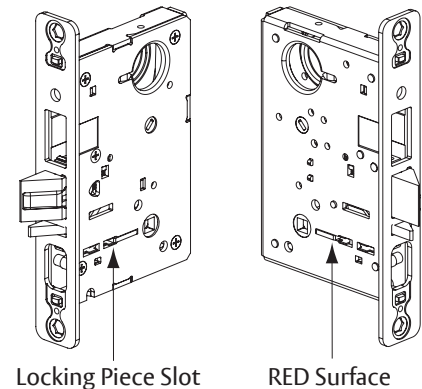

Figure 14

 **WARNING**

This product can expose you to lead which is known to the state of California to cause cancer and birth defects or other reproductive harm. For more information go to www.P65warnings.ca.gov.

 **WARNING**

Attention Installer: Improper installation may result in damage to the product and void the factory warranty.

1-800-727-5477 • www.sargentlock.com

Copyright © 2010, 2020, 2024, SARGENT Manufacturing Company. All rights reserved. Reproduction in whole or in part without the express written permission of SARGENT Manufacturing Company is prohibited. Patent pending and/or patent www.assaabloydss.com/patents.