

**2026 USA
TARIFF PRICE
ADJUSTMENTS**

The 2026 USA Price Book
Tariff Adjustment will remain at
6.25% as previously communicated.

**2026 CANADA TARIFF
PRICE ADJUSTMENTS**

(In addition to prices herein)
Click Here for:

[Canada Tariffs](#)

ASSA ABLOY

Experience a safer
and more open world

GLASS SOLUTIONS

PRICE BOOK

VOLUME 9

USA & CANADA PRICES EFFECTIVE FEBRUARY 2, 2026

PUSH

Table of Contents

Door Rails		Door Controls	
Top & Bottom Rails.....8		Floor Closers.....30-31	
9.5" Patch Rails.....8		Overhead Concealed Closers.....32	
Sub Assemblies.....9		Hydraulic Patch Fitting.....33	
Hardware Prep.....10		Hydraulic Hinges.....33	
		Pivots.....34	
Vertical Stile		Sliding Door Hardware	
Vertical Stiles.....11		Sliding Systems.....35	
Sidelite Glazing Hardware		Door Pulls	
Sidelite Rails.....12-13		Decorative Pulls.....36	
U Channels.....14-15		Standard Pulls.....36	
Headers		Stock Pulls.....37	
2-Piece Headers.....16		Mechanical Locking Hardware	
Solid Headers.....17		Locking Pulls.....38-39	
Floating Headers.....18-19		Center Housing for	
Header Accessories.....20		ASSA ABLOY ACCENTRA™ (formerly	
Thresholds.....20		Yale Commercial) Mortise Locks.....40	
Jamb Tubes		Cylinders.....41	
2-Piece Jamb Tubes.....21		Mortise Locks.....41	
Solid Jamb Tubes.....21		Deadbolt Locks.....42	
Jamb Tube Accessories.....22		Center Housing for	
Patch Fittings		Cylindrical Locks.....42	
For 1/2" and 9/16" Glass.....23-24		Electrified Hardware	
Patch Accessories.....25		Digital Door Lock.....43	
Panic Devices		Mag Locks.....43-44	
Panic Device.....26		Electrified Hardware	
Panic Strikes.....27-28		Accessories.....44	
Dummy Pulls.....28		Readers.....44	
Single Motion Device		Power Supplies.....44	
Single Motion Device.....29		Cladding	
		Rails, Vertical Stiles,	
		U-Channels, Headers.....45	
		End Caps	
		Rails, Vertical Stiles, Headers.....46	





The Beauty of Glass

As the industry leader in door security, innovation, and design, ASSA ABLOY offers a complete line of commercial hardware solutions for glass door applications including: patch fittings, door rails, architectural pulls, mechanical and electrified locking products. Our Glass Solutions program allows the convenience of placing a single order and dedicated technical and customer service experts.

Glass Solutions Program Information

The ASSA ABLOY Glass Solutions program allows the convenience of placing a single order from multiple ASSA ABLOY brands.

Customer Service/Technical Product Support

For Glass Solutions questions please contact us via phone or email. Customer Service: 855-594-6989, CustomerService.GlassSolutions@assaabloy.com
Technical Product Service: 855-594-6989, TechSupport.GlassSolutions@assaabloy.com

Quotes

Quote requests can be emailed to: Quotes.GlassSolutions@assaabloy.com

Orders

Orders can be submitted online, emailed, or faxed to:
Online: <http://extranet.assaabloydss.com/> and select Order Entry under the Customer Service Menu
Email: Orders.GlassSolutions@assaabloy.com
Fax: 844-851-8665

For Canada:
Online: <http://extranet.assaabloydss.ca/> and select Order Entry under the Customer Service Menu
Email: orders.dss.ca@assaabloy.com
Phone: 800-461-3007
Fax: 800-461-8989

Mixed Orders

For your convenience your Glass Solutions order can be combined with other Rockwood products. If your order contains items that are not included in either the Glass Solutions or Rockwood product line it will be omitted from your order and not shown on the acknowledgement.

Prices

This price list cancels and supersedes all prior listings. Surcharges may be necessary due to a change in laws, including but not limited to, tariffs, duties, and surtaxes. Any price change, if applicable, are in addition to any regularly announced price adjustments and are subject to implementation without advance notice.

We reserve the right to decline portions or the entirety of an order. All accepted products will be shown on the order acknowledgement with the current pricing. Pricing is subject to change without notice.

Terms and Conditions of Sale

Terms: 1% 15 days, net 30 days
Remit Payment To: PNC Bank/Rockwood, PO Box 644489, Pittsburgh, PA 15264-4489

Part Numbers

Our part numbers were designed to facilitate ease of ordering and ensure all products are tied to the coordinating job. Each part number specifies the product family, glass thickness (if applicable) and finish.



ASSA ABLOY
Opening Solutions

Experience a safer
and more open world

USA & Canada Prices Effective February 2, 2026 | Click Here for: [Canadian Tariffs](#)
The 2026 Price Book Tariff Adjustment will remain at 6.25% as previously communicated.
USA: 855 594 6989 • www.assaabloyglass.us | Canada: 800 461 3007 • www.assaabloydss.ca

Copyright © 2021-2026, ASSA ABLOY Accessories and Door Controls Group, Inc. All rights reserved. Reproduction in whole or in part without the express written permission of ASSA ABLOY Accessories and Door Controls Group, Inc. is prohibited.

Glass Thickness Codes

Part numbers include a letter which identifies glass thickness or range of thickness compatible with that item. For example part numbers containing "AC" can be used on glass thicknesses ranging from $\frac{3}{8}$ " to $\frac{9}{16}$ ".

Glass Thickness	Size Code	Finishes Codes*		
		US	ANSI/BHMA	Description
$\frac{3}{8}$ "	A	28	628	Clear Anodized Aluminum
$\frac{1}{2}$ "	B	314	N/A	Extra Dark Anodized Aluminum
$\frac{9}{16}$ "	C	(314E)	N/A	Extra Dark Anodized Equivalent
$\frac{5}{8}$ "	D	32D	630	Satin Stainless Steel
$\frac{11}{16}$ "	E	32	629	Bright Stainless Steel
$\frac{3}{4}$ "	F	BSP	N/A	Black Suede Powder Coat
$\frac{13}{16}$ "	G	WSP	N/A	White Suede Powder Coat
		4E	N/A	Translucent Brass Powder Coat

*Special finishes considered upon request.

Stock Powder Coats Available

OptiCoat™ Finish Codes	
Description	Rockwood Code
Somerset Pine	SPS
Casselman Pine	CPS
Scarlett Oak	SOS
Tangerine Oak	TOS
Amber Oak	AOS
Blonde Oak	BOS
Espresso Walnut	EWS
Toasted Walnut	TWS
Auburn Cherry	ACS
Burnt Sienna Cherry	BCS
Maple Cherry	MCS
Sunrise Cherry	SCS
White Marble	WMS

Available on select product categories.

Max length for OptiCoat™ is 140".

Door Rail Deducts		
Rail	Deduct	Bite
2 $\frac{3}{4}$ " Sq	2"	$\frac{3}{4}$ "
2 $\frac{3}{4}$ " Tp	1 $\frac{15}{16}$ "	$\frac{13}{16}$ "
4"	3 $\frac{1}{8}$ "	$\frac{7}{8}$ "
6"	4 $\frac{5}{16}$ "	1 $\frac{11}{16}$ "
10"	8 $\frac{5}{16}$ "	1 $\frac{11}{16}$ "

Door Handing and Swing

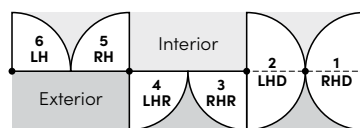

TERMS AND CONDITIONS

Freight Policy

Freight Terms Continental US: All orders are F.O.B. factory via the most economical routing. Purchaser assumes the risk of loss or damage in transit.

- Standard Freight: For NET orders of \$2,000 or more, freight will be prepaid.
- Long Length Freight: All shipments that exceed 96" in packaged length must be shipped LTL. A surcharge fee of \$150 will be applied to all Net orders below \$3,000.
 - Add 4" to the length of the product for finish package length.
- Extreme Length Freight: All shipments between 144" – 216" in packaged length must be shipped LTL. A surcharge fee of \$400 will be applied to all orders.

Freight Terms Alaska & Hawaii: All orders are F.O.B. factory via the most economical routing. Purchaser assumes the risk of loss or damage in transit.

- Standard Freight: For NET orders of \$2,750 or more, freight will be prepaid.
- Long Length Freight: All shipments that exceed 96" in packaged length must be shipped LTL. A surcharge fee of \$250 will be applied to all Net orders below \$3,750.
 - Add 4" to the length of the product for finish package length.
- Extreme Length & Bulky Freight: Actual Freight will be charged. Please contact factory for a freight estimate.

Special Order Material

Items made to your specifications (not stock items) are not returnable. These items are not subject to cancellation without consideration of expense involved at the cancellation date.

Returned Goods

Return no merchandise without written permission from the factory. Authorization will insure proper credit. Errors in shipping may occasionally occur. If this is the case immediately notify the factory, and we will gladly make the proper adjustments. If the error is at the customers end, a minimum charge of 25% plus freight will be incurred. Unauthorized claims for labor or charges will not be allowed. No credit will be allowed beyond six months after invoice date.

Claims

Inspect before you sign! If there is a shortage or damage, accept the shipment only after freight agent makes a damage or shortage notation on your freight bill, bill of lading, or delivery receipt. If damage or loss is evident notify your freight agent and request inspection with 10 days of receipt of goods. Claims must be made within 30 days of shipment and are subject to approval. Claims made after 30 days are not honored. Responsibility for damage, visible, or concealed, ceases upon delivery to the transportation company.

Shortages

Claims for shortages must be made within 30 days of the invoice date.

Samples

Saleable samples will be charged at regular prices.

Templates

Commonly used templates are available on our website at www.assaabloyglass.us

WARRANTY - ASSA ABLOY Rockwood & Glass Solutions Products

ASSA ABLOY (in Rockwood, PA) warrants that its products sold under the ASSA ABLOY trade name in the United States of America are free from defects in workmanship and materials under normal use and service. This warranty does not cover defects or damage arising from improper installation, lack of or improper maintenance, improper storage, corrosion, erosion, ordinary wear and tear, misuse, abuse, accident, unauthorized service, other causes beyond ASSA ABLOY's control, or use with unauthorized non-ASSA ABLOY products or parts.

The following instances void warranty:

- Expose to air pollutants including, but not limited to acid rain, chemicals, salt, or fumes.
- Failure or settling of the structure/building/ foundation.
- Repairing or re-finishing the hardware without consensus of the manufacturer.
- Any modification or disassembling of the warranty product, regardless of whether the modification causes or contributes to the alleged defect.

The only liability of ASSA ABLOY (in Rockwood, PA) in tort or contract whether under this warranty or otherwise, shall be limited to the repair, replacement, or refund of the original purchase price of the product or component that is alleged to be defective at ASSA ABLOY's discretion. The warranty period starts at the delivery date to the original purchaser and extends by the duration listed below. Any repair or replacement of a component does not extend the warranty period past the original period.

Items cross listed in ASSA ABLOY Glass Solutions fall under the original manufacturing company's warranty. Items listed solely in the Glass Solutions product offering have a two year limited warranty. The PDU8000 series features a three year limited warranty.

Purchaser should contact ASSA ABLOY (in Rockwood, PA) upon receipt of any product claimed to be defective. If an in-plant inspection is necessary, purchasers should obtain a Return Goods Authorization and then send the product freight paid to ASSA ABLOY (in Rockwood, PA.) If, upon inspection, the product is determined by ASSA ABLOY (in Rockwood, PA) to be defective within the guidelines of this warranty, ASSA ABLOY (Rockwood, PA) will promptly repair or replace the defective product.

In the event of an acceptance of Purchaser's Purchase Order by ASSA ABLOY (in Rockwood, PA), the Purchaser agrees that such acceptance is solely conditioned on Purchaser's acceptance of the terms and conditions set forth in this instrument, regardless of the terms and conditions specified in Purchaser's Purchase Order. The terms and conditions in Purchaser's Purchase Order which conflict with the terms and conditions of this instrument shall be disregarded and are hereby rejected, and this instrument shall constitute the entire agreement between ASSA ABLOY and the Purchaser.

THIS WARRANTY IS IN LIEU OF ALL OTHER EXPRESS WARRANTIES. TO THE EXTENT PERMITTED BY LAW, ALL IMPLIED WARRANTIES ARE LIMITED TO THE DURATION OF THIS WARRANTY. ASSA ABLOY (IN ROCKWOOD, PA) SHALL NOT BE LIABLE FOR ANY INCIDENTAL OR CONSEQUENTIAL DAMAGES. NO AGENT, SALES REPRESENTATIVE OR DEALER HAS THE AUTHORITY TO INCREASE OR ALTER THE OBLIGATIONS OF THIS WARRANTY.

Export Control and Sanctions

- 1.1 The Customer represents and warrants to ASSA ABLOY Glass Solutions that it will always act in compliance with Economic Sanctions and Export Control Laws, and that:
 - a) neither the Customer, its affiliates, or any of their respective directors, officers, employees nor, so far as the Customer is aware, any agents or other persons acting on behalf of any of the foregoing:
 - I. is, or has been, a Listed Person;
 - II. has engaged in any business dealings or activities that would reasonably be expected to result in it becoming a Listed Person;
 - III. directly or indirectly, has conducted or is conducting any business dealings or activities with or for the benefit of, or is otherwise involved in any business with a Listed Person, or otherwise acting in violation of Economic Sanctions and Export Control Laws;
 - IV. has engaged or is engaging in any transaction that circumvents, evades or avoids, or has the purpose or effect of circumventing, evading or avoiding, or attempts to violate, any Economic Sanctions and Export Control Laws; or
 - V. is, or has been, in violation of, or subject to, any investigation or enquiry by, or on behalf of, any governmental or other regulatory body relating to Economic Sanctions and Export Control Laws.
 - b) the Customer shall act in compliance with Economic Sanctions and Export Control Laws, and shall not sell nor re-export the Product without all requisite licenses and approvals under Economic Sanctions and Export Control Laws;
 - c) the Customer shall not sell, export or re-export, the Product, directly or indirectly, to the Russian Federation or Belarus or for use in the Russian Federation or Belarus (whether or not permitted under Economic Sanctions and Export Control Laws applicable to the Customer);

ASSA ABLOY

Experience a safer
and more open world

USA & Canada Prices Effective February 2, 2026 | Click Here for: [Canadian Tariffs](#)
The 2026 USA Price Book Tariff Adjustment will remain at 6.25% as previously communicated.
USA: 855 594 6989 • www.assaabloyglass.us | Canada: 800 461 3007 • www.assaabloydss.ca

Copyright © 2021-2026, ASSA ABLOY Accessories and Door Controls Group, Inc. All rights reserved. Reproduction in whole or in part without the express written permission of ASSA ABLOY Accessories and Door Controls Group, Inc. is prohibited.

- d) the Customer shall undertake its best efforts to ensure that the purpose of this Clause is not frustrated by any third parties further down the commercial chain, including by possible resellers;
 - e) the Customer agrees to (i) cascade the contractual obligations set forth in this Section 1.1 in contracts with third parties, including possible resellers, further down the commercial chain.; and (ii) set up and maintain an adequate monitoring mechanism to detect conduct by any third parties further down the commercial chain, including by possible resellers, that would frustrate the purpose of this Section 1.1;
 - f) the representations and warranties set forth in this Section 1.1 above shall always remain true and correct;
 - g) the Customer will provide written notice to ASSA ABLOY Glass Solutions as promptly as possible and in any event within five business days, if (i) any representation or warranty should cease to be true at any time., or (ii) the Customer should encounter any problems in applying paragraphs b)- e) in this Section 1.1 above, including any relevant activities by third parties that could frustrate the purpose of said paragraphs b)- e); and
 - h) the Customer will not engage in any transaction for Military End-Use unless explicitly approved in writing by ASSA ABLOY Glass Solutions.
 - i) The Customer will provide all information relating to requests for Products that the Customer suspects could violate or circumvent Economic Sanctions and Export Control Laws, including requests from or on behalf of a Listed Person, and other attempts to acquire ASSA ABLOY Glass Solutions products in violation of Economic Sanctions and Export Control Laws. The Customer will, to the best of its abilities, cooperate with ASSA ABLOY Glass Solutions to facilitate compliance with Economic Sanctions and Export Control Laws and will upon ASSA ABLOY Glass Solutions's request provide ASSA ABLOY Glass Solutions with true, complete and correct copies of all documentation relating to any business dealings involving the Product, including but not limited to, end-user certifications, information concerning compliance with the obligations under above paragraphs b)- e) in this Section 1.1, and other information as may be required by ASSA ABLOY Glass Solutions within two weeks of the simple request of such information.
- 1.2 ASSA ABLOY Glass Solutions shall not be obliged to make any payment or take any other action if ASSA ABLOY Glass Solutions believes in good faith that such action may constitute a violation, contribute to a violation, or constitute a circumvention of any Economic Sanctions and Export Control Laws.
- 1.3 This agreement may be terminated immediately by ASSA ABLOY Glass Solutions by written notice to the Customer if:
- (a) the Customer fails to provide any notice required under this Section 1.1 above, or should ASSA ABLOY Glass Solutions determine, in its sole discretion, that any representation or warranty set forth in Section 1.1 above has failed to be true and correct at any time;
 - (b) the Customer has misrepresented or failed to properly disclose any material fact, or to provide any documentation, certifications or information requested by Glass Solutions; or,
 - (c) either party's ability to fulfil an obligation under this agreement is materially affected by the imposition of restrictions in Economic Sanctions and Export Control Laws.
- 1.4 Upon any such termination, this agreement and all rights and obligations hereunder shall immediately terminate, provided that the Customer shall remain liable to ASSA ABLOY Glass Solutions for any breach of its obligations hereunder.
- 1.5 The Customer shall indemnify ASSA ABLOY Glass Solutions and its affiliates, directors, officers, employees, advisors, agents and holders of its equity interests (collectively, "Indemnitees") against, and shall hold each Indemnitee harmless from, any and all third party claims, damages and liabilities, including the reasonable fees, charges and disbursements of counsel, incurred by or asserted against any Indemnitee arising out of, in connection with, or as a result of (a) any representation or warranty set forth in Section 1.1 above not being true and correct when made, (b) any breach by the Supplier of any obligation under Section 1.1 or 1.2 above, or (c) any claim, litigation, investigation or proceeding relating to any of the foregoing, whether based on contract, tort or any other theory. This indemnity shall survive the termination of this agreement indefinitely.
- For the purposes of this part of the agreement under the heading "Export Control and Sanctions",
- "Economic Sanctions and Export Control Laws"** means all economic sanctions and export control laws, regulations, rules or restrictive measures, including but not limited to import and export restrictions on materials, intellectual property, other intangible personal property, services, items and transactions, adopted and enforced by governmental authorities of Canada, the EU, UK, UN, USA or any other relevant governmental or regulatory authority, applicable to the ASSA ABLOY Glass Solutions or the Customer.
- "Listed Person"** means individuals and entities listed, or parties that are determined to be owned or controlled by one or more individuals or entities listed, in Economic Sanctions and Export Control Laws.
- Compliance with Anti-Trust, Anti-Corruption and Data Privacy Laws:
- The Customer, its directors, officers, and employees shall perform their obligations under these Terms and Conditions in full compliance with the ASSA ABLOY Code of Conduct which is accessible online at: [Our Code of Conduct for business partners | ASSA ABLOY](#).
- [Click this Link to Export Control and Sanctions for Canada.](#)

Door Rails



Door Rail (24" to 36")*

Includes Blocking Only. Specify Sub Assembly on pg. 7.

Part # (Add Finish)	Profile	Height	Glass Sizes	Finish						
				32D/630	32/629	28/628	314	314E/BSP/WSP	4E	OptiCoat™
DRS-275AC	Square	2 3/4"	A - C	484.00	566.00	421.00	449.00	497.00	524.00	622.00
DRS-4AC	Square	4"	A - C	383.00	448.00	252.00	270.00	296.00	414.00	370.00
▲DRT-4AC	Tapered	4"	A - C	383.00	448.00	252.00	270.00	296.00	414.00	370.00
DRS-6AC	Square	6"	A - C	538.00	625.00	564.00	601.00	667.00	582.00	833.00
DRS-10AC	Square	10"	A - C	936.00	1,086.00	847.00	898.00	954.00	1,015.00	1,192.00
DRT-275BD	Tapered	2 3/4"	B - D	549.00	629.00	483.00	509.00	568.00	702.00	878.00
DRS-4DG	Square	4"	D - G	409.00	469.00	291.00	308.00	346.00	442.00	552.00
DRT-4DG	Tapered	4"	D - G	409.00	469.00	291.00	308.00	346.00	442.00	552.00
DRS-6DG	Square	6"	D - G	617.00	719.00	649.00	692.00	766.00	670.00	837.00
DRS-10DG	Square	10"	D - G	1,077.00	1,250.00	972.00	1,033.00	1,097.00	1,168.00	1,460.00
9.5" Patch Rail										
DRS-4PR	Square	4"	B - C	358.00	355.00	317.00	306.00	321.00	389.00	487.00
DRT-4PR	Tapered	4"	B - C	358.00	355.00	317.00	306.00	321.00	389.00	487.00

*Add \$80 list to any door rail over 36".

Order form available. Order Example: Need: 4" square door rail with 300# End Load Bottom Pivot.

Order: DRS-4AC, 32D, 35.75" 1/2" Glass thickness and PV-300ENDLOAD.

Acknowledgement reads: **DRS-4AC-B P300 32D 0.5 35.75**.

Ordering 2 lines - will show as 1 in your acknowledgement.

[†]Part of the ThermaGuard™ NFRC System.

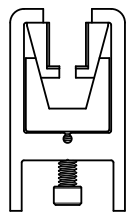

Square 2 3/4"
(DRS-275)

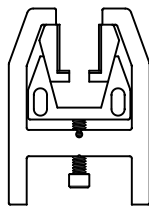

Tapered 2 3/4"
(DRT-275)

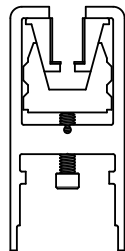

Square 4"
(DRS-4)

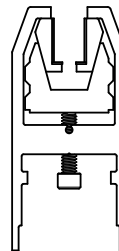

Tapered 4"
(DRT-4)

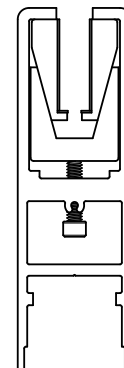

Square 6"
(DRS-6)

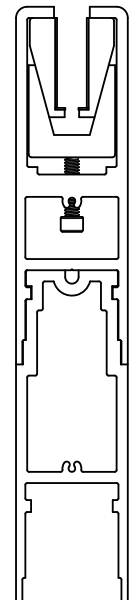

Square 10"
(DRS-10)

ASSA ABLOY

Experience a safer
and more open world

USA & Canada Prices Effective February 2, 2026 | Click Here for: [Canadian Tariffs](#)

The 2026 USA Price Book Tariff Adjustment will remain at 6.25% as previously communicated.

USA: 855 594 6989 • www.assaabloyglass.us | Canada: 800 461 3007 • www.assaabloydss.ca

Copyright © 2021-2026, ASSA ABLOY Accessories and Door Controls Group, Inc. All rights reserved. Reproduction in whole or in part without the express written permission of ASSA ABLOY Accessories and Door Controls Group, Inc. is prohibited.

Door Rail Sub Assemblies				Finish							†Additional Prep	
Part # (Add Finish)	Top (T) or Bottom (B)	Ack Code	Description	32D/ 630	32/ 629	28/ 628	314	314E BSP WSP	4E	OptiCoat™	32D/630 32/629 4E	28/628 314/PC OptiCoat™
OHC-609-ARM	T	A	End Load Overhead Closer Arm Compatible w/OHC-609 & OHC-304	57.00				Mill Finish			Included	
DOHC-275**	T	A	Arm for 2 3/4" & DRT-4PF/DRS-4PF	57.00				Mill Finish			Included	
PV-WALKBEAM**	T	P	Walking Beam Pivot	71.00	81.00	71.00	81.00	89.00	98.00	111.00	Included	
PV-ENDLOAD**	B	P	Adjustable End Load Bottom Pivot	70.00				Satin AL Finish			Included	
PV-300ENDLOAD	B	P300	300 lb. End Load Bottom Pivot	113.00				130.00	143.00	163.00	Included	
FC-6275/ 6280-ARM	B	A	Centerhung Arm for 6275 & 6280	56.00							Included	
FC-6275/ 6280-OFFARM	B	OFFSET	3/4" Offset Arm for 6275 & 6280	92.00			Mill Finish	198.00	208.00	248.00	100.00	75.00
FC-28ARM	B	28A	Standard Arm for Rixson 28 Closer	208.00				Mill Finish			100.00	85.00
FC-28-554ARM	B	554A	554 Arm for Rixson 28 Closer	208.00				Mill Finish			50.00	50.00
PV-340	T	340P	Rixson Walking Beam Pivot	218.00 (26D)		252.00 (26)		251.00	275.00	313.00	50.00	50.00
PV-H340	T	H340P	Heavy Duty Walking Beam Pivot	711.00 (26D)				745.00	817.00	930.00	50.00	50.00
PV-EH340	T	EH340	Electrified Walking Beam Pivot	1,242.00 (26D)				1,304.00	1,434.00	1,527.00	50.00	50.00
PV-345	T	345P	Extended Pin Walking Beam Pivot	711.00 (26D)				745.00	817.00	930.00	50.00	50.00
PV-H345	T	H345P	Heavy Duty Extended Pin Walking Beam Pivot	1,230.00 (26D)				1,273.00	1,402.00	1,592.00	50.00	50.00
PV-180**	T	180P	Rixson Offset Top Pivot	333.00 (26D)				366.00	403.00	457.00	100.00	75.00
DR-BTMLOCK**	B	L	Bottom Door Rail Lock	46.00							*60.00	*50.00
DR-LOCKCYL**	B	CYL	1" Cylinder w/Collar	28.90	28.90	28.90	28.90	48.00	53.00	60.00	No Prep	
DR-LOCKTT**	B	TT	1" Thumbturn w/Collar	28.90	28.90	28.90	28.90	48.00	53.00	60.00	No Prep	
DR-LOCK-IND***	B	IND	Lock Indicator	31.60	31.60			51.00	56.00	64.00	No Prep	

For replacement parts, order Door Rail Sub Assembly and finish.

†Additional Rail Prep is required for some Sub Assemblies.

*For additional rail prep for 2 3/4" rails, see Rail Hardware Prep table on page 8.

** Notes hardware preps that are compatible with the 9.5" Patch Rail.

*** Indicator is not available on DRT-275 rail.

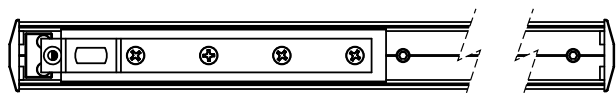

Floor Closer Arm (FC-6275/6280-ARM)



Adjustable End Load Bottom Pivot (PV-ENDLOAD)

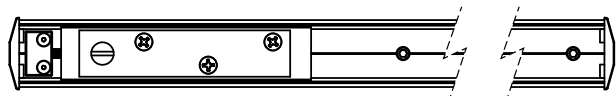

Walking Beam Pivot (PV-WALKBEAM)

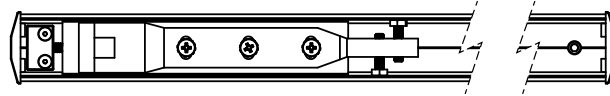

End Load Overhead Closer (OHC-609-ARM)

2 3/4" Rail Compatible Parts

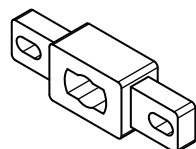

Floor Closer/Pivot Insert (DRC-275)

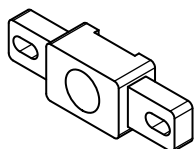

Top Pivot Insert (DRP-275)

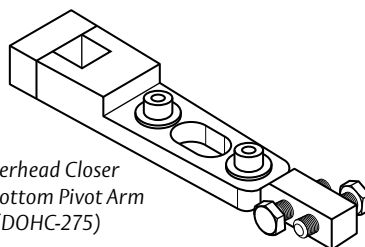

Overhead Closer and Bottom Pivot Arm (DOHC-275)

USA & Canada Prices Effective February 2, 2026 | Click Here for: [Canadian Tariffs](#)
 The 2026 USA Price Book Tariff Adjustment will remain at 6.25% as previously communicated.
 USA: 855 594 6989 • www.assaabloyglass.us | Canada: 800 461 3007 • www.assaabloydss.ca

Copyright © 2021-2026, ASSA ABLOY Accessories and Door Controls Group, Inc. All rights reserved. Reproduction in whole or in part without the express written permission of ASSA ABLOY Accessories and Door Controls Group, Inc. is prohibited.

ASSA ABLOY

Experience a safer
and more open world

Door Rails (cont')

Door Rail Accessory		Finish			
		26D/626	26/625	314E/BSP/WSP	OptiCoat™
Part # (Add Finish)	Description				
*570	Dust Proof Strike	23.20	29.70	48.40	60.00

*Use Accessories Price Book multiplier for prices on this product.

Rail Hardware Prep (Price Per Rail)	32D/630 32/629 4E	28/628 314/PC OptiCoat™
Offset Pivot Prep	100.00	75.00
Panic/Single Motion Prep	75.00	75.00
Competitor Panic Prep	150.00	150.00
Panic/Single Motion Prep (2 3/4" Rail)	125.00	125.00
SAM Mag Prep	100.00	100.00
Competitor Mag Prep	175.00	175.00
Bottom Lock Prep & Install	60.00	50.00
Bottom Lock Prep & Install (2 3/4" Rail)	110.00	100.00
†Pull Prep	50.00	35.00
Rixson Alignment Hole Prep	50.00	35.00
Weather Strip Installed (Not compatible with 2 3/4" Rails)	125.00	125.00
Concealed Auto Operator Prep	175.00	160.00
Exposed Arm Closer Prep	175.00	160.00
Overhead Stop/Holder Prep	175.00	160.00
Other ASSA ABLOY Closer/Pivot Prep	50.00	50.00
Competitor Closer/Pivot Prep	100.00	100.00
*Door Contact Prep	75.00	75.00

†For DDU8000 use Pull Prep price.

*Standard Door Contact Prep is for Securitron DPS-M.

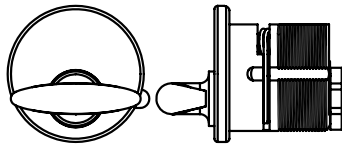

1" Thumbturn
(DR-LOCKTT)

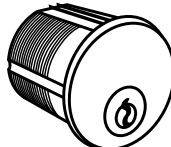

1" Cylinder
(DR-LOCKCYL)

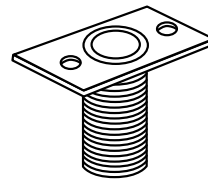

Dust Proof Strike
(570)

ASSA ABLOY

Experience a safer
and more open world

USA & Canada Prices Effective February 2, 2026 | Click Here for: [Canadian Tariffs](#)
The 2026 USA Price Book Tariff Adjustment will remain at 6.25% as previously communicated.
USA: 855 594 6989 • www.assaabloyglass.us | Canada: 800 461 3007 • www.assaabloydss.ca

Copyright © 2021-2026, ASSA ABLOY Accessories and Door Controls Group, Inc. All rights reserved. Reproduction in whole or in part without the express written permission of ASSA ABLOY Accessories and Door Controls Group, Inc. is prohibited.

Vertical Stiles



Vertical Stiles (Sold in sets)					Finish						
Part # (Add Finish)	Description	Length	Size	Glass Size	32D/630	32/629	28/628	314	314E BSP/WSP	4E	OptiCoat™
▲DRVS	Narrow Vertical Stile	Made to order up to 120"	1 1/16" – 2"	B, C	1,502.00	1,683.00	1,279.00	1,406.00	1,496.00	1,644.00	1,870.00
DRVS	Narrow Vertical Stile	Made to order up to 120"	1 1/16" – 2"	F, G	1,730.00	1,934.00	1,471.00	1,617.00	1,719.00	1,891.00	2,149.00

Note: Pile height of 3/16" supplied standard for typical 1/8" - 3/16" clearance. 3/8" tall pile is available upon request for larger clearances.

Piles are black only.

Note: Rixson 28 closer will require using the 554 arm for vertical stile applications.

▲Part of the ThermaGuard™ NFRC System.

Vertical Stile Gasketing			
Part #	Description	Length	Price
VSP-188.BLACK	3/16" Stile Pile	120"	33.00
VSP-375.BLACK	3/8" Stile Pile	120"	33.00
VSG-FLAT.BLACK	Flat Glazing Filler	120"	28.00

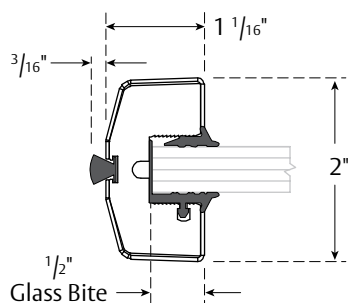

3/16" WEATHERING CLADDE

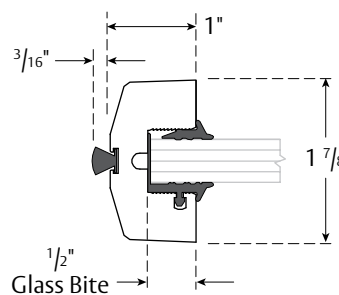

3/16" WEATHERING NON-CLADDE

Sidelite Glazing Hardware



(Sidelite rails are shown with pre-fit gasketing.)

Bottom Sidelite Rails with Gasket (Price Per Foot Starting at 36")				Finish						
Part # (Add Finish)	Profile	Height	Glass Sizes	32D/630	32/629	28/628	314	314E/BSP/WSP	4E	OptiCoat™
SRS-275AC-B	Square	2 3/4"	A - C	95.00	110.00	48.30	53.00	72.00	103.00	88.00
SRT-275AC-B	Tapered	2 3/4"	A - C	98.00	115.00	51.00	57.00	74.00	106.00	93.00
SRS-4AC-B	Square	4"	A - C	83.00	96.00	47.00	51.00	68.00	90.00	84.00
SRT-4AC-B	Tapered	4"	A - C	86.00	99.00	48.30	53.00	71.00	94.00	88.00
SRS-6AC-B	Square	6"	A - C	108.00	125.00	59.00	67.00	84.00	118.00	105.00
SRS-10AC-B	Square	10"	A - C	171.00	196.00	95.00	103.00	112.00	185.00	140.00
SRS-4DG-B	Square	4"	D - G	85.00	98.00	49.50	55.00	72.00	93.00	89.00
SRT-4DG-B	Tapered	4"	D - G	88.00	104.00	52.00	58.00	74.00	96.00	93.00

Pricing includes saddle, "roll in" gasket, and setting blocks – specify saddle height and glass thickness. Order form available.

Top Sidelite Rails with Gasket (Price Per Foot Starting at 36")				Finish						
Part # (Add Finish)	Profile	Height	Glass Sizes	32D/630	32/629	28/628	314	314E/BSP/WSP	4E	OptiCoat™
SRS-275AC-T	Square	2 3/4"	A - C	90.00	104.00	43.20	48.30	67.00	98.00	83.00
SRT-275AC-T	Tapered	2 3/4"	A - C	94.00	110.00	45.70	51.00	69.00	102.00	86.00
SRS-4AC-T	Square	4"	A - C	79.00	92.00	41.90	45.70	63.00	85.00	79.00
SRT-4AC-T	Tapered	4"	A - C	82.00	95.00	43.20	48.30	66.00	89.00	82.00
SRS-6AC-T	Square	6"	A - C	102.00	121.00	53.00	60.00	80.00	111.00	100.00
SRS-10AC-T	Square	10"	A - C	166.00	190.00	88.00	99.00	105.00	180.00	131.00
SRS-4DG-T	Square	4"	D - G	81.00	94.00	44.40	49.50	67.00	87.00	83.00
SRT-4DG-T	Tapered	4"	D - G	84.00	98.00	47.00	52.00	69.00	92.00	86.00

Pricing includes 1/8" saddle and "roll in" gasket – specify glass thickness. Order form available.

Sidelite End Caps (Each)				Finish						
Part # (Add Finish)	Profile	Height	Glass Sizes	32D/630	32/629	28/628	314	314E/BSP/WSP	4E	OptiCoat™
ECSS-275AC	Square	2 3/4"		49.30	56.00	26.60	30.50	48.40	53.00	60.00
ECST-275AC	Tapered	2 3/4"		49.30	56.00	26.60	30.50	48.40	53.00	60.00
ECSS-4AC	Square	4"		40.90	46.90	19.00	22.80	39.60	43.60	49.50
ECST-4AC	Tapered	4"		40.90	46.90	19.00	22.80	39.60	43.60	49.50
ECSS-6AC	Square	6"		86.00	99.00	55.00	61.00	81.00	89.00	102.00
ECSS-10AC	Square	10"		113.00	130.00	100.00	108.00	116.00	128.00	146.00
ECSS-4DF	Square	4"		51.00	57.00	28.00	30.50	48.40	53.00	60.00
ECST-4DF	Tapered	4"		51.00	57.00	28.00	30.50	48.40	53.00	60.00

Deduct 1/4" from rail length for each end cap.

Includes black "roll in" gasket – pre-fit gasket available upon request.

ASSA ABLOY

Experience a safer
and more open world

USA & Canada Prices Effective February 2, 2026 | Click Here for: [Canadian Tariffs](#)
The 2026 USA Price Book Tariff Adjustment will remain at 6.25% as previously communicated.
USA: 855 594 6989 • www.assaabloyglass.us | Canada: 800 461 3007 • www.assaabloydss.ca

Copyright © 2021-2026, ASSA ABLOY Accessories and Door Controls Group, Inc. All rights reserved. Reproduction in whole or in part without the express written permission of ASSA ABLOY Accessories and Door Controls Group, Inc. is prohibited.

Sidelite Saddles (Price Per Foot)				Finish				
Part # (Add Finish)	Description	SL Rail Height	Saddle Height	Mill	314	314E/BSP/WSP	4E	OptiCoat™
SAR-1500x188/375	Reversible Saddle	2 3/4" Sq	3/16", 3/8"	8.80	10.20	27.20	30.00	34.10
SAR-1500x250/750	Reversible Saddle	2 3/4" Sq	1/4", 3/4"	8.80	10.20	27.20	30.00	34.10
SAR-1500x500/625	Reversible Saddle	2 3/4" Sq	1/2", 5/8"	8.80	10.20	27.20	30.00	34.10
SAR-1875x188/375	Reversible Saddle	2 3/4" Tp, 4", 6", 10"	3/16", 3/8"	8.80	10.20	27.20	30.00	34.10
SAR-1875x250/750	Reversible Saddle	2 3/4" Tp, 4", 6", 10"	1/4", 3/4"	8.80	10.20	27.20	30.00	34.10
SAR-1875x500/625	Reversible Saddle	2 3/4" Tp, 4", 6", 10"	1/2", 5/8"	8.80	10.20	27.20	30.00	34.10
SAS-1500x125	Saddle 1 1/2" x 1/8"	2 3/4" Sq	1/8"	8.80	10.20	27.20	30.00	34.10
SAS-1875x125	Saddle 1 7/8" x 1/8"	2 3/4" Tp, 4", 6", 10"	1/8"	8.80	10.20	27.20	30.00	34.10

Sidelite Compatible Parts		
Part #	Description	Price
SBL-4PAD	4" Setting Block with Pad	2.60

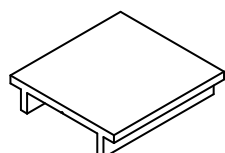

1/8" Saddle
(SAS-1875x125)

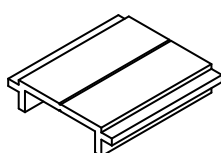

3/16", 3/8" Saddle
(SAR-1875x188/375)

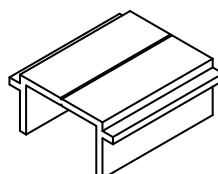

1/4", 3/4" Saddle
(SAR-1875x250/750)

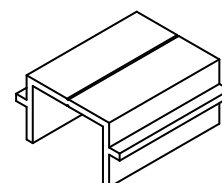

1/2", 5/8" Saddle
(SAR-1875x500/625)

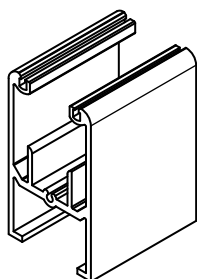

Square 2 3/4"
(SRS-275)

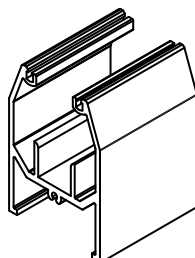

Tapered 2 3/4"
(SRT-275)

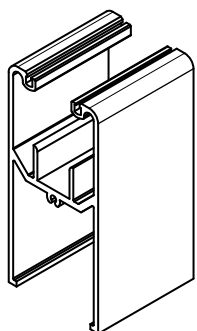

Square 4"
(SRS-4)

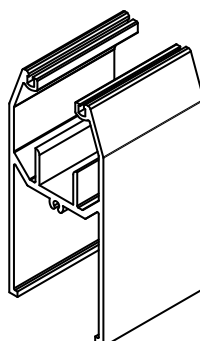

Tapered 4"
(SRT-4)

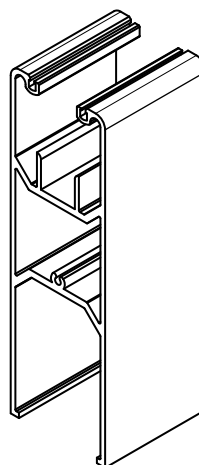

Square 6"
(SRS-6)

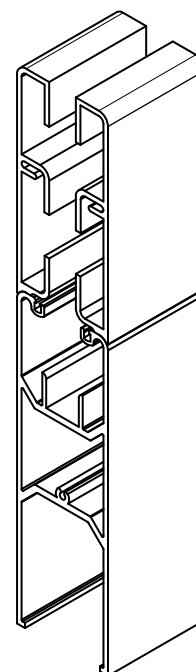

Square 10"
(SRS-10)

USA & Canada Prices Effective February 2, 2026 | Click Here for: [Canadian Tariffs](#)
 The 2026 USA Price Book Tariff Adjustment will remain at 6.25% as previously communicated.
 USA: 855 594 6989 • www.assaabloypass.com | Canada: 800 461 3007 • www.assaabloypass.ca

Copyright © 2021-2026, ASSA ABLOY Accessories and Door Controls Group, Inc. All rights reserved. Reproduction in whole or in part without the express written permission of ASSA ABLOY Accessories and Door Controls Group, Inc. is prohibited.

ASSA ABLOY

Experience a safer
and more open world

Sidelite Glazing Hardware (cont')

Dry U-Channel (Price Per Foot Starting at 36")			Finish						
Part # (Add Finish)	Height	Width	32D/630	32/629	28/628	314	314E/BSP/WSP	4E	OptiCoat™
UCD-0687x1625	1 ¹¹ / ₁₆ "	1 ⁵ / ₈ "	28.00	32.10	19.00	21.20	37.50	41.30	46.90
UCD-1625x1625	1 ⁵ / ₈ "	1 ⁵ / ₈ "	35.80	41.10	21.70	24.00	40.10	44.10	50.00
UCD-1625x1875	1 ⁵ / ₈ "	1 ⁷ / ₈ "	43.70	50.10	28.40	31.60	47.20	52.00	59.00

Includes "roll in" gasket – pre-fit gasket available upon request.

Dry U-Channel End Caps (Each)			Finish						
Part # (Add Finish)	Height	Width	32D/630	32/629	28/628	314	314E/BSP/WSP	4E	OptiCoat™
ECU-0687x1625	1 ¹¹ / ₁₆ "	1 ⁵ / ₈ "	19.60	22.40	16.30	18.10	33.80	37.10	42.20
ECU-1625x1625	1 ⁵ / ₈ "	1 ⁵ / ₈ "	22.00	25.40	17.70	19.60	35.30	38.90	44.10
ECU-1625x1875	1 ⁵ / ₈ "	1 ⁷ / ₈ "	27.40	31.10	24.50	27.10	42.40	46.60	53.00

2 Piece U-Channel (Price Per Foot Starting 36")			Finish						
Part # (Add Finish)	Height	Width	32D/630	32/629	28/628	314	314E/BSP/WSP	4E	OptiCoat™
UCD-1188x0875	1 ³ / ₁₆ "	7/8"	31.70	34.90	27.60	29.60	41.60	52.00	

Includes pre-fit gasket.

Dry U-Channel Gasketing (Price Per Roll)			
Part #	Glass Sizes	Roll Length	Price
GD-PREFIT-A.BLACK	A	500'	1,119.00
GD-PREFIT-B.BLACK	B, C	500'	1,119.00
GD-ROLLIN-B.BLACK	B, C	500'	1,119.00
*GD-WEDGESS.BLACK	B	100'	234.00

*2-Piece channel only.

Wet/Dry U-Channel (Price Per Foot Starting at 36")			Finish						
Part # (Add Finish)	Height	Width	32D/630	32/629	28/628	314	314E/BSP/WSP	4E	OptiCoat™
UWD-1000x1000	1"	1"	13.60	14.50	12.10	13.50	30.20	33.20	37.80
UWD-1000x1000 Stock 138"	1"	1"	131.00	136.00	116.00	130.00	289.00	318.00	362.00
UWD-1750x1000	1 ³ / ₄ "	1"	18.30	19.40	16.40	17.80	33.50	36.80	41.90
UWD-1750x1000 Stock 138"	1 ³ / ₄ "	1"	177.00	186.00	157.00	171.00	320.00	354.00	400.00
UWD-2000x1000	2"	1"	23.10	24.30	19.90	21.70	38.20	42.10	47.70
UWD-2000x1000 Stock 138"	2"	1"	222.00	232.00	190.00	209.00	367.00	404.00	459.00
UWD-1000x1250	1"	1 ¹ / ₄ "	15.20	15.90	13.40	15.00	31.60	34.70	39.50
UWD-1000x1250 Stock 138"	1"	1 ¹ / ₄ "	146.00	153.00	129.00	144.00	304.00	334.00	380.00
UWD-2000x1250	2"	1 ¹ / ₄ "	24.40	25.60	20.80	22.70	39.80	43.80	49.80
UWD-2000x1250 Stock 138"	2"	1 ¹ / ₄ "	233.00	246.00	200.00	218.00	382.00	421.00	477.00

Max length for OptiCoat™ is 140".

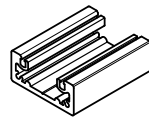

Dry U-Channel
(UCD-0687x1625)

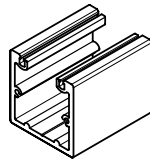

Dry U-Channel
(UCD-1625x1625)

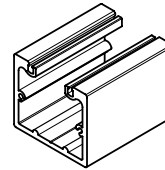

Dry U-Channel
(UCD-1625x1875)

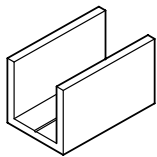

Wet/Dry U-Channel
(UWD-1000x1000)

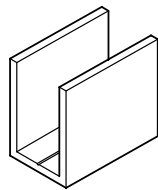

Wet/Dry U-Channel
(UWD-1750x1000)

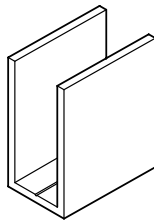

Wet/Dry U-Channel
(UWD-2000x1000)

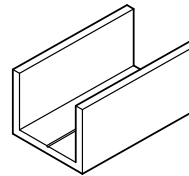

Wet/Dry U-Channel
(UWD-1000x1250)

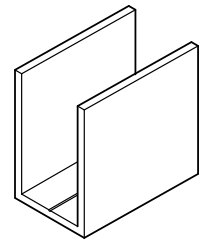

Wet/Dry U-Channel
(UWD-2000x1250)

ASSA ABLOY

Experience a safer
and more open world

USA & Canada Prices Effective February 2, 2026 | Click Here for: [Canadian Tariffs](#)
The 2026 USA Price Book Tariff Adjustment will remain at 6.25% as previously communicated.
USA: 855 594 6989 • www.assaabloyglass.us | Canada: 800 461 3007 • www.assaabloydss.ca

Copyright © 2021-2026, ASSA ABLOY Accessories and Door Controls Group, Inc. All rights reserved. Reproduction in whole or in part without the express written permission of ASSA ABLOY Accessories and Door Controls Group, Inc. is prohibited.

Wet/Dry U-Channel End Caps (Each)			Finish						
Part # (Add Finish)	Height	Width	32D/630	32/629	28/628	314	314E/BSP/WSP	4E	OptiCoat™
ECU-1000x1000	1"	1"	13.00	13.50	12.30	13.10	29.50	32.40	36.90
ECU-1750x1000	1 3/4"	1"	13.00	13.50	12.30	13.10	29.50	32.40	36.90
ECU-2000x1000	2"	1"	13.00	13.50	12.30	13.10	29.50	32.40	36.90
ECU-1000x1250	1"	1 1/4"	13.00	13.50	12.30	13.10	29.50	32.40	36.90
ECU-2000x1250	2"	1 1/4"	13.00	13.50	12.30	13.10	29.50	32.40	36.90

Wet/Dry U-Channel Gasketing - Black (Price Per Roll)			
Part #	Glass Sizes	Roll Length	Price
GD-WEDGE.BLACK	B, C, F	100'	224.00
GD-WEDGE-AD.BLACK	A, D, E	100'	441.00

Add for Miter Cuts		Finish			
Description	32D/32	28/314	314E/BSP/WSP	4E	OptiCoat™
2 3/4" Rail	50.00	35.00	35.00	50.00	35.00
4" Rail	60.00	45.00	45.00	60.00	45.00
6" Rail	75.00	60.00	60.00	75.00	60.00
10" Rail	100.00	85.00	85.00	100.00	85.00
Dry U-Channel (All Sizes)	45.00	30.00	30.00	45.00	30.00
Wet/Dry U-Channels (1" & 1 1/4" Wide)	30.00	30.00	30.00	30.00	30.00

Please specify miter angle and direction when ordering. Sidelite order form available.

2 3/4" Square Sidelite Rails
= 7/16" Bite Top and Bottom

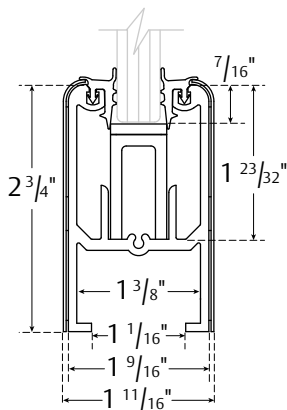

2 3/4" Tapered Sidelite Rails
= 9/16" Bite Top and Bottom

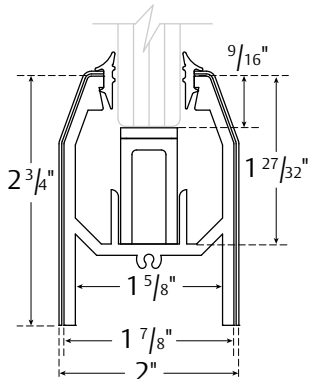

4", 6" Sidelite Rails
= 9/16" Bite Top and Bottom

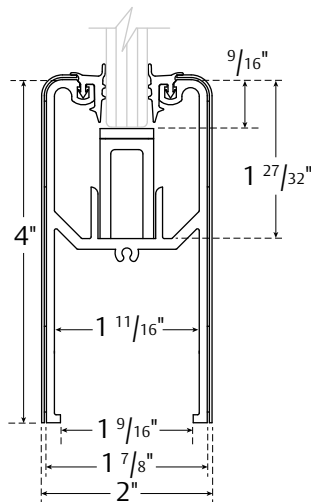

10" Sidelite Rails
= 4 9/16" Bite Top and Bottom

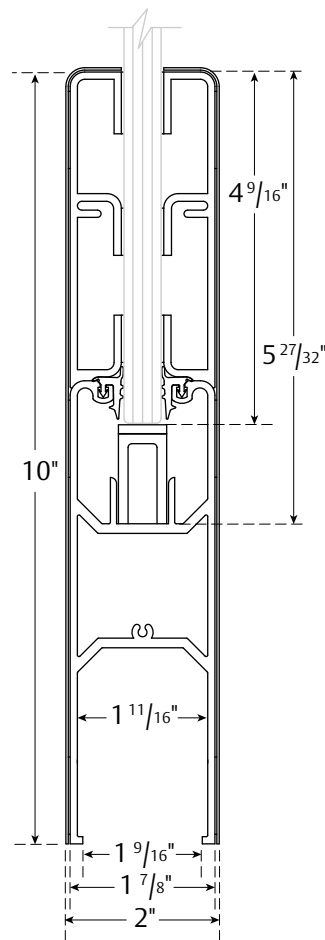

USA & Canada Prices Effective February 2, 2026 | Click Here for: [Canadian Tariffs](#)
The 2026 USA Price Book Tariff Adjustment will remain at 6.25% as previously communicated.
USA: 855 594 6989 • www.assaabloyglass.us | Canada: 800 461 3007 • www.assaabloydss.ca

Copyright © 2021-2026, ASSA ABLOY Accessories and Door Controls Group, Inc. All rights reserved. Reproduction in whole or in part without the express written permission of ASSA ABLOY Accessories and Door Controls Group, Inc. is prohibited.

ASSA ABLOY

Experience a safer
and more open world

Headers

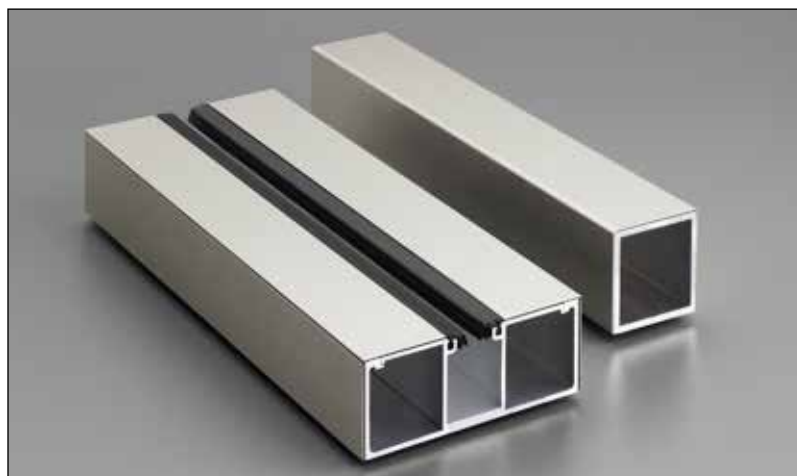

2-Piece Headers (Price Per Panel)					Finish						
Part # (Add Finish)	Prep Type	Ht.	Width	Standard Lengths	32D/630	32/629	28/628	314	314E/ BSP/WSP	4E	OptiCoat™
HDR-1750x4000-PIV	Pivot	1 3/4"	4"	24" to 48"	271.00	315.00	156.00	174.00	271.00	298.00	339.00
HDR-1750x4500-PIV	Pivot	1 3/4"	4 1/2"	24" to 48"	291.00	335.00	172.00	186.00	291.00	320.00	364.00
HDR-1750x4000-OHC	Closer	1 3/4"	4"	24" to 48"	287.00	329.00	172.00	186.00	291.00	320.00	364.00
HDR-1750x4500-OHC	Closer	1 3/4"	4 1/2"	24" to 48"	303.00	348.00	184.00	201.00	316.00	347.00	395.00
Sidelite Add Per Foot (Flat Bottom)					34.80	35.20	21.60	22.80	40.60	44.00	51.00
Add for Manual or 9100/9200 Electric Strike					150.00		125.00		150.00	125.00	
Add for 1600 Electric Strike Prep					200.00		175.00		200.00	175.00	
Add for Other ASSA ABLOY Preps					50.00		50.00		50.00	50.00	
Add for Standard Competitor Closer/Pivot Prep					75.00		75.00		75.00	75.00	
‡Add Miter Cut					60.00		45.00		60.00	45.00	

2-Piece Sidelite Headers with Gasket (Price Per Foot)					Finish						
Part # (Add Finish)	Glass Sizes	Ht.	Width	Standard Lengths	32D/630	32/629	28/628	314	314E/ BSP/WSP	4E	OptiCoat™
HDR-1750x4000-SDL	A-C	1 3/4"	4"	Per Foot	49.30	56.00	34.40	37.00	57.00	62.00	72.00
HDR-1750x4500-SDL	A-C	1 3/4"	4 1/2"	Per Foot	57.00	69.00	39.70	43.70	63.00	70.00	79.00
HDR-1750x4000-SDL	D-F	1 3/4"	4"	Per Foot	58.00	70.00	39.70	43.70	63.00	70.00	79.00
HDR-1750x4500-SDL	D-F	1 3/4"	4 1/2"	Per Foot	68.00	76.00	43.70	47.60	67.00	73.00	83.00

ASSA ABLOY

Experience a safer
and more open world

USA & Canada Prices Effective February 2, 2026 | Click Here for: [Canadian Tariffs](#)
The 2026 USA Price Book Tariff Adjustment will remain at 6.25% as previously communicated.
USA: 855 594 6989 • www.assaabloyglass.us | Canada: 800 461 3007 • www.assaabloydss.ca

Copyright © 2021-2026, ASSA ABLOY Accessories and Door Controls Group, Inc. All rights reserved. Reproduction in whole or in part without the express written permission of ASSA ABLOY Accessories and Door Controls Group, Inc. is prohibited.

Solid Headers (Price Per Panel)					Finish						
Part # (Add Finish)	Prep Type	Ht.	Width	Standard Lengths	32D/630	32/629	28/628	314	314E/ BSP/WSP	4E	OptiCoat™
HDS-1750x4000-PIV	Pivot	1 3/4"	4"	24" to 48"	548.00	629.00	314.00	344.00	368.00	593.00	461.00
HDS-1750x4500-PIV	Pivot	1 3/4"	4 1/2"	24" to 48"	579.00	665.00	336.00	370.00	396.00	627.00	495.00
HDS-2000x2000-PIV	Pivot	2"	2"	24" to 48"	523.00	602.00	280.00	309.00	330.00	567.00	412.00
▲HDS-2000x6000-PIV	Pivot	2"	6"	24" to 48"	718.00	825.00	445.00	489.00	524.00	778.00	655.00
HDS-1750x4000-OHC	Closer	1 3/4"	4"	24" to 48"	623.00	717.00	396.00	436.00	466.00	675.00	582.00
HDS-1750x4500-OHC	Closer	1 3/4"	4 1/2"	24" to 48"	647.00	745.00	415.00	457.00	487.00	701.00	608.00
▲HDS-2000x6000-OHC	Closer	2"	6"	24" to 48"	758.00	873.00	502.00	550.00	590.00	822.00	737.00
Sidelite Add Per Foot (Flat Bottom)					51.00	57.00	33.00	34.00	52.00	55.00	66.00
Sidelite Add Per Foot (Slotted Bottom)					82.00	94.00	57.00	59.00	82.00	89.00	103.00
Add for Deadbolt Strike, Offset Pivot, Overhead Stop or Mag Lock Prep					100.00			75.00		100.00	75.00
Add for Manual or 9100/9200 Electric Strike (6" Deep Tube)					75.00			50.00		75.00	50.00
Add for Manual or 9100/9200 Electronic Strike (4" or 4 1/2" Deep Tube)					100.00			75.00		100.00	75.00
Add for Electric Strike Prep (6" Deep Tube)					100.00			75.00		100.00	75.00
Add for Electric Strike Prep (4" or 4 1/2" Deep Tube)					200.00			175.00		200.00	175.00
‡Add Miter Cut					60.00			45.00		60.00	45.00
Add for Custom Closer Prep					200.00			150.00		200.00	150.00
Add for Other ASSA ABLOY Prep					50.00			50.00		50.00	50.00
Add for Rixon 345 Pivot Prep					125.00			125.00		125.00	125.00
Add for Standard Competitor Closer/Pivot Prep					75.00			75.00		75.00	75.00
*Add for Door Contact Prep					75.00			50.00		75.00	50.00

Order form available. Custom Powder Coat available (call for price). Double price for pair.

Add \$75 list per item/per door to install ASSA ABLOY hardware into header.

‡Please specify miter angle and direction when ordering. For competitor panic prep, double the panic prep price.

▲Part of the ThermaGuard™ NFRC System.

*Standard Door Contact Prep is for Securitron DPS-M.

Floating Headers

Solid Floating Headers (Price Per Panel)					Finish						
Part # (Add Finish)	Prep Type	Height	Width	Standard Lengths	32D/630	32/629	28/628	314	314E/ BSP/WSP	4E	OptiCoat™
HDF-1750x4000-PIV	Pivot	1 3/4"	4"	36" to 60"	812.00	933.00	687.00	709.00	861.00	947.00	1,076.00
HDF-1750x4500-PIV	Pivot	1 3/4"	4 1/2"	36" to 60"	838.00	964.00	708.00	739.00	890.00	980.00	1,113.00
HDF-2000x6000-PIV	Pivot	2"	6"	36" to 60"	1,036.00	1,192.00	940.00	997.00	1,180.00	1,299.00	1,476.00
HDF-1750x4000-OHC	Closer	1 3/4"	4"	36" to 60"	836.00	961.00	708.00	730.00	890.00	980.00	1,113.00
HDF-1750x4500-OHC	Closer	1 3/4"	4 1/2"	36" to 60"	863.00	993.00	729.00	762.00	917.00	1,009.00	1,147.00
HDF-2000x6000-OHC	Closer	2"	6"	36" to 60"	1,112.00	1,278.00	1,007.00	1,070.00	1,267.00	1,394.00	1,584.00
Sidelite Wall Mount - Add Per Foot (Slotted Bottom)					123.00	140.00	75.00	79.00	120.00	131.00	150.00
Sidelite Wall Mount - Add Per Foot (Flat Bottom)					92.00	104.00	51.00	57.00	89.00	98.00	112.00
Add for Deadbolt Strike, Overhead Stop or Mag Lock Prep					100.00		75.00		100.00		75.00
Add for Panic Manual or 9100/9200 Electronic Strike (6" Deep Tube)					75.00		50.00		75.00		50.00
Add for Panic Manual or 9100/9200 Electronic Strike (4" or 4 1/2" Deep Tube)					100.00		75.00		100.00		75.00
Add for Electric Strike Prep (6" Deep Tube)					100.00		75.00		100.00		75.00
Add for Electric Strike Prep (4" or 4 1/2" Deep Tube)					200.00		175.00		200.00		175.00
Add for Offset Pivot or Custom Closer Prep					200.00		150.00		200.00		150.00
Add for Other ASSA ABLOY Prep					50.00		50.00		50.00		50.00
Add for Standard Competitor Closer/Pivot Prep					75.00		75.00		75.00		75.00
*Add for Door Contact Prep					75.00		50.00		75.00		50.00

Custom Powder Coat available (call for price).

Double price for pair.

Add \$75 list to install ASSA ABLOY closer into header.

Order form available.

*Standard Door Contact Prep is for Securitron DPS-M.

ASSA ABLOY

Experience a safer
and more open world

USA & Canada Prices Effective February 2, 2026 | Click Here for: [Canadian Tariffs](#)
The 2026 USA Price Book Tariff Adjustment will remain at 6.25% as previously communicated.
USA: 855 594 6989 • www.assaabloyglass.us | Canada: 800 461 3007 • www.assaabloydss.ca

Copyright © 2021-2026, ASSA ABLOY Accessories and Door Controls Group, Inc. All rights reserved. Reproduction in whole or in part without the express written permission of ASSA ABLOY Accessories and Door Controls Group, Inc. is prohibited.



Two-Piece Header
(HDR-1750x4000)



Two-Piece Header
(HDR-1750x4500)



Solid Header
(HDS-1750x4000)



Solid Header
(HDS-1750x4500)

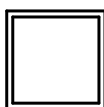

Solid Header
(HDS-2000x2000)

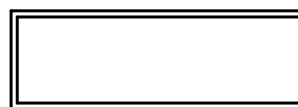

Solid Header
(HDS-2000x6000)

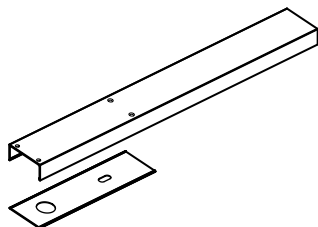

Overhead Closer Header
(HDR-1750x4000-OHC)

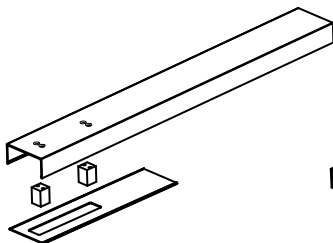

Pivot Header
(HDR-1750x4500-PIV)

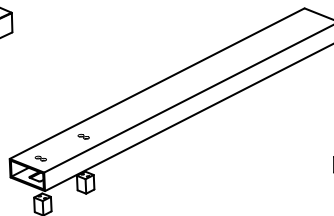

Solid Header
(HDS-1750x4000-PIV)

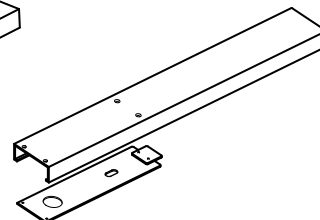

Solid Header
(HDS-1750x4500-OHC)

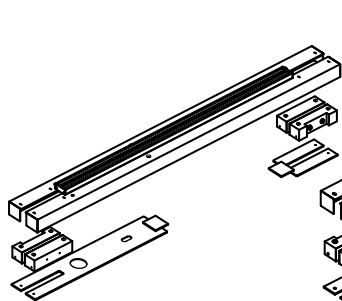

Floating Header
(HDF-1750x4500-OHC)
Sidelite Both

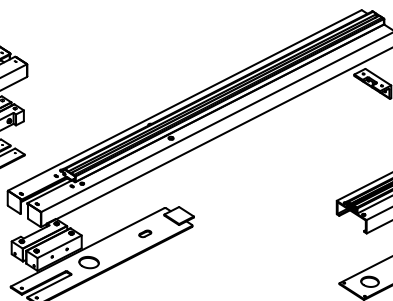

Floating Header
(HDF-1750x4500-OHC)
Sidelite Left

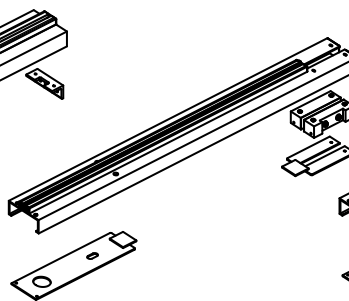

Floating Header
(HDF-1750x4500-OHC)
Sidelite Right

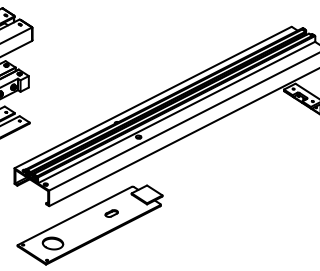

Floating Header
(HDF-1750x4500-OHC)
Sidelite None

Accessories & Thresholds

Header Accessories			Finish						
Part # (Add Finish)	Description	Length	32D/630	32/629	28/628	314	314E/BSP/WSP	4E	OptiCoat™
ECH-1750x4000	1 3/4" x 4" End Cap		21.60	25.30	22.80	25.40	43.40	47.70	54.00
ECH-1750x4500	1 3/4" x 4 1/2" End Cap		21.60	25.30	22.80	25.40	43.40	47.70	54.00
ECH-2000x2000	2" x 2" End Cap		14.40	15.70	14.00	15.20	33.50	36.80	41.90
ECH-2000x6000	2" x 6" End Cap		24.10	27.60	25.40	26.60	44.50	49.00	56.00
DS-3000	Single Acting Door Stop (Single Dr)	3"	15.70	18.00	14.00		33.50	36.80	41.90
DS-6000	Single Acting Door Stop (Double Dr)	6"	24.10	26.40	17.80		37.10	40.90	46.40
GD-WEDGE.BLACK	Solid Header Gasketing	100'	Black Only			224.00			

Thresholds (24" to 48") (Price Per Panel)				Finish			Sidelite Add Per Foot		
Part # (Add Finish)	Prep Type	Height	Width	MILL	314E/BSP/WSP	OptiCoat™	MILL	314E/BSP/WSP	OptiCoat™
THOLD-170A	Blank	1/2"	4"	117.00	135.00	169.00	22.60	44.30	56.00
THOLD-171A	Blank	1/2"	5"	135.00	158.00	197.00	31.10	51.00	64.00
THOLD-176A	Blank	1/2"	7"	190.00	217.00	272.00	49.50	71.00	89.00
THOLD-170A-PIV	Pivot	1/2"	4"	166.00	194.00	243.00	22.60	44.30	56.00
THOLD-171A-PIV	Pivot	1/2"	5"	193.00	226.00	282.00	31.10	51.00	64.00
THOLD-176A-PIV	Pivot	1/2"	7"	270.00	312.00	390.00	49.50	71.00	89.00
THOLD-170A-P300	300lb Pivot	1/2"	4"	258.00	300.00	376.00	22.60	44.30	56.00
THOLD-171A-P300	300lb Pivot	1/2"	5"	284.00	330.00	413.00	46.60	51.00	64.00
THOLD-176A-P300	300lb Pivot	1/2"	7"	357.00	418.00	523.00	49.50	71.00	89.00
THOLD-170A-CLSR	Closer	1/2"	4"	258.00	300.00	376.00	22.60	44.30	56.00
THOLD-171A-CLSR	Closer	1/2"	5"	284.00	330.00	413.00	46.60	51.00	64.00
THOLD-176A-CLSR	Closer	1/2"	7"	357.00	418.00	523.00	49.50	71.00	89.00

Double price for pair.

Specify Closer or Pivot type for order. If using competitor hardware, please provide template.

ASSA ABLOY

Experience a safer
and more open world

USA & Canada Prices Effective February 2, 2026 | Click Here for: [Canadian Tariffs](#)
The 2026 USA Price Book Tariff Adjustment will remain at 6.25% as previously communicated.
USA: 855 594 6989 • www.assaabloyglass.us | Canada: 800 461 3007 • www.assaabloydss.ca

Copyright © 2021-2026, ASSA ABLOY Accessories and Door Controls Group, Inc. All rights reserved. Reproduction in whole or in part without the express written permission of ASSA ABLOY Accessories and Door Controls Group, Inc. is prohibited.

Jamb Tubes

2-Piece Jamb Tubes (Per Foot)					Finish						
Part # (Add Finish)	Height	Width	Cladded	Jamb Prep	32D/630	32/629	28/628	314	314E BSP/WSP	4E	OptiCoat™
HDRJ-1750x4000	1 3/4"	4"	3 Sided	Flat	62.00	81.00	24.10	26.40	38.60	69.00	48.00
HDRJ-1750x4000	1 3/4"	4"	3 Sided	Pocket	64.00	76.00	34.20	34.30	54.00	70.00	68.00
HDRJ-1750x4000	1 3/4"	4"	4 Sided	Flat	95.00	129.00	24.10	26.40	38.60	103.00	48.00
HDRJ-1750x4000	1 3/4"	4"	4 Sided	Pocket	90.00	120.00	34.20	37.60	54.00	98.00	68.00
HDRJ-1750x4500	1 3/4"	4 1/2"	3 Sided	Flat	67.00	84.00	26.40	29.10	43.10	71.00	54.00
HDRJ-1750x4500	1 3/4"	4 1/2"	3 Sided	Pocket	64.00	77.00	36.60	40.20	58.00	70.00	73.00
HDRJ-1750x4500	1 3/4"	4 1/2"	4 Sided	Flat	98.00	135.00	26.40	29.10	43.10	107.00	54.00
HDRJ-1750x4500	1 3/4"	4 1/2"	4 Sided	Pocket	95.00	126.00	36.60	40.20	58.00	103.00	73.00

Solid Jamb Tubes (Per Foot)					Finish						
Part # (Add Finish)	Height	Width	Cladded	Jamb Prep	32D/630	32/629	28/628	314	314E BSP/WSP	4E	OptiCoat™
HDSJ-1750x4000	1 3/4"	4"	3 Sided	Flat	62.00	82.00	25.20	27.80	33.70	69.00	42.00
HDSJ-1750x4000	1 3/4"	4"	3 Sided	Pocket	64.00	77.00	35.40	38.90	43.50	70.00	54.00
HDSJ-1750x4000	1 3/4"	4"	4 Sided	Flat	95.00	130.00	25.20	27.80	33.70	103.00	42.00
HDSJ-1750x4000	1 3/4"	4"	4 Sided	Pocket	92.00	121.00	35.40	38.90	43.50	99.00	54.00
HDSJ-1750x4500	1 3/4"	4 1/2"	3 Sided	Flat	67.00	85.00	29.70	32.80	43.60	71.00	54.00
HDSJ-1750x4500	1 3/4"	4 1/2"	3 Sided	Pocket	67.00	77.00	39.90	44.00	53.00	71.00	67.00
HDSJ-1750x4500	1 3/4"	4 1/2"	4 Sided	Flat	99.00	136.00	29.70	32.80	43.60	108.00	54.00
HDSJ-1750x4500	1 3/4"	4 1/2"	4 Sided	Pocket	96.00	126.00	39.90	43.90	53.00	104.00	67.00
HDSJ-2000x2000	2"	2"	3 Sided	Flat	55.00	71.00	20.70	22.70	26.30	60.00	33.00
HDSJ-2000x2000	2"	2"	3 Sided	Pocket	60.00	73.00	30.70	33.70	36.20	67.00	45.00
HDSJ-2000x2000	2"	2"	4 Sided	Flat	80.00	103.00	20.70	22.70	26.30	86.00	33.00
HDSJ-2000x2000	2"	2"	4 Sided	Pocket	88.00	118.00	30.70	33.70	36.20	96.00	45.00
HDSJ-2000x6000	2"	6"	3 Sided	Flat	76.00	99.00	37.00	40.80	55.00	82.00	69.00
HDSJ-2000x6000	2"	6"	3 Sided	Pocket	77.00	87.00	47.10	52.00	64.00	83.00	81.00
HDSJ-2000x6000	2"	6"	4 Sided	Flat	113.00	157.00	37.00	40.80	55.00	122.00	69.00
HDSJ-2000x6000	2"	6"	4 Sided	Pocket	119.00	163.00	47.10	52.00	64.00	128.00	81.00
Add for Top Clips and Holes Preps					275.00	275.00	225.00	225.00	225.00	275.00	225.00
Add for Top Clips and Notch Prep					295.00	295.00	260.00	260.00	260.00	295.00	260.00
Add for Bottom Block and Prep					275.00	275.00	185.00	185.00	185.00	275.00	185.00
Add for Manual Strike Prep					150.00	150.00	75.00	75.00	75.00	150.00	75.00
Add for Electric Strike Prep (Includes dust box for 1600)					250.00	250.00	125.00	125.00	125.00	250.00	125.00
Add for Custom Prep					250.00	250.00	150.00	150.00	150.00	250.00	150.00

Order form available.
 Custom Powder Coat Available (call for price).

Jamb Tubes (cont')

Jamb Tube Accessories	Finish					
	32D/630	32/629	28/628	314E/BSP/WSP	4E	OptiCoat™
Part #						
HD-TOPCLIP	98.00			Mill Finish		
JAMB-BTMLK-2000	147.00			Mill Finish		
JAMB-BTMLK-1750	137.00			Mill Finish		
ESK-1600 (Includes Faceplate)	634.00					
*MLSK (Mortise Lock Strike Plate)	62.00	76.00		93.00	102.00	93.00

*Specify jamb tube size when ordering.

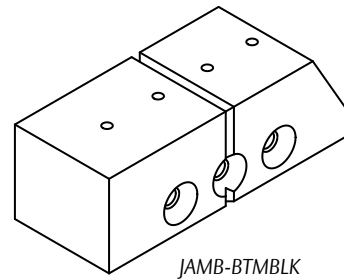
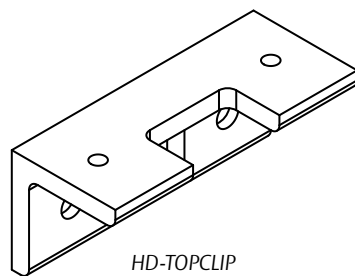
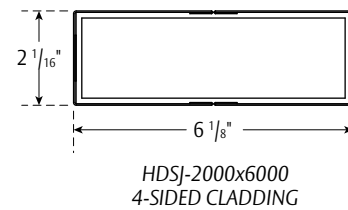
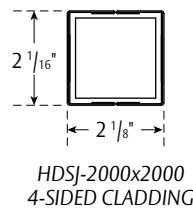
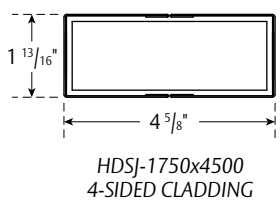
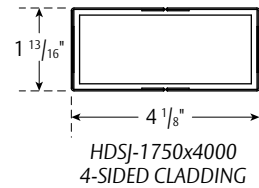
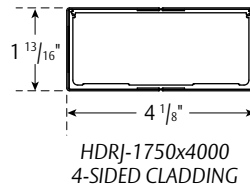
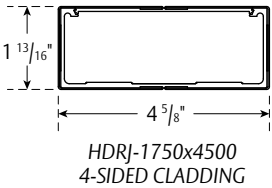
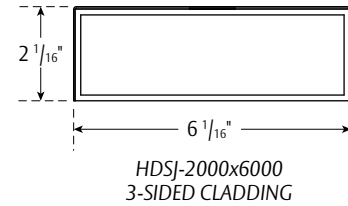
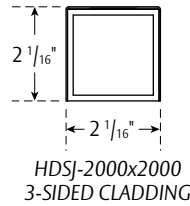
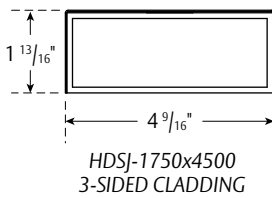
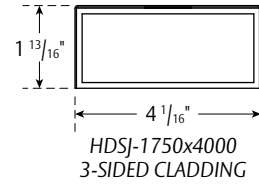
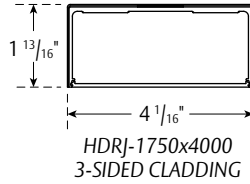
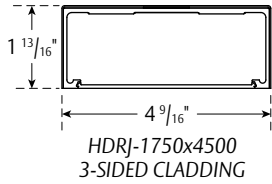

ASSA ABLOY

Experience a safer
and more open world

USA & Canada Prices Effective February 2, 2026 | Click Here for: [Canadian Tariffs](#)
The 2026 USA Price Book Tariff Adjustment will remain at 6.25% as previously communicated.
USA: 855 594 6989 • www.assaabloyglass.us | Canada: 800 461 3007 • www.assaabloydss.ca

Copyright © 2021-2026, ASSA ABLOY Accessories and Door Controls Group, Inc. All rights reserved. Reproduction in whole or in part without the express written permission of ASSA ABLOY Accessories and Door Controls Group, Inc. is prohibited.

Patch Fittings



Patch Fittings				Finish					
Part # (Add Finish)	Where Used	Glass Sizes	Incl Parts	32D/630	32/629	28/628	314E BSP/WSP	4E	OptiCoat™
*PFD-10BC	Door Bottom	B, C	Pivot/Closer Ins	84.00	96.00	68.00	94.00	103.00	118.00
*PFD-20BC	Door Top	B, C	Pivot Ins	81.00	93.00	62.00	88.00	97.00	110.00
*PFD-22BC	Door Top	B, C	OHC Ins	86.00	98.00	71.00	97.00	106.00	121.00
PFT-34BC-P	Transom Patch	B, C	Wall Bracket, Pivot	178.00	205.00	104.00	141.00	192.00	177.00
PFT-34BC-S	Transom Patch	B, C	Wall Bracket, Stop	178.00	205.00	104.00	141.00	192.00	177.00
PFT-34BC-B	Transom Patch	B, C	Wall Bracket, Blank	173.00	201.00	102.00	137.00	187.00	172.00
PFT-40BC-P	Transom/SL	B, C	Pivot Ins	167.00	192.00	124.00	166.00	184.00	208.00
PFT-40BC-S	Transom/SL	B, C	Stop Ins	167.00	192.00	124.00	166.00	184.00	208.00
PFT-40BC-B	Transom/SL	B, C	Blank Ins	164.00	187.00	120.00	162.00	179.00	203.00
PFT-60BC	Transom/SL	B, C	Stop, Blank	102.00	120.00	64.00	94.00	103.00	118.00
PFT-70BC	Transom Stop	B, C	Stop, Blank	96.00	111.00	76.00	102.00	113.00	128.00
PFD-100LBC	Bottom Patch Lock	B, C		193.00	223.00	134.00	182.00	210.00	228.00

*Only PFD 10, 20 and 22 are available for 3/8" glass. Specify 3/8" glass when ordering and add \$10.

Patch Fittings (cont')

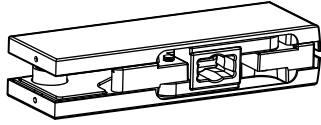

Bottom Patch (PFD-10)

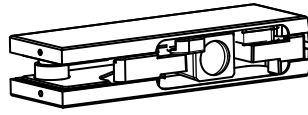

Top Patch (PFD-20)

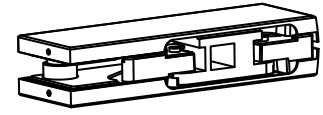

Top Patch (PFD-22)

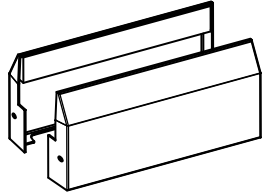

Tapered Patch Fitting Covers
(PFD-10/20/22-TAPCVR)

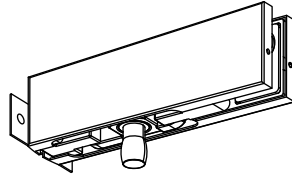

Transom Patch with Wall Bracket
(PFT-34)

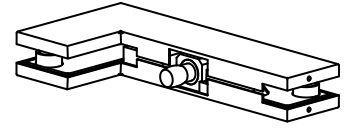

Sidelite Transom Patch
(PFT-40)

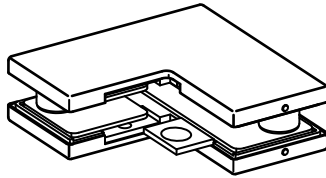

Sidelite Transom Patch
(PFT-60)

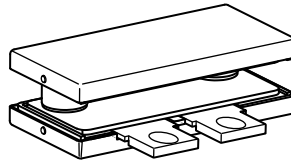

Transom Stop Patch
(PFT-70)

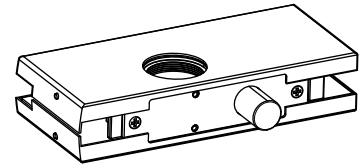

Patch Lock
(PFD-100L)

Patch Accessories		Finish					
Part # (Add Finish)	Description	32D/630	32/629	28/628	314E/BSP/WSP	4E	OptiCoat™
PFD-10/20/22-TAPCVR	Tapered Covers (Set of 2)	75.00		67.00	82.00	90.00	103.00
PFD-LOCKCYL	1" Cylinder w/Collar	28.90	28.90	28.90	48.00	53.00	60.00
PFD-LOCKTT	1" Thumbturn w/Collar	28.90	28.90	28.90	48.00	53.00	60.00
Part # (Add Finish)	Description		26D/626	26/625	314E/BSP/WSP		
*570	Dust Proof Strike		23.20	29.70	48.40		60.00

*Use Accessories Price Book multiplier for prices on this product.

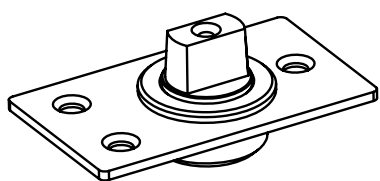

Floor Mount Pivot
(PF-FM-PIVOT)

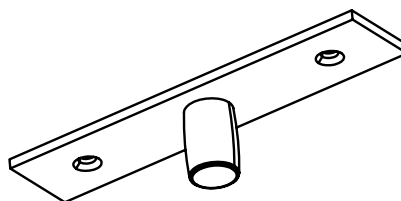

Surface Mount Pivot
(PF-SM-PIVOT)

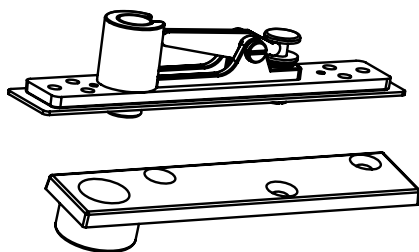

Walking Beam Pivot
(PV-WALKBEAM)

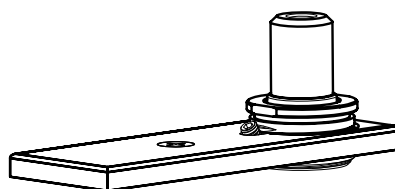

Adjustable Pivot
(PF-ADJ-PIV)

Panic Devices

Sold Through:  Authorized Channel Partner
ASSA ABLOY



Glass Panic Device				Finish								
Part # (Add Finish)	Latches	Mating Handle Shape	Mating Handle Length	32D/630	32/629	32D316	32316	32/32D*	314E BSP/WSP	32/BSP	4E	OptiCoat™
PDU8000	Up	None	None									
PDU8000-1	Up	L-Shape	Full									
PDU8000-2	Up	L-Shape	Half									
PDU8000-3	Up	Vertical	Full									
PDU8000-4	Up	Vertical	Half									
PDU8000-5	Up	Vertical	Short									
PDU8000-6	Up	Horizontal	Full									

*Panic Pricing
only available to
Authorized Channel
Partners.*

If door size is over 42" wide or 114" tall there is a \$360 add on price.
Order form available.

"PUSH" Infill Pricing	Price
BLACK (Standard)	
WHITE	22.00
CUSTOM	216.00
NO FILL	

Infill not available on US32. Infill is available on US32D and powdercoat options.

Panic Mounting Spare Parts Kit	Price
PDU8000	364.00

Cylinder Options	Price
Mortise Cylinder	
7-pin SFIC Housing w/Plastic Construction Core	
Special Order (Keyed Alike) (4 week minimum lead time)	52.00
Customer Supplied Cylinder/Swap In Field	23.00
Dummy Cylinder Housing	
*Non-Keyed Function (Blank Escutcheon Plate Provided)	
Keyed Construction Core for 7-pin SFIC Cylinder (Standard)	

*Only available on PDU8000 and PDU8000-6.

Panic Additional Options	Price
Security Dogging	52.00
Bent End Return (Panic side only)	250.00
2-piece Modular Panic	*
REX Monitoring	650.00

*For pricing use standard panic pricing.

ASSA ABLOY

Experience a safer
and more open world

USA & Canada Prices Effective February 2, 2026 | Click Here for: [Canadian Tariffs](#)
The 2026 USA Price Book Tariff Adjustment will remain at 6.25% as previously communicated.
USA: 855 594 6989 • www.assaabloyglass.us | Canada: 800 461 3007 • www.assaabloydss.ca
Copyright © 2021-2026, ASSA ABLOY Accessories and Door Controls Group, Inc. All rights reserved. Reproduction in whole or in part without the express written permission of ASSA ABLOY Accessories and Door Controls Group, Inc. is prohibited.

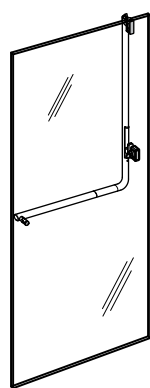

PDU8000

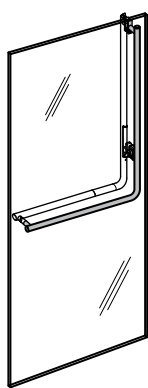

PDU8000-1

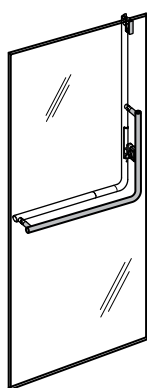

PDU8000-2

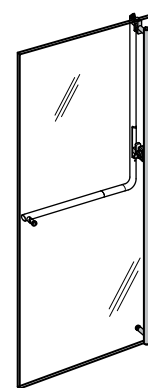

PDU8000-3

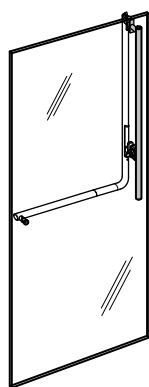

PDU8000-4

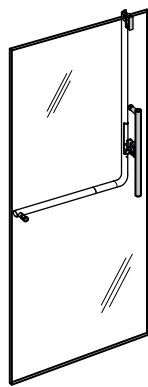

PDU8000-5

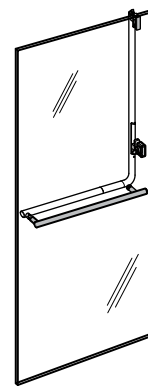

PDU8000-6

Panic Strike Kits (Strike, Adapter Plate, Cover)					Finish						
Part # (Add Finish)	Description	Keeper Length	Voltage	Mode	32D/630	32/629	32D316	32316	314E BSP/WSP	4E	OptiCoat™
ESK-SGL-24D	Single Door	3/4"	24V DC	Fail Secure	1,266.00	1,456.00	1,329.00	1,481.00	1,496.00	1,496.00	1,869.00
ESK-DBL-24D	Double Door	3/4"	24V DC	Fail Secure	2,532.00	2,913.00	2,659.00	2,962.00	2,992.00	2,992.00	3,740.00
ESK-SGL-12D	Single Door	3/4"	12V DC	Fail Secure	1,266.00	1,456.00	1,329.00	1,481.00	1,496.00	1,496.00	1,869.00
ESK-DBL-12D	Double Door	3/4"	12V DC	Fail Secure	2,532.00	2,913.00	2,659.00	2,962.00	2,992.00	2,992.00	3,740.00
ESK-SGL-24D-FS	Single Door	3/4"	24V DC	Fail Safe	1,266.00	1,456.00	1,329.00	1,481.00	1,496.00	1,496.00	1,869.00
ESK-DBL-24D-FS	Double Door	3/4"	24V DC	Fail Safe	2,532.00	2,913.00	2,659.00	2,962.00	2,992.00	2,992.00	3,740.00
ESK-SGL-12D-FS	Single Door	3/4"	12V DC	Fail Safe	1,266.00	1,456.00	1,329.00	1,481.00	1,496.00	1,496.00	1,869.00
ESK-DBL-12D-FS	Double Door	3/4"	12V DC	Fail Safe	2,532.00	2,913.00	2,659.00	2,962.00	2,992.00	2,992.00	3,740.00
MSK-SGL	Single Door				222.00	255.00	235.00	261.00	256.00	256.00	320.00
MSK-DBL	Double Door				319.00	366.00	335.00	373.00	366.00	366.00	457.00
SL100	Security Latch Adapter	Single Manual Strike			2,511.00	2,887.00			2,972.00	2,972.00	3,716.00
		Double Manual Strike			5,021.00	5,772.00			5,944.00	5,944.00	7,430.00
AC-RECTIFIER Adder	AC Converter for Electric Strike				93.00						
ES-SMARTPACIII	Power Controller				142.00						
LCBMA	Door Monitoring				191.00						
ESK-1600-SGL	Single Door	1"	12V/24V AC/DC	Fail Secure or Fail Safe	1,266.00	1,456.00	1,329.00	1,481.00	1,496.00	1,496.00	1,869.00
ESK-1600-DBL	Double Door	1"	12V/24V AC/DC	Fail Secure or Fail Safe	2,532.00	2,913.00	2,659.00	2,962.00	2,992.00	2,992.00	3,740.00
ESK-9100	Single Door	1"	12V/24V AC/DC	Fail Secure or Fail Safe	962.00	1,142.00			1,046.00	1,151.00	1,308.00
ESK-9200	Double Door	1"	12V/24V AC/DC	Fail Secure or Fail Safe	1,805.00	2,105.00			1,937.00	2,346.00	2,422.00
LM/LMS	Lock Monitor				191.00						

USA & Canada Prices Effective February 2, 2026 | Click Here for: [Canadian Tariffs](#)
 The 2026 USA Price Book Tariff Adjustment will remain at 6.25% as previously communicated.
 USA: 855 594 6989 • www.assaabloyglass.us | Canada: 800 461 3007 • www.assaabloydss.ca

Copyright © 2021-2026, ASSA ABLOY Accessories and Door Controls Group, Inc. All rights reserved. Reproduction in whole or in part without the express written permission of ASSA ABLOY Accessories and Door Controls Group, Inc. is prohibited.

ASSA ABLOY

Experience a safer
and more open world

Panic Devices (cont')

310-1 Electric Strikes (Body Only)					
Part #	Description	Keeper Length	Voltage	Mode	Price
ES-310-1-3/4-24D	Electric Strike	3/4"	24V DC	Fail Secure	729.00
ES-310-1-3/4-12D	Electric Strike	3/4"	12V DC	Fail Secure	729.00
ES-310-1-3/4-24D-FS	Electric Strike	3/4"	24V DC	Fail Safe	729.00
ES-310-1-3/4-12D-FS	Electric Strike	3/4"	12V DC	Fail Safe	729.00
LCBMA	Door Monitoring				191.00

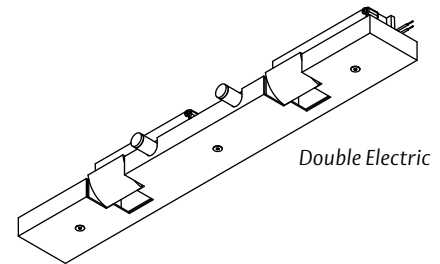
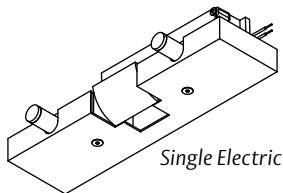
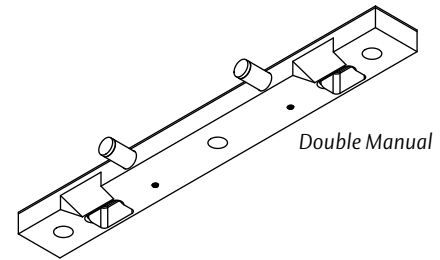
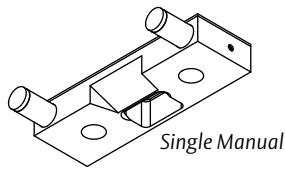
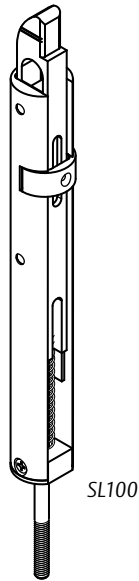

Dummy Pulls (Pricing is for back to back set)			Finish									
Part # (Add Finish)	Mating Handle Shape	Mating Handle Length	32D/630	32/629	32D316	32316	32/32D 629/630	314E BSP/WSP	32/BSP	4E	OptiCoat™	
DDU8000	None	None	1,398.00	1,566.00	1,501.00	1,681.00	1,636.00	1,771.00	1,863.00	1,948.00	2,214.00	
DDU8000-1	L-Shape	Full	1,959.00	2,194.00	2,103.00	2,356.00	2,293.00	2,479.00	2,608.00	2,727.00	3,099.00	
DDU8000-2	L-Shape	Half	1,908.00	2,137.00	2,048.00	2,294.00	2,232.00	2,415.00	2,541.00	2,655.00	3,019.00	
DDU8000-3	Vertical	Full	2,004.00	2,244.00	2,151.00	2,409.00	2,345.00	2,534.00	2,668.00	2,789.00	3,168.00	
DDU8000-4	Vertical	Half	1,868.00	2,092.00	2,005.00	2,246.00	2,186.00	2,366.00	2,489.00	2,603.00	2,958.00	
DDU8000-5	Vertical	Short	1,766.00	1,978.00	1,896.00	2,124.00	2,065.00	2,237.00	2,355.00	2,461.00	2,797.00	
DDU8000-6	Horizontal	Full	1,766.00	1,978.00	1,896.00	2,124.00	2,065.00	2,237.00	2,355.00	2,461.00	2,797.00	

Order form available.
 If door size is over 42" wide or 114" tall there is a \$360 add on price.
 Engraving to match Panic: Add \$150/side.

ASSA ABLOY

Experience a safer
and more open world

USA & Canada Prices Effective February 2, 2026 | Click Here for: [Canadian Tariffs](#)
 The 2026 USA Price Book Tariff Adjustment will remain at 6.25% as previously communicated.
 USA: 855 594 6989 • www.assaabloyglass.us | Canada: 800 461 3007 • www.assaabloydss.ca

Copyright © 2021-2026, ASSA ABLOY Accessories and Door Controls Group, Inc. All rights reserved. Reproduction in whole or in part without the express written permission of ASSA ABLOY Accessories and Door Controls Group, Inc. is prohibited.

Single Motion Device



Single Motion Device											
Part #	Latches	Mating Pull	Mating Handle Length	32D	US32	32D316	32316	32/32D	316E/ BSP/ WSP	4E	Opticoat
SMU9000	Up	None	None	4,032.00	4,636.00	4,435.00	5,100.00	4,233.00	5,627.00	6,190.00	7,034.00
SMU9000-3	Up	Vertical	Full	5,393.00	6,202.00	5,932.00	6,822.00	5,662.00	7,106.00	7,817.00	8,883.00
SMU9000-4	Up	Vertical	Half	5,040.00	5,796.00	5,544.00	6,376.00	5,292.00	7,034.00	7,738.00	8,793.00
SMU9000-5	Up	Vertical	Short	5,040.00	5,796.00	5,544.00	6,376.00	5,292.00	7,037.00	7,738.00	8,793.00

Single Motion Device Options: To Meet California Building Code (2013) Sec. 11B-309.4 – §111.

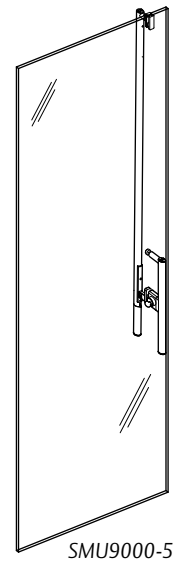
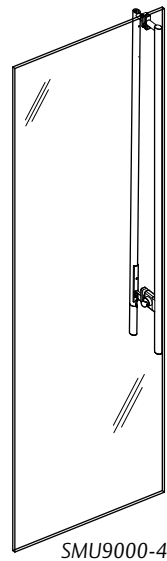
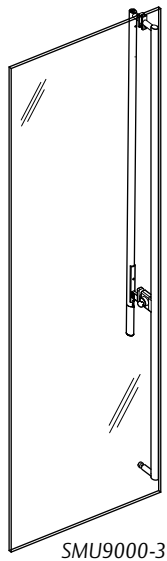
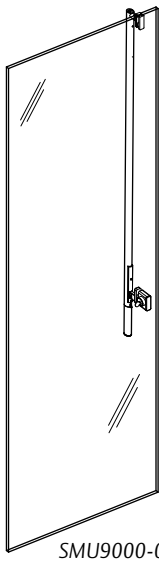

Door Controls



Floor Closers				
Part #	Description	Hold Open	Spring	Price
FC-28-90S-RH	Rixson Heavy Duty Floor Closer	90	N/A	2,212.00
FC-28-105S-RH	Rixson Heavy Duty Floor Closer	105	N/A	2,212.00
FC-28-90S-LH	Rixson Heavy Duty Floor Closer	90	N/A	2,212.00
FC-28-105S-LH	Rixson Heavy Duty Floor Closer	105	N/A	2,212.00
FC-PH28-90S-RH	Rixson Heavy Duty Floor Closer	90	5 lb. Force	2,212.00
FC-PH28-105S-RH	Rixson Heavy Duty Floor Closer	105	5 lb. Force	2,212.00
FC-PH28-90S-LH	Rixson Heavy Duty Floor Closer	90	5 lb. Force	2,212.00
FC-PH28-105S-LH	Rixson Heavy Duty Floor Closer	105	5 lb. Force	2,212.00
FC6280	Standard Duty Floor Closer	80 to 175	3 - 6	791.00
FC6275-90HO	Standard Duty Floor Closer, ADA	90	1 - 3	769.00
FC6275-105HO	Standard Duty Floor Closer, ADA	105	1 - 3	769.00
FC6275-NHO	Standard Duty Floor Closer, ADA	NHO	1 - 3	769.00

FC-28 and FC-PH28 Closers include Closer Body, Cement Case and 26D Cover Plate. Selective hold opens (S) can be turned off.
 FC-28 and FC-PH28 Cover Plates available in powder coat \$169.00 add.

ASSA ABLOY

Experience a safer
and more open world

USA & Canada Prices Effective February 2, 2026 | Click Here for: [Canadian Tariffs](#)
 The 2026 USA Price Book Tariff Adjustment will remain at 6.25% as previously communicated.
 USA: 855 594 6989 • www.assaabloyglass.us | Canada: 800 461 3007 • www.assaabloydss.ca

Copyright © 2021-2026, ASSA ABLOY Accessories and Door Controls Group, Inc. All rights reserved. Reproduction in whole or in part without the express written permission of ASSA ABLOY Accessories and Door Controls Group, Inc. is prohibited.

Floor Closers Accessories		Finish				
Part #	Description	32D/630	32/629	314E/ BSP/WSP	4E	OptiCoat™
FC-6275-CVR	Cover Plate for 6275	125.00	136.00	182.00	201.00	228.00
FC-6280-CVR	Cover Plate for 6280	125.00	136.00	182.00	201.00	228.00
Part #	Description	Style		32D/630	314E/ BSP/WSP	OptiCoat™
FC-6275/6280-ARM	Centerhung Arm for 6275 & 6280	Standard		56.00		
FC-6275/6280-OFFARM	³ / ₄ " Offset Arm for 6275 & 6280	Offset		92.00	198.00	248.00
FC-SPIND-25	Spindle ¹ / ₄ " (Use for ³ / ₈ " Clearance)	Standard		58.00		
FC-SPIND-375	Spindle ³ / ₈ " (Use for ¹ / ₂ " Clearance)	Standard		58.00		
FC-SPIND-625	Spindle ⁵ / ₈ " (Use for ³ / ₄ " Clearance)	Standard		58.00		
FC-SPIND-750	Spindle ³ / ₄ " (Use for ¹⁵ / ₁₆ " Clearance)	Standard		58.00		
FC-OFFSPIND-375	3° Offset Spindle ³ / ₈ " (Use for ¹ / ₂ " Clearance)	Offset		58.00		
FC-OFFSPIND-625	3° Offset Spindle ⁵ / ₈ " (Use for ³ / ₄ " Clearance)	Offset		58.00		
FC-OFFSPIND-750	3° Offset Spindle ³ / ₄ " (Use for ¹⁵ / ₁₆ " Clearance)	Offset		58.00		
FC-28ARM	Standard Arm for Rixson 28 Closer	Standard		208.00		
FC-28-554ARM	554 Arm for Rixson 28 Closer	Standard		208.00		

Specify handing when ordering FC-OFFSPIND.

Door Controls (cont')

Overhead Concealed Closers and Accessories				
Part #	Description	Hold Open	Spring	Price
OHC-609-90NHO	90° Back Stop, Non-Hold Open, with Mounting Clips	NHO	1-3 Adj	281.00
OHC-609-105NHO	105° Back Stop, Non-Hold Open, with Mounting Clips	NHO	1-3 Adj	281.00
OHC-609-90HO	90° Back Stop, Hold Open, with Mounting Clips	90°	1-3 Adj	281.00
OHC-609-105HO	105° Back Stop, Hold Open, with Mounting Clips	105°	1-3 Adj	281.00
OHC-304-90NHO	Heavy Duty - 90° Back Stop, Non-Hold Open, with Mounting Clips	NHO	4	330.00
OHC-304-105NHO	Heavy Duty - 105° Back Stop, Non-Hold Open, with Mounting Clips	NHO	4	330.00
OHC-304-90HO	Heavy Duty - 90° Back Stop, Hold Open, with Mounting Clips	90°	4	330.00
OHC-304-105HO	Heavy Duty - 105° Back Stop, Hold Open, with Mounting Clips	105°	4	330.00
OHC-609-MC	Slotted Mounting Clips Compatible with OHC-609 and OHC-304			14.40
OHC-609-ARM	End Load Overhead Closer Arm Compatible with OHC-609 and OHC-304			57.00

Use an auxiliary stop with OHC-304 and OHC-609.

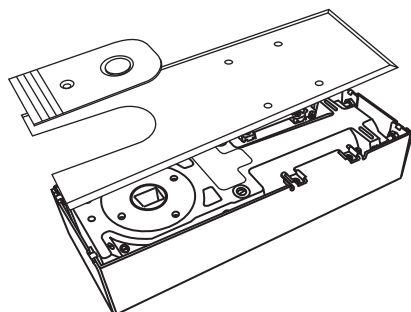

Standard Duty Floor Closer
(FC-6275)

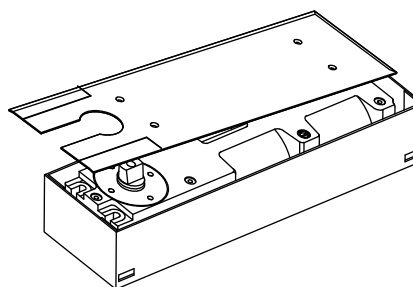

Standard Duty Floor Closer
(FC-6280)

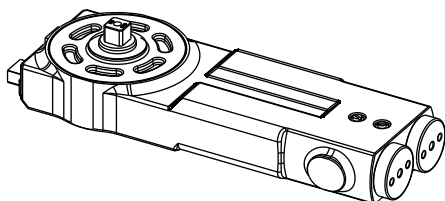

Heavy Duty Overhead Closer
(OHC-304)

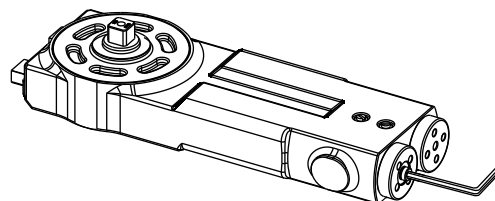

Overhead Closer
(OHC-609)

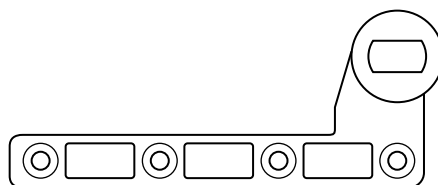

Floor Closer Offset Arm
(FC-6275/6280-OFFARM)



Floor Closer Arm
(FC-6275/6280-ARM)

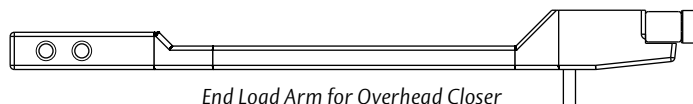

End Load Arm for Overhead Closer
(OHC-609-ARM)

ASSA ABLOY

Experience a safer
and more open world

USA & Canada Prices Effective February 2, 2026 | Click Here for: [Canadian Tariffs](#)
The 2026 USA Price Book Tariff Adjustment will remain at 6.25% as previously communicated.
USA: 855 594 6989 • www.assaabloyglass.us | Canada: 800 461 3007 • www.assaabloydss.ca

Copyright © 2021-2026, ASSA ABLOY Accessories and Door Controls Group, Inc. All rights reserved. Reproduction in whole or in part without the express written permission of ASSA ABLOY Accessories and Door Controls Group, Inc. is prohibited.

Hydraulic Door Controls

Hydraulic Patch Fitting				Finish				
Part # (Add Finish)	Description	Glass Sizes	Hold Open	32D/630	32/629	314E BSP/WSP	4E	OptiCoat™
PFD-HYD90HO	Hydraulic Patch Fitting	A, B	90	255.00	262.00	272.00	300.00	341.00
PFD-HYD105HO	Hydraulic Patch Fitting	A, B	105	255.00	262.00	272.00	300.00	341.00
PFD-HYDNHO	Hydraulic Patch Fitting	A, B	NHO	255.00	262.00	272.00	300.00	341.00

Hydraulic Hinges (Specify Handing)				Finish
Part # (Add Finish)	Description	Mounting	Glass Sizes	32D/630
HYD-HINGE	Hydraulic Hinge	Glass to Glass	A-G	1,913.00
HYD-HINGE	Hydraulic Hinge	Glass to Wall	A-G	1,639.00
HYD-HINGE-ADA	ADA Hydraulic Hinge	Glass to Glass	A-G	1,913.00
HYD-HINGE-ADA	ADA Hydraulic Hinge	Glass to Wall	A-G	1,639.00

*Sold in sets.
Order form available.

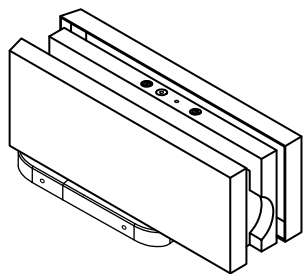

Hydraulic Patch Fitting (PFD-
HYD90HO)

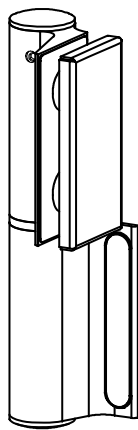

Hydraulic Hinge
(Glass to Wall)

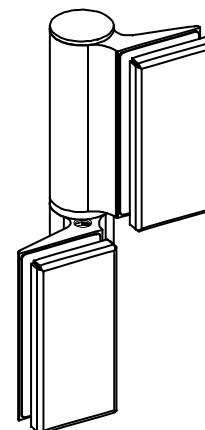

Hydraulic Hinge
(Glass to Glass)

Door Controls (cont')

Pivots		Clearance		Finish						
Part # (Add Finish)	Description	Min	Max	32D/ 630	32/ 629	28/ 628	314	314E BSP/WSP	4E	OptiCoat™
PV-WALKBEAM	Walking Beam Pivot	1/8"	3/8"	71.00	81.00	71.00	81.00	89.00	98.00	111.00
PF-FM-PIVOT	Floor Mount Pivot	7/16"	N/A	51.00						
PF-SM-PIVOT	Surface Mount Pivot	1/8"	1/4"	41.60				57.00	63.00	71.00
PF-ADJ-PIVOT	Adjustable Pivot for Patch Fitting	5/16"	5/8"	107.00	122.00	105.00	111.00	127.00	140.00	159.00
PV-ENDLOAD	Adjustable End Load Bottom Pivot	3/8"	3/4"	70.00				Satin AL Finish		
PV-300ENDLOAD	300 lb. End Load Bottom Pivot	5/16"	N/A	113.00				130.00	143.00	163.00
Part # (Add Finish)	Description	Min	Max	26D/ 626	26/625			314E/BSP/WSP	4E	OptiCoat™
PV-340	Rixson Walking Beam Pivot	1/8"	1/4"	218.00	252.00			251.00	275.00	313.00
PV-H340	Heavy Duty Walking Beam Pivot	1/8"	1/4"	711.00				745.00	817.00	930.00
PV-EH340	Electrified Walking Beam Pivot	1/8"	1/4"	1,242.00				1,304.00	1,434.00	1,527.00
PV-345	Extended Pin Walking Beam Pivot	1/8"	3/8"	711.00				745.00	817.00	930.00
PV-H345	Heavy Duty Extended Pin Walking Beam Pivot	1/8"	3/8"	1,230.00				1,273.00	1,402.00	1,592.00
PV-180	Top Offset Pivot	1/8"	3/16"	333.00				366.00	403.00	457.00

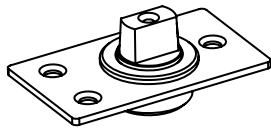

Floor Mount Pivot
(PF-FM-PIVOT)

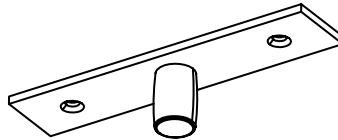

Surface Mount Pivot
(PF-SM-PIVOT)

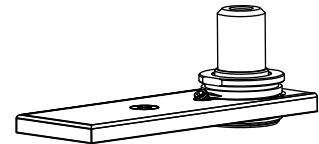

Adjustable Pivot
(PF-ADJ-PIVOT)

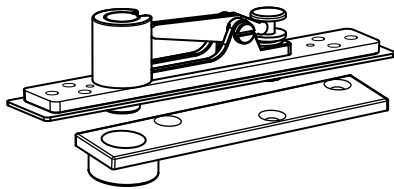

Walking Beam Pivot
(PV-WALKBEAM)

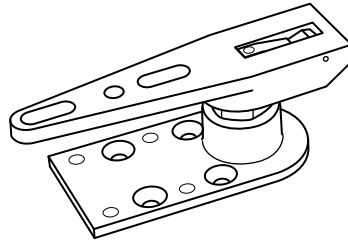

Adjustable End Load Bottom Pivot
(PV-ENDLOAD)

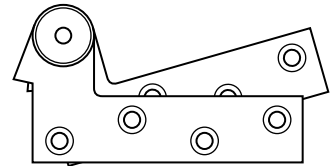

Top Offset Pivot
(PV-180)

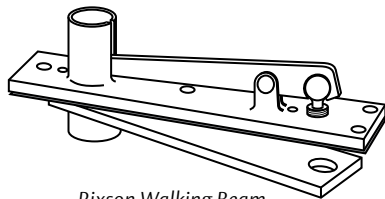

Rixson Walking Beam
Pivot (PV-340)

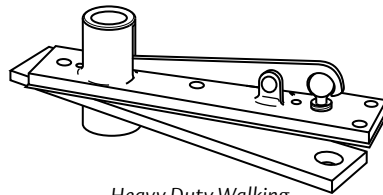

Heavy Duty Walking
Beam Pivot (PV-H340)

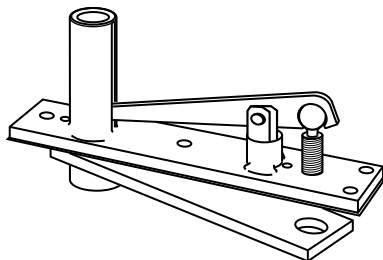

Extended Pin Walking
Beam Pivot (PV-345)

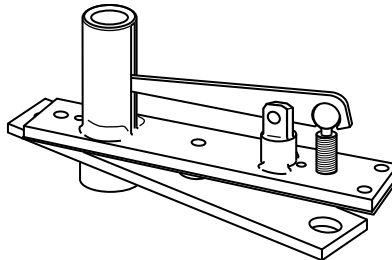

Heavy Duty Extended Pin Walking
Beam Pivot (PV-H345)

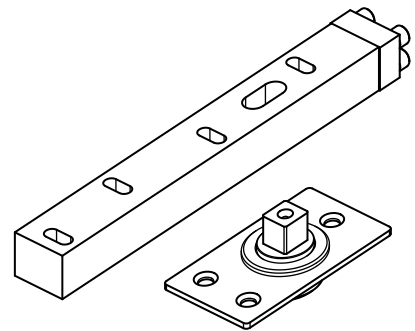

300 lb. End Load Bottom Pivot
(PV-300ENDLOAD)

ASSA ABLOY

Experience a safer
and more open world

USA & Canada Prices Effective February 2, 2026 | Click Here for: [Canadian Tariffs](#)

The 2026 USA Price Book Tariff Adjustment will remain at 6.25% as previously communicated.

USA: 855 594 6989 • www.assaabloyglass.us | Canada: 800 461 3007 • www.assaabloydss.ca

Copyright © 2021-2026, ASSA ABLOY Accessories and Door Controls Group, Inc. All rights reserved. Reproduction in whole or in part without the express written permission of ASSA ABLOY Accessories and Door Controls Group, Inc. is prohibited.

Sliding Door Hardware



Sliding Hardware - Wall Mount				Finish			
Part # (Add Finish)	Track Length	Door Width	Max Weight	32D/630	32/629	314E/BSP/WSP	4E
STS-G60x36/42	90"	36" - 42"	198 lbs	1,005.00	1,101.00	1,282.00	1,410.00
STS-G60x42/48	102"	42" - 48"	198 lbs	1,014.00	1,112.00	1,296.00	1,425.00
STS-G70x36/42	90"	36" - 42"	240 lbs	1,159.00	1,267.00	1,480.00	1,629.00
STS-G70x42/48	102"	42" - 48"	240 lbs	1,178.00	1,275.00	1,504.00	1,655.00
STS-SPLICEROD	Used for Pairs of Doors			114.00	128.00	137.00	151.00
Custom Length, Cut to Size Track				80.00			
Track Over 102" - Add Per Inch				6.50			

Sliding Hardware - Glass Mount				Finish			
Part # (Add Finish)	Door Width	Max Weight	Mounting	32D/630	32/629	314E/BSP/WSP	4E
STS-G60	28" - 38.5"	198 lbs	Glass	1,727.00	1,933.00	2,211.00	2,432.00
STS-G60	38.625" - 43"	198 lbs	Glass	1,764.00	1,976.00	2,261.00	2,487.00
STS-G60	43.125" - 49.375"	198 lbs	Glass	1,802.00	2,019.00	2,309.00	2,541.00
STS-G60	49.5" - 56"	198 lbs	Glass	1,841.00	2,061.00	2,359.00	2,594.00
STS-G70	28" - 38.5"	240 lbs	Glass	1,985.00	2,224.00	2,543.00	2,797.00
STS-G70	38.625" - 43"	240 lbs	Glass	2,029.00	2,272.00	2,598.00	2,858.00
STS-G70	43.125" - 49.375"	240 lbs	Glass	2,074.00	2,322.00	2,655.00	2,921.00
STS-G70	49.5" - 56"	240 lbs	Glass	2,117.00	2,372.00	2,711.00	2,983.00
Custom Length, Cut to Size Track				80.00			
Track Over 102" - Add Per Inch				6.50			

SGS Sliding Track				Finish			
Part #	Track Length	Mounting	Max Weight	32D/630	28/628	314E/BSP/WSP	OptiCoat™
SGS	158"	Ceiling or Wall	Soft Close - Up to 198 lbs No Soft Close - Up to 330 lbs	1,343.00	1,128.00	1,429.00	1,787.00
SGS-SL*	158"	Ceiling or Wall w/Sidelite	Soft Close - Up to 198 lbs No Soft Close - Up to 330 lbs	1,949.00	1,738.00	2,005.00	2,506.00
Add on Per Softclose				125.00	Mill Finish		

Order form available.

*2-piece u-channel and gasketing included for sidelite option.

Track length for OptiCoat™ finish is 140" max.

USA & Canada Prices Effective February 2, 2026 | Click Here for: [Canadian Tariffs](#)
 The 2026 USA Price Book Tariff Adjustment will remain at 6.25% as previously communicated.
 USA: 855 594 6989 • www.assaabloyglass.us | Canada: 800 461 3007 • www.assaabloydss.ca

Copyright © 2021-2026, ASSA ABLOY Accessories and Door Controls Group, Inc. All rights reserved. Reproduction in whole or in part without the express written permission of ASSA ABLOY Accessories and Door Controls Group, Inc. is prohibited.

ASSA ABLOY

Experience a safer
and more open world

Door Pulls



MezzoTek - Stepped Post Pulls — Straight - Flat Ends			Finish				
Part # (Add Finish)	Overall Length	Dia.	32D/630	32/629	314E/BSP/WSP	4E	OptiCoat™
RM2110	48"	1 1/4"	495.00	554.00	660.00	726.00	825.00
	96"	1 1/4"	681.00	764.00	895.00	984.00	1,119.00

MegaTek - Post Mount Pulls — Straight - Flat Ends			Finish						
Part # (Add Finish)	Overall Length	Dia.	32D/630	32/629	28/628	314	314E/BSP/WSP	4E	OptiCoat™
RM3301	48"	1 1/4"	327.00	363.00	383.00	445.00	482.00	530.00	603.00
	96"	1 1/4"	455.00	508.00	541.00	598.00	629.00	692.00	786.00

NeoMax - Post Mount Pulls — Straight - Flat Ends			Finish			
Part # (Add Finish)	Overall Length	Dia.	32/629		OptiCoat™	
RM3401	48"	1 1/4"	452.00		570.00	
	96"	1 1/4"	698.00		881.00	

English Bridle Leather Pulls — Straight - Flat Ends			Finish				
Part # (Add Finish)	Overall Length	Dia.	32D/630	32/629	314E/BSP/WSP	4E	OptiCoat™
RM6061	48"	1 1/4"	2,222.00	2,490.00	2,600.00	2,860.00	3,250.00
	96"	1 1/4"	3,116.00	3,492.00	3,578.00	3,936.00	4,473.00

Flush Leather Pulls — Straight - Flat Ends			Finish				
Part # (Add Finish)	Overall Length	Dia.	32D/630	32/629	314E/BSP/WSP	4E	OptiCoat™
RM6310	48"	1 1/4"	2,330.00	2,610.00	2,717.00	2,988.00	3,396.00
	96"	1 1/4"	4,170.00	4,673.00	4,732.00	5,205.00	5,915.00

See Rockwood Architectural Door Pull catalog for more options. Additional overall lengths available, see Architectural Price Book for pricing. Use Architectural Price Book multiplier for prices on this page.

Straight Solid Door Pulls			Finish						
Part # (Add Finish)	CTC	Dia.	32D/630	32/639	28/628	314	314E/BSP/WSP	4E	OptiCoat™
111	10"	1"	85.00	103.00	49.90	61.00	176.00	195.00	220.00
112	12"	1"	96.00	113.00	52.00	64.00	202.00	223.00	253.00
118	18"	1"	178.00	211.00	91.00	100.00	268.00	295.00	335.00

Straight Solid Single Bar Sets			Finish						
Part #	CTC	Dia.	32D/630	32/639	28/628	314	314E/BSP/WSP	4E	OptiCoat™
11147	10"	1"	309.00	358.00	155.00	178.00	630.00	692.00	801.00
11247	12"	1"	315.00	368.00	158.00	179.00	651.00	715.00	883.00
11847	18"	1"	515.00	567.00	218.00	262.00	717.00	774.00	888.00

Use Accessories Price Book multiplier for prices on this page.

ASSA ABLOY

Experience a safer
and more open world

USA & Canada Prices Effective February 2, 2026 | Click Here for: [Canadian Tariffs](#)
The 2026 USA Price Book Tariff Adjustment will remain at 6.25% as previously communicated.
USA: 855 594 6989 • www.assaabloyglass.us | Canada: 800 461 3007 • www.assaabloydss.ca

Copyright © 2021-2026, ASSA ABLOY Accessories and Door Controls Group, Inc. All rights reserved. Reproduction in whole or in part without the express written permission of ASSA ABLOY Accessories and Door Controls Group, Inc. is prohibited.

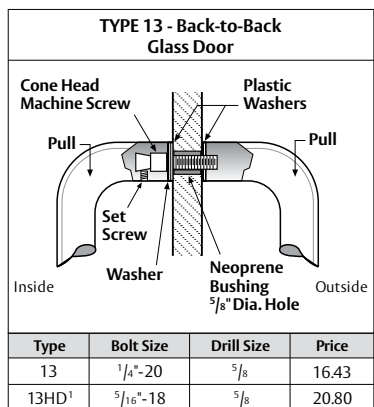

¹13HD mounting features 2 set screws 180 degrees apart.

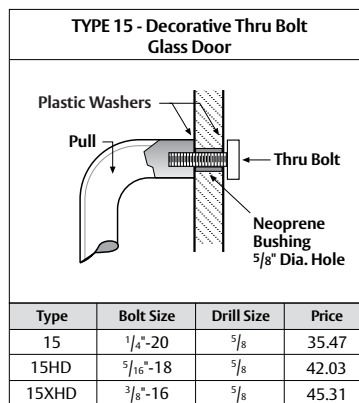

Quick Ship MegaTek - Straight PostMount Pulls

Straight Pulls - Flat Ends - Back-to-Back Mounting				Finish	
Part # (Add Finish)	CTC	OA	Dia.	32D/630	BSP
RM3301BTB1224.32D	12"	24"	1 1/4"	384.00	
RM3301BTB1224.BSP	12"	24"	1 1/4"		427.00
RM3301BTB1824.32D	18"	24"	1 1/4"	384.00	
RM3301BTB1824.BSP	18"	24"	1 1/4"		427.00
RM3301BTB2436.32D	24"	36"	1 1/4"	461.00	
RM3301BTB3036.32D	30"	36"	1 1/4"	461.00	
RM3301BTB3036.BSP	30"	36"	1 1/4"		491.00
RM3301BTB3648.32D	36"	48"	1 1/4"	540.00	
RM3301BTB3648.BSP	36"	48"	1 1/4"		567.00
RM3301BTB4248.BSP	42"	48"	1 1/4"		567.00
RM3301BTB4860.32D	48"	60"	1 1/4"	588.00	
RM3301BTB4860.BSP	48"	60"	1 1/4"		597.00
RM3301BTB6072.32D	60"	72"	1 1/4"	641.00	
RM3301BTB6072.BSP	60"	72"	1 1/4"		672.00
RM3301BTB7284.32D	72"	84"	1 1/4"	692.00	
RM3301BTB8496.32D	84"	96"	1 1/4"	746.00	

Mounting included for both 1 3/4" wood or metal doors and 1/2" glass doors.

Quick Ship Half Height Locking Pulls

Part #	CTC	OA	Door Thickness	Price
LP3301DBU48.32D	39"	48"	1/2" Glass	1,221.00
LP3301DBU48.BSP	39"	48"	1/2" Glass	1,605.00
LP3301DBU60.32D	51"	60"	1/2" Glass	1,221.00
LP3301DBU60.BSP	51"	60"	1/2" Glass	1,605.00
LP3301DBD51.32D	42"	51"	1/2" Glass	1,197.00
LP3301DBD51.BSP	42"	51"	1/2" Glass	1,531.00

- DBU come with LPS12 Strikes and ADA Thumbturn.
- DBD come with 570 Dustproof Strike and ADA Thumbturn.
- 09 Cylinder standard.

USA & Canada Prices Effective February 2, 2026 | Click Here for: [Canadian Tariffs](#)
 The 2026 USA Price Book Tariff Adjustment will remain at 6.25% as previously communicated.
 USA: 855 594 6989 • www.assaabloyglass.us | Canada: 800 461 3007 • www.assaabloydss.ca

Copyright © 2021-2026, ASSA ABLOY Accessories and Door Controls Group, Inc. All rights reserved. Reproduction in whole or in part without the express written permission of ASSA ABLOY Accessories and Door Controls Group, Inc. is prohibited.

ASSA ABLOY

Experience a safer
and more open world

Mechanical Locking Hardware



Locking Door Pulls - Back to Back Set		Finish					
Post Mount - Round							
Part # (Add Finish)	Description	32D/630	32/629	314E/BSP/WSP	4E	OptiCoat™	
LP3301DBD	Half Height Pull - Bolts Down	1,275.00	1,425.00	1,922.00	2,114.00	2,402.00	
LP3301DBU	Half Height Pull - Bolts Up	1,374.00	1,539.00	2,049.00	2,255.00	2,561.00	
LP3301FHD	Full Height Pull - Bolts Down	1,471.00	1,650.00	2,171.00	2,388.00	2,714.00	
LP3301FHU	Full Height Pull - Bolts Up	1,589.00	1,780.00	2,316.00	2,547.00	2,895.00	
Post Mount - Round - Dummy Pull - Back to Back Set							
DP3301DBD	Half Height Pull - Matches Bolts Down	1,037.00	1,109.00	1,469.00	1,617.00	1,836.00	
DP3301DBU	Half Height Pull - Matches Bolts Up	1,037.00	1,109.00	1,469.00	1,617.00	1,836.00	
Horizontal Push/Pull Bar Option - Half Height – Bolts Down (DBD)							
LP3301DBDPMPB	Post Mount Both Sides	1,826.00	2,046.00	2,612.00	2,874.00	3,265.00	
Horizontal Push/Pull Bar Option - Half Height – Bolts Up (DBU)							
LP3301DBUPMPB	Post Mount Both Sides	1,826.00	2,046.00	2,612.00	2,874.00	3,265.00	
Locking Door Pull Accessories		Finish					
Part # (Add Finish)	Description	32D/630	32/629	28/628	314E/BSP/WSP	4E	OptiCoat™
LPS02	Top Strike - w/Rubber Stop - 3/4" x 2 1/2" x 3"	85.00	93.00	51.00	55.00	60.00	65.00
LPS03	Top Strike - Stainless Steel - .050" x 1 1/8" x 2 1/4"	39.00	44.00		55.00	60.00	65.00
LPS04	Transom Strike - 1 1/4" Dia. x 4 1/2"	117.00	128.00		176.00	193.00	208.00
LPS05	Transom Strike - 1 1/4" Sq. x 4 1/2"	133.00	151.00		205.00	225.00	241.00
LPS06	Mortised Header Strike - 2" Dia.	134.00	152.00		207.00	227.00	244.00
LPS07	Top Inswinging Strike	197.00	222.00		228.00	251.00	269.00
LPS12	Top Strike - w/Adjustable Stops - 3/4" x 1 1/2" x 3"	103.00	117.00		156.00	171.00	184.00
Part # (Add Finish)	Description		26D/626	26/625	314E/BSP/WSP		OptiCoat™
*570	Dust Proof Strike		23.20	29.70	48.40		60.00

Order form available. DBD and DBU priced as 51" overall. Add ⁵13/in. over 96" long for full height or 51" long for half height.

Horizontal push/pull option, add ⁵13/in over 36".

Use Architectural Price Book multiplier for prices on this page.

*Use Accessories Price Book multiplier for prices on this product.

ASSA ABLOY

Experience a safer
and more open world

USA & Canada Prices Effective February 2, 2026 | Click Here for: [Canadian Tariffs](#)
The 2026 USA Price Book Tariff Adjustment will remain at 6.25% as previously communicated.
USA: 855 594 6989 • www.assaabloyglass.us | Canada: 800 461 3007 • www.assaabloydss.ca

Copyright © 2021-2026, ASSA ABLOY Accessories and Door Controls Group, Inc. All rights reserved. Reproduction in whole or in part without the express written permission of ASSA ABLOY Accessories and Door Controls Group, Inc. is prohibited.

Locking Door Pull with Flat Latch		Finish				
		32D/630	32/629	Stock PC/ 10BE	4E	OptiCoat™
Part # (Add Finish)	Description					
FL3301DBU	Half Height Pull - Bolts Up	5,201.00	5,981.00	7,456.00	8,202.00	9,321.00
FL3301FHU	Full Height Pull - Bolts Up	5,565.00	6,400.00	7,532.00	8,286.00	9,416.00
Horizontal Push/Pull Bar Option - Half Height - Bolts Up (DBU)						
FL3301DBUBEPB	Bent End Both Sides	5,523.00	6,343.00	7,825.00	8,607.00	9,782.00
FL3301DBUBEPT	Bent End Thumbturn Side - Mating Side Vertical	5,312.00	6,105.00	7,582.00	8,340.00	9,477.00
FL3301DBUBEPC	Bent End Cylinder Side - Mating Side Vertical	5,312.00	6,105.00	7,582.00	8,340.00	9,477.00
FL3301DBUPMPB	Post Mount Both Sides	5,657.00	6,493.00	7,979.00	8,776.00	9,974.00
FL3301DBUPMPT	Post Mount Thumbturn Side - Mating Side Vertical	5,427.00	6,236.00	7,715.00	8,486.00	9,644.00
FL3301DBUPMPC	Post Mount Cylinder Side - Mating Side Vertical	5,427.00	6,236.00	7,715.00	8,486.00	9,644.00
Horizontal Push/Pull Bar Option - Full Height - Bolts Up (FHU)						
FL3301FHUBEPT	Bent End Thumbturn Side - Mating Side Vertical	5,677.00	6,524.00	7,659.00	8,425.00	9,573.00
FL3301FHUBEPC	Bent End Cylinder Side - Mating Side Vertical	5,677.00	6,524.00	7,659.00	8,425.00	9,573.00
FL3301FHUPMPT	Post Mount Thumbturn Side - Mating Side Vertical	5,792.00	6,654.00	7,792.00	8,570.00	9,740.00
FL3301FHUPMPC	Post Mount Cylinder Side - Mating Side Vertical	5,792.00	6,654.00	7,792.00	8,570.00	9,740.00

*See page 27 for strikes/stops.

Locking Door Pull with Flat Latch for Inswing		Finish				
		32D/630	32/629	Stock PC/ 10BE	4E	OptiCoat™
Part # (Add Finish)	Description					
INSFL3301DBU	Half Height Pull - Bolts Up	5,201.00	5,981.00	7,456.00	8,202.00	9,321.00
INSFL3301FHU	Full Height Pull - Bolts Up	5,565.00	6,400.00	7,532.00	8,286.00	9,416.00
Horizontal Push/Pull Bar Option - Half Height - Bolts Up (DBU)						
INSFL3301DBUBEPB	Bent End Both Sides	5,523.00	6,343.00	7,825.00	8,607.00	9,782.00
INSFL3301DBUBEPT	Bent End Thumbturn Side - Mating Side Vertical	5,312.00	6,105.00	7,582.00	8,340.00	9,477.00
INSFL3301DBUBEPC	Bent End Cylinder Side - Mating Side Vertical	5,312.00	6,105.00	7,582.00	8,340.00	9,477.00
INSFL3301DBUPMPB	Post Mount Both Sides	5,657.00	6,493.00	7,979.00	8,776.00	9,974.00
INSFL3301DBUPMPT	Post Mount Thumbturn Side - Mating Side Vertical	5,427.00	6,236.00	7,715.00	8,486.00	9,644.00
INSFL3301DBUPMPC	Post Mount Cylinder Side - Mating Side Vertical	5,427.00	6,236.00	7,715.00	8,486.00	9,644.00
Horizontal Push/Pull Bar Option - Full Height - Bolts Up (FHU)						
INSFL3301FHUBEPT	Bent End Thumbturn Side - Mating Side Vertical	5,677.00	6,524.00	7,659.00	8,425.00	9,573.00
INSFL3301FHUBEPC	Bent End Cylinder Side - Mating Side Vertical	5,677.00	6,524.00	7,659.00	8,425.00	9,573.00
INSFL3301FHUPMPT	Post Mount Thumbturn Side - Mating Side Vertical	5,792.00	6,654.00	7,792.00	8,570.00	9,740.00
INSFL3301FHUPMPC	Post Mount Cylinder Side - Mating Side Vertical	5,792.00	6,654.00	7,792.00	8,570.00	9,740.00
Inswing Flat Latch Strikes		Finish				
Part # (Add Finish)		32D/630	32/629	314E/ WSP/BSP	4E	OptiCoat™
INSFL-1600		572.00	686.00	744.00	930.00	930.00
INSFL-MSK		115.00	148.00	182.00	156.00	228.00

Order form available. DBD and DBU priced as 51" overall. Add \$13/in. over 96" long for full height or 51" long for half height.

Horizontal push/pull option, add \$13/in over 36".

Use Architectural Price Book multiplier for prices on this page.



USA & Canada Prices Effective February 2, 2026 | Click Here for: [Canadian Tariffs](#)
The 2026 USA Price Book Tariff Adjustment will remain at 6.25% as previously communicated.
USA: 855 594 6989 • www.assaabloyglass.us | Canada: 800 461 3007 • www.assaabloydss.ca

Copyright © 2021-2026, ASSA ABLOY Accessories and Door Controls Group, Inc. All rights reserved. Reproduction in whole or in part without the express written permission of ASSA ABLOY Accessories and Door Controls Group, Inc. is prohibited.

ASSA ABLOY

Experience a safer
and more open world

Mechanical Locking Hardware (cont')

Center Housing (only) Prepped for ASSA ABLOY ACCENTRA 8800 & Sargent 8200 Series Mortise Locks					Finish				
Part # (Add Finish)	Housing Prep	Size	Handing	Glass Sizes	32D/630	32/629	314E/BSP	4E	OptiCoat™
CLH-PAS	Passage	6 3/16" x 10 3/16"	N/A	B, C	361.00	415.00	500.00	551.00	625.00
CLH-ENT	Entry	6 3/16" x 10 3/16"	LH/LHR, RH/RHR	B, C	373.00	428.00	514.00	565.00	643.00
CLH-OFF	Office	6 3/16" x 10 3/16"	LH/LHR, RH/RHR	B, C	395.00	451.00	527.00	580.00	659.00
CLK-BC	Keeper for Latch	6 3/16" x 10 3/16"	N/A	B, C	358.00	413.00	487.00	535.00	608.00
CLH-PAS	Passage	6 3/16" x 10 3/16"	N/A	E, F	426.00	488.00	576.00	634.00	721.00
CLH-ENT	Entry	6 3/16" x 10 3/16"	LH/LHR, RH/RHR	E, F	440.00	505.00	591.00	650.00	738.00
CLH-OFF	Office	6 3/16" x 10 3/16"	LH/LHR, RH/RHR	E, F	454.00	519.00	607.00	668.00	759.00
CLK-EF	Keeper for Latch	6 3/16" x 10 3/16"	N/A	E, F	412.00	475.00	560.00	616.00	700.00
Add for Other ASSA ABLOY (Sargent) Mortise Lock Preps					150.00	150.00	150.00	150.00	188.00
Add for Competitor Mortise Lock Preps*					200.00	200.00	200.00	200.00	200.00

*Must have factory approval - pricing may vary.

Centerlock Keeper with Electric Strike					Finish				
Part # (Add Finish)	Description	Size	Handing	Glass Size	32D/630	32/629	314E/BSP	4E	OptiCoat™
CLK-ESK-1600	Centerlock Keeper w/1600 Strike	6 3/16" x 10 3/16"	N/A	B, C	2,677.00	2,998.00	3,219.00	3,541.00	4,024.00
CLK-ESK-1600	Centerlock Keeper w/1600 Strike	6 3/16" x 10 3/16"	N/A	E, F	3,078.00	3,449.00	3,701.00	4,072.00	4,627.00
*CLK-ESK-ES100-16	Centerlock Keeper w/ES100-16 Strike	6 3/16" x 10 3/16"	LH/RH, LHR/RHR	B, C	3,118.00	3,492.00	3,742.00	4,116.00	4,678.00
*CLK-ESK-ES100-16	Centerlock Keeper w/ES100-16 Strike	6 3/16" x 10 3/16"	LH/RH, LHR/RHR	E, F	3,586.00	4,016.00	4,304.00	4,733.00	5,380.00
LM	Lock Monitor				191.00				

Works in conjunction with ASSA ABLOY ACCENTRA 8800 Series Mortise Lock.

*Requires Aperio Certified Integrator Certification by Others.

Centerlock Housing (only) Prepped for Sargent IN Series					Finish				
Part # (Add Finish)	Description	Size	Handing	Glass Size	32D/630	32/629	314E/BSP	4E	OptiCoat™
CLH-IN	Centerlock Housing for Sargent IN Series	6 3/16" x 15 3/16"	LH/LHR, RH/RHR	B, C	1,841.00	2,061.00	2,116.00	2,329.00	2,646.00
CLK-IN	Centerlock Keeper	6 3/16" x 15 3/16"	N/A	B, C	988.00	1,107.00	1,273.00	1,400.00	1,591.00



ASSA ABLOY

Experience a safer
and more open world

USA & Canada Prices Effective February 2, 2026 | Click Here for: [Canadian Tariffs](#)
The 2026 USA Price Book Tariff Adjustment will remain at 6.25% as previously communicated.
USA: 855 594 6989 • www.assaabloyglass.us | Canada: 800 461 3007 • www.assaabloydss.ca

Copyright © 2021-2026, ASSA ABLOY Accessories and Door Controls Group, Inc. All rights reserved. Reproduction in whole or in part without the express written permission of ASSA ABLOY Accessories and Door Controls Group, Inc. is prohibited.

Mortise Cylinders						Finish		
Part # (Add Finish)	Keyway	Cam	Cyl Length	Pins	Keyed	15/619	14/618	BSP
MC-PARA-250-KR	Para	2160	1 1/8"	6	Random	126.00	135.00	161.00
MC-SCHL-250-KR	Schlage C	2160	1 1/8"	6	Random	121.00		161.00
MC-SFIC-A620	Best	2160	1 3/8"	7	Random	197.00	210.00	240.00

ASSA ABLOY ACCENTRA 8801 Passage Mortise Locks					Finish		
Part # (Add Finish)	Lock Function	Lever Style	Rose		15/619	14/618	BSP
ML-PAS-AUR3	Passage	AU	R3		911.00	1,046.00	1,187.00
ML-PAS-CRR3	Passage	CR	R3		911.00	1,046.00	1,187.00
ML-PAS-JNR3	Passage	JN	R3		1,033.00	1,188.00	1,348.00

ASSA ABLOY ACCENTRA 8807 Entry Mortise Locks (Less Cylinder)					Finish		
Part # (Add Finish)	Lock Function	Lever Style	Rose		15/619	14/618	BSP
ML-ENT-AUR3-LC	Entry	AU	R3		1,048.00	1,206.00	1,368.00
ML-ENT-CRR3-LC	Entry	CR	R3		1,048.00	1,206.00	1,368.00
ML-ENT-JNR3-LC	Entry	JN	R3		1,171.00	1,347.00	1,527.00

ASSA ABLOY ACCENTRA 8809 Office Mortise Locks (Less Cylinder)					Finish		
Part # (Add Finish)	Lock Function	Lever Style	Rose		15/619	14/618	BSP
ML-OFF-AUR3-LC	Office	AU	R3		1,059.00	1,216.00	1,387.00
ML-OFF-CRR3-LC	Office	CR	R3		1,059.00	1,216.00	1,387.00
ML-OFF-JNR3-LC	Office	JN	R3		1,181.00	1,357.00	1,548.00

Other locks available upon request.

NOTE: BSP is not a stocked product and extended lead time will apply.



AU



CR



JN

Mechanical Locking Hardware (cont')

Center Housing (only) Prepped for Cylindrical Locks				Finish			
Part # (Add Finish)	Size	Glass Sizes	32D/630	32/629	314E/BSP	4E	OptiCoat™
CLH-CL	6 ³ / ₁₆ " x 6 ³ / ₁₆ "	B, C	464.00	519.00	566.00	622.00	707.00
CLK-CL	6 ³ / ₁₆ " x 6 ³ / ₁₆ "	B, C	373.00	418.00	456.00	500.00	570.00

ASSA ABLOY ACCENTRA 4600LN Series Cylindrical Locks				Finish		
Part # (Add Finish)	Lock Function	Lever Style	Cylinder	26D/626	26/626	BSP
CL-PAS-AU	Passage	AU		170.00	190.00	178.00
CL-ENT/OFF-AU	Office/Entry	AU	7 Pin SFIC	192.00	215.00	202.00

Centerlock Housing (only) Prepped for Centrios and Accentra Cylindrical Locks				Finish				
Part # (Add Finish)	Size	Handing	Glass Sizes	32D/630	32/629	314E/BSP	4E	OptiCoat™
CLH-CLE	6 ³ / ₁₆ " x 10 ³ / ₁₆ "	N/A	B, C	880.00	986.00	1,056.00	1,267.00	1,320.00
CLK-CLE	6 ³ / ₁₆ " x 10 ³ / ₁₆ "	N/A	B, C	344.00	397.00	468.00	514.00	585.00

ASSA ABLOY ACCENTRA nexTouch Cylindrical Keypad Lock				Finish		
Part # (Add Finish)	Description	Lever Style		26D/626	BSP	
CL-NTB623-AU	NexTouch Touchscreen w/ Cylinder Override	AU		1,173.00	1,173.00	

*Pairs with CLH-CLE.

Deadbolt Locks				Finish					
Part # (Add Finish)	Description	Size	Glass Sizes	32D/630	32/629	28/628	314E/BSP/WSP	4E	OptiCoat™
PF-DBLOCK-BC	Deadbolt	2 ⁵ / ₈ " x 6"	B, C	236.00	271.00	163.00	232.00	262.00	290.00
PF-DBSTRIKE-BC	Strike for Deadbolt	2 ⁵ / ₈ " x 6"	B, C	194.00	223.00	137.00	187.00	215.00	234.00
PFD-LOCKCYL	1" Cylinder w/Collar			28.90	28.90	28.90	48.00	53.00	60.00
PFD-LOCKTT	1" Thumbturn w/Collar			28.90	28.90	28.90	48.00	53.00	60.00

Lever Lock Set				Finish		
Part # (Add Finish)	Description	Size	Glass Sizes	32D/630	314E/BSP/WSP	OptiCoat™
PF-LSLOCK	Lever Lock	3 ¹ / ₄ " x 6 ³ / ₈ "	A, B	255.00	307.00	384.00
PF-LSKEEPER	Keeper for Lever Lock	3 ¹ / ₄ " x 6 ³ / ₈ "	A, B	99.00	119.00	149.00



ASSA ABLOY

Experience a safer
and more open world

USA & Canada Prices Effective February 2, 2026 | Click Here for: [Canadian Tariffs](#)
The 2026 USA Price Book Tariff Adjustment will remain at 6.25% as previously communicated.
USA: 855 594 6989 • www.assaabloyglass.us | Canada: 800 461 3007 • www.assaabloydss.ca

Copyright © 2021-2026, ASSA ABLOY Accessories and Door Controls Group, Inc. All rights reserved. Reproduction in whole or in part without the express written permission of ASSA ABLOY Accessories and Door Controls Group, Inc. is prohibited.

Electrified Hardware



Digital Door Lock		Finish
Part # (Add Finish)	Description	BLK
DL-GS3550	Digital Door Lock	840.00

Concealed Magnetic Locks		Finish
Part # (Add Finish)	Description	32D/630
MAG-SAMBD	Shear Magnalock w/MBS/DPS - 12/24VDC, Self Aligning	1,440.00
MAG-SAM2-24VDC	Shear Magnalock - 24VDC, Mini Version	987.00

M32 Magnalock		Finish			
Part # (Add Finish)	Description	32D/630	32/629	28/628	314E/BSP
*MAG-M32BD	M32 Magnalock - 600 lbs, 12/24VDC	720.00	Base Unit		
MAG-DC32	Dress Covers - M32		159.00	63.00	166.00

M380E/M680E Magnalock		Finish		
Part # (Add Finish)	Description	32D/630	28/628	BSP
**MAG-M380EBDX	M380E EcoMag Magnalock - 600 lbs, 12/24VDC	1,197.00	1,034.00	1,106.00
MAG-M680EBDX	M680E EcoMag Magnalock - 1200 lbs, 12/24VDC	1,404.00	1,269.00	1,337.00

USA & Canada Prices Effective February 2, 2026 | Click Here for: [Canadian Tariffs](#)
 The 2026 USA Price Book Tariff Adjustment will remain at 6.25% as previously communicated.
 USA: 855 594 6989 • www.assaabloyglass.us | Canada: 800 461 3007 • www.assaabloydss.ca

Copyright © 2021-2026, ASSA ABLOY Accessories and Door Controls Group, Inc. All rights reserved. Reproduction in whole or in part without the express written permission of ASSA ABLOY Accessories and Door Controls Group, Inc. is prohibited.

ASSA ABLOY

Experience a safer
and more open world

Electrified Hardware (cont')

Alarm Controls Magnetic Locks		Finish	
Part # (Add Finish)	Description	28/628	314E/BSP/WSP
*MAG-600LB	Alarm Controls Mag Lock w/ Sensor - 600 lbs Single	391.00	
*MAG-600DLB	Alarm Controls Mag Lock w/ Sensor - 600 lbs Double	559.00	
MAG-1200LB	Alarm Controls Mag Lock w/ Sensor - 1200 lbs Single	503.00	
MAG-1200DLB	Alarm Controls Mag Lock w/ Sensor - 1200 lbs Double	693.00	
MAG-AM3325	Adjustable Mounting Bracket for Alarm Controls - 600 lbs Single	80.00	190.00
MAG-AM3326	Mounting Bracket for Alarm Controls - 600 lbs Double	109.00	218.00
MAG-AM6325	Adjustable Mounting Bracket for Alarm Controls - 1200 lbs Single	110.00	219.00
MAG-AM6326	Mounting Bracket for Alarm Controls - 1200 lbs Double	115.00	225.00
MAG-GDH	Glass Door Holder for Alarm Controls Mag Lock	90.00	199.00

*Compatible with 2³/₄" rails.

**Not compatible with patch fitting doors.

Electrified Hardware Accessories		Finish					
Part # (Add Finish)	Description	32D/630	28/628	314E/BSP/WSP	BK	White	OptiCoat™
MAG-UHB-8	Universal Header Bracket 1" x 1 1/2" x 8"		108.00	217.00			267.00
MAG-UHB-12	Universal Header Bracket 1" x 1 1/2" x 12"		155.00	264.00			323.00
MAG-HEB-1-8	Header Extension Bracket 1" x 1", 8" Long		61.00	170.00			209.00
MAG-HEB-1-12	Header Extension Bracket 1" x 1", 12" Long		66.00	175.00			215.00
MAG-HEB-2-8	Header Extension Bracket 2" x 2", 8" Long		79.00	188.00			231.00
MAG-HEB-2-12	Header Extension Bracket 2" x 2", 12" Long		87.00	196.00			240.00
MAG-GDB	Glass Door Bracket		100.00	209.00			249.00
MAG-AKG	Adhesive Kit for GDB		236.00				
MAG-GDB-M680	Glass Door Bracket for MAG-M680	114.00		237.00			
MAG-XMS2	Motion Sensor					318.00	
MAG-SREX-100	Motion Sensor				318.00		
MAG-EEB2	Emergency Exit Button	201.00					
MAG-EEB3N	Narrow Emergency Exit Button	201.00					

Card Readers		Finish	
Part # (Add Finish)	Description	Black	28/628
RD-R100H-IPS	R100, iCLASS SE, Wireless Reader w/ Paired Hub	1,043.00	
RD-R100-DPK	R100 Dress Plate Kit		39.40

Power Supplies		Finish
Part # (Add Finish)	Description	Beige
PS-AQD2-4C1	2 Amp, Dual Voltage, 4 Output, 1A PTC	370.00
PS-AQD4-8F8R2	4 Amp, Dual Voltage, 8 Relayed Outputs, 2A Glass Fuse	535.00
PS-AQD6-8F8R2	6 Amp, Dual Voltage, 8 Relayed Outputs, 2A Glass Fuse	608.00

ASSA ABLOY

Experience a safer
and more open world

USA & Canada Prices Effective February 2, 2026 | Click Here for: [Canadian Tariffs](#)
The 2026 USA Price Book Tariff Adjustment will remain at 6.25% as previously communicated.
USA: 855 594 6989 • www.assaabloyglass.us | Canada: 800 461 3007 • www.assaabloydss.ca

Copyright © 2021-2026, ASSA ABLOY Accessories and Door Controls Group, Inc. All rights reserved. Reproduction in whole or in part without the express written permission of ASSA ABLOY Accessories and Door Controls Group, Inc. is prohibited.

Cladding

Door Rail Cladding Only (24" to 48") (Price Per Piece)			Finish						
Part # (Add Finish)	Profile	Rail Height	32D/630	32/629	28/628	314	314E/BSP/WSP	4E	OptiCoat™
DRS-275-CL	Square	2 3/4"	51.00	58.00			52.00	55.00	69.00
DRT-275-CL	Tapered	2 3/4"	51.00	58.00			52.00	55.00	69.00
DRS-4-CL	Square	4"	60.00	73.00			62.00	66.00	82.00
DRT-4-CL	Tapered	4"	60.00	73.00			62.00	66.00	82.00
DRS-6-CL	Square	6"	76.00	86.00			77.00	81.00	102.00
DRS-10-CL	Square	10"	160.00	186.00	127.00	140.00	172.00	172.00	214.00

Rail Cladding Preps		Price
Cylinder / Pull / Panic Hole		25.00
Offset Pivot		40.00
Stop / Holder or Arm Closer		100.00

Sidelite Rail Cladding Only (Price Per Piece, Per Foot)			Finish						
Part # (Add Finish)	Profile	Rail Height	32D/630	32/629	28/628	314	314E/BSP/WSP	4E	OptiCoat™
SRS-275-CL	Square	2 3/4"	25.10	28.80			25.30	26.90	33.70
SRT-275-CL	Tapered	2 3/4"	25.10	28.80			25.30	26.90	33.70
SRS-4-CL	Square	4"	30.30	34.70			30.50	32.40	40.60
SRT-4-CL	Tapered	4"	30.30	34.70			30.50	32.40	40.60
SRS-6-CL	Square	6"	36.80	42.30			37.10	39.50	49.40
SRS-10-CL	Square	10"	81.00	93.00	61.00	68.00	87.00	87.00	109.00

U-Channel Cladding Only (Price Per Piece, Per Foot)			Finish			
Part # (Add Finish)	Channel Height	Channel Width	32D/630	32/629	4E	OptiCoat™
UC-0687x1625-CL	1 11/16"	1 5/8"	9.60	11.10	10.40	13.00
UC-1625x1625-CL	1 5/8"	1 5/8"	16.00	18.30	17.20	21.40
UC-1625x1875-CL	1 5/8"	1 7/8"	19.20	22.00	20.60	25.80

Header Cladding Only (Price Per Piece, Per Foot)			Finish					
Part # (Add Finish)	Header Type	Notes	32D/630	32/629	314E/BSP/WSP	4E	OptiCoat™	
HD-1750xSIDE-CL	Sides	2 Pieces	12.90	14.80	13.00	13.80	17.30	
HD-4000-BINS-CL	Blank Ins	1 Piece	12.90	14.80	13.00	13.80	17.30	
HD-4000-PINS-CL	Pocket Ins	2 Pieces	12.90	14.80	13.00	13.80	17.30	
HD-4500-BINS-CL	Blank Ins	1 Piece	12.90	14.80	13.00	13.80	17.30	
HD-4500-PINS-CL	Pocket Ins	2 Pieces	12.90	14.80	13.00	13.80	17.30	
HDS-1750x4000-CL	Solid	3 Pieces	28.90	33.40	29.05	31.00	38.70	
HDS-1750x4500-CL	Solid	3 Pieces	28.90	33.40	29.05	31.00	38.70	
HDS-2000x2000-CL	Solid	3 Pieces	22.50	25.90	22.70	24.10	30.20	
HDS-2000x6000-CL	Solid	3 Pieces	29.00	33.40	29.20	31.10	38.90	

Header Cover Plates Only			Finish						
Part # (Add Finish)	Header Type	Length	32D/630	32/629	28/628	314	314E/BSP/WSP	4E	OptiCoat™
HDR-CVRPLT*	2-Piece Header Cover Plate		60.00	82.00	17.00	29.00	54.00	73.00	68.00
HDS-CVRPLT*	Solid Header Cover Plate		72.00	94.00	28.00	40.00	64.00	84.00	81.00
HDF-CVRPLT*	Floating Header Cover Plate		82.00	94.00	71.00	81.00	86.00	105.00	108.00
HDR-CVRPLT-BLK	1750x4000 Pocket	Per Foot**	25.00	28.00	17.20	18.50	28.50	31.00	36.00
HDR-CVRPLT-BLK	1750x4500 Pocket	Per Foot**	28.50	34.50	18.90	21.90	31.50	35.00	39.50
HDR-CVRPLT-BLK	1750x4000/4500 Flat	Per Foot**	17.40	17.60	10.80	11.40	20.30	22.00	25.50

*Add in Coverplate Prep.
 **Pricing starts at 36".

Header Cladding and Coverplate Preps		Price
Pivot		60.00
Standard OHC		60.00
Offset Pivot		60.00
Panic Manual Strike		50.00
Panic Electric Strike		75.00

Vertical Stile Cladding (Price Per Foot)			Finish						
Part # (Add Finish)	Notes	Glass Size	32D/630	32/629	28/628	314	314E/BSP/WSP	4E	OptiCoat™
DRVS-CL	2 Pieces (set)	B, C	29.50	32.90	28.20	25.20	32.40	38.80	44.70
DRVS-CL	2 Pieces (set)	F	37.20	41.60	35.40	40.70	44.10	48.50	55.10

USA & Canada Prices Effective February 2, 2026 | Click Here for: [Canadian Tariffs](#)
 The 2026 USA Price Book Tariff Adjustment will remain at 6.25% as previously communicated.
 USA: 855 594 6989 • www.assaabloyglass.us | Canada: 800 461 3007 • www.assaabloydss.ca

Copyright © 2021-2026, ASSA ABLOY Accessories and Door Controls Group, Inc. All rights reserved. Reproduction in whole or in part without the express written permission of ASSA ABLOY Accessories and Door Controls Group, Inc. is prohibited.

ASSA ABLOY

Experience a safer
and more open world

End Caps

Door Rail End Caps Only			Finish						
Part # (Add Finish)	Profile	Height	32D/630	32/629	28/628	314	314E/BSP/WSP	4E	OptiCoat™
ECDS-275AC	Square	2 3/4"	42.10	49.30	22.80	24.20	31.00	45.70	38.80
ECDS-4AC	Square	4"	31.20	40.90	16.60	19.00	24.80	33.90	31.00
ECDT-4AC	Tapered	4"	31.20	40.90	16.60	19.00	24.80	33.90	31.00
ECDS-6AC	Square	6"	76.00	85.00	73.00	79.00	88.00	82.00	110.00
ECDS-10AC	Square	10"	102.00	120.00	88.00	100.00	108.00	111.00	135.00
ECDT-275BD	Tapered	2 3/4"	53.00	60.00	36.80	39.40	45.90	57.00	57.00
ECDS-4DF	Square	4"	43.30	51.00	29.20	33.00	38.40	46.90	47.90
ECDT-4DF	Tapered	4"	43.30	51.00	29.20	33.00	38.40	46.90	47.90
ECDS-6DF	Square	6"	99.00	115.00	62.00	70.00	93.00	108.00	115.00
ECDS-10DF	Square	10"	130.00	148.00	114.00	124.00	133.00	141.00	166.00

9.5" Patch Rail Split End Caps Only			Finish						
Part # (Add Finish)	Profile	Height	32D/630	32/629	28/628	314	314E/BSP/WSP	4E	OptiCoat™
ECDS-4AC-SP	Square	4"	161.00	181.00	137.00	151.00	189.00	209.00	237.00
ECDT-4AC-SP	Tapered	4"	161.00	181.00	137.00	151.00	189.00	209.00	237.00

Sidelite End Caps (Each)			Finish						
Part # (Add Finish)	Profile	Height	32D/630	32/629	28/628	314	314E/BSP/10BE	4E	OptiCoat™
ECSS-275AC	Square	2 3/4"	49.30	56.00	26.60	30.50	48.40	53.00	60.00
ECST-275AC	Tapered	2 3/4"	49.30	56.00	26.60	30.50	48.40	53.00	60.00
ECSS-4AC	Square	4"	40.90	46.90	19.00	22.80	39.60	43.60	49.60
ECST-4AC	Tapered	4"	40.90	46.90	19.00	22.80	39.60	43.60	49.60
ECSS-6AC	Square	6"	86.00	99.00	55.00	61.00	81.00	89.00	102.00
ECSS-10AC	Square	10"	113.00	130.00	100.00	108.00	116.00	128.00	146.00
ECSS-4DF	Square	4"	51.00	57.00	28.00	30.50	48.40	53.00	60.00
ECST-4DF	Tapered	4"	51.00	57.00	28.00	30.50	48.40	53.00	60.00

Deduct 1/4" from rail length for each end cap.

Vertical Stile End Caps		Finish							
Part # (Add Finish)	Description	32D/630	32/629	28/628	314	314E/BSP/WSP	4E	OptiCoat™	
ECDRVS-275	Vertical Stile End Cap for 2 3/4" Rail	85.00	99.00	73.00	88.00	88.00	93.00	110.00	
ECDRVS-4	Vertical Stile End Cap for 4" Rail	83.00	96.00	72.00	86.00	86.00	90.00	108.00	
ECDRVS-6	Vertical Stile End Cap for 6" Rail	83.00	96.00	72.00	86.00	86.00	90.00	108.00	
ECDRVS-10	Vertical Stile End Cap for 10" Rail	97.00	111.00	84.00	100.00	100.00	105.00	125.00	

Header End Caps		Finish							
Part # (Add Finish)	Description	32D/630	32/629	28/628	314	314E/BSP/WSP	4E	OptiCoat™	
ECH-1750x4000	1 3/4" x 4" End Cap	21.60	25.30	22.80	25.40	43.40	47.70	54.00	
ECH-1750x4500	1 3/4" x 4 1/2" End Cap	21.60	25.30	22.80	25.40	43.40	47.70	54.00	
ECH-1750x1750	1 3/4" x 1 3/4" Single End Cap for Floating Headers	14.40	15.70	14.00	15.20	33.50	36.80	41.90	
ECH-1750x2000	1 3/4" x 2" Single End Cap for Floating Headers	14.40	15.70	14.00	15.20	33.50	36.80	41.90	
ECH-2000x2750	2" x 2 3/4" Single End Cap for Floating Headers	14.40	15.70	14.00	15.20	33.50	36.80	41.90	
ECH-2000x2000	2" x 2" End Cap	14.40	15.70	14.00	15.20	33.50	36.80	41.90	
ECH-2000x6000	2" x 6" End Cap	24.10	27.60	25.40	26.60	44.50	49.00	56.00	

ASSA ABLOY

Experience a safer
and more open world

USA & Canada Prices Effective February 2, 2026 | Click Here for: [Canadian Tariffs](#)

The 2026 USA Price Book Tariff Adjustment will remain at 6.25% as previously communicated.

USA: 855 594 6989 • www.assaabloyglass.us | Canada: 800 461 3007 • www.assaabloydss.ca

Copyright © 2021-2026, ASSA ABLOY Accessories and Door Controls Group, Inc. All rights reserved. Reproduction in whole or in part without the express written permission of ASSA ABLOY Accessories and Door Controls Group, Inc. is prohibited.

The ASSA ABLOY Group is the global leader in access solutions.
Every day, we help billions of people experience a more open world.

ASSA ABLOY

ASSA ABLOY Opening Solutions leads the development within door openings and products for access solutions in homes, businesses and institutions. Our offering includes doors, frames, door and window hardware, mechanical and smart locks, access control and service.

ASSA ABLOY Opening Solutions
Glass Solutions
Somerset, PA
P: 855 594 6989 • F: 844 851 8665
www.assaabloyglass.us

Canada:
ASSA ABLOY Door Security Solutions
160 Four Valley Drive
Vaughan, ON L4K 4T9
P: 800 461 3007
www.assaabloydss.ca