

JAGUAR XJ



THE ART OF PERFORMANCE





BY APPOINTMENT TO
HM THE QUEEN
MANUFACTURERS OF
MOTOR VEHICLES
JAGUAR LAND ROVER LIMITED
COVENTRY



BY APPOINTMENT TO
HRH THE DUKE OF EDINBURGH
MANUFACTURERS OF
MOTOR VEHICLES
JAGUAR LAND ROVER LIMITED
COVENTRY



BY APPOINTMENT TO
HRH THE PRINCE OF WALES
MANUFACTURERS OF
MOTOR VEHICLES
JAGUAR LAND ROVER LIMITED
COVENTRY



THE ART OF PERFORMANCE

Every day we push performance to its limit. Our performance. Our cars' performance.
We innovate, we engineer, we design. We master rules and then break them.
Only to push further. Past the limits of convention. This is when performance becomes art.

Jaguar. The Art of Performance.



CONTENTS

INTRODUCTION

The Concept of XJ	06
XJ - The Facts	08

DESIGN

Exterior Principles	10
Exterior - A Powerful Look	13
Exterior View	15
Interior Technology	17
Interior Luxury	18
Interior Comfort	21
Interior Space	23

PERFORMANCE

Engines	24
All-Aluminium Body	26
Advanced Driving Dynamics	28
XJR575 - The Most Powerful and Agile XJ	33
XJR575 - Sporting Style	35

DRIVING TECHNOLOGY

Added Driver Confidence	36
Advanced Drivetrain Technology	38

TECHNOLOGY

Infotainment	41
Connectivity	42
Audio	46

SAFETY AND EFFICIENCY

Driver Assistance	48
Efficient Technologies	50

XJ50 SPECIAL EDITION

53

PERSONALISATION

XJ - Your Choice	56
Choose your Engine	58
Choose your Model	60
Choose your Colour	62
Choose your Wheels	64
Choose your Interior	66
Choose your Jaguar Gear - Accessories	84

TECHNICAL SPECIFICATIONS

86

SPECIAL VEHICLE OPERATIONS

90

THE WORLD OF JAGUAR

92

AT YOUR SERVICE

95

VEHICLE SHOWN: XJ R-SPORT STANDARD WHEELBASE IN SANTORINI BLACK WITH OPTIONAL FEATURES FITTED (MARKET DEPENDENT)
VEHICLES SHOWN ARE FROM THE JAGUAR GLOBAL RANGE. SPECIFICATIONS, OPTIONS AND AVAILABILITY MAY VARY BETWEEN MARKETS
AND SHOULD BE VERIFIED WITH YOUR LOCAL JAGUAR RETAILER. CO₂ AND FUEL ECONOMY FIGURES MAY VARY ACCORDING TO WHEEL
FITMENT AND OPTIONAL EXTRAS FITTED.

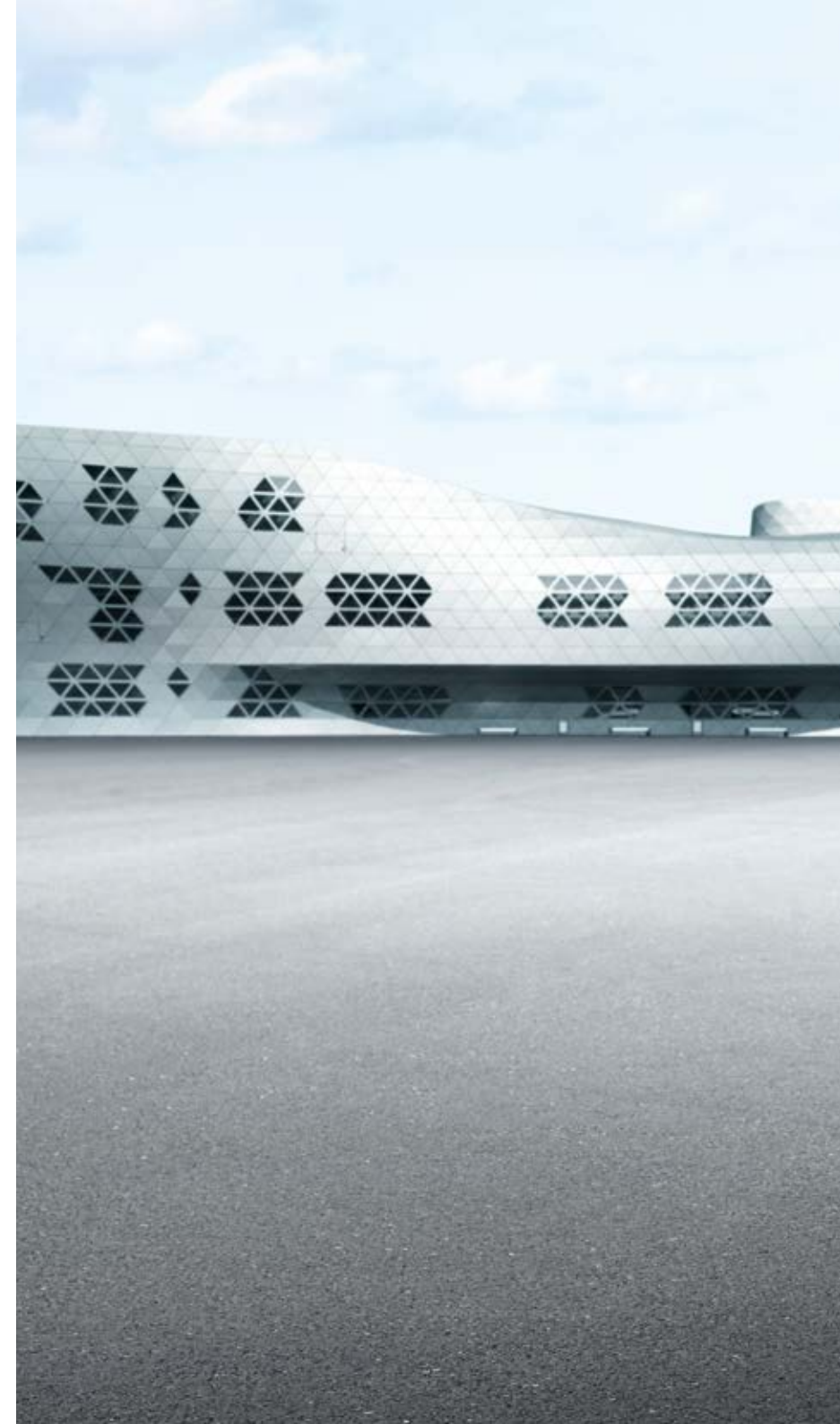

INTRODUCTION

THE CONCEPT OF XJ

XJ is Jaguar's pinnacle saloon car, the perfect combination of cutting-edge technology, sporting vehicle dynamics, and opulent luxury. In the cabin, there's space to stretch out, relax or work using our latest connected technology, Touch Pro. With Touch Pro's 10" Touchscreen and the availability of 4G Wi-Fi Internet, XJ has everything you need to make your journey more productive, entertaining and relaxed.

Always working with you to help keep all occupants safe, is an enhanced suite of Advanced Driver Assist Systems* including Autonomous Emergency Braking, Lane Keep Assist and Adaptive Cruise Control with Queue Assist. While energy-efficient full LED headlights, standard on every XJ, produce piercing beams of light with a quality close to daylight for safer driving.

For half a century, XJ has pushed the boundaries to deliver innovation and style. Today we mark this milestone with the special edition XJ50. With its advanced driving technologies and, of course, supreme comfort, the XJ50 truly is one of a kind.

*See page 48 for details.

In-car features should be used by drivers only when safe to do so. Drivers must retain full control of the vehicle at all times.

Standard and optional features may differ depending on market availability. Please consult your local Jaguar Retailer for details.

VEHICLE SHOWN: XJ AUTOBIOGRAPHY LONG WHEELBASE IN LOIRE BLUE WITH OPTIONAL FEATURES FITTED (MARKET DEPENDENT)



XJ - THE FACTS

Jaguar's technology is focused on enhancing the journey for you and your passengers. Dynamic systems assist performance, handling and comfort. XJ also features the latest connected technology and an array of luxury interior choices.

CONNECTED CAR

Connect Pro¹ is a package of applications and technologies that keeps XJ connected to the world. It runs a suite of useful smartphone apps from the 10" Touchscreen. Connect Pro's services, technologies and applications give you the very best in connectivity and convenience, all supported by a fast 4G Wi-Fi Internet connection through a powerful external antenna. With Remote Premium you can connect to, and monitor, your XJ from anywhere and even pre-heat or cool the cabin before entering.

PERFORMANCE AND EFFICIENCY

The XJ range offers a choice of performance engines, delivering everything from strong fuel economy to a top speed of 300km/h (186mph)². There is a powerful, refined 3.0 litre 300PS diesel engine offering fuel efficiency from 7.0 l/100km (up to 40.4mpg)³ and CO₂ emissions from just 184g/km³. It delivers 0-100km/h in 6.2 seconds (0-60mph in 5.9 seconds)³ thanks to a torque output of 700Nm. V6 and V8 petrol engines are also available to suit your driving needs. To smooth your progress, all models feature a sophisticated 8-speed Automatic Transmission.

ALL-ALUMINIUM CONSTRUCTION

XJ's all-aluminium body architecture is not only strong and rigid but also extremely light, making the car highly responsive and agile, as well as fuel efficient. Riveted, and without a single welded joint, the 100 percent aluminium monocoque body structure makes this one of the lightest cars in its class and, without any compromise to the integrity of its body, one of the safest.

¹Optional feature. ²Engine data has not been re-certified in 2019. Data shown conforms to the 2017 NEDC certification.

³The figures provided are as a result of official manufacturer's tests in accordance with EU legislation. For comparison purposes only. Real world figures may differ. CO₂ and fuel economy figures may vary according to wheel fitment and optional extras fitted. ⁴Standard on Portfolio, XJ50 and XJR575. Not available on other models.

Standard and optional features may differ depending on market availability. Please consult your local Jaguar Retailer for details.

Remote contains subscription services that can be extended after the initial term advised by your Jaguar Retailer. InControl features, options and their availability remain market dependent - check with your Jaguar Retailer for local market availability and full terms. Information and images displayed in relation to the InControl technology, including screens or sequences, are subject to software updates, version control and other system/visual changes depending on options selected. Mobile network connectivity cannot be guaranteed in all locations. InControl Apps and Remote App will need to be downloaded from the Apple/Play Store. All in-car features should be used by drivers only when safe for them to do so. Drivers must ensure they are in full control of the vehicle at all times.

VEHICLE SHOWN: XJ50 LONG WHEELBASE IN LOIRE BLUE WITH OPTIONAL FEATURES FITTED (MARKET DEPENDENT)

TOUCH PRO

Putting all the essential in-car controls and a world of entertainment at your fingertips is XJ's next-generation Touch Pro infotainment system. It features a larger 10" tablet-style Touchscreen with intuitive swipe and pinch-to-zoom navigation.

COLOURS AND MATERIALS

XJ provides true luxury choice throughout. A wealth of materials and finishes are at your disposal, including beautiful soft grain leather seats defined in a Diamond Quilted contrast stitched pattern⁴. Exclusive colour co-ordination continues throughout the cabin.



'DOUBLE J' HEADLIGHTS

Jaguar's unique 'Double J' Daytime Running Lights give XJ a distinctive appearance. The full LED headlights supply a 'whiter' light than conventional Xenon beams. Being closer to daylight, objects can be better recognised, helping increase comfort and safety during night driving.

WHEELS

XJ has an extensive selection of wheels and finishes including XJ50's exclusive 5 split-spoke 'Style 5045' alloy wheels with a Gloss Black and Diamond Turned finish.



DESIGN EXTERIOR PRINCIPLES



DESIGN PURITY

POWERFUL STANCE

XJ stands out: authoritative, elegant, and powerful. XJ's teardrop shape is formed for optimum aerodynamic efficiency, reducing air resistance and CO₂ emissions to a minimum, while improving acceleration and fuel efficiency. The shape is the result of exhaustive computational modelling where aesthetics and aerodynamics work together. The Chrome outlined side windows emphasise XJ's pure, elongated form. XJ's low, wide stance and long, taut waistline create a commanding presence, while inside, the cabin still feels airy and spacious thanks to its panoramic roof and smart design.

VEHICLE SHOWN: XJ AUTOBIOGRAPHY LONG WHEELBASE IN LOIRE BLUE WITH OPTIONAL FEATURES FITTED (MARKET DEPENDENT)







EXTERIOR - A POWERFUL LOOK

 **BOLD FRONT GRILLE** | **'DOUBLE J' HEADLIGHTS**

XJ's assertive front styling includes an upright front grille design with mesh detail. The grille is framed by energy efficient full LED headlights, sporting Jaguar's unique 'Double J' Daytime Running Light design. Producing a light with a colour temperature closer to natural daylight, objects can be better recognised, helping increase comfort and safety during night driving.

At the rear, finishing touches include elliptical tailpipes and LED tail lights incorporating a distinctive pinstripe graphic that provides a crisp and clear 'ribbon of light'. The LED tail lights are brighter, more efficient and illuminate faster than halogen bulbs, contributing to XJ's overall drive for greater efficiency.

VEHICLE SHOWN: XJ R-SPORT STANDARD WHEELBASE IN SANTORINI BLACK WITH OPTIONAL FEATURES FITTED (MARKET DEPENDENT)





EXTERIOR VIEW

FULL WIDTH PANORAMIC ROOF

The view from inside XJ is extensive: a panoramic, full width, heat-reflective glass roof sweeps back and over the rear seats. It filters UV rays and floods the interior with natural light making it feel airy, spacious and, thanks to effective tinting, very private. Power operated blinds allow you to completely block the light when required. Specially formulated toughened glass helps to keep the cabin cool.

VEHICLE SHOWN: XJ PORTFOLIO LONG WHEELBASE IN CARPATHIAN GREY WITH OPTIONAL FEATURES FITTED
(MARKET DEPENDENT)





INTERIOR TECHNOLOGY

CONNECTED INFOTAINMENT*

XJ's high-definition Interactive Driver Display puts everything you need to know about your driving right in front of you. The 12.3" screen displays the speed, fuel and temperature gauges and can be set to display the most relevant information, depending on the situation and set up. This multi-layered virtual display combines a user-friendly graphical interface with advanced functionality to make finding the right settings even easier.

The Interactive Driver Display is fully integrated with the 10" Touchscreen to put all information behind the wheel or on the centre console. For example, when working with Navigation Pro, the Interactive Driver Display can be reconfigured to show 3D mapping, making following your route even simpler.

*Optional feature.

Remote contains subscription services that can be extended after the initial term advised by your Jaguar Retailer. InControl features, options and their availability remain market dependent - check with your Jaguar Retailer for local market availability and full terms. Information and images displayed in relation to the InControl technology, including screens or sequences, are subject to software updates, version control and other system/visual changes depending on options selected. Mobile network connectivity cannot be guaranteed in all locations. InControl Apps and Remote App will need to be downloaded from the Apple/Play Store. All in-car features should be used by drivers only when safe for them to do so. Drivers must ensure they are in full control of the vehicle at all times.

INTERIOR SHOWN: XJ PORTFOLIO LONG WHEELBASE SHOWING IVORY SOFT GRAIN PERFORATED LEATHER SEATS WITH EBONY CONTRAST STITCH, EBONY UPPER FACIA, EBONY SUEDECLOTH HEADLINING AND GLOSS RICH OAK VENEER WITH OPTIONAL FEATURES FITTED (MARKET DEPENDENT)

INTERIOR LUXURY

 CRAFTSMANSHIP | EXTENSIVE CHOICE

The quality of craftsmanship throughout the XJ cabin sets it apart. With a wide choice of colours, materials and finishes, the interior reflects the clarity and purity of XJ's exterior. The hand-crafted veneer that runs right around the cabin accentuates the sense of space. Jaguar's sporting character is present in the controls and architecture surrounding the driver including the leather-wrapped, three-spoke steering wheel that offers key controls at your fingertips.

INTERIOR SHOWN: XJ PORTFOLIO LONG WHEELBASE WITH OPTIONAL PREMIUM REAR SEAT PACK SHOWING IVORY SOFT GRAIN PERFORATED LEATHER SEATS WITH EBONY CONTRAST STITCH, EBONY UPPER FACIA, EBONY SUEDECLOTH HEADLINING AND GLOSS RICH OAK VENEER WITH OPTIONAL FEATURES FITTED (MARKET DEPENDENT)







INTERIOR COMFORT



FRONT PASSENGER SEAT AWAY

HEATING AND COOLING FUNCTIONS

FIVE MASSAGE PROGRAMMES

XJ's multi-functional seating gives you complete control of your comfort. Both front seats feature fine-tuned electric adjustment and can be specified with five different massage programmes. Both front and rear seats are heated. All seats feature a cooling function as well (excluding XJ Luxury model). Some XJ models also offer three-position user memory on the driver and front passenger seats. Long Wheelbase models can be further enhanced with a choice of Rear Seat Option Packs, featuring two individual airline-style reclining seats complete with three massage programmes and memory. The reclining rear seats can be programmed to return to an upright position when the door is opened and a 'front passenger seat away' function allows rear occupants to move the empty front passenger seat forward to increase legroom and aid access.

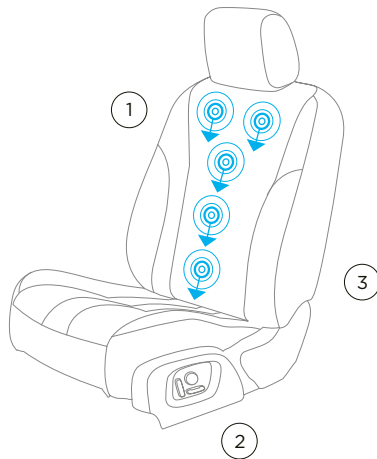

FRONT SEATS

Available with five different massage programmes, electric adjustment with three-position memory and heated/cooling function.

1. Five massage programmes
2. Three-position memory function
3. Cooling function

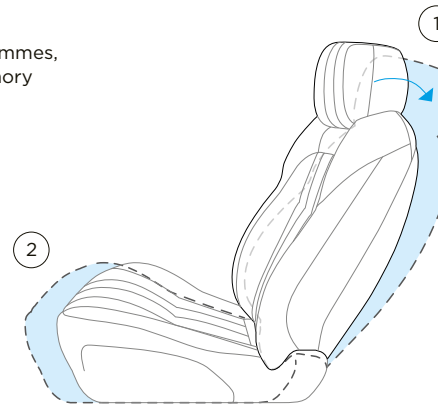

REAR SEATS

Available on Long Wheelbase models with airline-style recline, three different massage programmes, electric adjustment with two-position memory.

1. Total recline movement is 11 degrees
2. 103mm of longitudinal cushion movement and separate 14.5 degrees of upper articulation movement

Standard and optional features may differ depending on market availability. Please consult your local Jaguar Retailer for details.

INTERIOR SHOWN: XJ PORTFOLIO LONG WHEELBASE WITH OPTIONAL PREMIUM REAR SEAT PACK SHOWING IVORY SOFT GRAIN PERFORATED LEATHER SEATS WITH EBONY CONTRAST STITCH, EBONY UPPER FACIA, EBONY SUEDECLOTH HEADLINING AND GLOSS RICH OAK VENEER WITH OPTIONAL FEATURES FITTED (MARKET DEPENDENT)





1. LWB headroom 946mm 2. LWB kneeroom 189mm

INTERIOR SPACE



OVER A METRE OF LEGROOM

LIMOUSINE RIDE

Long Wheelbase (LWB) models feature over a metre of legroom for rear seat passengers providing the perfect environment to work, enjoy a host of entertainment options, or simply stretch out and relax. Long Wheelbase models also feature a unique 'limousine' ride with revised air suspension settings for even more refined comfort.

Depending on the model, or options chosen, the rear cabin can be further enhanced with individual 10" HD screens. The centre armrest houses the multimedia remote and front and rear seat controls, as well as providing useful storage. Folding business tables, LED reading lights, drop-in footrests and electric side rear window blinds are also available to add comfort, convenience and privacy.

Standard and optional features may differ depending on market availability. Please consult your local Jaguar Retailer for details.

INTERIOR SHOWN: XJ PORTFOLIO LONG WHEELBASE WITH OPTIONAL PREMIUM REAR SEAT PACK SHOWING IVORY SOFT GRAIN PERFORATED LEATHER SEATS WITH EBONY CONTRAST STITCH, EBONY UPPER FACIA, EBONY SUEDECLOTH HEADLINING AND GLOSS RICH OAK VENEER WITH OPTIONAL FEATURES FITTED (MARKET DEPENDENT)

PERFORMANCE ENGINES



STOP/START* TECHNOLOGY

EFFICIENT DIESEL ENGINE

XJ offers a choice of a V6 Turbocharged Diesel engine or three petrol engines. All petrol engines are supercharged and range from the 3.0 litre V6 340PS Supercharged to the 5.0 litre V8 510PS Supercharged and the powerful 5.0 litre V8 575PS Supercharged. All engines feature Intelligent Stop/Start* to further improve XJ's fuel efficiency and reduce CO₂ emissions. For information on fuel consumption, CO₂ emissions and performance figures for XJ engines, please refer to pages 86 to 87.



DIESEL ENGINE FROM
184g/km CO₂**

The 3.0 litre V6 300PS Turbocharged Diesel engine offers exceptional refinement and efficiency, including an impressive torque figure of up to 700Nm for improved performance and excellent drivability. Its high pressure common rail fuel system delivers efficient combustion and fewer emissions. The engine uses innovative twin parallel sequential turbocharging – a concept pioneered by Jaguar Land Rover – for smooth, more immediate delivery of power at all engine speeds. It is capable of 0-100km/h in 6.2** seconds (0-60mph in 5.9 seconds) with CO₂ emissions of just 184g/km** CO₂ and fuel economy from 7.0 l/100km (up to 40.4 mpg)**, on the European Combined Cycle.

The engine uses an 8-speed Automatic Transmission and also includes Stop/Start* technology.

*Market dependent.

**The figures provided are as a result of official manufacturer's tests in accordance with EU legislation. For comparison purposes only. Real world figures may differ. CO₂ and fuel economy figures may vary according to wheel fitment and optional extras fitted.

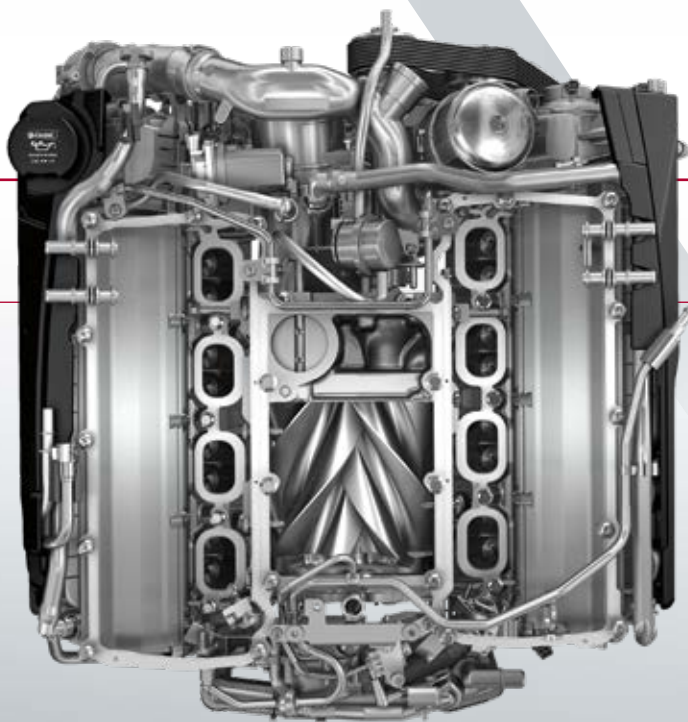

PETROL ENGINES FROM

0-100km/h in 4.4 sec [0-60mph in 4.2 sec]

A choice of three petrol engines means that you can select the ideal engine to suit your driving style. The 340PS 3.0 litre V6 Supercharged Petrol engine includes a Roots-type supercharger, which is mounted in the 'V' between the two rows of cylinders for compact dimensions. Supercharging provides linear delivery of power and maximises responsiveness. This results in performance matching much larger engines, while optimising economy and reducing emissions. The 510PS and 575PS 5.0 litre V8 Supercharged engines are both engineered for smoothness, power and incredible performance.

ALL-ALUMINIUM BODY



AGILITY ENHANCED

ECONOMY IMPROVED

100% ALUMINIUM

XJ's all-aluminium body, the core of its dynamic performance, creates a stiffer, stronger and, most importantly, lighter architecture. Developed using aerospace bonding and riveting techniques, XJ's 100 percent aluminium monocoque body structure does not have a single welded joint. With up to 50 percent of XJ's aluminium coming from recycled sources, XJ leads the way in sustainability.

One of the lightest cars in its class, XJ's excellent power-to-weight ratio improves all aspects of performance with no compromise to its strength. Acceleration is improved, and because the engine has to work less, it lowers fuel consumption and emissions. Its aluminium construction also enhances ride comfort, handling, agility and feel, connecting the driver seamlessly to the car and the road.

The inherent strength of aluminium and the monocoque construction offer safety benefits too. The lower weight improves braking performance and reduces the kinetic energy involved in any impact. Aluminium absorbs significantly more energy than steel when it is deformed and, because there are fewer joints, XJ's strength is increased further still.

VEHICLE SHOWN: XJ AUTOBIOGRAPHY LONG WHEELBASE IN LOIRE BLUE WITH OPTIONAL FEATURES FITTED (MARKET DEPENDENT)

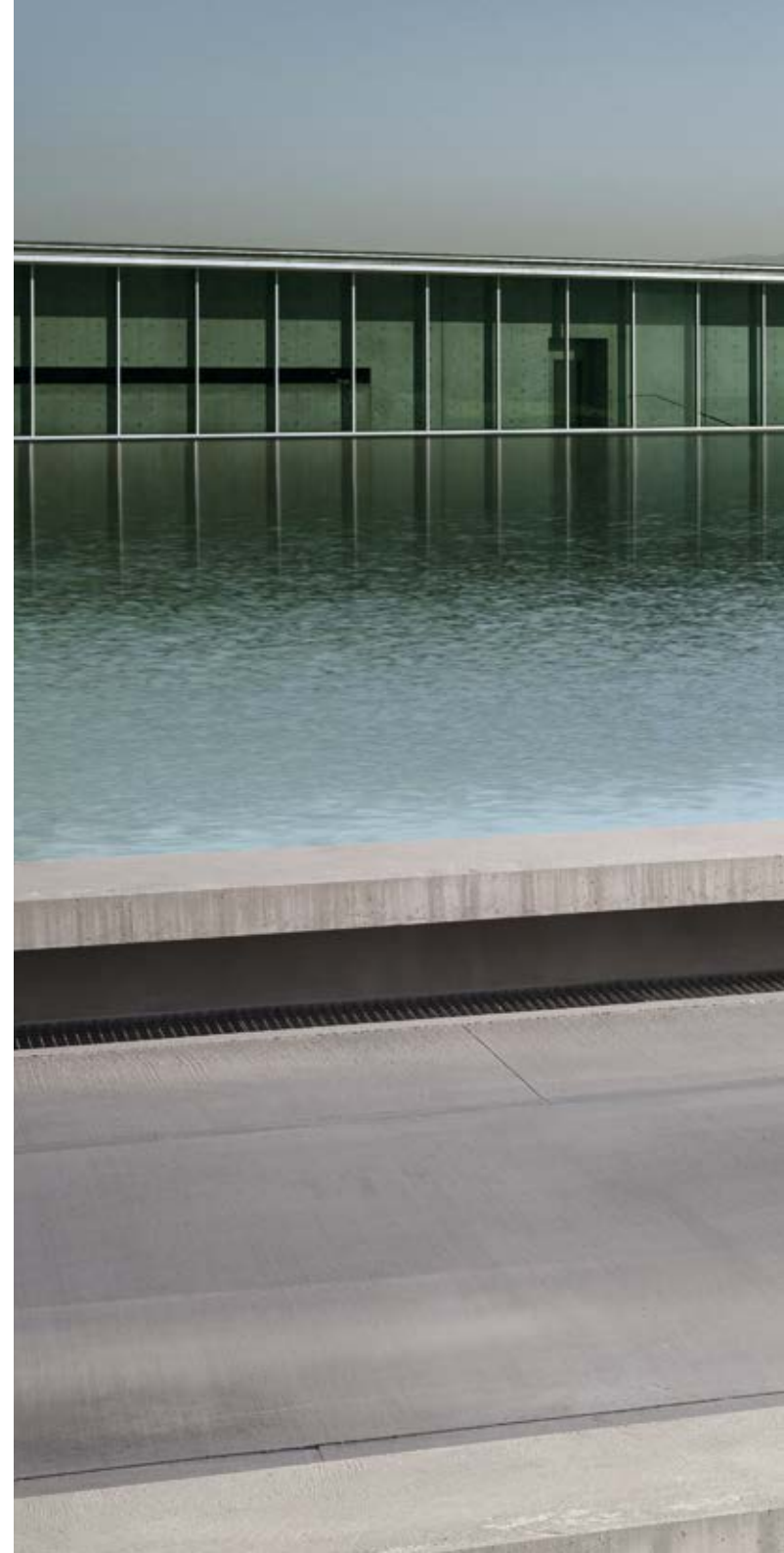



ADVANCED DRIVING DYNAMICS



AIR SUSPENSION SYSTEM

ADAPTIVE DYNAMICS

XJ delivers the comfort and refinement of a luxury car with the responsiveness and driver involvement of a sports car. Whether you're cornering, navigating uneven surfaces or accelerating, XJ's Adaptive Dynamics system continually monitors the car up to 500 times a second. Working in conjunction with the air suspension it constantly varies the damping to suit the conditions. These intelligent adjustments keep XJ flat and stable, improving control without loss of ride comfort. In unexpected road and weather conditions, Dynamic Stability Control (DSC) reacts as soon as the system detects the wheels slipping. Trac DSC provides a sportier drive and assists when using snow chains by allowing some slippage or overspin before the system engages. XJ also features selectable driving modes for specific performance requirements. In addition to 'Drive' and 'Sport', Dynamic Mode gives more responsive acceleration, while Winter Mode delivers more progressive control in slippery conditions.

VEHICLE SHOWN: XJ PORTFOLIO LONG WHEELBASE IN CARPATHIAN GREY WITH OPTIONAL FEATURES FITTED (MARKET DEPENDENT)













XJR575 - THE MOST POWERFUL AND AGILE XJ

 **5.0 LITRE SUPERCHARGED V8** | **ELECTRONIC ACTIVE DIFFERENTIAL**

XJR575's breathtaking power and razor-sharp responsiveness help deliver new levels of dynamic ability in a luxury saloon car. It is the epitome of technology, performance and seductive design – everything Jaguar stands for in the 21st century. This flagship Jaguar matches supercar performance with a stealthy, purposeful appearance. The 5.0 litre Supercharged V8 engine at its heart generates a formidable 575PS and 700Nm torque, powering XJR575 to a top speed of 300km/h (186 mph).

Capable of accelerating from 0-100km/h in just 4.4 seconds (0-60 mph in 4.2 seconds), XJR575's driving dynamics are assisted by an innovative Electronic Active Differential. This technology enables fine control of power delivery, maximising traction and limiting the occurrence of wheelspin. Working in conjunction with the Dynamic Stability Control and ABS systems, the Electronic Active Differential uses an electric motor, acting on a multi-plate clutch to manage the delivery of torque to the rear wheels. Full electronic control of the rear differential lock enables the system to apply full locking torque almost instantaneously, allowing the driver to exploit the thrilling performance potential of XJR575.

Subtle exterior design cues optimise the flow of air over and around the car, and signify the sporting intent of this most focused, agile and responsive member of the XJ family. The XJR575 is given even more visual muscularity by a revised rear spoiler, side sills, front bumper, splitter and lower air intakes featuring Gloss Black surrounds.

Unique exterior styling includes XJR575 badging and twin bonnet louvres, as well as Red painted brake calipers and 20" 5 split-spoke 'Style 5044' forged alloy wheels finished in Gloss Black. Also available as a visual enhancement are Satin Corris Grey and Velocity Blue high quality Special Vehicle Operations Premium Palette paint finishes.

Engine availability is market dependent. Please consult your local Jaguar Retailer for details.

VEHICLE SHOWN LEFT AND PREVIOUS PAGE: XJR575 STANDARD WHEELBASE IN SATIN CORRIS GREY WITH OPTIONAL FEATURES FITTED (MARKET DEPENDENT)





XJR575 - SPORTING STYLE

SOFT GRAIN LEATHER SPORT SEATS

XJR575 offers an unrivalled combination of sporting style, contemporary luxury and breathtaking performance. Its sport seats feature adjustable bolsters that provide the driver and passenger with lateral support during hard cornering. They are upholstered in soft grain leather offered in two bold colourways, either Ebony with Pimento stitch or Ivory with Ebony stitch. This is complemented with a Carbon Fibre veneer or optional Piano Black veneer. The XJR575 logo appears on the treadplates, dashboard intaglio and is embroidered on the front and rear seats.

INTERIOR SHOWN: XJR575 STANDARD WHEELBASE WITH EBONY SOFT GRAIN LEATHER SPORT SEATS WITH PIMENTO CONTRAST STITCH, EBONY UPPER FACIA, EBONY SUEDECLOTH HEADLINING, CARBON FIBRE VENEER AND EBONY PREMIUM CARPET MATS WITH PIMENTO CONTRAST BINDING WITH OPTIONAL FEATURES FITTED (MARKET DEPENDENT)

DRIVING TECHNOLOGY

ADDED DRIVER CONFIDENCE

ALL SURFACE PROGRESS CONTROL

Standard on every XJ, Jaguar's All Surface Progress Control (ASPC) technology is a low speed cruise control that helps the car to cope with low traction situations. ASPC allows the driver to concentrate on steering the vehicle. Once activated, you use the cruise control buttons to set a 'target' speed of between 3.6km/h and 30km/h (2mph and 19mph).

The system then works to achieve and maintain that speed while exerting optimum traction control. ASPC gives XJ drivers added confidence over slippery, loose or icy surfaces, undulating terrain and even while descending a difficult incline. It helps make XJ easy to drive in challenging conditions.

With any given set of tyres, ASPC can accomplish comparable levels of traction to that achievable by an expert driver. Fitting all-season or winter tyres to XJ can improve capability on slippery surfaces.



GRAVEL



WET GRASS



SNOW/ICE



WET ROAD

ADVANCED DRIVETRAIN TECHNOLOGY



ALL WHEEL DRIVE

OVER 90% TORQUE SPLIT

INTELLIGENT AND ADAPTIVE

The optional Jaguar All Wheel Drive (AWD) system is continuously variable and intelligent. The rear wheel bias ensures a consistently true Jaguar driving experience. In normal conditions an XJ with the AWD system behaves like a Rear Wheel Drive vehicle but reacts intelligently to road conditions to deliver traction on demand. The AWD system reacts in the blink of an eye, so should the rear wheels start to slip, it instantly redistributes torque to compensate. Over 90 percent of engine torque can be distributed from the rear wheels to the front wheels to provide optimum traction. As well as offering a smoother, safer drive with the familiar Jaguar agility and handling, it also consumes less fuel and has lower emissions than a permanent AWD system.

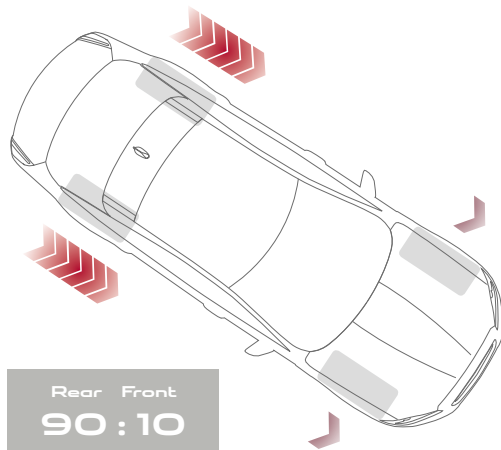

DRY ROAD CONDITIONS

In normal driving conditions, virtually all torque is distributed to the rear wheels, providing signature Jaguar Rear Wheel Drive performance.

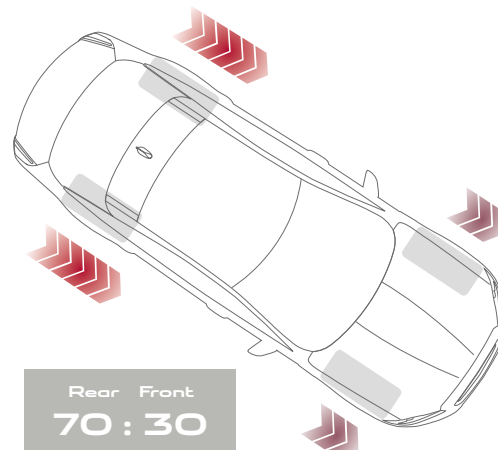

AWD WINTER MODE

At the touch of a button, AWD Winter Mode can be selected to distribute 30 percent of the torque to the front wheels and 70 percent of the torque to the rear wheels, maximising control in difficult conditions.

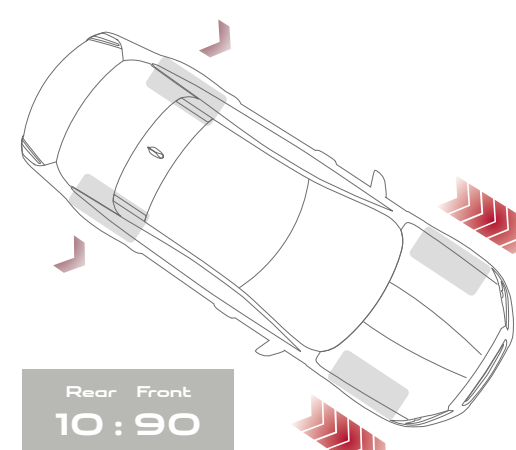

VARIABLE ROAD CONDITIONS

Where road conditions are changeable, over 90 percent of torque can be distributed to the front wheels as required, to ensure optimum traction.

Standard and optional features may differ depending on market availability. Please consult your local Jaguar Retailer for details.

VEHICLE SHOWN: XJ AUTOBIOGRAPHY LONG WHEELBASE IN LOIRE BLUE WITH OPTIONAL FEATURES FITTED (MARKET DEPENDENT)





Carrer d'Aragó

50

Carrer de Numància

Auto: 5.0km

5341 km

START/STOP

ALBUMS

17.06

FA 4G

Young before your time

Corvidae

Electric Storm



28°C

28°

16°

★ Barcelona

AUTO

A/C

AUTO

TECHNOLOGY INFOTAINMENT

Delivering a wealth of information and entertainment, every XJ is equipped with our InControl infotainment system, Touch Pro. It features intuitive and advanced integrated technologies to ensure everyone can make the most of their journey.

10" TOUCH PRO

The standard 10" Touchscreen at the heart of the centre console supports swipe and pinch-to-zoom gestures and delivers our richest ever audio-visual entertainment. To enhance the in-car experience, Touch Pro offers customisable homescreens and fast response times as well as voice control. Multi-tasking is also made easy thanks to the Interactive Side Panel.

INTERIOR SHOWN: XJ PORTFOLIO LONG WHEELBASE SHOWING EBONY SOFT GRAIN PERFORATED LEATHER SEATS WITH OPTIONAL FEATURES FITTED (MARKET DEPENDENT)

CONNECTIVITY

InControl is Jaguar's suite of standard and optional features that connects you to your vehicle and links you seamlessly, and securely, with the outside world. There are a range of packs and options available to choose from. With a selection of apps, even when you're away from your car, some of the InControl features stay with you, making sure the Jaguar experience is more enjoyable than ever.

STANDARD FEATURES

NAVIGATION PRO

Standard on all models, Navigation Pro allows you to save your favourite places, use pinch-to-zoom gestures for simple map exploration and display a choice of either 2D or 3D crystal clear map graphics.

CONNECT PRO PACK

Connect Pro consists of InControl Apps, Remote and Pro Services. It's designed to enhance your in-car and out-of-car experience, ensuring you and your passengers enjoy the journey whilst remaining connected to the world.

INCONTROL APPS

Features a range of Jaguar approved apps that can be connected to XJ from your smartphone. It ensures safe and convenient use of apps optimised to enhance aspects of your in-car experience. You can also download third-party apps offering a vast range of services. Applications include:

- Tile¹ - Helps you find lost or misplaced items in seconds. Attach a tiny Bluetooth tracker Tile to your keys, wallet or bag. The easy-to-use Tile app can then help you find these items should they be misplaced. The app is accessible any time through your vehicle's Touchscreen, allowing you to make sure you have everything you need with you, before you set off on your journey.

¹Bluetooth tracker tiles must be purchased separately. 2016 Tile Inc. and the Tile design are trademarks of Tile, Inc.

²When power fold mirrors are specified.



REMOTE PREMIUM

Remote Premium provides information on your vehicle and enables you to interact with it remotely. Compatible with most smartphones, Android Wear™ or the Apple Watch®, this service includes:

- Remote Lock/Unlock – Lock or unlock your doors remotely with the click of a button. Simply press the 'lock' button on the Vehicle Security screen of the Remote smartphone app to single lock the doors, arm the alarm, fold in the wing mirrors² and close the windows. Press the 'unlock' button to unfold the wing mirrors, turn on the dipped headlights and cause the hazard lights to flash twice.
- Remote Climate – Prepare your XJ in advance by pre-heating or pre-cooling the cabin, so that you and your passengers are comfortable from the moment you step inside.
- Beep/Flash – This feature turns on your Jaguar's hazard lights, dipped headlights and sounds an audible alert to help you locate your vehicle in a crowded car park.

- Journey Tracking – This opt-in feature can automatically record your journey history including your route and mileage statistics. This information can be exported by email to use for expense reporting and can be imported to a spreadsheet.
- Vehicle Status Check – Check current fuel level and range, and status of door and window position and locks. See the last parked location of the vehicle and find your way back to it with on-foot directions.

Jaguar Optimised Assistance – You can make a direct call to the Jaguar Assistance team by pressing the button on the overhead console or from the Assistance screen within the InControl Remote smartphone app.

SOS Emergency Call – In a more serious incident, SOS Emergency Call will automatically connect you to the emergency response team who will notify the emergency services to your location. For peace of mind, this service is provided for the first ten years from date of registration.

Remote contains subscription services that can be extended after the initial term advised by your Jaguar Retailer. InControl features, options and their availability remain market dependent – check with your Jaguar Retailer for local market availability and full terms. Information and images displayed in relation to the InControl technology, including screens or sequences, are subject to software updates, version control and other system/visual changes depending on options selected. Mobile network connectivity cannot be guaranteed in all locations. InControl Apps and Remote App will need to be downloaded from the Apple/Play Store. All in-car features should be used by drivers only when safe for them to do so. Drivers must ensure they are in full control of the vehicle at all times.

STANDARD FEATURES

PRO SERVICES¹

- **Real Time Traffic Information** – Uses live traffic data feeds to give you the most accurate picture of what the traffic is like on the way to your destination.
- **Online Search** – Wherever you are, you can search the surrounding area for places of interest. The system can access expert destination information, travel tips and inspiration as well as online travel reviews of the local area.
- **Planning Routes and Door-to-Door Routing** – Before setting off, use the Route Planner app or go online to search, save locations or set your destination. The app uses the Cloud to send your destination automatically to your vehicle's navigation screen. Once you've parked, the Route Planner app will guide you to your destination – a true door-to-door experience which includes public transport options.
- **Share ETA** – You can share your estimated time of arrival so your selected contact(s) will know exactly when you will arrive, as calculated by the navigation guidance system. If you're running late, Share ETA can then send automatic updates via text messages or email, without any further action from you.
- **Satellite View** – When you want to get the context of your surroundings from overhead, simply switch to satellite view.
- **Commute Mode** – Allows the system to learn your commutes and automatically advises you of the expected journey time based on live and historical traffic movements without you having to input a destination. The system learns the routes you take for a given destination and then advises which of those is the quickest. The feature can be turned on and off dependent on driver preference.

- **Parking Service** – As you approach your destination, you can see where parking is available. Simply tap on your preferred car park and the navigation system updates to direct you to it.
- **Online Routing** – While you're on your way to a destination the system monitors live traffic conditions and takes into account typical traffic patterns for that time of day, keeping you on the optimum route.
- **Safety Cameras** – Alerts you to the location of accident black spots monitored by safety cameras.
- **Fuel Prices** – When you're going to fill up, the Fuel Price service not only finds filling stations along your route, it also enables you to compare fuel prices so you can keep your costs down.

WI-FI HOTSPOT

Wi-Fi Hotspot gives you the option to create a strong 4G hotspot using the car's antenna when you fit a SIM card. Connect up to eight devices to read emails, browse the web and download content.

OPTIONAL FEATURE

SECURE TRACKER²

Uses tracking technology to alert you to an attempted theft, and signals your vehicle's location to the relevant authorities, for a timely recovery.

¹Features within Pro Services may vary between markets.

²Secure Tracker will require further subscription after the initial term as advised by your Jaguar Retailer.

iPhone® is a registered trademark of Apple Inc., registered in the US and other countries.

Please ensure iPhone compatibility is reviewed with your local Jaguar Retailer.

Remote contains subscription services that can be extended after the initial term advised by your Jaguar Retailer. InControl features, options and their availability remain market dependent – check with your Jaguar Retailer for local market availability and full terms. Information and images displayed in relation to the InControl technology, including screens or sequences, are subject to software updates, version control and other system/visual changes depending on options selected. Mobile network connectivity cannot be guaranteed in all locations. InControl Apps and Remote App will need to be downloaded from the Apple/Play Store. All in-car features should be used by drivers only when safe for them to do so. Drivers must ensure they are in full control of the vehicle at all times.

ALBUMS

14:56

Young before your time
Corvidae

4G

Electric Storm



28°C 28°
16°

< ★ New York >



AUDIO

A vehicle's cabin is the ideal place within which to experience your personal choice of music and Jaguar XJ has the option of four different audio systems to bring your music to life:



ENHANCED SOUND SYSTEM

Excellent acoustic range through 12 speakers.

MERIDIAN™ SOUND SYSTEM

Great definition, crystal clear highs and full, deep bass – delivered through the careful arrangement of 12 speakers plus two subwoofers.

DIGITAL AUDIO BROADCAST (DAB) RADIO

The option of DAB radio technology offers improved sound quality, a wide choice of stations and live text information about the station, show and song you are listening to.

MERIDIAN SURROUND SOUND SYSTEM

All the fullness and clarity of a live performance delivered through an arrangement of 18 front, side and rear speakers plus two subwoofers – seamlessly brought together using Trifield™ technology. Exclusive to Meridian, Trifield perfectly blends the centre and surround channels with left and right channels ensuring an optimum, consistent sound experience for each passenger.













MERIDIAN REFERENCE SOUND SYSTEM

The ultra-premium Meridian Reference 1300W Sound System uses 24 speakers and 2 subwoofers. Employing psychoacoustics, it produces sounds that are so true to life they are perceived by the brain as the real thing.

Standard and optional features may differ depending on derivative and market availability. Please consult your local Jaguar Retailer for details.

MERIDIAN™

Formed in 1977 in Cambridgeshire, England, Jaguar's audio partner Meridian has pioneered many firsts including active speakers and the world's first digital surround sound processor. Meridian's audio technology input has helped ensure that Jaguar XJ is the most superb space within which to experience sound. Meridian Cabin Correction technology was utilised to analyse cabin shape, acoustics and resonance characteristics in order to help remove unwanted sounds. The advanced algorithm ensures that the rhythm, punch and timing of any piece of music are heard precisely how the artist intended, providing a consistently exceptional quality audio experience for all passengers in the vehicle.

	UNIQUE MERIDIAN TECHNOLOGY	SPEAKERS AND SUBWOOFERS	WATTS
ENHANCED SOUND	N/A	12	250
MERIDIAN™ SOUND	  	12+2	380
MERIDIAN™ SURROUND SOUND	   	18+2	825
MERIDIAN™ REFERENCE SOUND	    	24+2	1300



DIGITAL SIGNAL PROCESSING

Brings all elements of the audio system together as one, for performance that would otherwise require significantly larger speakers.



MERIDIAN CABIN CORRECTION

The advanced algorithm of Meridian's Cabin Correction tailors the sound experience to the precise acoustics of XJ's interior.



MERIDIAN DIGITAL DITHER SHAPING

To maintain the quality of musical recordings, they are converted into a common digital format. Meridian Digital Dither Shaping ensures that digital signal conversions are made smoothly and seamlessly, preserving the finest details of the audio performance. The result is authentic musical conversion, evoking the emotions of the original recording.



TRIFIELD

Exclusive to Meridian, Trifield blends the centre and surround channels seamlessly with left and right channels, delivering a consistent, concert-like experience for all occupants.



CONVERSATION ASSIST

Conversation Assist, included as standard with the Meridian Reference 1300W Sound System, allows the driver or front seat passenger to talk with ease to passengers in the rear of the car, and vice versa. Microphones above each seat reinforce the occupants' voices via the audio system's speakers, making it much easier for everyone to be heard.

SAFETY AND EFFICIENCY DRIVER ASSISTANCE

XJ is equipped with an array of standard and optional Driver Assist Systems dependent on the chosen model. All are designed to make driving easier and safer.

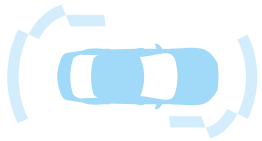

360° PARKING AID

360° Parking Aid uses ultrasonic sensors to the front, rear and sides of the vehicle to alert you to the proximity of objects when parking or exiting from a bay.



ADAPTIVE FRONT LIGHTING

Adaptive Front Lighting adapts to steering inputs to cast a deeper beam into corners, while its Intelligent Auto High Beam Assist senses oncoming vehicles and automatically selects high or dipped beam as appropriate.



AUTONOMOUS EMERGENCY BRAKING¹

Should a potential collision with another vehicle be detected, XJ gives an audible forward collision warning. Visual warnings follow. If the driver takes no action, the system applies the brakes to help reduce the severity of the possible impact.



TRAFFIC SIGN RECOGNITION AND ADAPTIVE SPEED LIMITER

Traffic Sign Recognition technology can detect current speed limit signs to display them on the Interactive Driver Display. This smart system is also aware of local and conditional speed limits. When activated, our Adaptive Speed Limiter uses Traffic Sign Recognition information to adjust your car's speed accordingly.

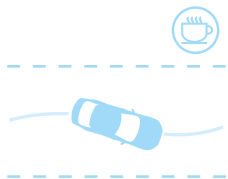

DRIVER CONDITION MONITOR¹

Driver Condition Monitor detects if you're starting to feel drowsy or fatigued - giving you an early warning when you need to take a break.



PARK ASSIST¹

Park Assist makes life in the city easier. The system works for both parallel and perpendicular parking and automatically steers XJ into and out of a space while the driver operates the pedals.

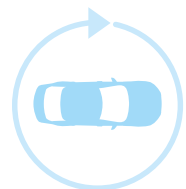

360° SURROUND CAMERA

Provides a 360° exterior view via the Touchscreen, helping with various manoeuvres from parking by a kerb, to getting in and out of tight spaces and junctions.



ADAPTIVE CRUISE CONTROL WITH QUEUE ASSIST

Adaptive Cruise Control with Queue Assist will keep your vehicle a set distance from the one in front should it slow or stop when you're cruising on the motorway or travelling in slow-moving traffic. Should the vehicle in front stop completely, your vehicle will come to a smooth halt. Once the traffic moves, simply touch the accelerator and Adaptive Cruise Control will resume following the car in front. The system can be activated from 16km/h (10mph) up to motorway speeds.

¹Available on Rear Wheel Drive (RWD) models only. ²Available on All Wheel Drive (AWD) models only.

Standard and optional features may differ depending on derivative and market availability. Please consult your local Jaguar Retailer for details.

All in-car features should be used by drivers only when safe for them to do so. Drivers must ensure they are in full control of the vehicle at all times.

For more details on feature availability configure your vehicle at jaguar.com

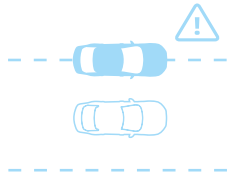

LANE DEPARTURE WARNING¹

Lane Departure Warning can help make long journeys much safer. It senses when your car is unintentionally drifting out of your lane, and notifies you with a visual alert and a gentle vibration of the steering wheel.

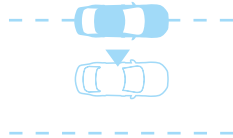

LANE KEEP ASSIST¹

Working in conjunction with Lane Departure Warning, Lane Keep Assist senses when your car is unintentionally drifting out of your lane, and gently steers you back.



PEDESTRIAN CONTACT SENSING

Help protect the people outside your car as well as those inside. If the car makes contact with a pedestrian, our Pedestrian Contact Sensing system is designed to automatically raise the bonnet to help cushion a potential impact.



BLIND SPOT MONITOR²

Blind Spot Monitor alerts you to vehicles in, or quickly approaching your blind spot. When a vehicle is detected, a small warning light will illuminate in the corresponding wing mirror. If you indicate in the direction of the obstacle, the warning light will flash to highlight potential danger.



BLIND SPOT ASSIST¹

Blind Spot Assist can help you prevent collisions. If your vehicle detects another car in your blind spot when you begin to change lanes, a small warning light illuminates in the corresponding wing mirror and a steering torque encourages you to guide your vehicle away from the approaching vehicle.



REVERSE TRAFFIC DETECTION

Reverse Traffic Detection is particularly useful when reversing out of a parking bay. The system warns you of vehicles, pedestrians or other hazards, approaching from either side of your vehicle. It will alert you with both audio and visual warnings so you know what's behind you even when the view is obstructed.

EFFICIENT TECHNOLOGIES

 **STOP/START* TECHNOLOGY** | **CLEAN TECHNOLOGIES**

We are determined to do more with less. That is why XJ uses a range of technologies to reduce fuel consumption and CO₂ emissions, all while staying true to Jaguar's dynamic nature.



STOP/START* TECHNOLOGY

All XJ engines utilise Stop/Start* technology. It shuts down the engine when you come to a complete halt and restarts the engine immediately when required, helping to save fuel, especially during urban driving.

*Market dependent.

Standard and optional features may differ depending on derivative and market availability. Please consult your local Jaguar Retailer for details.



ELECTRIC POWER ASSISTED STEERING (EPAS)

XJ's next generation Electric Power Assisted Steering (EPAS) offers outstanding feedback, control and immediate power assistance. Electrically driven, it's only active on demand which saves fuel. Only available on Rear Wheel Drive vehicles.



AERODYNAMICS

XJ's highly efficient shape is the result of hundreds of thousands of hours of Computational Fluid Dynamics testing. Jaguar created one of the world's most advanced automotive virtual testing labs, honing XJ's shape through virtual wind tunnels to slice through wind resistance.

AdBlue®

ADBLUE*

XJ's diesel engine is fitted with AdBlue to help clean exhaust gases. AdBlue is a non-toxic, non-flammable, biodegradable additive that processes the gases in the car's exhaust system to remove harmful nitrogen oxide emissions.



ALUMINIUM ARCHITECTURE

XJ's All-Aluminium architecture makes it one of the lightest vehicles in its class, meaning less fuel is needed to move it and consequently creating lower emissions. With up to 50 percent of the aluminium used coming from recycled sources, XJ's green credentials are assured.





XJ50 - CELEBRATING THE PAST, LOOKING TO THE FUTURE

For 50 years, XJ has been synonymous with innovation, style and attention to detail. The special edition XJ50 celebrates this triumph of British design and craftsmanship. With a refined engine, a lightning fast transmission and a range of advanced driving technologies, XJ50 delivers the refinement of a luxury car with the responsiveness and driver involvement of a sports car. Subtle Chrome XJ50 badging on the side vents and boot lid distinguish this flagship Jaguar from its counterparts.

VEHICLE SHOWN: XJ50 LONG WHEELBASE IN LOIRE BLUE WITH OPTIONAL FEATURES FITTED (MARKET DEPENDENT)



FLAWLESS CRAFTSMANSHIP SINCE 1968

XJ50 is available in four specially selected exterior colours – Fuji White, Santorini Black, Rosello Red and Loire Blue. Complementing the elegant and sporty exterior are the new and exclusive to XJ50 5 split-spoke 'Style 5045' alloy wheels with a Gloss Black and Diamond Turned finish. On the inside, unique design features and meticulous attention to detail set XJ50 apart. Illuminated XJ50 branded treadplates draw you into a cabin that honours style and elegance. The dashboard intaglio and front armrest also feature the XJ50 logo. Delightful to touch, soft grain leather with Diamond sew pattern and twin-needle contrast stitching covers the seats, instrument panel and doors. Headrests embossed with the Jaguar leaper and a hand-crafted Gloss Shadow Walnut veneer add to the luxurious ambience.

Standard and optional features may differ depending on derivative and market availability. Please consult your local Jaguar Retailer for details.

VEHICLE SHOWN: XJ50 LONG WHEELBASE IN LOIRE BLUE WITH OPTIONAL FEATURES FITTED (MARKET DEPENDENT)



PERSONALISATION XJ - YOUR CHOICE

 Configure your vehicle at jaguar.com



1 CHOOSE YOUR ENGINE

Page 58

Select one of XJ's powerful, efficient petrol or diesel engines to suit your driving style.

2 CHOOSE YOUR MODEL

Page 60

Compare the wealth of features on XJ models.

3 CHOOSE YOUR COLOUR

Page 62

Express your individuality with one of XJ's stunning exterior colours.



CHOOSE YOUR
WHEELS

Page 64

Add the personal finishing touch to your new XJ, and complement its stunning style, with a set of beautifully designed alloy wheels.



CHOOSE YOUR
INTERIOR

Page 66

There's a wide selection of premium materials, leathers, veneers and finishes for every personal taste.



CHOOSE YOUR
JAGUAR GEAR

Page 84

Really make it yours by adding style, practicality and versatility with official XJ Gear Accessories from your local Jaguar Retailer.

1 CHOOSE YOUR ENGINE

 Configure your vehicle at jaguar.com

> PETROL ENGINES

3.0 LITRE V6¹

SUPERCHARGED PETROL RWD

MAXIMUM POWER 340PS

MAXIMUM TORQUE 450Nm

ACCELERATION 0-100km/h 5.9 seconds,
0-60mph 5.7 seconds

TOP SPEED 250km/h/155mph limited

COMBINED: From 9.1 l/100km (Up to 31.0 mpg)

CO₂ EMISSIONS: From 211g/km

LUXURY, PREMIUM LUXURY, PORTFOLIO,
AUTOBIOGRAPHY, XJ50, R-SPORT



0-100 KM/H



TOP SPEED KM/H

3.0 LITRE V6¹

SUPERCHARGED PETROL AWD

MAXIMUM POWER 340PS

MAXIMUM TORQUE 450Nm

ACCELERATION 0-100km/h 6.4 seconds,
0-60mph 6.1 seconds

TOP SPEED 250km/h/155mph limited

COMBINED: From 9.8 l/100km (Up to 28.8 mpg)

CO₂ EMISSIONS: From 234g/km

LUXURY, PREMIUM LUXURY, PORTFOLIO,
AUTOBIOGRAPHY, XJ50, R-SPORT



0-100 KM/H



TOP SPEED KM/H

5.0 LITRE V8¹

SUPERCHARGED PETROL

MAXIMUM POWER 470PS

MAXIMUM TORQUE 575Nm

ACCELERATION 0-100km/h 5.2 seconds,
0-60mph 4.9 seconds

TOP SPEED 250km/h/155mph limited

COMBINED: From 11.1 l/100km (Up to 25.5 mpg)

CO₂ EMISSIONS: From 264g/km

PREMIUM LUXURY, PORTFOLIO



0-100 KM/H



TOP SPEED KM/H

5.0 LITRE V8¹

SUPERCHARGED PETROL

MAXIMUM POWER 510PS

MAXIMUM TORQUE 625Nm

ACCELERATION 0-100km/h 4.9 seconds,
0-60mph 4.7 seconds

TOP SPEED 250km/h/155mph limited

COMBINED: From 11.1 l/100km (Up to 25.5 mpg)

CO₂ EMISSIONS: From 264g/km

AUTOBIOGRAPHY



0-100 KM/H



TOP SPEED KM/H

¹Engine data has not been re-certified in 2018. Data shown conforms to the 2017 NEDC certification. ²The figures provided are as a result of official manufacturer's tests in accordance with EU legislation. For comparison purposes only. Real world figures may differ. CO₂ and fuel economy figures may vary according to wheel fitment and optional extras fitted.

Engine availability is market dependent. Please consult your local Jaguar Retailer for details.

For more information and to configure your vehicle visit jaguar.com

> DIESEL ENGINE

5.0 LITRE V8¹ SUPERCHARGED PETROL

MAXIMUM POWER 575PS
MAXIMUM TORQUE 700Nm
ACCELERATION 0-100km/h 4.4 seconds, 0-60mph 4.2 seconds
TOP SPEED 300km/h/186mph limited
COMBINED: From 11.1 l/100km (Up to 25.5 mpg)
CO ₂ EMISSIONS: From 264g/km
XJR575

3.0 LITRE V6² TURBOCHARGED DIESEL

MAXIMUM POWER 300PS
MAXIMUM TORQUE 700Nm
ACCELERATION 0-100km/h 6.2 seconds, 0-60mph 5.9 seconds
TOP SPEED 250km/h/155mph limited
COMBINED: From 7.0 l/100km (Up to 40.4 mpg)
CO ₂ EMISSIONS: From 184g/km
LUXURY, PREMIUM LUXURY, PORTFOLIO, AUTOBIOGRAPHY, XJ50, R-SPORT



0-100 KM/H

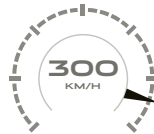

TOP SPEED KM/H



0-100 KM/H



TOP SPEED KM/H

2 CHOOSE YOUR MODEL

 Configure your vehicle at jaguar.com

> LUXURY



LUXURY

KEY FEATURES

- 14-way seats with lumbar adjust
- Heated front and rear seats
- Premium carpet mats
- Navigation Pro
- 10" Touch Pro
- Enhanced Sound System
- Two-zone Climate Control
- Bluetooth® streaming
- Front and Rear Parking Aid
- All Surface Progress Control
- LED headlights
- Power fold exterior mirrors
- Twin oval exhausts
- Chrome grille with Chrome surround
- Chrome side power vent
- Traffic Sign Recognition and Adaptive Speed Limiter



PREMIUM LUXURY

KEY FEATURES (IN ADDITION TO 'LUXURY')

- Heated and cooled front and rear seats
- Soft door close and Keyless Entry
- Soft grain leather seats
- Front headrests with Jaguar leaper embossing



PORTFOLIO

KEY FEATURES (IN ADDITION TO 'PREMIUM LUXURY')

- 18-way seats with lumbar adjust
- Front seat with five massage programmes
- Heated steering wheel
- Meridian™ Sound System
- Four-zone Climate Control
- Automatic High Beam Assist



AUTOBIOGRAPHY

KEY FEATURES (IN ADDITION TO 'PORTFOLIO')

- LED rear reading lights
- Illuminated treadplates
- Metallic foot pedals
- LED headlights with Adaptive Lighting
- 360° Surround Camera
- Park Assist
- 360° Parking Aid
- Blind Spot Assist and Reverse Traffic Detection

> SPORT



XJ50

KEY FEATURES (IN ADDITION TO 'PREMIUM LUXURY')

- Chrome XJ50 side power vents
- XJ50 rear badging
- Illuminated XJ50 branded treadplates
- Exclusive XJ50 intaglio
- XJ50 embossed centre armrest
- Unique 20" 5 split-spoke 'Style 5045' alloy wheels with a Gloss Black Diamond Turned finish
- Gloss Shadow Walnut veneer
- Autobiography front and rear bumper treatment with Black grille mesh
- 18-way seats with lumbar adjust
- Front seat with five massage programmes
- LED headlights with Adaptive Lighting
- Aluminium gearshift paddles
- Metallic foot pedals



R-SPORT

KEY FEATURES (IN ADDITION TO 'PREMIUM LUXURY')

- 18-way seats with lumbar adjust
- Heated steering wheel
- R-Sport front and rear treadplates
- Metallic foot pedals
- Meridian™ Sound System
- Four-zone Climate Control
- Gloss Black front grille and rear valance
- Rear spoiler, side sills and front splitter
- Suedecloth headlining



XJR575

KEY FEATURES (IN ADDITION TO 'R-SPORT')

- XJR575 treadplates
- Meridian™ Surround Sound System
- Full LED headlights with Adaptive Lighting and Automatic High Beam Assist
- Gloss Black grille with Gloss Black surround
- Gloss Black side window surround
- Gloss Black side power vents
- Red painted brake calipers with Jaguar script
- XJR575 bonnet louvres
- Body-coloured rear valance with Gloss Black insert
- Unique Sports Exhaust with quad pipes
- LED rear reading light
- Electric rear blind
- Aluminium gearshift paddles

Images feature optional equipment.
Please note that standard features may be replaced when selecting alternative trim levels.
Standard features may also vary depending on country of purchase, engine variant and transmission.
Standard and optional features may differ depending on market availability. Please consult your local Jaguar Retailer for details.

3 CHOOSE YOUR COLOUR

 [Configure your vehicle at jaguar.com](https://www.jaguar.com)

SOLID

Fuji White

Narvik Black

METALLIC

Yulong White

Indus Silver

Corris Grey

Loire Blue

Rosello Red

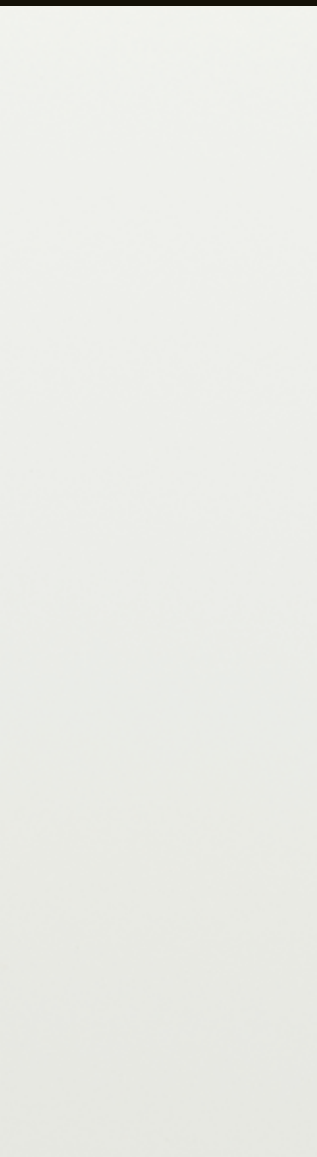

Firenze Red



British Racing Green



Santorini Black

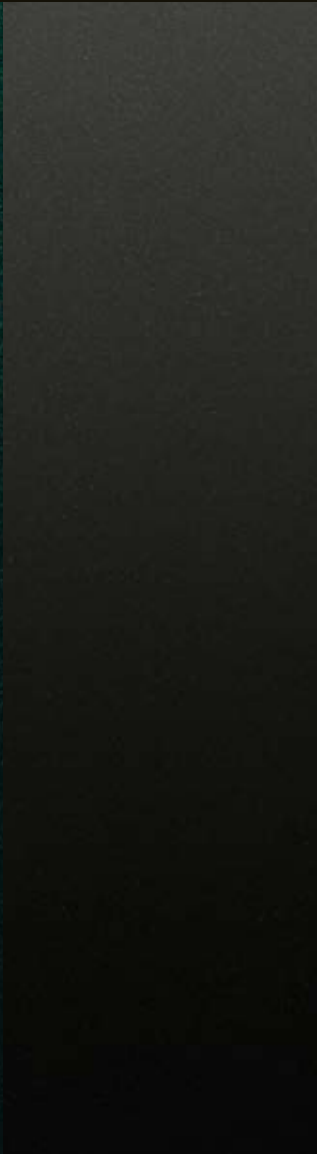

PREMIUM METALLIC

Carpathian Grey



Farallon Black



SVO PREMIUM PALETTE

Velocity Blue

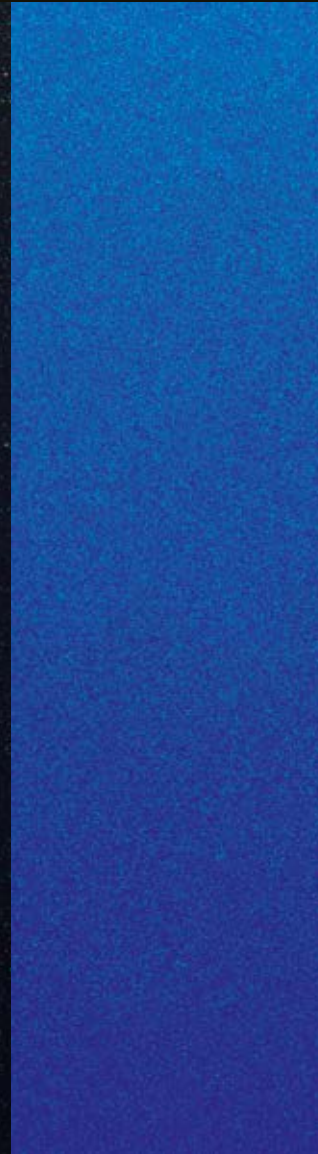

Satin Corris Grey



4 CHOOSE YOUR WHEELS

 Configure your vehicle at jaguar.com



18" 15 SPOKE
'STYLE 1031'

Sparkle Silver

8.0J x 18" / 9.0J x 18"

245/50ZR18 / 275/45ZR18

031HA



18" 10 SPOKE
'STYLE 1030'

Sparkle Silver

8.0J x 18" / 9.0J x 18"

245/50ZR18 / 275/45ZR18

031GP



19" 10 SPOKE
'STYLE 1028'

Sparkle Silver

9.0J x 19" / 10.0J x 19"

245/45ZR19 / 275/40ZR19

031GN

ALLOY WHEEL FINISH

ALLOY WHEEL / SIZE

TYRE SIZE

CODE



19" 5 SPLIT-SPOKE
'STYLE 5043'

Sparkle Silver

9.0J x 19" / 10.0J x 19"

245/45ZR19 / 275/40ZR19

031HC



19" 7 SPLIT-SPOKE
'STYLE 7016'

Sparkle Silver

9.0J x 19" / 10.0J x 19"

245/45ZR19 / 275/40ZR19

031GT



20" 8 SPLIT-SPOKE
'STYLE 8001'

Silver

9.0J x 20" / 10.0J x 20"

245/40ZR20 / 275/35ZR20

031GI

ALLOY WHEEL FINISH

ALLOY WHEEL / SIZE

TYRE SIZE

CODE

Standard and optional features may differ depending on market availability. Please consult your local Jaguar Retailer for details.



20" 8 SPLIT-SPOKE
'STYLE 8001'



20" 10 SPLIT-SPOKE
'STYLE 1029'



20" 5 SPLIT-SPOKE
'STYLE 5063'



20" 10 SPLIT-SPOKE
'STYLE 1010'

ALLOY WHEEL FINISH	Polished	High Gloss Silver	Satin Grey	Satin Grey Diamond Turned
ALLOY WHEEL / SIZE	9.0J x 20" / 10.0J x 20"	9.0J x 20" / 10.0J x 20"	9.0J x 20" / 10.0J x 20"	9.0J x 20" / 10.0J x 20"
TYRE SIZE	245/40ZR20 / 275/35ZR20	245/40ZR20 / 275/35ZR20	245/40ZR20 / 275/35ZR20	245/40ZR20 / 275/35ZR20
CODE	031GL	031GO	031RA	031GQ



20" 5 SPLIT-SPOKE
'STYLE 5045'



20" 5 SPLIT-SPOKE
'STYLE 5045'



20" 5 SPLIT-SPOKE
'STYLE 5044'



20" 5 SPLIT-SPOKE
'STYLE 5044'

ALLOY WHEEL FINISH	Gloss Black Diamond Turned	Diamond Turned	Technical Grey	Gloss Black
ALLOY WHEEL / SIZE	9.0J x 20" / 10.0J x 20"	9.0J x 20" / 10.0J x 20"	9.0J x 20" / 10.0J x 20"	9.0J x 20" / 10.0J x 20"
TYRE SIZE	245/40ZR20 / 275/35ZR20	245/40ZR20 / 275/35ZR20	265/35R20 / 295/30R20	265/35R20 / 295/30R20
CODE	031QZ	031GS	031GW	031GV

5 CHOOSE YOUR INTERIOR

 Configure your vehicle at jaguar.com

LUXURY							
	SEAT BOND GRAIN LEATHER WITH STITCH	VENEER	MORZINE HEADLINING	UPPER FACIA BOND GRAIN LEATHER	LOWER FACIA	CARPET	INTERIOR TRIM AND OPTION CODES
Standard							
	Cashew/Cashew	Gloss Rich Oak	Ivory	Truffle	Cashew	Truffle	TXN
	Ebony/Ebony	Gloss Rich Oak	Ivory	Ebony	Ebony	Ebony	SAW
PREMIUM LUXURY							
	SEAT SOFT GRAIN PERFORATED LEATHER WITH STITCH/PIPING	VENEER	MORZINE HEADLINING	UPPER FACIA SOFT FEEL	LOWER FACIA	CARPET	INTERIOR TRIM AND OPTION CODES
Standard							
	Ivory/Mineral/Mineral*	Gloss Rich Oak	Ivory	Mineral	Ivory	Mineral	SCT
	Cashew/Truffle/Truffle	Gloss Rich Oak	Ivory	Truffle	Cashew	Truffle	SAZ
	London Tan/Ebony/Ebony	Gloss Rich Oak	Ivory	Ebony	Ebony	Ebony	SAD
	Ebony/Ivory/Ivory	Gloss Rich Oak	Ivory	Ebony	Ebony	Ebony	TXQ
PORTFOLIO							
	SEAT SOFT GRAIN QUILTED AND PERFORATED LEATHER WITH STITCH	VENEER	PREMIUM SUEDECLOTH HEADLINING	UPPER FACIA SOFT GRAIN LEATHER	LOWER FACIA	CARPET	INTERIOR TRIM AND OPTION CODES
Standard							
	Ebony/Ivory	Gloss Figured Ebony	Ivory or Ebony	Ebony	Ebony	Ebony	TXS
	London Tan/Ebony	Gloss Figured Ebony	Ivory or Ebony	Ebony	London Tan	Ebony	SAF
	Cashew/Truffle	Gloss Figured Ebony	Ivory	Truffle	Cashew	Truffle	SBB
	Ivory/Mineral	Gloss Figured Ebony	Ivory	Mineral	Ivory	Mineral	SCU
	Ivory/Ebony	Gloss Figured Ebony	Ivory or Ebony	Ebony	Ivory	Ebony	TXH

*Requires heated steering wheel.

Standard and optional features may differ depending on market availability. Please consult your local Jaguar Retailer for details.

AUTOBIOGRAPHY							
	SEAT SEMI-ANILINE QUILTED AND PERFORATED LEATHER WITH STITCH	VENEER	SOFT GRAIN LEATHER HEADLINING	UPPER FACIA SOFT GRAIN LEATHER	LOWER FACIA	CARPET	INTERIOR TRIM AND OPTION CODES
Standard							
	Ivory/Mineral	Gloss Rich Oak with Linear Laser Inlay	Ivory	Mineral	Ivory	Mineral	SAK
	Ivory/Ebony	Gloss Rich Oak with Linear Laser Inlay	Ivory or Ebony	Ebony	Ivory	Ebony	TXG
	Cashew/Truffle	Gloss Rich Oak with Linear Laser Inlay	Ivory	Truffle	Cashew	Truffle	SBA
	London Tan/Ebony	Gloss Rich Oak with Linear Laser Inlay	Ivory or Ebony	Ebony	London Tan	Ebony	SAE
	Ebony/Ivory	Gloss Rich Oak with Linear Laser Inlay	Ivory or Ebony	Ebony	Ebony	Ebony	TXR
XJ50							
	SEAT SOFT GRAIN QUILTED AND PERFORATED LEATHER WITH STITCH	VENEER	MORZINE HEADLINING	UPPER FACIA SOFT GRAIN LEATHER	LOWER FACIA	CARPET	INTERIOR TRIM AND OPTION CODES
Standard							
	Ivory/Ebony	Gloss Shadow Walnut	Ivory	Ebony	Ivory	Ebony	SHK
	Ebony/Ivory	Gloss Shadow Walnut	Ivory	Ebony	Ebony	Ebony	SHJ
R-SPORT							
	SEAT SOFT GRAIN PERFORATED LEATHER WITH STITCH	VENEER	PREMIUM SUEDECLOTH HEADLINING	UPPER FACIA SOFT GRAIN LEATHER	LOWER FACIA	CARPET	INTERIOR TRIM AND OPTION CODES
Standard							
	Ebony/Pimento	Piano Black	Ivory or Ebony	Ebony	Ebony	Ebony	TXW
	Ivory/Ebony	Piano Black	Ivory or Ebony	Ebony	Ivory	Ebony	TXI
	Ebony/Pimento duo tone/Pimento	Piano Black	Ivory or Ebony	Ebony	Ebony	Ebony	SCV
XJR575							
	SEAT SOFT GRAIN PERFORATED LEATHER WITH STITCH	VENEER	PREMIUM SUEDECLOTH HEADLINING	UPPER FACIA SOFT GRAIN LEATHER	LOWER FACIA	CARPET	INTERIOR TRIM AND OPTION CODES
Standard							
	Ebony/Pimento	Carbon Fibre	Ebony or Ivory	Ebony	Ebony	Ebony	TXT
	Ivory/Ebony	Carbon Fibre	Ebony or Ivory	Ebony	Ivory	Ebony	TXE

5 CHOOSE YOUR INTERIOR

Configure your vehicle at jaguar.com









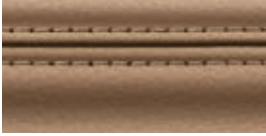

Interior shown: Cashew Bond grain leather seats with Truffle upper facia, Ivory Morzine headlining, Gloss Rich Oak veneer and Truffle carpet.



LUXURY

INTERIOR COLOUR COMBINATIONS

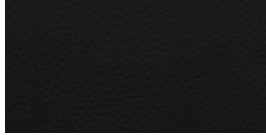
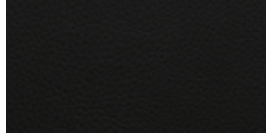
STANDARD - BOND GRAIN LEATHER SEAT

①	②	③	④	⑤	⑥
SEAT WITH TONAL STITCH	VENEER	MORZINE HEADLINING	UPPER FACIA	LOWER FACIA	CARPET
					
Cashew with Cashew stitch	Gloss Rich Oak	Ivory	Truffle	Cashew	Truffle
					
Ebony with Ebony stitch	Gloss Rich Oak	Ivory	Ebony	Ebony	Ebony

VENEER OPTIONS

Piano Black, Carbon Fibre, Gloss Figured Ebony, Gloss Rich Oak with Linear Laser Inlay or Gloss Burr Walnut

5 CHOOSE YOUR INTERIOR













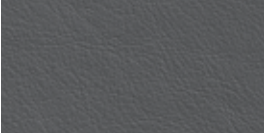









⚙️ Configure your vehicle at jaguar.com

Interior shown: Ivory soft grain leather seats with Mineral upper facia, Ivory Morzine headlining, Gloss Rich Oak veneer and Mineral carpet.



PREMIUM LUXURY INTERIOR COLOUR COMBINATIONS

STANDARD - SOFT GRAIN LEATHER SEAT

1	2	3	4	5	6
SEAT WITH CONTRAST STITCH AND PIPING	VENEER	MORZINE HEADLINING	UPPER FACIA	LOWER FACIA	CARPET
					
Ivory with Mineral stitch*	Gloss Rich Oak	Ivory	Mineral	Ivory	Mineral
					
Cashew with Truffle stitch	Gloss Rich Oak	Ivory	Truffle	Cashew	Truffle
					
London Tan with Ebony stitch	Gloss Rich Oak	Ivory	Ebony	Ebony	Ebony
					
Ebony with Ivory stitch	Gloss Rich Oak	Ivory	Ebony	Ebony	Ebony

VENEER OPTIONS

Piano Black, Carbon Fibre, Gloss Figured Ebony, Gloss Rich Oak with Linear Laser Inlay or Gloss Burr Walnut

*Requires heated steering wheel.

5 CHOOSE YOUR INTERIOR

⚙️ Configure your vehicle at jaguar.com

Interior shown: Ebony soft grain perforated quilted leather seats with Ivory contrast stitch, Ebony upper fascia, Ivory suedecloth headlining, Gloss Figured Ebony veneer and Ebony carpet.

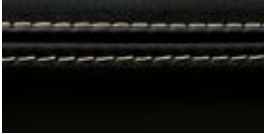























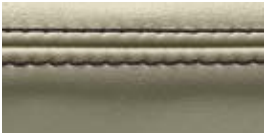

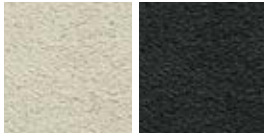



Image shown includes Rear Seat Entertainment.



PORTFOLIO

INTERIOR COLOUR COMBINATIONS

STANDARD - SOFT GRAIN LEATHER SEAT

1	2	3	4	5	6
SEAT WITH CONTRAST STITCH	VENEER	SUEDECLOTH HEADLINING	UPPER FACIA	LOWER FACIA	CARPET
					
Ebony with Ivory stitch	Gloss Figured Ebony	Ivory or Ebony	Ebony	Ebony	Ebony
					
London Tan with Ebony stitch	Gloss Figured Ebony	Ivory or Ebony	Ebony	London Tan	Ebony
					
Cashew with Truffle stitch	Gloss Figured Ebony	Ivory	Truffle	Cashew	Truffle
					
Ivory with Mineral stitch	Gloss Figured Ebony	Ivory	Mineral	Ivory	Mineral
					
Ivory with Ebony stitch	Gloss Figured Ebony	Ivory or Ebony	Ebony	Ivory	Ebony

VENEER OPTIONS

Piano Black, Carbon Fibre, Gloss Rich Oak, Gloss Rich Oak with Linear Laser Inlay or Gloss Burr Walnut

5 CHOOSE YOUR INTERIOR

⚙️ Configure your vehicle at [jaguar.com](https://www.jaguar.com)

Interior shown: Ivory Semi-Aniline perforated quilted leather seats with Mineral contrast stitch, Mineral upper facia, Ivory leather headlining and Gloss Rich Oak with Linear Laser Inlay veneer and Mineral carpet.



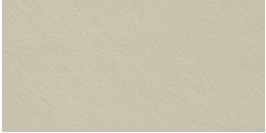
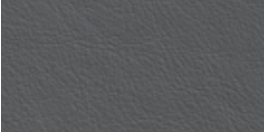



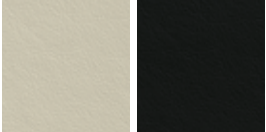











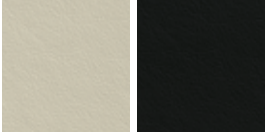





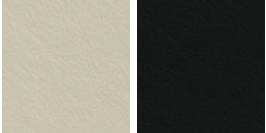



Image shown includes Rear Seat Entertainment.



AUTOBIOGRAPHY

INTERIOR COLOUR COMBINATIONS

STANDARD - SEMI-ANILINE LEATHER SEAT

1	2	3	4	5	6
SEAT WITH CONTRAST STITCH	VENEER	LEATHER HEADLINING	UPPER FACIA	LOWER FACIA	CARPET
 Ivory with Mineral stitch	 Gloss Rich Oak with Linear Laser Inlay	 Ivory	 Mineral	 Ivory	 Mineral
 Ivory with Ebony stitch	 Gloss Rich Oak with Linear Laser Inlay	 Ivory or Ebony	 Ebony	 Ivory	 Ebony
 Cashew with Truffle stitch	 Gloss Rich Oak with Linear Laser Inlay	 Ivory	 Truffle	 Cashew	 Truffle
 London Tan with Ebony stitch	 Gloss Rich Oak with Linear Laser Inlay	 Ivory or Ebony	 Ebony	 London Tan	 Ebony
 Ebony with Ivory stitch	 Gloss Rich Oak with Linear Laser Inlay	 Ivory or Ebony	 Ebony	 Ebony	 Ebony

VENEER OPTIONS

Piano Black, Carbon Fibre, Gloss Rich Oak, Gloss Figured Ebony or Gloss Burr Walnut

5 CHOOSE YOUR INTERIOR

Configure your vehicle at jaguar.com

Interior shown: Ivory soft grain perforated quilted leather seats with Ebony contrast stitch, Ebony upper fascia, Ivory Morzine headlining, Gloss Shadow Walnut veneer and Ebony carpet.



XJ50

INTERIOR COLOUR COMBINATIONS

STANDARD - SOFT GRAIN LEATHER SEAT

1

LEATHER SEAT WITH
CONTRAST STITCH

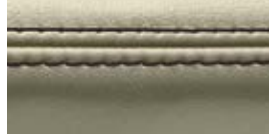

Ivory with Ebony stitch

2

VENEER



Gloss Shadow Walnut

3

MORZINE HEADLINING



Ivory

4

UPPER FACIA



Ebony

5

LOWER FACIA



Ivory

6

CARPET



Ebony

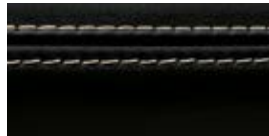

Ebony with Ivory stitch



Gloss Shadow Walnut



Ivory



Ebony



Ebony



Ebony

5 CHOOSE YOUR INTERIOR

Configure your vehicle at jaguar.com











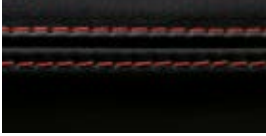





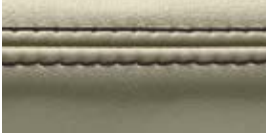

Interior shown: Ebony soft grain leather sport seats with Pimento contrast stitch, Ebony upper fascia, Ivory suedecloth headlining, Piano Black veneer and Ebony carpet.

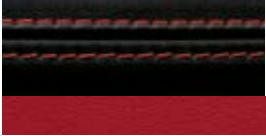

R-SPORT

INTERIOR COLOUR COMBINATIONS

STANDARD - SOFT GRAIN LEATHER SEAT

1	2	3	4	5	6
<p>LEATHER SEAT WITH CONTRAST STITCH</p>  <p>Ebony with Pimento stitch</p>	<p>VENEER</p>  <p>Piano Black</p>	<p>SUEDECLOTH HEADLINING</p>  <p>Ivory or Ebony</p>	<p>UPPER FACIA</p>  <p>Ebony</p>	<p>LOWER FACIA</p>  <p>Ebony</p>	<p>CARPET</p>  <p>Ebony</p>
 <p>Ivory with Ebony stitch</p>	 <p>Piano Black</p>	 <p>Ivory or Ebony</p>	 <p>Ebony</p>	 <p>Ivory</p>	 <p>Ebony</p>
 <p>Ebony/Pimento Duo Tone/Pimento</p>	 <p>Piano Black</p>	 <p>Ivory or Ebony</p>	 <p>Ebony</p>	 <p>Ebony</p>	 <p>Ebony</p>

VENEER OPTION

Carbon Fibre

5 CHOOSE YOUR INTERIOR

⚙️ Configure your vehicle at jaguar.com

Interior shown: Ebony soft grain perforated quilted leather sport seats with Pimento contrast stitch, Ebony upper fascia, Ebony suedecloth headlining, Carbon Fibre veneer and Ebony carpet.



XJR575

INTERIOR COLOUR COMBINATIONS

STANDARD - SOFT GRAIN LEATHER SEAT

1

LEATHER SEAT WITH
CONTRAST STITCH

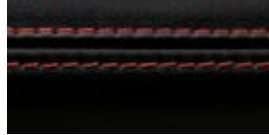

Ebony with Pimento stitch

2

VENEER



Carbon Fibre

3

SUEDECLOTH HEADLINING



Ebony or Ivory

4

UPPER FACIA



Ebony

5

LOWER FACIA



Ebony

6

CARPET



Ebony



Ivory with Ebony stitch



Carbon Fibre



Ebony or Ivory



Ebony



Ivory



Ebony

VENEER OPTION

Piano Black

5 CHOOSE YOUR INTERIOR

 Configure your vehicle at jaguar.com

Piano Black

Carbon Fibre

Gloss Rich Oak

Gloss Figured Ebony



Gloss Rich Oak with Linear Laser Inlay



Gloss Burr Walnut



Gloss Shadow Walnut



6 CHOOSE YOUR JAGUAR GEAR - ACCESSORIES

To find out more about the full range of Retailer fit Jaguar Gear - Accessories, please refer to your Retailer or go to gear.jaguar.com



Chrome Mirror Cover
C2D5489 - Left
C2D5488 - Right

Chrome mirror covers accentuate the stylish design of the exterior mirrors. Left and right side options available.

*Not compatible with Rear Seat Entertainment.

Availability is market dependent. Please consult your local Jaguar Retailer for details.



Splash Guards
C2D8498 - Front
C2D8499 - Rear

Jaguar branded front splash guards complement the lines of your vehicle, reduce spray and provide protection from dirt and stone chippings.



Click and Hang*
J9C2167

The Click and Hang is part of the Click and Go range. This removable coat hanger allows shirts or jackets to be kept crease-free whilst transporting. Also includes an integral hook for use outside the vehicle.



Aluminium Gearshift Paddles
T2R6547MMU

Replacement steering wheel gearshift paddles offered in a Premium aluminium material providing a high quality finish to a key contact point in the vehicle. Manufactured from billet machined aluminium, the paddles are hand brushed for a Premium finish and anodised to ensure they will not deteriorate with wear.



Illuminated Treadplate

Elegantly styled aluminium sill treadplates illuminate when the driver or passenger doors are opened. Highlighted by soft Phosphor Blue lighting. Please consult your authorised Jaguar Retailer for ordering information.



Click and Play*
J9C2164

The Click and Play iPad 2 - 4 holder is part of the Click and Go range. This removable tablet holder attachment can easily be positioned at multiple angles for in-cabin comfort and rear entertainment.



Premium Loadspace Mat
C2D7450

Luxurious soft luggage mat in Ebony Black with the Jaguar logo. Deep premium 2,050g/m² pile with nubuck edging and Dove contrast stitch.

TECHNICAL SPECIFICATIONS

 Configure your vehicle at jaguar.com

ENGINES		JAGUAR 3.0 LITRE V6 300 TURBOCHARGED DIESEL ¹	JAGUAR 3.0 LITRE V6 340 SUPERCHARGED PETROL ²
Drive		RWD	RWD
Capacity	cc	2993	2995
Maximum power	EEC-PS (kW)	300 (221)	340 (250)
@rev/min		4,000	6,500
Maximum torque	EEC-Nm (lb.ft.)	700 (516)	450 (332)
@rev/min		2,000	3,500-5,000
Transmission		8-speed Automatic	8-speed Automatic
PERFORMANCE			
0-100 km/h	seconds	6.2	5.9
0-60 mph	seconds	5.9	5.7
Top speed	km/h (mph)	250 (155) limited	250 (155) limited
FUEL CONSUMPTION - STANDARD WHEELBASE			
Combined	l/100km (mpg)	From 7.0 (Up to 40.4)	From 9.1 (31.0)
Carbon dioxide emissions	g/km	From 184	From 211
Tank capacity (usable)	ltr approx.	77	80
FUEL CONSUMPTION - LONG WHEELBASE			
Combined	l/100km (mpg)	From 7.0 (Up to 40.4)	From 9.1 (31.0)
Carbon dioxide emissions	g/km	From 185	From 211
Tank capacity	ltr approx.	77	80

¹The figures provided are as a result of official manufacturer's tests in accordance with EU legislation. For comparison purposes only. Real world figures may differ. CO₂ and fuel economy figures may vary according to wheel fitment and optional extras fitted. ²Engine data has not been re-certified in 2019. Data shown conforms to the 2017 NEDC certification.

Engine availability is market dependent. Please consult your local Jaguar Retailer for details.

For more information and to configure your vehicle visit jaguar.com

JAGUAR 3.0 LITRE V6 340 SUPERCHARGED PETROL ²	JAGUAR 5.0 LITRE V8 470 SUPERCHARGED PETROL ²	JAGUAR 5.0 LITRE V8 510 SUPERCHARGED PETROL ²	JAGUAR 5.0 LITRE V8 575 SUPERCHARGED PETROL ²
AWD	RWD	RWD	RWD
2995	5000	5000	5000
340 (250)	470 (346)	510 (375)	575 (423)
6,500	6,000-6,500	6,000-6,500	6,250-6,500
450 (332)	575 (424)	625 (461)	700 (517)
3,500-5,000	2,000-5,500	2,500-5,500	3,500-4,500
8-speed Automatic	8-speed Automatic	8-speed Automatic	8-speed Automatic
6.4	5.2	4.9	4.4
6.1	4.9	4.7	4.2
250 (155) limited	250 (150) limited	250 (155) limited	300 (186) limited
From 9.8 (28.8)	From 11.1 (25.5)	From 11.1 (25.5)	From 11.1 (25.5)
From 234	From 264	From 264	From 264
80	80	80	80
From 9.8 (28.8)	From 11.1 (25.5)	From 11.1 (25.5)	From 11.1 (25.5)
From 234	From 264	From 264	From 264
80	80	80	80

TECHNICAL SPECIFICATIONS

 Configure your vehicle at jaguar.com



VEHICLE SHOWN: XJ PORTFOLIO LONG WHEELBASE WITH OPTIONAL FEATURES FITTED (MARKET DEPENDENT)

STANDARD WHEELBASE		JAGUAR 3.0 LITRE V6 300 TURBOCHARGED DIESEL	JAGUAR 3.0 LITRE V6 340 SUPERCHARGED PETROL	JAGUAR 5.0 LITRE V8 510 SUPERCHARGED PETROL	JAGUAR 5.0 LITRE V8 575 SUPERCHARGED PETROL
Drive		RWD	RWD	AWD	RWD
Overall length	mm	5,130	5,130	5,130	5,130
Overall width (inc./with folded mirrors)	mm	2,105/1,950	2,105/1,950	2,105/1,950	2,105/1,950
Overall height (inc. antenna)	mm	1,460	1,460	1,460	1,460
Wheelbase	mm	3,032	3,032	3,032	3,032
Front/Rear track	mm	1,626/1,604	1,626/1,604	1,626/1,604	1,626/1,604
Turning circle (wall-to-wall)	m (ft.in)	12.1 (39.7)	12.1 (39.7)	12.6 (41.3)	12.1 (39.7)
Boot volume with Tyre Repair System	litres - VDA	478	478	478	478
Front/Rear legroom	mm	1,055/988	1,055/988	1,055/988	1,055/988
Headroom with sunroof (front)	mm	1,004	1,004	1,004	1,004
Headroom (rear)	mm	945	945	945	945
Front/Rear shoulder room	mm	1,464/1,437	1,464/1,437	1,464/1,437	1,464/1,437
Weight*	kg (lbs)	1,835 (4,045)	1,765 (3,891)	1,865 (4,112)	1,875 (4,134)
Gross vehicle weight*	kg (lbs)	2,400 (5,291)	2,350 (5,181)	2,430 (5,357)	2,400 (5,291)
LONG WHEELBASE					
Overall length	mm	5,255	5,255	5,255	5,255
Overall width (inc./with folded mirrors)	mm	2,105/1,950	2,105/1,950	2,105/1,950	2,105/1,950
Overall height (inc. antenna)	mm	1,460	1,460	1,460	1,460
Wheelbase	mm	3,157	3,157	3,157	3,157
Front/Rear track	mm	1,626/1,604	1,626/1,604	1,626/1,604	1,626/1,604
Turning circle (wall-to-wall)	m (ft.in)	12.5 (41.0)	12.5 (41.0)	13.1 (43.0)	12.5 (41.0)
Boot volume with Tyre Repair System	litres - VDA (cu.ft.)	478	478	478	478
Front/Rear legroom	mm	1,055/1,109	1,055/1,109	1,055/1,109	1,055/1,109
Rear legroom with Rear Seat Package (rear seat fully upright)	mm	1,109	1,109	1,109	1,109
Rear legroom with Rear Seat Package (rear seat fully reclined)	mm	1,021	1,021	1,021	1,021
Rear legroom with Premium Rear Seat Package (rear seat fully upright)	mm	1,087	1,087	1,087	1,087
Rear legroom with Premium Rear Seat Package (rear seat fully reclined)	mm	989	989	989	989
Headroom with sunroof (front)	mm	1,004	1,004	1,004	1,004
Headroom (rear)	mm	946	946	946	946
Front/Rear shoulder room	mm	1,464/1,437	1,464/1,437	1,464/1,437	1,464/1,437
Weight*	kg (lbs)	1,860 (4,101)	1,775 (3,913)	1,875 (4,134)	1,885 (4,156)
Gross vehicle weight*	kg (lbs)	2,450 (5,401)	2,400 (5,291)	2,450 (5,401)	2,450 (5,401)

*Weights reflect vehicles to standard specifications. Optional extras increase weight.

Engine availability is market dependent. Please consult your local Jaguar Retailer for details.

Dimensions were measured with vehicle at unladen weight.

Boot volume measured by VDA standard test method using 200 x 100 x 50mm blocks.

For more information and to configure your vehicle visit jaguar.com

SPECIAL VEHICLE OPERATIONS



Special Vehicle Operations (SVO) designs and engineers products that amplify Jaguar and Land Rover core brand values; focusing on luxury, performance and capability.

Our team of specialists is completely focused on enhancing and personalising our relationship with our most discerning and enthusiastic customers – delivering experiences that our customers will love for life.

SVO is responsible for the creation of a suite of halo products that showcase the pinnacle of Jaguar design and engineering capabilities, enabling our customers to indulge their passion for spectacular new vehicles.

THE NEW SVO TECHNICAL CENTRE

In the heart of the British Midlands is SVO's brand new Technical Centre. This state-of-the-art facility represents a £20m investment by Jaguar Land Rover, and features four zones designed to support the creation of truly breathtaking vehicles. In addition to the Commissioning and Presentation suites, our manufacturing centre is responsible for the assembly and hand-finishing of SVO halo and Collector's Edition vehicles, and a world-class paint facility ensures an exquisite finish for every car we create.

BESPOKE BY SVO

Bespoke by SVO was born out of an innate understanding of what our most discerning clients value more than anything else – to own something completely unique to them. Something only they can have, reflecting who they are and what they hold most dear. With that in mind, SVO developed innovative Commissioning and Presentation suites enabling creation of the most refined and luxurious vehicles in the world. This special new facility is housed within the new SVO Technical Centre in Warwickshire, England.





THE WORLD OF JAGUAR

Choose XJ and you're joining the exciting World of Jaguar.

TRACK DAYS

There's no better way to get to know Jaguar than by taking a drive. The Jaguar Experience offers a range of unique opportunities to really find out what it feels like to get the most out of a Jaguar. Our track experiences allow you to push yourself and cars from the incredible Jaguar range to the limit.

Find out more by visiting jaguar.com/experience

BEHIND THE SCENES

Our factory tours give you the unique opportunity to experience the whole process of how our cars are brought to life – from the moulding of sheet metal to those intricate final touches. At our state-of-the-art production facilities, you'll get to see how skilled technicians and sophisticated machines work seamlessly together to perfect some of Jaguar's most breathtaking cars.

Find out more at jaguar.com/experience-jaguar/behind-the-scenes

ICE DRIVE EXPERIENCES

Take your driving to the next level with the Jaguar Land Rover Ice Drive Experience. Since 2017, we have been offering an adventure in Arjeplog, Sweden, that will test and develop your performance driving skills in extreme conditions. It's a rare chance for owners and enthusiasts to tackle some of the harshest and most challenging tracks on earth, under the skilled guidance of our experts. Our driving instructors are of the highest calibre and will be with you every step of the way – ready to impart years of driving wisdom. You will dance on ice, glide around some of the most awe-inspiring corners imaginable and realise the true exhilarating potential of Jaguar and Land Rover.

If you'd like to be part of the next adventure, find out more by visiting jaguar.com/experience-jaguar/iconic-experiences





FORMULA E

Jaguar's reputation for performance, technology and design was forged by the world's most challenging circuits and championships. From Le Mans to Formula 1, and now Formula E, the grid is our test-bed. Formula E provides the perfect proving ground for electric vehicle technology in a high performance environment. The racing series accelerates the development of Jaguar's electric powertrains. With every race, Formula E helps Jaguar engineers create better electric vehicles.

Find out more by visiting jaguar.com/jaguar-racing

JAGUAR COLLECTION

The latest range from the Jaguar Collection has been crafted with the same design execution and attention to detail that goes into all of our cars. This is evident in our clothing range, premium leather items and luxury travel goods. To celebrate Jaguar's heritage, we also have a collection that honours past achievements and features race inspired gift items and apparel.

To find out more, visit the online shop at www.jaguar.com/shop

THE JAGUAR MAGAZINE

This is our own vibrant, cosmopolitan and contemporary magazine. Produced by a team of enthusiastic designers and feature writers, it goes behind the scenes at Jaguar as well as providing insight into the world of luxury, design, style and travel. You can enjoy Jaguar Magazine twice a year completely free of charge for the first three years. Ask your local Jaguar Retailer to ensure that you receive your copy.

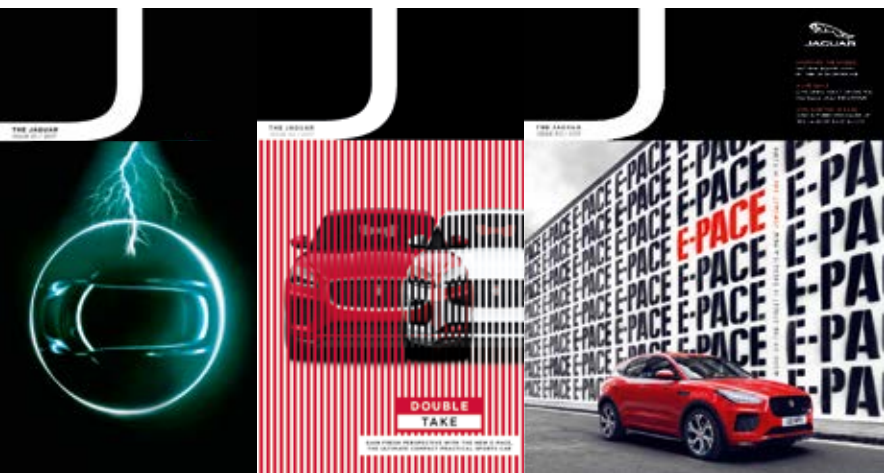



AT YOUR SERVICE

As well as providing a range of exclusive services and lifestyle products, the World of Jaguar makes owning and driving carefree and easy.

GENUINE PARTS

Jaguar Genuine Parts are designed, tested and manufactured to our uncompromising standards for quality, fit and durability. Each part is engineered specifically for your XJ to contribute to optimum performance and to help maximise its lifespan.

FLEET & BUSINESS

Jaguars are dynamic and distinctive cars that help companies express the unique character and personality of their business. We are committed to providing customer-focused aftersales services, ensuring that every Jaguar performs to the highest standard and in the most cost-efficient way for businesses.

Visit jaguar.com/fleet-and-business for more information.

JAGUAR ASSISTANCE

Jaguar Assistance provides assistance in motoring emergencies, from immobilisation due to breakdown or accident to minor problems such as punctures. You can rely on our roadside assistance, whatever the situation, wherever you happen to be.

JAGUAR FINANCIAL SERVICES

New or used, for personal or business use, we have a finance option that puts you in complete control. Please speak to your local Jaguar Retailer to find out more.

INSURANCE

XJ's key components are easily accessible for time-efficient service and repair costs. With a focus on lower repair costs, XJ delivers competitive insurance group ratings. To find out more about the compelling business case for XJ, please contact your local Jaguar Retailer.

IMPORTANT NOTICE

Jaguar Land Rover Limited is constantly seeking ways to improve the specification, design and production of its vehicles, parts and accessories and alterations take place continually. Whilst every effort is made to produce up to date literature, this brochure should not be regarded as an infallible guide to current specifications or availability, nor does it constitute an offer for the sale of any particular vehicle, part or accessory. Distributors and retailers are not agents of Jaguar Land Rover Limited by any express or implied undertaking or representation.

COLOURS

The colours reproduced here are subject to the limitations of the printing process and may therefore vary slightly from the actual vehicle. The company reserves the right to alter or withdraw any colour finish without notice. Some of these colours may not be obtainable in your country. Please check availability of colours and current specifications with your Jaguar Retailer. Distributors and retailers are not agents of Jaguar Land Rover Limited and have absolutely no authority to bind Jaguar Land Rover Limited to any express or implied undertaking or representation.

ENVIRONMENTAL INNOVATION AT JAGUAR

Jaguar is committed to reducing dependency on fossil fuels, using fewer natural resources and creating less waste as part of our approach to responsible and sustainable business development.

Search 'Jaguar Environmental Innovation' for more details.

Meridian is the registered trademark of Meridian Audio Ltd.

AdBlue® is the registered trademark of the Verband der Automobilindustrie e. V. (VDA)

The Bluetooth® word mark and logos are owned by the Bluetooth SIG, Inc. and any use of such marks by Jaguar Land Rover Limited is under license.

iPod, iPod touch and iPad are trademarks of Apple Inc, registered in the US and other countries.

The navigation system must always be used in conditions that will not affect the driver's ability to drive safely or affect the safety of other road users.

Celeron, Centrino, Intel, the Intel logo, Intel Atom, Intel Core, Intel Inside, the Intel Inside logo, Intel vPro, Intel Xeon Phi, Itanium, Pentium, and Xeon are trademarks of Intel Corporation in the U.S and/or other countries.

Trifield and the "three fields" device is a trademark of Trifield Productions Ltd.

VEHICLE SHOWN: XJ PORTFOLIO LONG WHEELBASE IN CARPATHIAN GREY WITH OPTIONAL FEATURES FITTED (MARKET DEPENDENT)

VEHICLE SHOWN FRONT AND BACK COVER: XJ50 LONG WHEELBASE IN LOIRE BLUE WITH OPTIONAL FEATURES FITTED (MARKET DEPENDENT)

Jaguar Land Rover Limited
Registered Office: Abbey Road, Whitley,
Coventry, CV3 4LF, United Kingdom

Registered in England Number: 1672070

jaguar.com

© Copyright Jaguar Land Rover Limited 2019

1X3511910000BXXEN01P

