

NUPS12 and NUPS24 – Basic Battery Charger and DC UPS Module

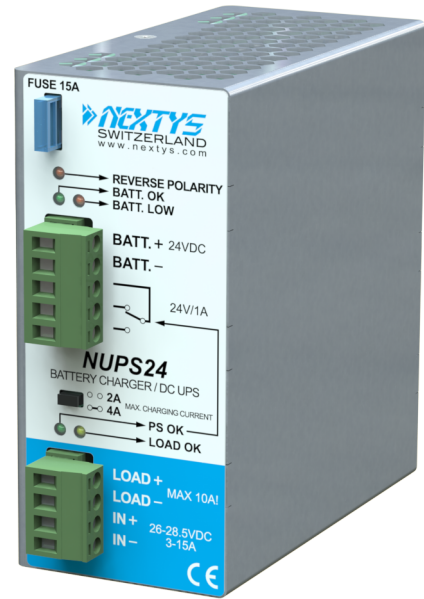



■ **Main Features:**

- Low cost DC-UPS with charging of a 12 or 24 Vdc battery
- Suitable for power supplies with adjustable output
- Allows to feed the load and to charge the battery simultaneously
- Built-it battery overcurrent protection fuse
- Battery deep discharge protection
- To be used with lead acid and lithium batteries (compatible with lead acid batteries)
- Instantaneous LOAD switch to BACKUP mode



INDEX	
Installation Requirements	Page 2
Declaration of Conformity	2
User Instructions	3
Connections	4
Dimensions	4
Distances	4
Mounting	4
Dismounting	5
Input Connections	5
Environment	5
Accessory Device	5

READ THIS CAREFULLY BEFORE INSTALLATION!	LEGGERE ATTENTAMENTE PRIMA DELL'INSTALLAZIONE!	A LIRE ATTENTIVEMENT AVANT L'INSTALLATION!
<p>Before operating, read this document thoroughly and retain it for future reference.</p> <p>Non-respect of these instructions may reduce performances and safety of the devices and cause danger for people and property.</p> <p>The products must be installed, operated, serviced and maintained by qualified personnel in compliance with applicable standards and regulations.</p> <p>Don't open the device, it does not contain replaceable components, the tripping of the internal fuse (if included) is caused by an internal failure.</p> <p>Don't repair or modify the device, if malfunction or failure should occur during operation, send unit to the factory for inspection. No responsibility is assumed by Nextys SA for any consequences deriving from the use of this material.</p>	<p>Prima dell'installazione, leggere attentamente questo documento istruzioni e conservarle per future consultazioni. L'inosservanza delle presenti istruzioni può compromettere le caratteristiche e la sicurezza dell'apparecchio e causare pericolo per le persone e le cose.</p> <p>Il prodotto deve essere installato, utilizzato e riparato da personale qualificato e nel rispetto delle normative vigenti.</p> <p>Non aprire il prodotto, esso non contiene componenti sostituibili, il guasto del fusibile interno (se previsto) è causato da un guasto interno. Non tentare di riparare o modificare il prodotto, se durante il funzionamento si verificano guasti o anomalie, inviarlo al produttore per il controllo.</p> <p>Nextys SA non si assume nessuna responsabilità per qualunque conseguenza derivante dall'uso di questo materiale.</p>	<p>Lisez ces instructions avant l'installation, conservez ce manuel pour référence future.</p> <p>Défaut de se conformer à ces instructions peut affecter les caractéristiques et la sécurité du dispositif de danger et de causer aux personnes ou aux biens.</p> <p>Les produits doivent être installés, exploités et entretenus par personnel qualifié et en conformité avec les règlements.</p> <p>N'ouvrez pas le produit, il ne contient aucune pièce réparable, le déclenchement du fusible interne (le cas échéant) est causé par un défaut interne. Ne pas essayer de réparer ou modifier le produit ; si des défaillances se produisent pendant le fonctionnement ou les dysfonctionnements, le retourner au fabricant pour inspection. Nextys SA n'assume aucune responsabilité des conséquences éventuelles découlant de l'utilisation des produits.</p>
CAUTION	ATTENZIONE	AVVERTISSEMENT
<p><b>RISK OF BURNS, EXPLOSION, FIRE, ELECTRICAL SHOCK, PERSONAL INJURY.</b></p> <p>Never carry out work on live parts! Danger of fatal injury! The product's enclosure may be hot, allow time for cooling product before touching it. Do not allow liquids or foreign objects to enter into the products.</p> <p>To avoid sparks, do not connect or disconnect the device before having previously turned-off input power and wait for internal capacitors discharge (minimum 1 minute).</p> <p><b>Radio interference!</b> This is an electrical appliance according to EN55032, class A. It may cause radio interference in residential areas.</p>	<p><b>RISCHIO USTIONI, ESPLOSIONE, INCENDIO, SCOSSA, LESIONI GRAVI.</b></p> <p>Non effettuare mai operazioni sulle parti sotto tensione! Pericolo di lesioni letali! Il contenitore può scottare, lasciar quindi raffreddare il dispositivo prima di toccarlo. Non far entrare liquidi o oggetti estranei nel dispositivo.</p> <p>Per evitare scintille, non collegare o scollegare l'apparecchiatura prima di avere tolto tensione di ingresso e prima che sia avvenuta la scarica dei condensatori interni (min. 1 minuto).</p> <p><b>Interferenza radio!</b> Questo apparecchio è un dispositivo di classe A secondo lo standard EN55032. Può causare interferenze radio nelle aree residenziali.</p>	<p><b>RISQUE DE BRULURES, EXPLOSION, INCENDIE, ELECTROCUTION, DOMMAGE AUX PERSONNES.</b></p> <p>Ne jamais effectuer des opérations sur les parties sous tension! Danger de mort! Le récipient peut produire des brulures, le laisser refroidir avant de toucher l'appareil. Ne faites pas pénétrer des liquides ou des corps étrangers dans l'appareil. Pour éviter des étincelles, ne pas connecter ou déconnecter l'équipement jusqu'à ce que vous avez supprimé la tension d'entrée et avant qu'elle n'ait lieu de décharge des condensateurs internes (minimum 1 minute).</p> <p><b>Perturbations radioélectriques!</b> Cet appareil est un dispositif de catégorie A selon le standard EN55032. Il peut causer des perturbations radioélectriques dans les zones résidentielles.</p>

DECLARATION OF CONFORMITY				
		<p><b>NEXTYS SA.</b> Via Luserte Sud 6, 6572 Quartino - Switzerland Phone: +41-(0)91 840 14 46 / 840 14 48; Fax: +41-(0)91 840 14 47 E-mail: info@nextys.com</p>		
<p>This Declaration of Conformity is suitable to the European Standard EN45014 "General criteria for supplier's declaration of conformity". We declare under our sole responsibility that the device included in this box, has passed all processing inspections and the final test and it is in conformity with the product requirements, including all reference codes and supply specifications.</p>				
<p><b>ROHS compliance:</b> the product respects the EC requirements related to ROHS substances, according to "Restriction of Hazardous Substances" as per document 2011/65/UE <b>REACH compliance:</b> the product respects the EC requirements related to REACH SVHC directive (2015) <b>Note:</b> all the reported information comes from our suppliers, NEXTYS SA. has not run any test to evaluate if the specific elements are present.</p>				
<p>All indicated devices are designed according to the latest Reference standards, if not expressly indicated through the official documents or files, they have been tested through our internal pre-compliance testing. Consult directly on www.nextys.com the reference standards applied to each model.</p>				
<p><b>Code</b> NUPS12 NUPS24</p>	<p><b>Description</b> Battery Charger and DC UPS module IN 13 – 14.5Vdc / OUT 10 - 15Vdc 10A Battery Charger and DC UPS module IN 26 – 28.5Vdc / OUT 20 - 28 Vdc 10A</p>			
<p><b>Certifications and approvals</b></p>				
<p><b>Reference standards</b></p>	<p>2014/35/EU (2014) 2014/30/EU (2014) EN61010-1 EN61010-2-201 UL508 EN61000-6-2 - EN61000-4-2 - EN61000-4-3 - EN61000-4-4 - EN61000-4-5 - EN61000-4-11 EN61000-6-4 - EN55011</p>			
		<p>(Low Voltage Directive) (EMC directive) (Safety Standards) (Safety Standards) (Certified - IND. CONT. EQ. 4WX9 file no. E356563) (Generic immunity standard for industrial environments) (Electrostatic discharge immunity test) (Radiated, radio-frequency, electromagnetic field immunity test) (Electrical fast transient/burst immunity test) (Surge immunity test) (Voltage dips, short interruptions and voltage immunity test) (Generic emission standard for industrial environments) (CISPR11 - EMC)</p>		

**USER INSTRUCTIONS**

<p><b>1) Description:</b> DIN rail mountable primary switched-mode power supply with 90...264Vac (110...345Vdc) input, suitable for Single phase main line and DC line.</p> <p><b>Functions:</b></p> <ul style="list-style-type: none"> <li>• <b>Battery +:</b> connection to battery PLUS</li> <li>• <b>Battery -:</b> connection to battery MINUS</li> <li>• <b>PS OK connector:</b> connection to SPDT contact for operating status/failure remote alarm (P.S. OK signal)</li> <li>• <b>Load +/-:</b> connection to load PLUS /MINUS</li> <li>• <b>IN +/-:</b> connection to power supply output PLUS /MINUS</li> <li>• <b>Battery fuse:</b> protects the battery and its cables against dangerous over currents. 15A Mini car Blade Fuse factory supplied is the max. allowed value, it can be replaced with a lower value fuse for a better protection with small batteries.</li> <li>• <b>Note:</b> if the fuse blows and if the module is fed only by the battery and without any voltage connected to IN+, IN- terminals, all LEDs of the module are turned off.</li> <li>• <b>Charging circuitry:</b> regulates and controls battery charging current. 2A or 4A charging current can be selected (see Fig.7). It's recommended to use 2A with battery capacity up to 20Ah and (if a faster charging time is not required) and 4A current with battery capacity 20-45Ah max.</li> <li>• <b>PS OK:</b> green LED, when it lights indicates that power supply is OK and that it is feeding the load and keeping battery under charge too.</li> <li>• <b>PS OK off:</b> indicates either that the power supply is turned off for AC mains black-out, or is disconnected from the AC mains, or that its output is overloaded and thus output is turned off for a short circuit - overload, or that the power supply failed.</li> <li>• <b>LOAD OK:</b> yellow LED, when it lights on indicates that the load receive power, either from the P.S. (PS OK LED On) or from battery (PS OK LED Off).</li> <li>• <b>BATT. OK:</b> green LED, with the power supply turned off or disconnected indicates that the battery is connected and charged.</li> <li>• <b>Attention:</b> with the power supply connected and active BATT. OK is always turned on even if the battery is not connected.</li> <li>• <b>BATT. LOW:</b> red LED, indicates that the battery is charged, increasing current required by the load and/or increasing the battery discharge. BATT. LOW LED lights on together with BATT OK, and its light intensity can vary depending on current required by the load, or blink if loads are switched on / off, due to unavoidable battery voltage variations depending on applied load. When BATT. LOW LED is lit, it is recommended to safely shut down the load, in order to avoid unexpected power loss.</li> <li>• <b>Failure contact:</b> at 1A/24V SPDT contact switches when the battery starts back-up feed of the load. The remote signal informs that the system is no more fed by the DC power supply e.g. for a fuse failure or for a power supply failure, thus giving a warning even if there is not a general and visible black-out but only a local failure.</li> </ul> <p>NUPSxx restart after a long duration black out with low battery. In such condition the module has disconnected the battery from the load (to prevent total discharge and thus battery damage). It can be started up only by feeding IN+, IN - with a 24Vdc source (e.g. the power supply or a battery). By connecting only the discharged battery to BATT. +/- terminals the module cannot be restarted. If the module is feeding the load from the back-up battery and if a short circuit makes the battery protection fuse to blow, the module can be re-started (after fuse replacement) only by first connecting a 24Vdc power source to IN+,IN - terminals.</p>	
<p><b>2) Installation:</b> use DIN-rails according to EN60715. Installation should be made vertically (see Fig.4). For better device stability fix the rail to the wall close to the point where the device is to be mounted. In order to guarantee sufficient convection, we recommend observing a minimum distance to other modules (see Fig.3). The device is provided with a thermal protection; a limited air flow can cause the thermal protection tripping. The SMPS automatically restarts after cooling. To get normal operation reduce the temperature of the air surrounding the power supply, increase the ventilation or reduce the load (see Fig.8)</p> <p><b>Warning!</b> Follow the connection procedure carefully, not respecting this procedure could irreversibly damage the device (see Fig.1 as reference).</p> <ul style="list-style-type: none"> <li>• Connect BATT+ and BATT- of the supplied plug connector to the own battery/ies, respecting the polarity.</li> <li>• Plug the BATT+/- connector to the device, check that the red "REVERSE POLARITY" LED is OFF; if ON, check the wiring again by adjusting the polarity.</li> <li>• Connect IN+ and IN- of the supplied plug connector to own power source, respecting the polarity.</li> <li>• Connect LOAD+ and LOAD- of the supplied plug connector to own load, respecting the polarity.</li> <li>• Plug the IN+/-, LOAD+/- connector to the device.</li> <li>• Power-on the power source and verify that everything is working properly.</li> </ul>	
<p><b>3) Connections:</b> the device is equipped with pluggable screw terminals. To avoid sparks, do not connect or disconnect the connectors before having previously turned-off input power and waited for internal capacitors discharge (minimum 1 minute). In order to comply with UL certification, use appropriate copper cables of indicated cross section, designed for an operating temperatures of: 60°C for ambient up to 45°C 75°C for ambient up to 60°C 90°C for ambient up to 70°C Strip the connecting ends of the wires according to the indication and ensure that all strands of a stranded wire enter the terminal connection (see Fig.5)</p>	
<p><b>4) Battery protection:</b> protects the battery and its cables against dangerous over currents. 15A Mini car Blade Fuse factory supplied is the max. allowed value, it can be replaced with a lower value fuse for a better protection with small batteries (see Fig.6)</p>	
<p><b>5) DC input connection:</b> connect IN+ terminal to (+) positive pole and IN- terminal to (-) negative pole of the own power source. The device is also suitable for photovoltaic or wind turbine applications (see Fig.7).</p>	
<p><b>6) Output connection:</b> The device is suitable for SELV and PELV circuitry. Check Uout before connecting the NUPSxx to the load. With output voltage set to the max. value, the continuous current must not exceed the nominal current 10A max.</p>	
<p><b>7) Protection:</b> the device is protected against</p> <ul style="list-style-type: none"> <li>• <b>REVERSE battery connection:</b> a red LED indicates that battery is connected with reversed polarity.</li> <li>• <b>Protection diode:</b> it avoids the voltage and current supplied by the battery to circulate through the power supply output circuitry and prevents failures due to reverse polarity connection.</li> <li>• <b>Deep discharge battery protection circuit:</b> this circuit disconnects the battery when its voltage drops under DDV voltage, to avoid battery damage.</li> </ul>	

**8) GENERAL INFORMATION ON BATTERIES**

**Rated voltage:** is the voltage that the battery can supply in condition of full charge and rated current. Battery voltage without load is always higher of rated voltage.

**Capacity:** given in Ah (Ampere / hour) measured at 25°C/ 77°F. (e.g. at 10Ah battery can supply 10A for 1 hour or 1A for 10 hours).

**Charging current:** is the current to be applied to charge the battery, usually indicated by the manufacturer. A charging current higher than specified can damage the battery or shorten its life, a too low charging current results in a too long charging time and uncompleted or partial charge, thus reduced Ah capacity.

Charging current of sealed lead batteries would never exceed 20% of capacity of the battery. The battery limits by itself the charging current supplied by the battery charger, depending on its charge status. Only when the battery is completely discharged it's possible to apply the maximum charging current.

**Note:** when choosing the capacity of the battery, consider that real capacity indicated by manufacturers can vary compared with rated capacity depending quality and cost, capacity is always given for new battery at 25°C/77°F, but during battery life it's capacity decreases due to ageing, even if the battery is not used, so calculate battery capacity and duration considering the worst operating conditions.

**Discharge voltage:** the right charging voltage value is given by the manufacturer; generally the voltage/current source must be capable to supply a voltage 10-15% higher than rated voltage of the battery. If charging voltage is lower than +10% of battery rated voltage, charging time increases and produce an uncompleted charge and thus a reduced capacity. Charging voltages higher than +20% of rated voltage can damage the battery and shortens its life.

**Charging time:** varies according to charging current/voltage. Consider a minimum charging time of 3-4 hours after a battery discharge.

**Discharged battery:** a battery is considered discharged when its voltage, measured applying a 50% load, is lower than -10% of rated voltage, or when voltage measured with no load is lower than rated voltage.

**Total discharge:** when a battery gives a voltage between 0 - 60% of rated voltage, it's totally discharged. Total or deep discharge reduces battery life and must be avoided. Disconnect the battery from the load when voltage is lower than e.g. 18V/9V in at 24V/12V battery.

**Operating temperature:** for a long duration of the battery operating temperature must be kept within 10°C/+50°F...30°C/+ 86°F. Battery duration decreases outside this range. At low temperatures the battery might not supply rated Ah, because electrochemical reaction are less efficient.

**Overload-short circuit battery protection:** battery and its connecting cables must be protected with overcurrent protection devices (fuses, circuit breakers, etc.) able to cut-off dangerous currents.

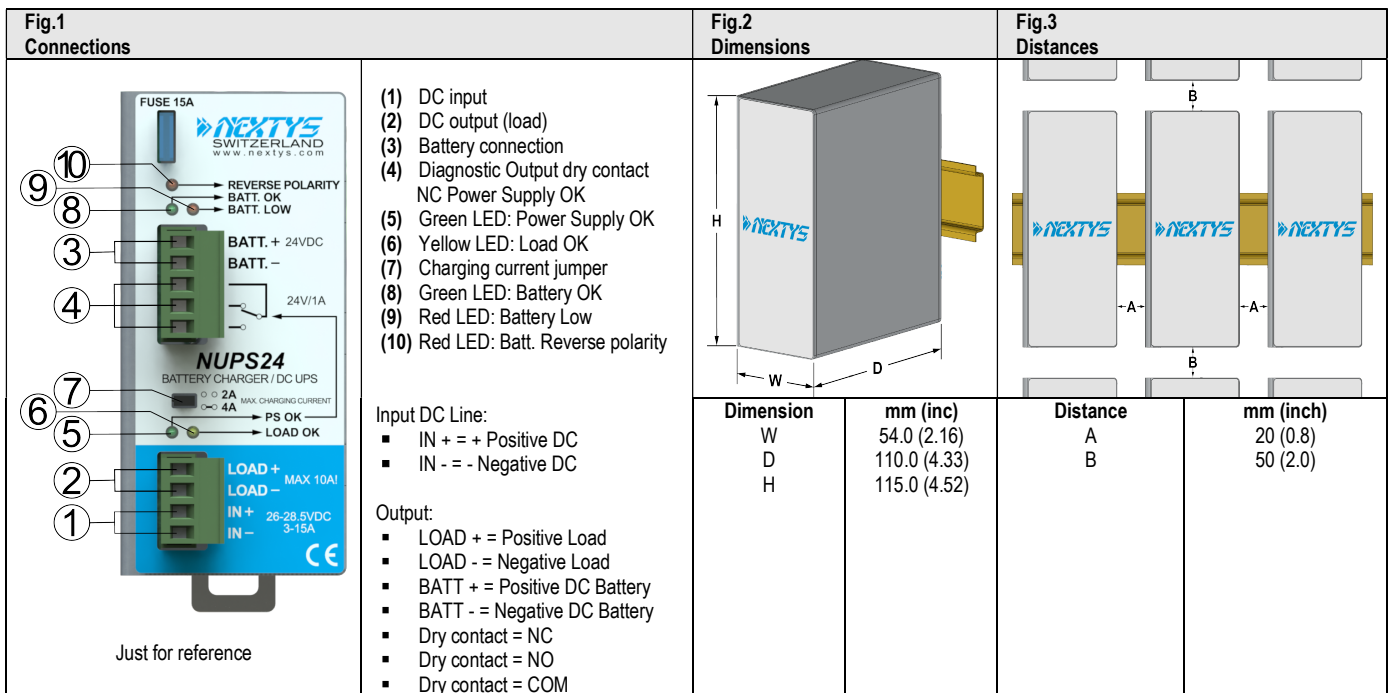

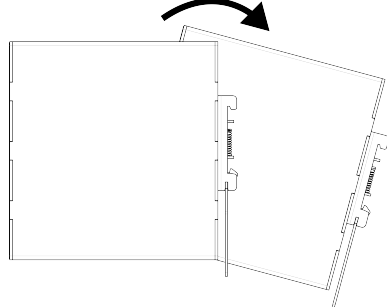
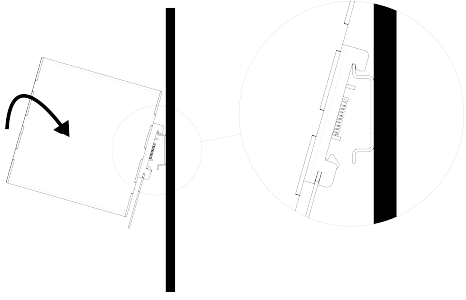
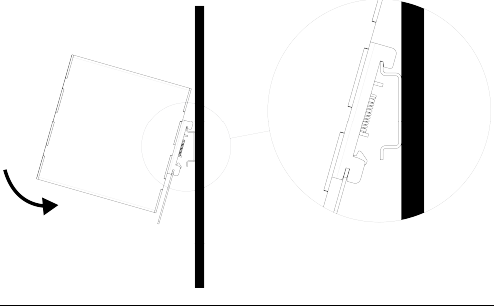
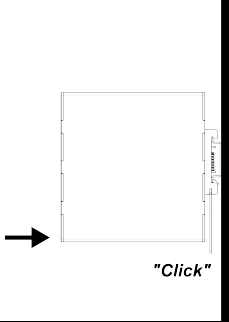
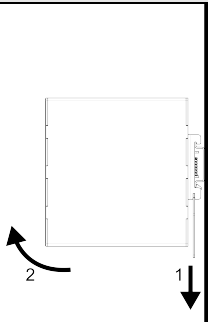
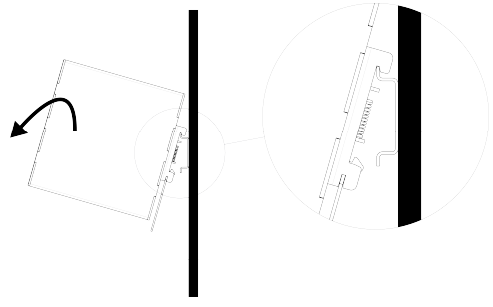
<b>Fig.4</b> <b>Mounting / Dismounting Instructions</b> For DIN rail fastening according to IEC 60715 TH35-7.5(-15) Mounting as shown in figure, with input terminals on lower side, with suitable cooling and maintaining a proper distance between adjacent devices as specified in the I.S. manual of each family.				
<b>Mounting:</b>				
1. Tilt the unit slightly backwards. 2. Fit the unit over the top edge of the rail. 3. Slide it downward until it hits the stop. 4. Press against the bottom for locking.				
	1	2		
				
	3	4		
<b>Dismounting:</b>				
1. Pull down the slide clamp lever 2. Tilt the unit upward 3. Unhook the unit from the rail				
	1 & 2	3		

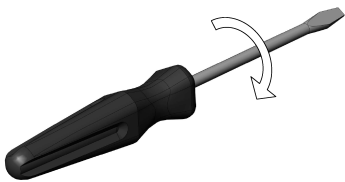
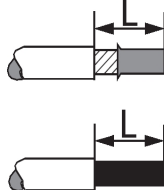
<b>Fig.5</b> <b>Recommended connecting cable</b>			
	<b>Recommended Tightening torque</b> 0.5-0.6 Nm 4.42-5.30 lbf in		Solid: 2.5mm <sup>2</sup> / 12AWG Stranded: 1.5mm <sup>2</sup> / 12AWG L: 6.0-7.5mm / 0.24-0.30 in

<b>Fig.6</b> <b>Input protection</b> Use Mini Car blade fuses 15A	
---	--

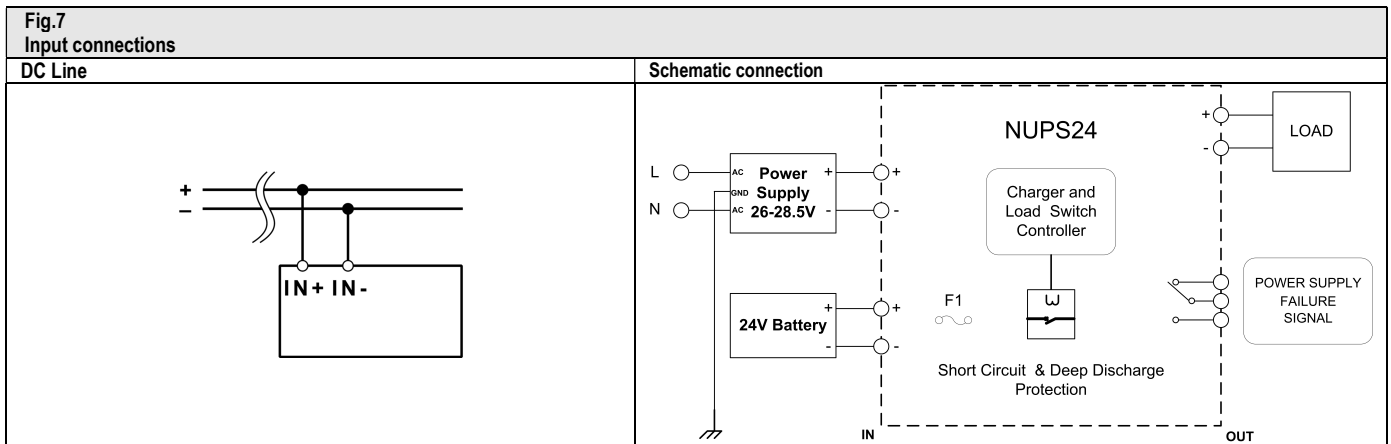

**Fig.8**  
**Environment**

Operating temperature	Derating
-40°C...70°C 5...95% r.H. non condensing UL Certified up to 60°C	- 0.25A/°C over 60°C

**Note:**

- Data may change without prior notice in order to improve the product.
- Please refer to the latest version of the "Instruction Manual" for each product by visiting [www.nextys.com](http://www.nextys.com)

**See also the products below that can be used in conjunction with NUPSxx units:** *(accessory device)*

▪ <b>OR20</b>	20A Active ORing controller
▪ <b>OR50</b>	50A Active ORing controller
▪ <b>BU150U</b>	150J Buffer Module
▪ <b>NBP30</b>	Sealed Lead acid Battery pack