

## KVF-TDH Series 120W

Whole Family: KVF-XXXXX-TDH 12V/ 24V /48VDC - [ 30W 60W 80W 96W 100W 120W 150W 200W 300W 320W 360W 500W 600W ]



### Features

Output:	Constant Voltage
Range:	200-240VAC
PFC design:	Built-in active PFC function
Efficiency:	Up to 85%
Protections:	Short circuit/ over load/ over temperature
Heat dissipation:	Cooling by free air convection
Waterproof performance:	IP66
Dimming function:	<u>Phase dimming</u> : work with leading edge and trailing edge, TRIAC dimmers.
Dimming range:	0-100%
Application:	Suitable for the application of LED lighting
Warranty:	5 years warranty
PWM Output Frequency	20KHz ( Flicker-free)

Phase cut /Triac dimmable driver-PWM output Dimmable LED driver 120W

Specification

Model		KVF-12120-TDH	KVF-24120-TDH	KVF-48120-TDH
Certificate		TUV / SAA(GMA certificate) / CCC / CE / CB / RoHS / Reach		
Output	DC Voltage	12V	24V	48V
	Voltage Tolerance	±0.5V		
	Voltage Regulation	≤0.5%		
	Rated current	10A	5A	2.5A
	Rated power	120W		
	Load Regulation	≤2%	≤1%	
Input	Voltage Range	200-240VAC		
	Frequency Range	47 - 63Hz		
	THD(Typ.) @ full load	≤20%@200VAC @230VAC @240VAC		
	Efficiency @ full load	83%@230VAC	84%@230VAC	85%@230VAC
	AC Current (Max.)	1.0A		
	Inrush Current (Typ.)	60.8A, 376us@230VAC		
	Leakage current	<0.5mA		
Protection	Short Circuit	Hiccup mode, re-power on to recover after fault condition removed		
	Over Load	≤120% Hiccup mode, recovers automatically after fault condition is removed		
	Over temperature	Shell surface temp.100°C±10°C shut down o/p voltage,automatically recover after the temperature drops.		
Environment	Working TEMP.	-40~+60°C (see below derating curve)		
	Working Humidity	20 - 95%RH non-condensing		
	Storage TEM.,Humidity	-40 - +80°C, 10 - 95% RH non-condensing		
	TEMP.coefficient	±0.03%/°C(0 - 50°C)		
	Vibration	10~500Hz, 5G 12min./1 cycle, period for 72min. each along X,Y,Z axes		
Safety & EMC	Safety standards	EN61347-1 EN61347-13(EU)		
	Withstand voltage	I/P-O/P:3.75KVAC I/P-FG:1.5KVAC O/P-FG:0.5KVAC (EU)		
	Isolation resistance	I/P-O/P:100MΩ / 500VDC / 25°C / 70%RH		
	EMC Emission	EN55015 EN61000-3-2,3 (EU)		
Others	Net Weight	1.05Kg		
	Dimension	230*70*43mm(L*W*H)		
	Packing	340*270*175mm 10pcs /CTN		
Notes	<p>1. All parameters NOT specially mentioned are measured at 230VAC input, rated load and 25°C of ambient temperature.</p> <p>2. Tolerance: includes set up tolerance and load regulation .</p>			

### Efficiency Curve (efficiency vs output load)

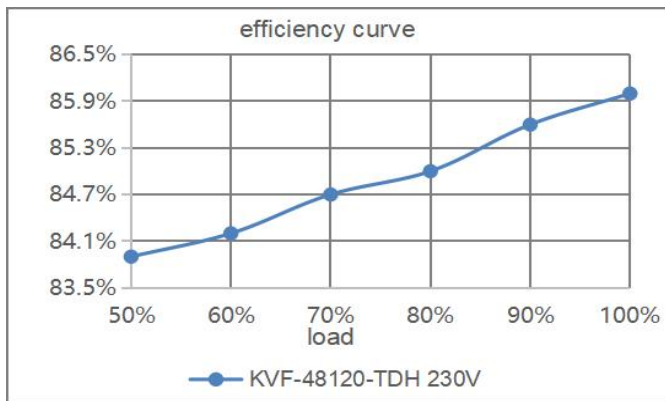
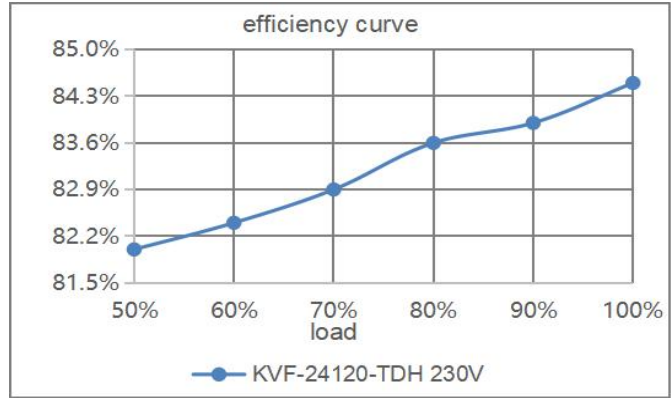
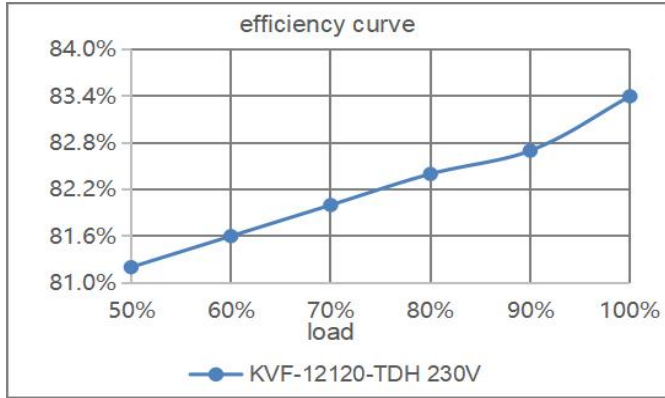

### Derating Curve (output load vs TEMP.)

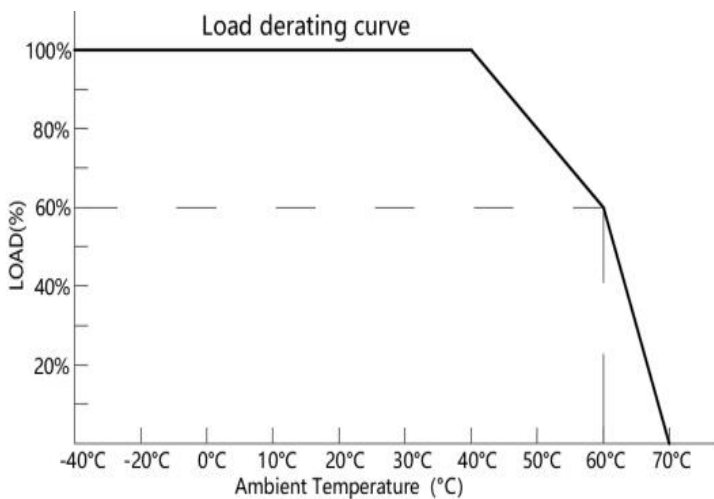

1. To extend their life, please refer to the Derating Curve and derate according to the temperature.
2. Please note that the rise in temperature of LED fixtures over a long period of time will cause their power to rise. Therefore, we recommend the power supply to reserve a certain amount of load to avoid overloading.

### Power Factor Curve

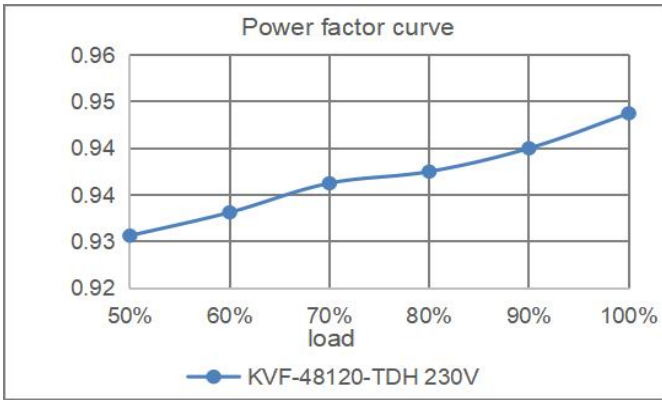
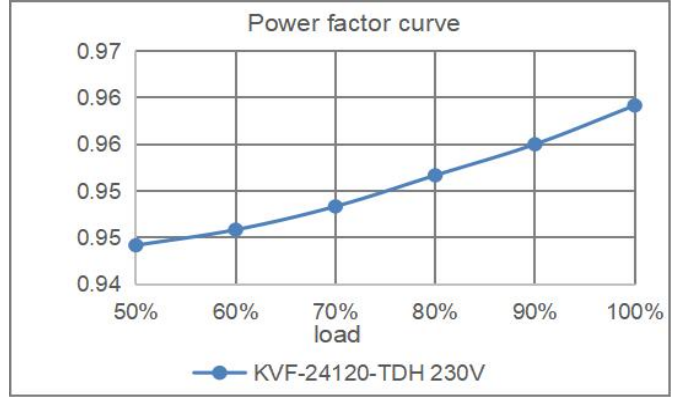
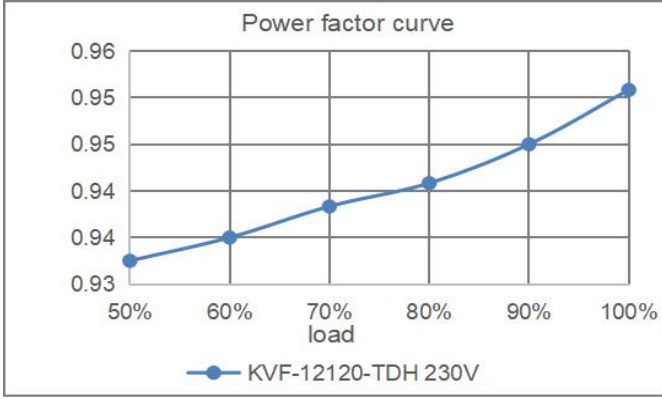

### Mechanical Specification

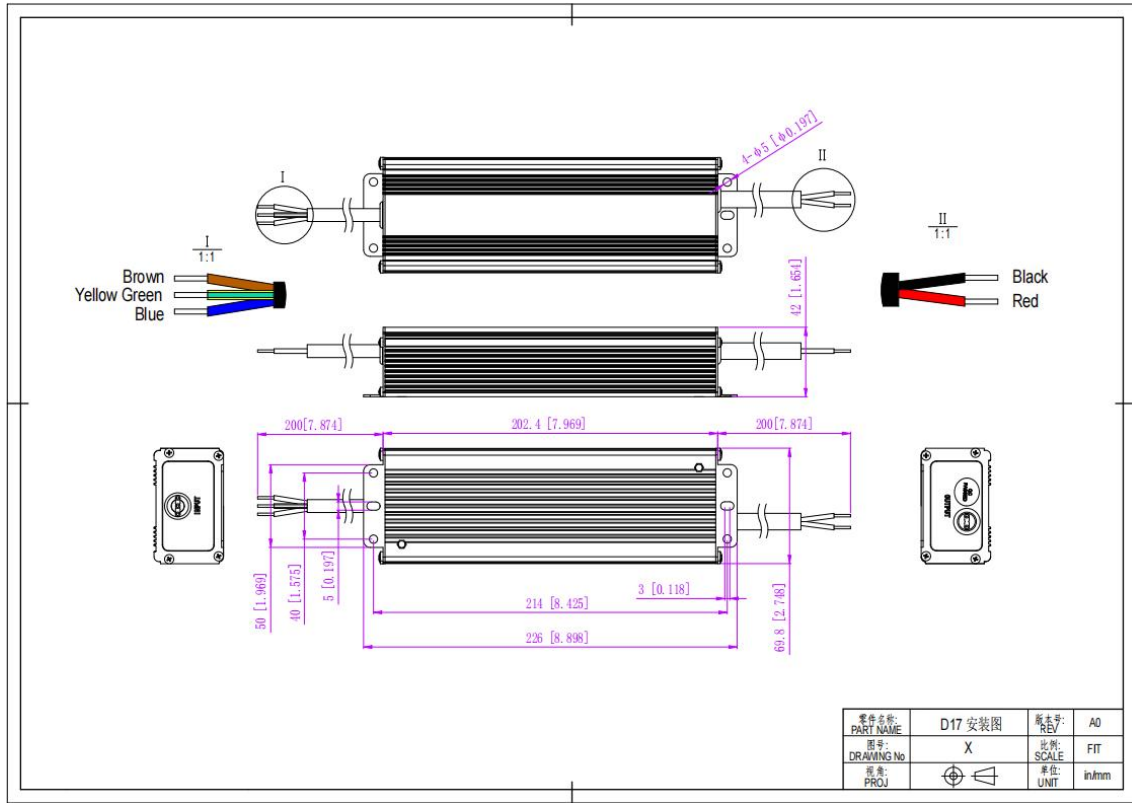

### 12V&24V&48V Version

1. Input cable 3C\*1.0mm<sup>2</sup>, the Green cable to (FG), Brown cable to L, and Blue cable to N of Mains AC.
2. Output cable 2C\*1.5mm<sup>2</sup>, Red cable (+) to LED Positive side (+), Black cable (-) to LED Negative side (-).
3. Please make sure you connect these correctly otherwise your product will not function correctly and could be damaged.

#### Warm tips:

1. Any other requests for, we can customized.

## Dimming Operation and Connecting Diagram

### TRIAC/Phase cut dimming

1. The Pulse-Width Modulation (PWM) of output voltage can be adjusted through input terminal of the AC phase line(L) by connection a phase /Triac dimmer or lighting system.
2. Working with leading edge and trailing edge, TRIAC dimmers.
3. Min. loading is about 10%.
4. Please try to use dimmers with power at least 1.5 times as the output power of the driver.

### Triac

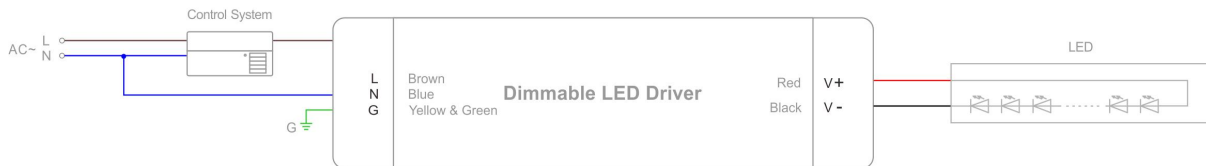

### Triac

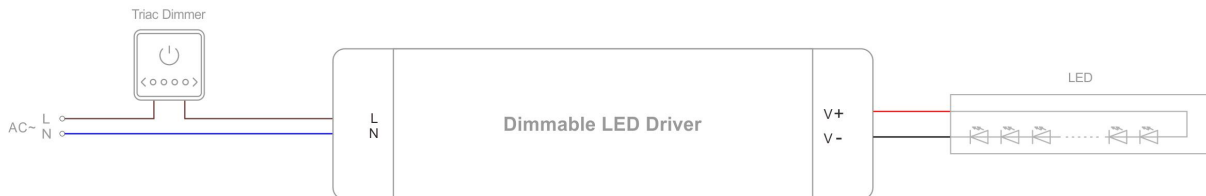

## Instruction

1. This driver should be installed by qualified and professional person.
2. Please make sure the driver is installed with adequate ventilation around it to allow for heat dissipation.
3. Ensure that wiring is correct before test in order to avoid light and power supply damage.
4. If driver Cannot work normally, don't maintain privately.

Have any questions, please contact Zuhai Shengchang.

Please visit our website or contact us for more information! [www.scpower.net.cn/en](http://www.scpower.net.cn/en)