

proconnecting

Made in Germany

PDR-480/HPV04801

480W Industrial Power Supply

TS35mm DIN-Rail mains supply with high output voltage



Specification:

- C/V curve down to 0V, no foldback
- Power Good Relay AC & DC-ok optional
- Efficiency up to 93%
- Hold up time >50ms
- Soft start & auto-recovery
- Precise dynamic response to load change
- Designed for long life under full stress
- Strong input filters
- High reliability, shock & vibration proof
- EMC meets CE norm class B
- Overload and short circuit protection
- Large terminals 4x AWG20 – AWG6 (0,5 – 16mm²)

Models	Voltage	Voltage setting
HPV04801.072	72Vdc	58 – 86Vdc
HPV04801.110	110Vdc	86 – 132Vdc
HPV04801.150	150Vdc	132 – 180Vdc
HPV04801.220	220Vdc	180 – 240Vdc



In accordance with IEC60950-1

ProConnecting GmbH – Brücknerstr. 5 – D-96146 Altendorf - Germany

Phone +49 (0)9545-44060-0 – Fax +49 (0)9545-44060-29 – www.proconnecting.de - info@proconnecting.de

(Subject to alterations. This product is not designed to be used in applications such as life support systems wherein a failure or malfunction could result in injury or death)

proconnecting

Made in Germany

Technical Concept

The Camtec HPV series is a high precision switch mode power supply for an upscale demand. It is engineered and manufactured by CAMTEC in Germany. The designed meets challenging applications like complex dc-drives, piezo print head, test-stands, and professional machine-building. The power supply provides a low ripple-noise, a precise load-regulation and high efficiency up to 93%. High-end long life capacitors guarantee an extended hold-up-time and an extraordinary lifetime of the power supply. The circuit design starts complex loads easily. The internal control circuit manages illegal operating conditions to prevent your system from damages. The HPV series features active high input transients with suppressor diodes, X2-capacitors and varistors. All inputs, outputs and feature connections are galvanic isolated. The design rules set value on extended interference immunity and safety. The unit is designed in accordance to the EN60950-1 and the EMC-compatibility to EN55022 class B norms. Our engineering design is made in accordance to the CSA/UL60950-1 and the IEEE CB scheme rules.

Features

Design Conception

The HPV power supply series realizes very high power efficiency in a space-saving housing. Latest generation electrical devices relate to the high reliability of all CAMTEC products. The CAMTEC philosophy is, to employ 125°C low ESR ultra long life capacitors where expedient to achieve a superior lifetime of the product. The HPV power supply is made for high reliable and demanding industrial applications, rail way, infrastructure, professional machine building, printing machines and complex dc-drive up to precision piezo drives.

DC-ok Power Good Relay (p.4)

The PG Relay connection indicates over temperature, low DC-voltage at the output and low AC supply voltage at the input.

Galvanic Isolation

The power supply is galvanic isolated between the input and the output. All features like the Power Good Relay are connected to the DC power outputs.

Thermal shutdown (p.5)

The HPV is featured with a thermal overload shut down and auto recovery behaviour.

Over Voltage Protection (p.5)

Ticker mode and auto recovery

Short Circuit Protection

A continuous short circuit does not cause damage to the power supply. The HPV delivers constant current and 0 output voltage. It recovers automatically after the short circuit is released.

Open Circuit Protection

The HPV series is continuously open circuit protected. The device delivers a stable output voltage and no current. If a load is immediately connected to the device, the power supply stabilizes within 1ms. It does not overshoot the output voltage.

Power Up Ramp

The devices has a soft start ramp when powering up. The device does not either overshoot the voltage nor does the output flutter – independent if a load is connected or not.

Current Voltage Chart, CV & CC mode (p.4)

The HPV series provides a perfect current voltage chart. It has no fold back or other abnormalities. The output voltage can drop down to zero volts when the power supply is overloaded. The unit delivers a stable and constant current to the outputs.

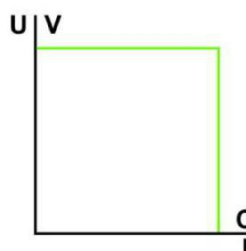

Technical Data Table				
AC Input Range	90 – 132Vac / 184 – 265Vac , 47 – 63Hz (115/230Vac input selector, factory setting is 230Vac)			
DC Input Range	250Vdc – 375Vdc (input selector set to 230Vac)			
AC Input Rating	115Vac<8.8A 230Vac<4.3A (recommended circuit breaker type B with 16A or larger)			
DC Input Rating	250Vdc<2.4A 375Vdc<1.6A (input selector set to 230Vac rated)			
Rated DC Voltage	72Vdc	110Vdc	150Vdc	220Vdc
Rated DC Current	6,7A	4,4A	3,2A	2,2A
DC Voltage Setting Range	58 – 86Vdc	86 – 132Vdc	132 – 180Vdc	180 – 240Vdc
Power Boost	7,4A	4,8A	3,5A	2,4A
Overvoltage Protection	100Vdc	154Vdc	210Vdc	310Vdc
Ripple Peak 230Vac 20MHz	150mV	200mV	300mV	400mV
OR Failure Relay (option)	Yes, break contact, protective forced isolation to the inputs and the output 3000Vac			
Derating	+60°C...+70°C 2.5%/°C			
Accuracy	< ± 1.5% interface			
Load Regulation	< ± 0.05% 0-100%			
Response to Load Change	<1ms 10-100%, 100-10%			
Base Load	None required (open circuit proof)			
Efficiency 230Vac	Up to 93% at 90% load			
Short Circuit Protection	Continuous			
Open Circuit Proof	Continuous			
Temperature Control	Yes, thermal shutdown with auto recovery (+70°C, metering distance 10mm)			
Hold Up Time	>50ms 230Vac			
Inrush Current	NTC <40A 25°C cold start			
Soft Start	100ms typical			
Cooling	Natural convection			
Ambient Operating Temp.	- 25°C...+70°C			
Ambient Storage Temp.	- 40°C...+85°C			
Environment	Humidity 95% non-condensing @ 25°C, climate class. 3k3, pollution rate II			
ROHS	2011/65/EG confirmed			
REACH	EG No. 1907/2006 confirmed			
EMI	EN55022 class B			
EMS	EN61000-6-2,3			
Safety	cUL60950 (classified in accord. to EN60950-1), EN60950-1, EN60204-1			
Safety class 1(A)	VDE0805, VDE0100			
Isolation paths	> 8mm creepage distance & clearance paths			
Input to Output Isolation	3000Vac			
Input to Case Isolation	2500Vac			
Output to Case	2100Vdc			
Meantime By Failure (MTBF)	400000h (IEC61709)			
Meantime To Failure (MTTF)	128124h (IEC61709)			
Dimensions (HxWxD)	130x200x114,5 mm			
ROHS conformity	ROHS directive 2011/65/EU			
REACH conformity	REACH directive 1907/2006			
Weight	3000g			
AC Terminals	Input Screw Terminal 3x AWG20 – AWG6 / 0,5 – 16mm ² (L,N,PE)			
DC Terminals	Output Screw Terminal 4x AWG20 – AWG6 / 0,5 – 16mm ² (+ + / - -)			

Manual and Technical Details

Technical Data Table - Analogue Interface & Voltage Setting

Feature	Technology	Details and Connections	Section	Isolation
Potentiometer Voltage	1 turns	High precision	U adj	3000Vac to input & output
Power Good Relay	"b" contact	AWG22 – AWG6 / 0,25 – 2,5mm ²	DC-ok	3000Vac to input & output

The potentiometer and the optional power good relay provide a forced isolation. It is to ensure a protective isolation for the 264Vdc

DC Voltage setting range

Rated DC Voltage	72Vdc	110Vdc	150Vdc	220Vdc
Rated DC Current	6,7A	4,4A	3,2A	2,2A
DC Voltage Setting Range	58 – 86Vdc	86 – 132Vdc	132 – 180Vdc	180 – 240Vdc

The DC voltage can be adjusted with a precision 1 turn potentiometer with low temperature fading. The factory setting is to the rated voltage from the table above. We guarantee the above given adjustment ranges with a tolerance of -5/0% for the lower margin and 0/+5% for the upper margin.

DC-OK (Power Good Relay)

The DC ok relay indicates if the output voltage is low and if the AC voltage is low. The contact is galvanic insulated to the AC input and the DC output connections. The isolation is 3000Vac with a forced isolation and covers the overall adjustment range of the HPV model with 220Vdc. If the DC voltage is ok the relay is closed, if the power supply unit is in false operation the relay is open. Considering the lower and the upper margin of the AC voltage detection it is to say that the HPV series starts at 80Vac/150Vac depending on the AC input selector. The unit starts with 175Vdc when a DC voltage applies to the input. Make sure to set the AC input selector to 230Vac (factory setting) for DC input supply. DC-Fail hysteresis: drop-out 20% V_{nominal} / pull-in 60% V_{nominal}.

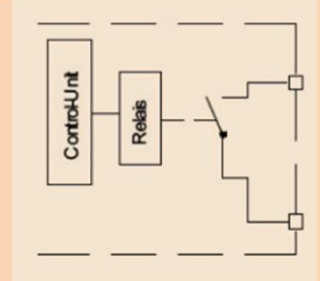

DC OK Indication

Power Supply Status	Normal	Over Temperature	AC Low [V]	DC Low [V]
Relay Operation status	Closed	Open	Open	Open

C/V Current Voltage Behavior

The HPV series provides a perfect current voltage chart. It has no fold back or other abnormalities. The output voltage can drop down to zero volts when the power supply is overloaded. The unit delivers a stable and constant current to the outputs.

When the output voltage is set to the maximum demanded value and the current limit circuit acts, the output voltage drops linear down to zero and the unit delivers constant current.

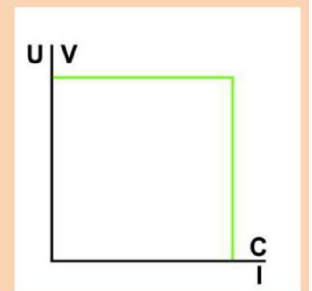

proconnecting

Made in Germany

Overtemperature Thermal Shutdown, Over Voltage Protection & Derating

OT Over Temperature The maximum ambient temperature is +70°C. If the power supply exceeds this value (over temperature protection) it completely shuts down (metering point 10mm from outside device). The device restarts automatically into operation when the temperature drops to a normal value.

OVP Over Voltage Protection Exceeding the OVP results in a locked shutdown mode. Resuming the failure causes automatic restart into normal operation. For the values please read the Technical Table on page 3.

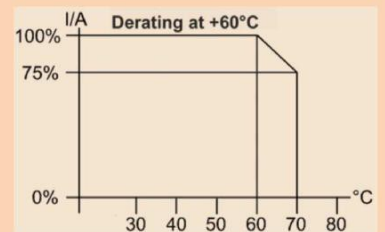

Baseplate Cooling & Temperature Management

The temperature management of the HPV series provides a direct dissipation of the main energy losses. The internal coolers of the output diodes and the power FETs connect to the back plate cooler. It is possible to dissipate about 40 – 50% of the energy losses out of a system to a plane and heat conductive surface. For further information please consult our technical support.

Parallel Operation & Decoupling

To increase the output power N+1 of the CPS-EC units can be parallel connected. Advise using busbars to connect several devices in parallel. Always use identical cabling length and identical cross sections to the busbar or a star point. The output voltage of each involved power supply units must be adjusted 100% equal. Set the small indicated switcher at the bottom of the power supply from "single" (factory preset) to "parallel" operation. The C/V characteristic line will slightly rearm. The control circuit switches the amplifier FETs softer. The power-output distribution between the involved units will be more accurate.

The HPV models have no internal O-ring diode. For decoupling N+1 devices. Up to 125Vdc we recommend to use our RED00202 DIN rail diode module. It is capable to decouple 2pcs of the HPV power supplies from each other. To increase the power capability RED models can be connected in parallel. For higher voltages an external decoupling diode shall be installed from the system engineer.

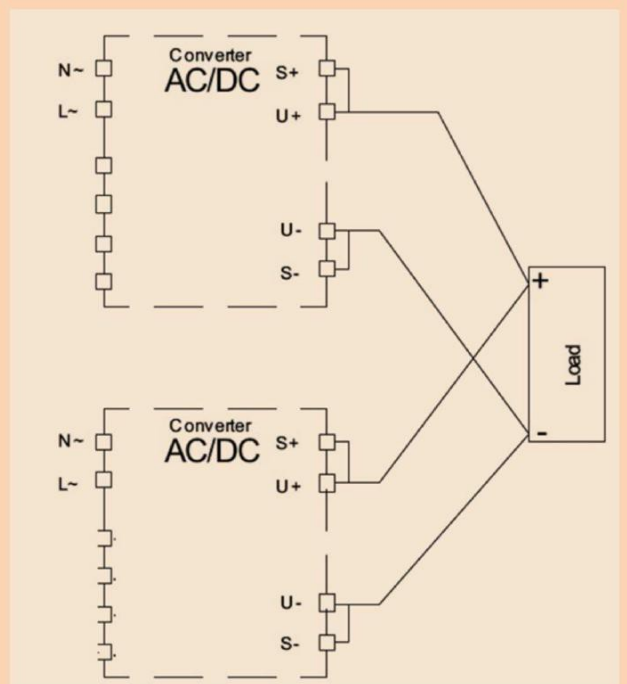

Coating Option

We offer the HPV series with an optional coating. It is to be used in e.g. dusty, dirty, high humidity area or in awaiting quick temperature changes. Short circuit and corrosion at print board lines and at solder points can be prevented. The coat itself is a transparent acrylic resin.

Peters SL 1306 N-FLZ (transparent) IEC60216-1 2001, IPC-CC-830B, UL listed as permanent coating FileNo.: E80315, UL94V-0

Ordering Information: add extension **C** to the model name (example): HPV04801.110TPG**C**

proconnecting

Made in Germany

Safety Test

	T	A	B	C	D	
Type Test	60s	2500Vac	3000Vac	2100Vdc	3000Vac	Type test and factory tests are conducted by the manufacturer. Do not repeat the test in field. Field test rules:
Factory Test	5s	2000Vac	2000Vac	2100Vdc	2000Vac	
Field Test	2s	2000Vac	2000Vac	2100Vdc	2000Vac	

- Use appropriate test equipment which apply the voltage with a slow ramp
- Connect L1 and N together, as well as all output poles
- Use only AC test-voltages with 50/60Hz. The output voltage is floating and has no ohmic reference to ground.
- If testing output voltages are $\geq 60Vdc$ remain to security directives. Use only isolated screw drivers to adjust output voltages.

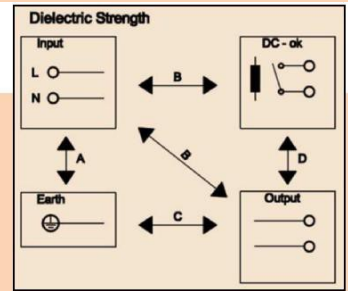

Connections

AC (DC) Mains Input

GND common
N - wire
L - wire

DC Mains

DC + voltage
DC + voltage
DC - voltage
DC - voltage

Interface

DC-ok. = Power Good Relay

Mechanics

Stable metal/aluminium housing IP20. To allow adequate convection, a free air space of 50mm (top/bottom) and 5mm (sidewalls) is required; for active devices 15mm space from the sidewalls. For free air convection it is necessary to install the unit horizontal. Use the DIN-Rail installation (equiped standard) with the patented 35mm DIN-Rail brackets according to EN60275. It is easy to mount/dismount while snapping it onto the 35mm DIN-Rail - no tools are necessary.

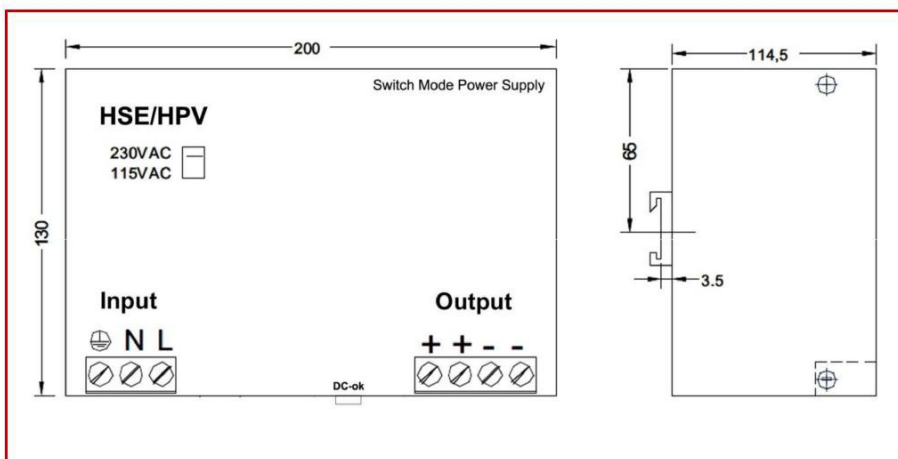
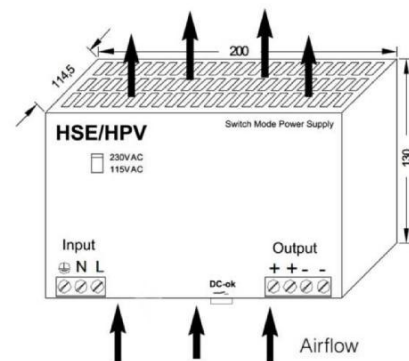
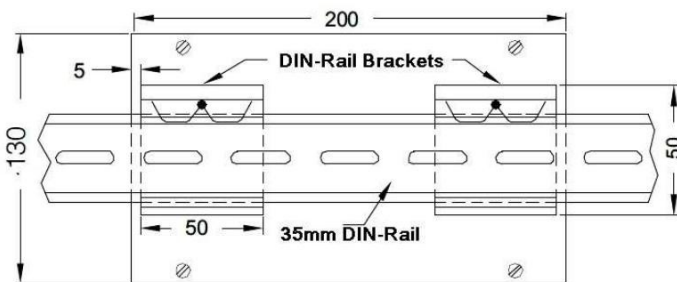

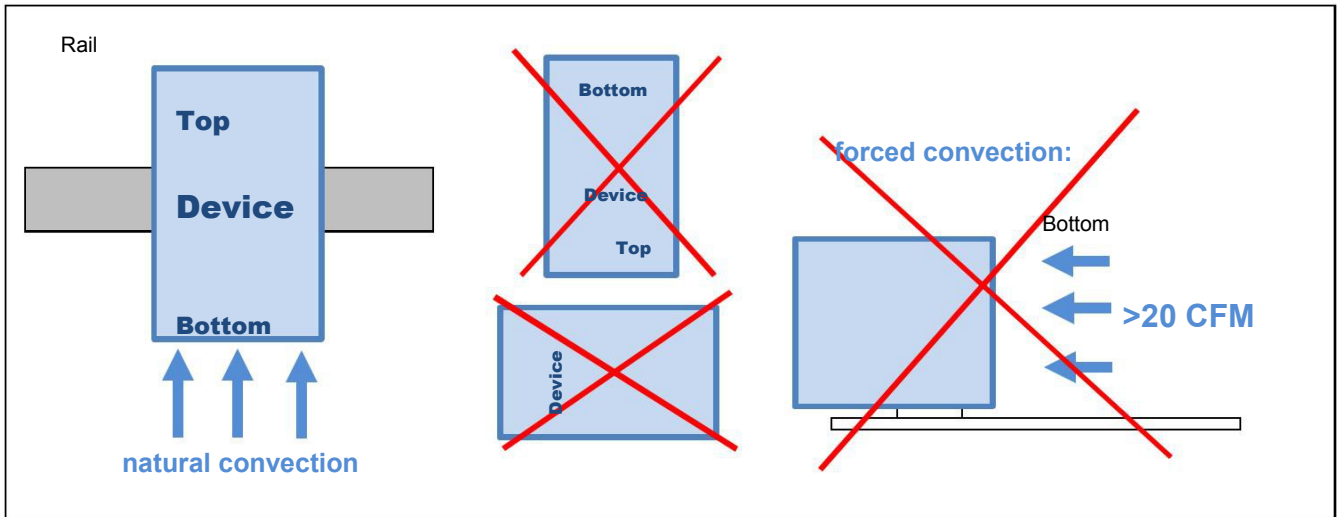

Mounting Instruction: recommended airflow space below and above is 50mm (2 Inch)

Stock Numbers

Model (DIN-Rail standard)	Voltage	PG Relay	Part Number	Purchase Order Number
HPV04801.072T	72V	No	304.1068.001	304.1068.001CA
HPV04801.110T	110V	No	304.1068.002	304.1068.002CA
HPV04801.150T	150V	No	304.1068.003	304.1068.003CA
HPV04801.220T	220V	No	304.1068.004	304.1068.004CA
HPV04801.072TPG	72V	Yes	304.1068.011	304.1068.011CA
HPV04801.110TPG	110V	Yes	304.1068.012	304.1068.012CA
HPV04801.150TPG	150V	Yes	304.1068.013	304.1068.013CA
HPV04801.220TPG	220V	Yes	304.1068.014	304.1068.014CA

Safety Instructions: Please read all warnings and advices carefully before installing or operating this switch mode power supply unit. Retain this operation manual always ready to hand. The power supply must be installed by specialist staff only.

Installation:

- 1.) The unit is designed for systems fulfilling the safety norms of dangerous voltages/energy and fire prevention
- 2.) Installation is restricted to specialists only, make sure that the AC wire system is free of voltage
- 3.) Opening the device, making any modifications to it, dismantling any screws from it, operating the item out of specification and/or using it in appropriate area will inevitably result in loosing manufactureres guarantee; we decline taking any responsibility for risk of damages caused to someones health or to any installed system.
- 4.) Attention: The power supply has an internal input fuse. It is necessary to wire an automatic circuit braker to the line. We suggest to use a 16A-type with B-characteristic. It is prohibited to operate the device without protective earth wired. We propose to install a line switcher in front of the power supply.

Warnings:

Disregard these warnings can cause fire, electic shock, serious accident and death.

1. Never operate the device without Protective Earth Conductor.
2. Before connecting the item to the AC wire system make all wires free of voltage and assure accidently switch on.
3. Allow neat and professional cabeling.
4. Never open nor try to repair the power supply by yourself. Inside are dangerous voltages that can cause electric shock hazard.
5. Avoid metal pieces or other conductive material to fall into the item.
6. Do not operate the device under damp or wet conditions
7. Do not operate the unit under Ex conditions or in Ex-area

