



### ■ Features

- Constant Current mode output with multiple levels selectable by dip switch
- KNX/EIB protocol
- Flicker free design
- Support emergency lighting(EL)
- Integrated constant light output
- Integrated KNX push button interface
- Synchronization up to 10units
- Functions: Manual dim, operation hours, power consumption feedback, log/linear curve selection...etc
- 3 years warranty

### ■ Applications

- LED indoor lighting
- LED office lighting
- LED architectural lighting
- LED panel lighting

### ■ Description

LCM-25KN series is a 25W AC/DC constant current mode output LED driver featuring the multiple levels selectable by dip switch and the KNX interface to avoid using the complicated KNX-DALI gateway. LCM-25KN operates from 180~277VAC and offers different current levels ranging between 350mA and 1050mA. Thanks to the efficiency up to 85%, with the fanless design, the entire series is able to operate for -30°C~+85°C case temperature under free air convection. In addition, LCM-25KN is equipped with push dimming and synchronization so as to provide the optimal design flexibility for LED lighting system.

### ■ Model Encoding

**LCM - 25KN**

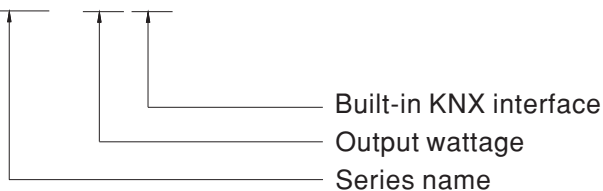



**SPECIFICATION**

<b>MODEL</b>		<b>LCM-25KN</b>					
<b>OUTPUT</b>	<b>CURRENT LEVEL</b>	Current level selectable via DIP switch, please refer to "DIP SWITCH TABLE" section					
		350mA	500mA	600mA	700mA(default)	900mA	1050mA
	<b>RATED POWER</b>	18.9W	25.2W				
	<b>DC VOLTAGE RANGE</b>	6 ~ 54V	6 ~ 50V	6 ~ 42V	6 ~ 36V	6 ~ 28V	6 ~ 24V
	<b>OPEN CIRCUIT VOLTAGE (max.)</b>	59V			41V		
	<b>CURRENT RIPPLE</b>	5.0% max. @rated current					
	<b>CURRENT TOLERANCE</b>	±5%					
	<b>SETUP TIME</b> Note.3	500ms / 230VAC					
<b>INPUT</b>	<b>VOLTAGE RANGE</b> Note.2	180 ~ 277VAC 220 ~ 392VDC (Please refer to "STATIC CHARACTERISTIC" section)					
	<b>FREQUENCY RANGE</b>	47 ~ 63Hz					
	<b>POWER FACTOR (Typ.)</b>	PF ≥ 0.94/230VAC, PF ≥ 0.91/277VAC@full load (Please refer to "POWER FACTOR (PF) CHARACTERISTIC" section)					
	<b>TOTAL HARMONIC DISTORTION</b>	THD < 20% (@load ≥ 50%/230VAC; @load ≥ 75%/277VAC) (Please refer to "TOTAL HARMONIC DISTORTION(THD)" section)					
	<b>EFFICIENCY (Typ.)</b> Note.4	85%					
	<b>AC CURRENT (Typ.)</b>	0.17A/230VAC 0.15A/277VAC					
	<b>INRUSH CURRENT (Typ.)</b>	COLD START 20A(twidth=260µs measured at 50% Ipeak) at 230VAC; Per NEMA 410					
	<b>MAX. No. of PSUs on 16A CIRCUIT BREAKER</b>	26 units (circuit breaker of type B) / 44 units (circuit breaker of type C) at 230VAC					
<b>LEAKAGE CURRENT</b>	<0.5mA / 240VAC						
<b>STANDBY POWER CONSUMPTION</b> Note.5	<0.5W						
<b>PROTECTION</b>	<b>SHORT CIRCUIT</b>	Constant current limiting, recovers automatically after fault condition is removed					
	<b>OVER TEMPERATURE</b>	Shut down o/p voltage, recovers automatically after temperature goes down					
<b>FUNCTION</b>	<b>DIMMING</b>	Please refer to "DIMMING OPERATION" section					
	<b>SYNCHRONIZATION</b>	Please refer to "SYNCHRONIZATION OPERATION" section					
<b>ENVIRONMENT</b>	<b>WORKING TEMP.</b>	Tcase=-30 ~ +85°C (Please refer to "OUTPUT LOAD vs TEMPERATURE" section)					
	<b>MAX. CASE TEMP.</b>	Tcase=+85°C					
	<b>WORKING HUMIDITY</b>	20 ~ 90% RH non-condensing					
	<b>STORAGE TEMP., HUMIDITY</b>	-40 ~ +80°C, 10 ~ 95% RH					
	<b>TEMP. COEFFICIENT</b>	±0.03%/°C (0 ~ 50°C)					
	<b>VIBRATION</b>	10 ~ 500Hz, 2G 10min./1cycle, period for 60min. each along X, Y, Z axes					
<b>SAFETY &amp; EMC</b>	<b>SAFETY STANDARDS</b>	CSA C22.2 No.250.13-12, IEC 60335-1, EN61347-1, EN61347-2-13, EN62384 independent, GB19510.14, GB19510.1, EAC TP TC 004 approved					
	<b>KNX STANDARDS</b>	certification					
	<b>WITHSTAND VOLTAGE</b>	I/P-O/P:3.75KVAC ; O/P-KN ±:500VDC					
	<b>ISOLATION RESISTANCE</b>	I/P-O/P:>100M Ohms / 500VDC / 25°C / 70% RH					
	<b>EMC EMISSION</b> Note.6	Compliance to EN55015, EN61000-3-2 Class C (@load ≥ 50%) ; EN61000-3-3; GB17625.1, GB17743, EAC TP TC 020					
	<b>EMC IMMUNITY</b>	Compliance to EN61000-4-2,3,4,5,6,8,11, EN61547, light industry level(surge immunity Line-Line 2KV), EAC TP TC 020					
<b>OTHERS</b>	<b>MTBF</b>	213.3K hrs min. MIL-HDBK-217F (25°C)					
	<b>DIMENSION</b>	105*68*23mm (L*W*H)					
	<b>PACKING</b>	0.173Kg ; 72pcs/13.5Kg/1.04CUFT					
<b>NOTE</b>	<ol style="list-style-type: none"> <li>All parameters NOT specially mentioned are measured at 230VAC input, rated current and 25°C of ambient temperature.</li> <li>De-rating may be needed under low input voltages. Please refer to "STATIC CHARACTERISTIC" sections for details.</li> <li>Length of set up time is measured at first cold start. Turning ON/OFF the driver may lead to increase of the set up time.</li> <li>Efficiency is measured at 500mA/50V output set by DIP switch.</li> <li>Standby power consumption is measured at 230VAC.</li> <li>The driver is considered as a component that will be operated in combination with final equipment. Since EMC performance will be affected by the complete installation, the final equipment manufacturers must re-qualify EMC Directive on the complete installation again.</li> <li>The ambient temperature derating of 3.5°C/1000m with fanless models and of 5°C/1000m with fan models for operating altitude higher than 2000m(6500ft).</li> </ol> <p>※ Product Liability Disclaimer : For detailed information, please refer to <a href="https://www.meanwell.com/serviceDisclaimer.aspx">https://www.meanwell.com/serviceDisclaimer.aspx</a></p>						

**BLOCK DIAGRAM**

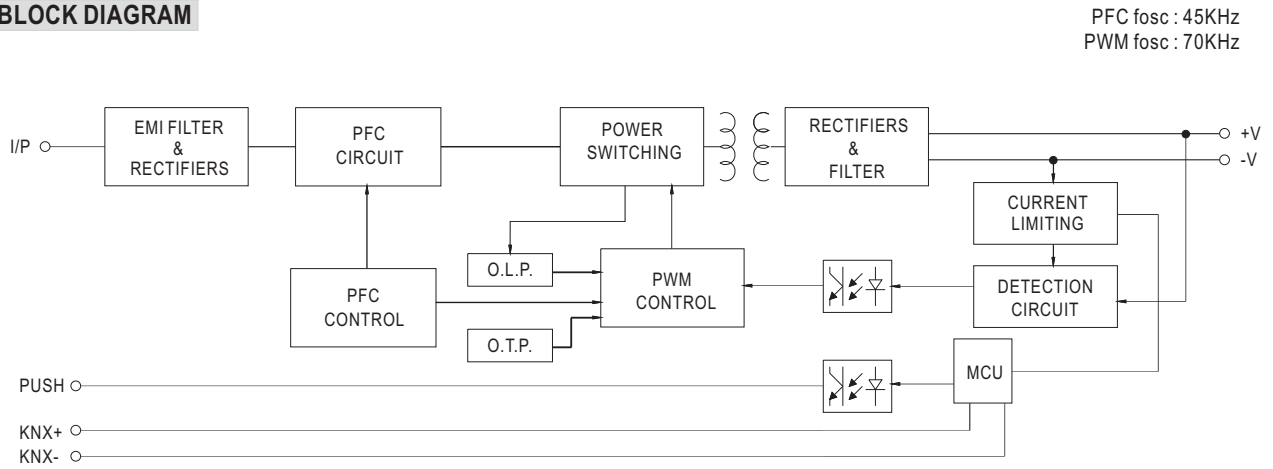

**DIP SWITCH TABLE**

LCM-25KN is a multiple-stage constant current driver, selection of output current through DIP switch is exhibited below.

Io	DIP S.W.	1	2	3	4	5	6	Max.LED voltage
350mA		----	----	----	----	----	----	54V
500mA		ON	----	----	----	----	----	50V
600mA		ON	ON	----	----	----	----	42V
700mA(factory default)		ON	ON	ON	----	----	ON	36V
900mA		ON	ON	ON	ON	----	ON	28V
1050mA		ON	ON	ON	ON	ON	ON	24V

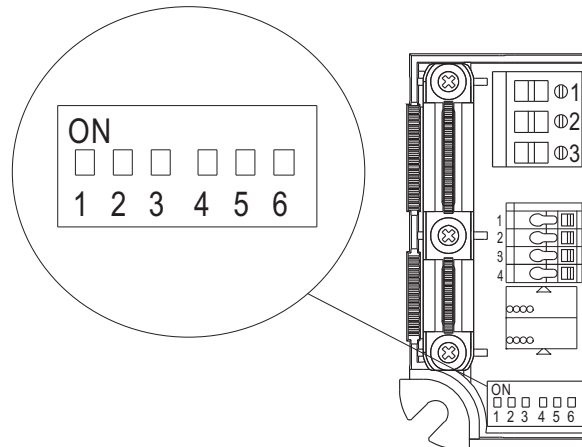

More current options through DIP switch are listed below.

Io	DIP S.W.	1	2	3	4	5	6	Max.LED voltage
450mA		----	ON	----	----	----	----	54V
550mA		----	----	----	ON	----	----	46V
800mA		ON	ON	----	ON	----	----	31V

Note: The Max. LED voltage connected at the output should be always less than the table above.

**■ DIMMING OPERATION**

✧ **KNX interface**

- Apply KNX Bus cable between KNX+ and KNX-
- The application program(database) can be downloaded via Online Catalogs from ETS or via <http://www.meanwell.com/productCatalog.aspx>

Parametrization options	Description
Switch functions	<ul style="list-style-type: none"> <li>• Turn on brightness</li> <li>• Dimming speed for turn on/off</li> <li>• Switch telegram and status</li> <li>• Switch on/off delay</li> </ul>
Dimming	<ul style="list-style-type: none"> <li>• Dimming speed for 0~100%</li> <li>• Allow switch on via relative dimming</li> <li>• Push dimming with AC inut port</li> <li>• Block object for push dimming</li> </ul>
Brightness value	<ul style="list-style-type: none"> <li>• Dimming speed for transition brightness values</li> <li>• Permit set switch on and off brightness via value</li> <li>• Brightness value and status</li> </ul>
Fault message	<ul style="list-style-type: none"> <li>• Lamp fault</li> <li>• AC/DC input monitor fault messages</li> </ul>
Other functions	<ul style="list-style-type: none"> <li>• Reaction on KNX voltage failure/recovery</li> <li>• Power-On level</li> <li>• Dimming curve select(linear/log)</li> <li>• Synchronous dimming output</li> <li>• Block function(Block1&amp;Block2)</li> <li>• Staircase lighting function(multi-stage switch-off)</li> </ul>
General function	<ul style="list-style-type: none"> <li>• Cyclic monitoring telegram(In operation)</li> </ul>
8 Scenes	<ul style="list-style-type: none"> <li>• Recall and save via KNX with 8-bit telegram</li> </ul>
Operating hours & CLO	<ul style="list-style-type: none"> <li>• Operating hours counter</li> <li>• Constant light out(5 scheduled divisions)</li> </ul>
Power consumption feedback	<ul style="list-style-type: none"> <li>• Power consumption report</li> </ul>

✧ **PUSH dimming or AC/DC input monitor(Primary side)**

◎ **PUSH dimming**

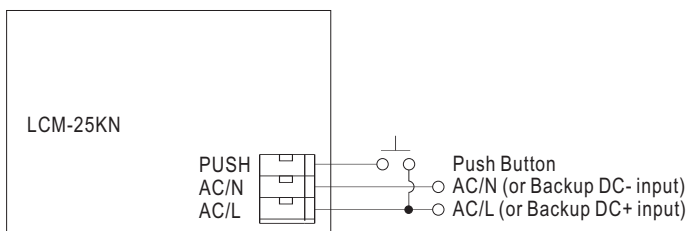

- The detail function of PUSH dimming, please refer to the database.
- Up to 10 drivers can perform the PUSH dimming at the same time when utilizing one common push button.
- The maximum length of the cable from the push button to the last driver is 20 meters.
- The additive push button can be connected only between the PUSH terminal, as displayed in the diagram, and AC/L (in brown or black); it will lead to short circuit if it is connected to AC/N.
- In case the PUSH dimming is set locally, up to 10 drivers can perform the PUSH dimming at the same time when utilizing one common push button.
- In case the PUSH dimming is set independently via ETS, the number of drivers is done through group address and determined by the ETS project designer.

◎ **AC/DC input monitor**

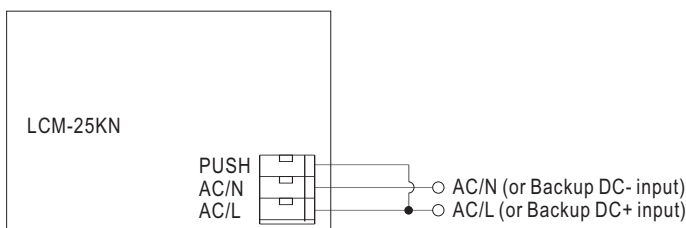

- KNX Bus need to connected when using AC/DC input monitor
- The detail function of AC/DC input monitor, please refer to the database.

■ **SYNCHRONIZATION OPERATION**

- Synchronization up to 10 drivers (1 master + 9 slaves)
- Dimming operating range : 10%~100%
- Sync cable length : < 5m
- Sync cable type : Flat cable
- Sync cable cross section area : 22 – 24 AWG (0.2~0.3mm<sup>2</sup>)

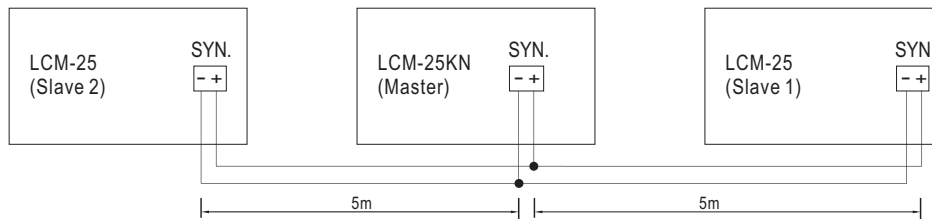

- NOTE: 1. Please make sure all units are set to 100% dimming setting (factory default) before synchronizing.  
 2. Min. Dimming operating range depends on database setting.

■ **OUTPUT LOAD vs TEMPERATURE**

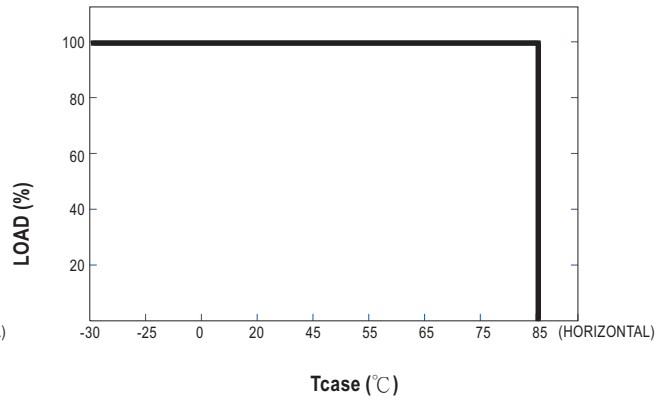
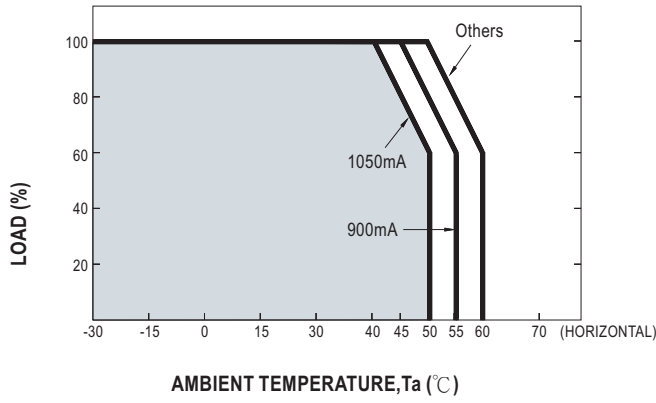

■ **STATIC CHARACTERISTIC**

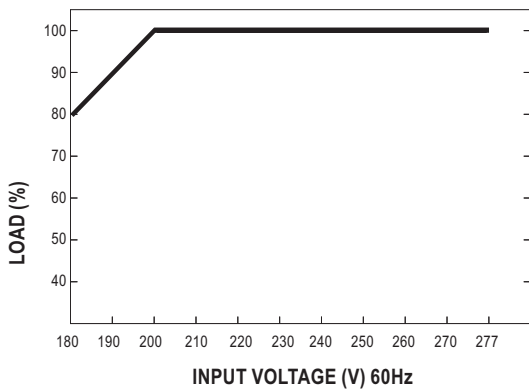

※ De-rating is needed under low input voltage.

**TOTAL HARMONIC DISTORTION (THD)**

※ Tcase at 75°C

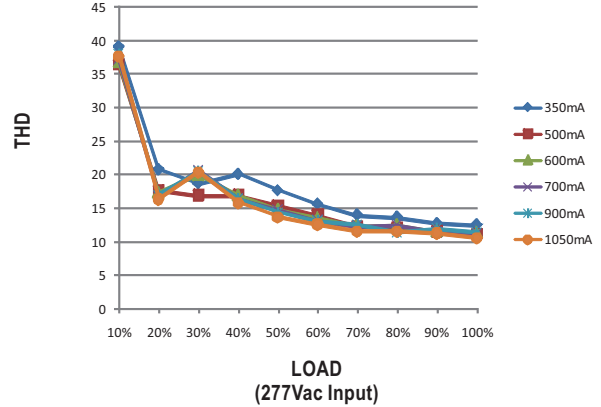
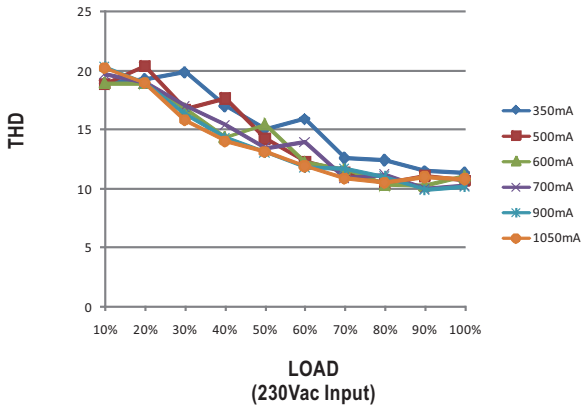

**POWER FACTOR (PF) CHARACTERISTIC**

※ Tcase at 75°C

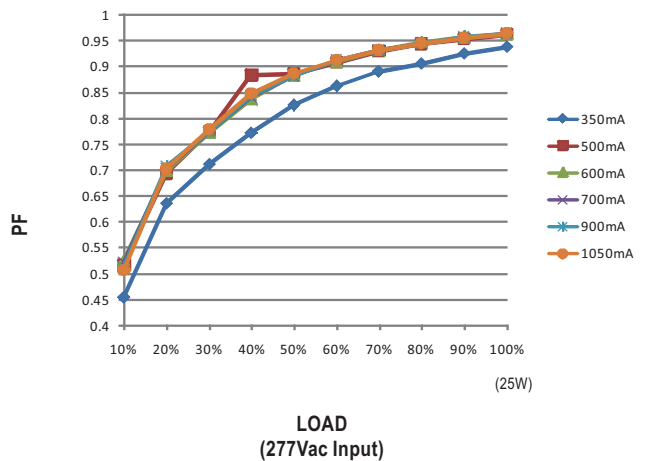
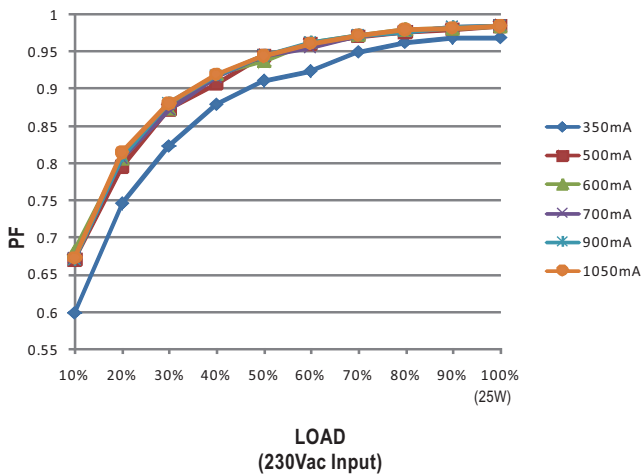

**EFFICIENCY vs LOAD**

LCM-25KN series possess superior working efficiency that up to 86% can be reached in field applications.

※ Tcase at 75°C

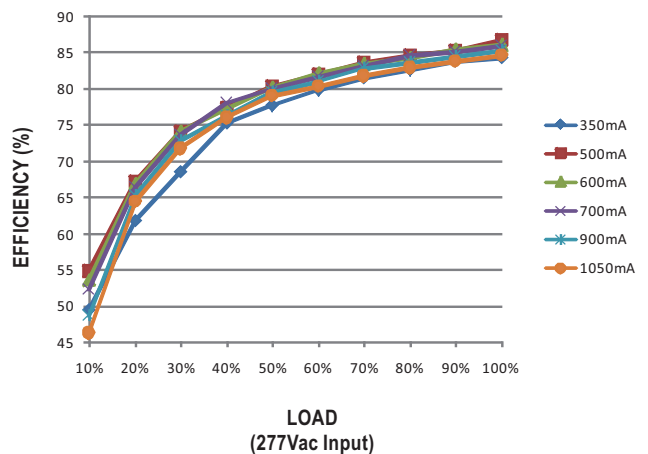
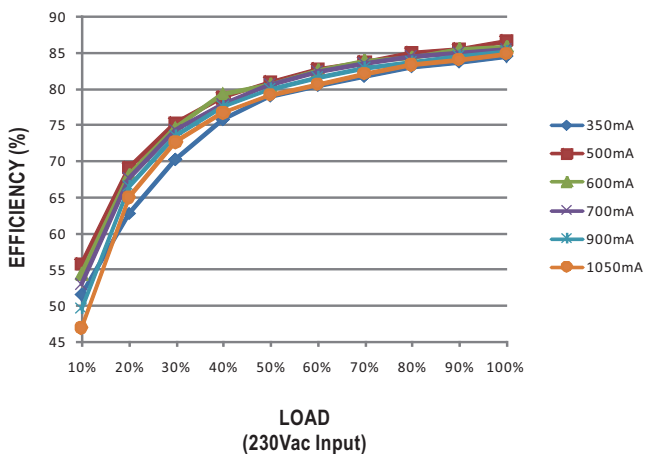

**MECHANICAL SPECIFICATION**

Case No.LCM-25 Unit:mm

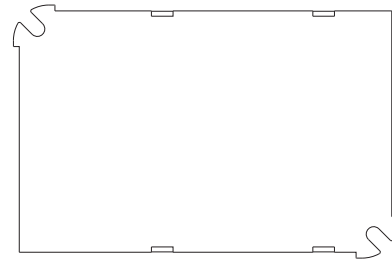
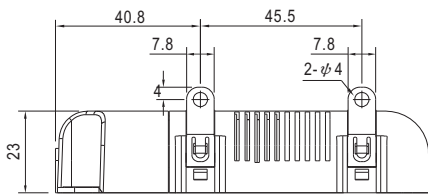
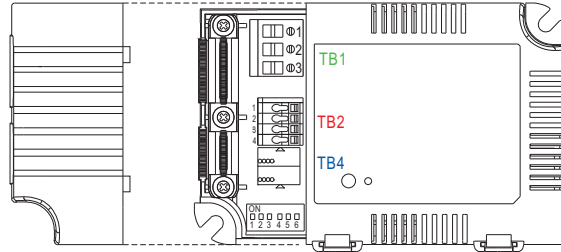
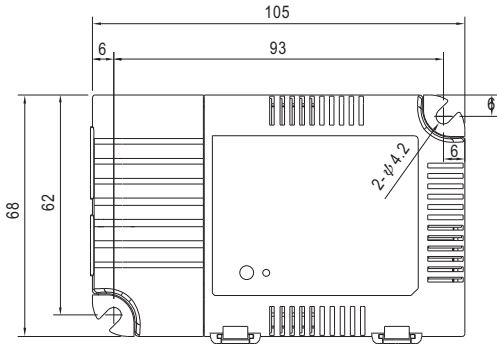

Bottom View

※ Terminal Pin No. Assignment(TB1)

Pin No.	Assignment
1	AC/L
2	AC/N
3	PUSH

※ Terminal Pin No. Assignment(TB2)

Pin No.	Assignment	Pin No.	Assignment
1	+Vo	3	-SYN.
2	-Vo	4	+SYN.

※ Terminal Pin No. Assignment(TB4)

Pin No.	Assignment
1	KNX-
2	KNX+

Note:Please use wires with a cross section of 0.5~2.5mm<sup>2</sup>(14~20AWG) for TB1 and wires with a cross section of 0.5~1.5 mm<sup>2</sup>(16~20AWG) for TB2.

**INSTALLATION MANUAL**

Please refer to : <http://www.meanwell.com/manual.html>