



### ■ Features

- Constant Voltage + Constant Current mode output
- Metal housing with class I design
- Built-in active PFC function
- IP67 / IP65 design for indoor or outdoor installations
- Function options: output adjustable via potentiometer; 3 in 1 dimming (dim-to-off, isolated design) ; smart timer dimming; junction box
- Typical lifetime > 62000 hours
- 7 years warranty (Note.9)

### ■ Applications

- LED Harbour
- LED greenhouse lighting
- LED stadium lighting
- LED mining lighting
- Type “HL” for use in Class I , Division 2 hazardous(Classified) location

### ■ Description

HLG-480H series is a 480W AC/DC LED driver featuring the dual mode constant voltage and constant current output. HLG-480H operates from 90 ~ 305VAC and offers models with different rated voltage ranging between 24V and 54V. Thanks to the high efficiency up to 95.5%, with the fanless design, the entire series is able to operate for -40°C ~ +90°C case temperature under free air convection. The design of metal housing and IP67/IP65 ingress protection level allows this series to fit both indoor and outdoor applications. HLG-480H is equipped with various function options, such as dimming methodologies, so as to provide the optimal design flexibility for LED lighting system.

### ■ Model Encoding

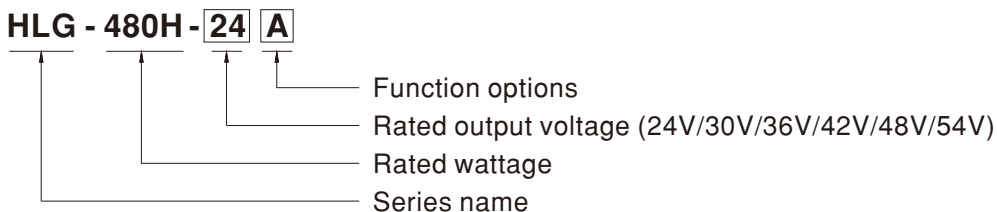

Type	IP Level	Function	Note
Blank	IP67	Io and Vo fixed	In Stock
A	IP65	Io and Vo adjustable through built-in potentiometer	In Stock
B	IP67	3 in 1 dimming function (0~10VDC, 10V PWM signal and resistance)	In Stock
AB	IP65	Io and Vo adjustable through built-in potentiometer & 3 in 1 dimming function (0~10Vdc, 10V PWM signal and resistance)	In Stock
Dx	IP67	Built-in Smart timer dimming function by user request.	By request
D2	IP67	Built-in Smart timer dimming and programmable function.	In Stock

## SPECIFICATION

MODEL		HLG-480H-24□	HLG-480H-30□	HLG-480H-36□	HLG-480H-42□	HLG-480H-48□	HLG-480H-54□	
OUTPUT	DC VOLTAGE	24V	30V	36V	42V	48V	54V	
	CONSTANT CURRENT REGION <small>Note.4</small>	12 ~ 24V	15 ~ 30V	18 ~ 36V	21 ~ 42V	24 ~ 48V	27 ~ 54V	
	RATED CURRENT	20A	16A	13.3A	11.4A	10A	8.9A	
	RATED POWER	480W	480W	478.8W	478.8W	480W	480.6W	
	RIPPLE & NOISE (max.) <small>Note.2</small>	200mVp-p	200mVp-p	250mVp-p	250mVp-p	250mVp-p	350mVp-p	
	VOLTAGE ADJ. RANGE	Adjustable for A/AB-Type only (via built-in potentiometer)						
		20.4 ~ 25.2V	25.5 ~ 31.5V	30.6 ~ 37.8V	35.7 ~ 44.1V	40.8 ~ 50.4V	45.9 ~ 56.7V	
	CURRENT ADJ. RANGE	Adjustable for A/AB-Type only (via built-in potentiometer)						
		10 ~ 20A	8 ~ 16A	6.6 ~ 13.3A	5.7 ~ 11.4A	5 ~ 10A	4.4 ~ 8.9A	
	VOLTAGE TOLERANCE <small>Note.3</small>	±1.0%	±1.0%	±1.0%	±1.0%	±1.0%	±1.0%	
LINE REGULATION	±0.5%	±0.5%	±0.5%	±0.5%	±0.5%	±0.5%		
LOAD REGULATION	±0.5%	±0.5%	±0.5%	±0.5%	±0.5%	±0.5%		
SETUP, RISE TIME <small>Note.6</small>	500ms, 80ms 115VAC/230VAC							
HOLD UP TIME (Typ.)	16ms 115VAC/230VAC							
INPUT	VOLTAGE RANGE <small>Note.5</small>	90 ~ 305VAC 127 ~ 431VDC (Please refer to "STATIC CHARACTERISTIC" section)						
	FREQUENCY RANGE	47 ~ 63Hz						
	POWER FACTOR (Typ.)	PF ≥ 0.98/115VAC, PF ≥ 0.97/230VAC, PF ≥ 0.95/277VAC @ full load (Please refer to "POWER FACTOR (PF) CHARACTERISTIC" section)						
	TOTAL HARMONIC DISTORTION	THD < 20% (@ load ≥ 40% / 115VAC, 230VAC, 277VAC) (Please refer to "TOTAL HARMONIC DISTORTION (THD)" section)						
	EFFICIENCY (Typ.)	230VAC	94%	94.5%	95%	95%	94.5%	95%
		277VAC	94.5%	95%	95.5%	95.5%	95%	95%
	AC CURRENT (Typ.)	5A / 115VAC		2.45A / 230VAC		2A / 277VAC		
	INRUSH CURRENT (Typ.)	COLD START 35A (width=1800μs measured at 50% I <sub>peak</sub> ) at 230VAC; Per NEMA 410						
LEAKAGE CURRENT	<0.75mA / 277VAC							
MAX. NO. of PSUs on 16A CIRCUIT BREAKER	2unit(circuit breaker of type B) / 3units(circuit breaker of type C) at 230VAC							
PROTECTION	OVER CURRENT	95 ~ 108% Constant current limiting, recovers automatically after fault condition is removed						
	SHORT CIRCUIT	Constant current limiting, recovers automatically after fault condition is removed						
	OVER VOLTAGE	27 ~ 33V	33 ~ 40V	40 ~ 50V	46 ~ 55V	53 ~ 63V	60 ~ 70V	
	OVER TEMPERATURE	Shut down output voltage, re-power on to recovery						
ENVIRONMENT	WORKING TEMP.	T <sub>case</sub> = -40 ~ +90°C (Please refer to "OUTPUT LOAD vs TEMPERATURE" section)						
	MAX. CASE TEMP.	T <sub>case</sub> = +90°C						
	WORKING HUMIDITY	20 ~ 95% RH non-condensing						
	STORAGE TEMP., HUMIDITY	-40 ~ +80°C, 10 ~ 95% RH non-condensing						
	TEMP. COEFFICIENT	±0.02%/°C (0 ~ 60°C)						
	VIBRATION	10 ~ 500Hz, 5G 12min./1cycle, period for 72min. each along X, Y, Z axes						
SAFETY & EMC	SAFETY STANDARDS	UL8750(type"HL"), CSA C22.2 No. 250.13-12; ENEC EN61347-1, EN61347-2-13 independent, EN62384; GB19510.14, GB19510.1; IP65 or IP67, EAC TP TC 004, AS/NZS IEC 61347.2.13:2013, AS/NZS 61347.1:2016; KC61347-1, KC61347-2-13 (except for AB, Dx, D2-type), J61347-1(H29), J61347-2-13(H29)(for Blank/A-type) approved						
	WITHSTAND VOLTAGE	I/P-O/P: 3.75KVAC I/P-FG: 2KVAC O/P-FG: 1.5KVAC						
	ISOLATION RESISTANCE	I/P-O/P, I/P-FG, O/P-FG: 100M Ohms / 500VDC / 25°C / 70% RH						
	EMC EMISSION	Compliance to EN55015, EN61000-3-2 Class C (@ load ≥ 50%) ; EN61000-3-3; GB17743, GB17625.1, EAC TP TC 020; KC KN15, KN61547(except for AB, Dx, D2-type), J55015(H29)(for Blank/A-type)						
	EMC IMMUNITY	Compliance to EN61000-4-2, 3, 4, 5, 6, 8, 11, EN61547, light industry level (surge immunity Line-Earth 4KV, Line-Line 2KV), EAC TP TC 020; KC KN15, KN61547(except for AB, Dx, D2-type), J55015(H29)(for Blank/A-type)						
OTHERS	MTBF	345.5K hrs min. Telcordia SR-332(Bellcore) ; 95.3K hrs min. MIL-HDBK-217F (25°C)						
	DIMENSION	262*125*43.8mm (L*W*H)						
	PACKING	2.8Kg; 4pcs/12.2Kg/0.55CUFT						
NOTE	<ol style="list-style-type: none"> <li>All parameters NOT specially mentioned are measured at 230VAC input, rated current and 25°C of ambient temperature.</li> <li>Ripple &amp; noise are measured at 20MHz of bandwidth by using a 12" twisted pair-wire terminated with a 0.1uf &amp; 47uf parallel capacitor.</li> <li>Tolerance : includes set up tolerance, line regulation and load regulation.</li> <li>Please refer to "DRIVING METHODS OF LED MODULE".</li> <li>De-rating may be needed under low input voltages. Please refer to "STATIC CHARACTERISTIC" sections for details.</li> <li>Length of set up time is measured at first cold start. Turning ON/OFF the driver may lead to increase of the set up time.</li> <li>The driver is considered as a component that will be operated in combination with final equipment. Since EMC performance will be affected by the complete installation, the final equipment manufacturers must re-qualify EMC Directive on the complete installation again.</li> <li>To fulfill requirements of the latest ErP regulation for lighting fixtures, this LED driver can only be used behind a switch without permanently connected to the mains.</li> <li>This series meets the typical life expectancy of &gt;62,000 hours of operation when T<sub>case</sub>, particularly (T<sub>c</sub>) point (or TMP, per DLC), is about 75°C or less.</li> <li>Please refer to the warranty statement on MEAN WELL's website at <a href="http://www.meanwell.com">http://www.meanwell.com</a></li> <li>The ambient temperature derating of 3.5°C/1000m with fanless models and of 5°C/1000m with fan models for operating altitude higher than 2000m(6500ft).</li> <li>For any application note and IP water proof function installation caution, please refer our user manual before using. <a href="https://www.meanwell.com/Upload/PDF/LED_EN.pdf">https://www.meanwell.com/Upload/PDF/LED_EN.pdf</a></li> </ol>							
※ Product Liability Disclaimer : For detailed information, please refer to <a href="https://www.meanwell.com/serviceDisclaimer.aspx">https://www.meanwell.com/serviceDisclaimer.aspx</a> File Name:HLG-480H-SPEC 2020-09-27								

## ■ BLOCK DIAGRAM

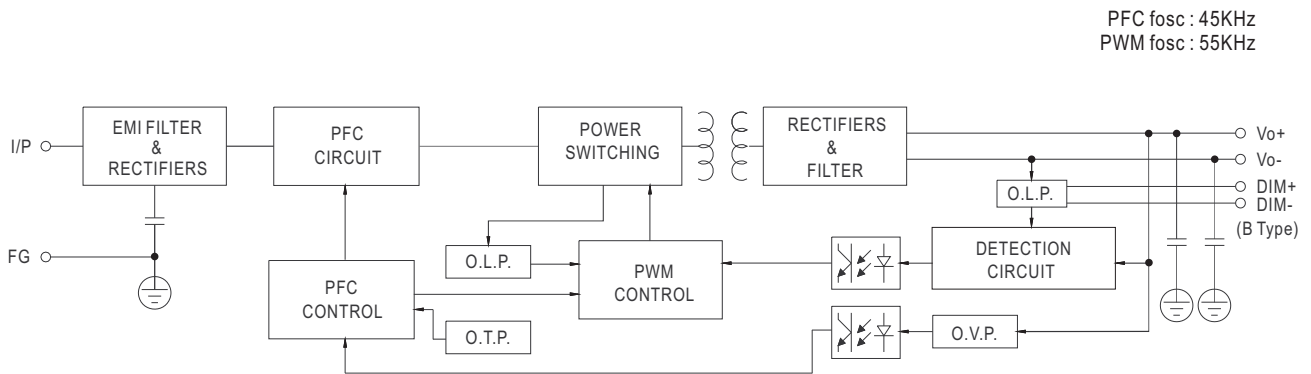

## ■ DRIVING METHODS OF LED MODULE

※ This series is able to work in either Constant Current mode (a direct drive way) or Constant Voltage mode (usually through additional DC/DC driver) to drive the LEDs.

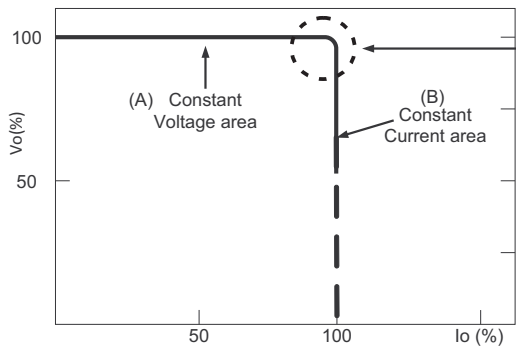

Typical output current normalized by rated current (%)

In the constant current region, the highest voltage at the output of the driver depends on the configuration of the end systems.  
Should there be any compatibility issues, please contact MEAN WELL.

## DIMMING OPERATION

For 24V,30V,36V,42V

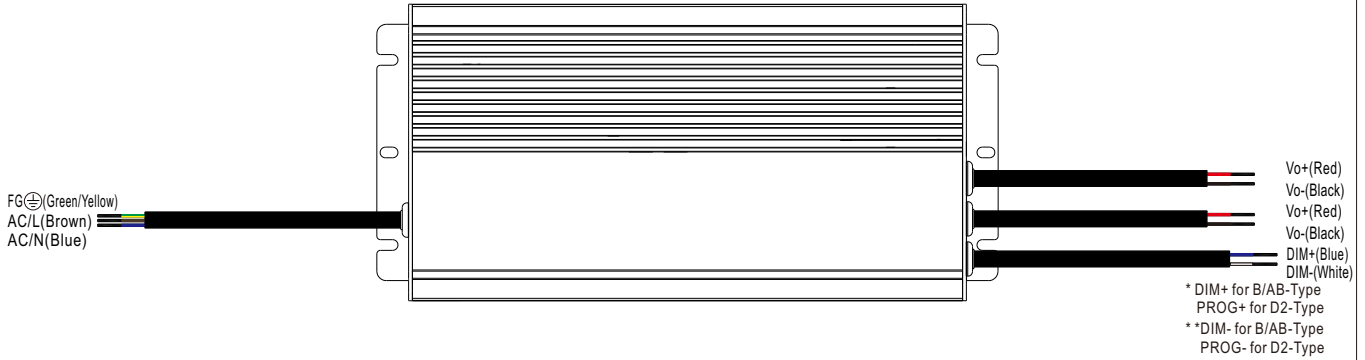

For 48V,54V

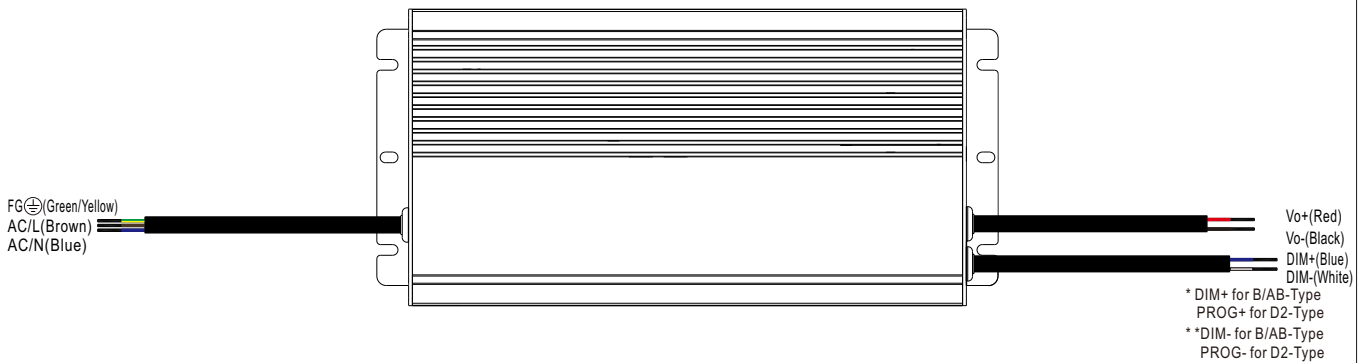

### ※ 3 in 1 dimming function (for B/AB-Type)

- Output constant current level can be adjusted by applying one of the three methodologies between DIM+ and DIM-:  
0 ~ 10VDC, or 10V PWM signal or resistance.
- Direct connecting to LEDs is suggested. It is not suitable to be used with additional drivers.
- Dimming source current from power supply: 100 $\mu$ A (typ.)

◎ Applying additive 0 ~ 10VDC

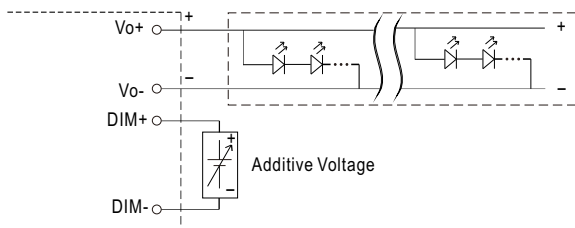

"DO NOT connect "DIM- to Vo-"

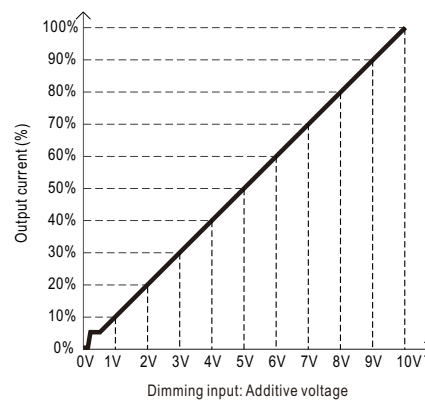

◎ Applying additive 10V PWM signal (frequency range 100Hz ~ 3KHz):

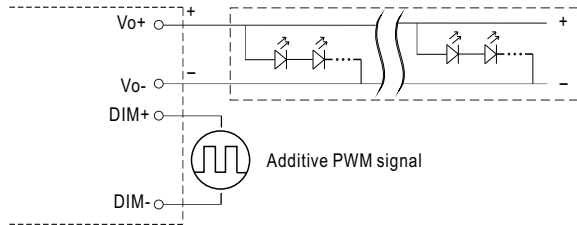

"DO NOT connect "DIM- to Vo+"

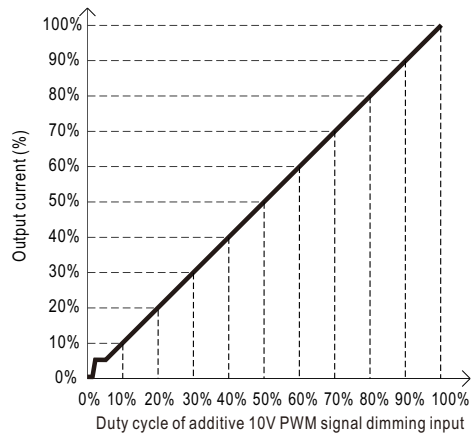

◎ Applying additive resistance:

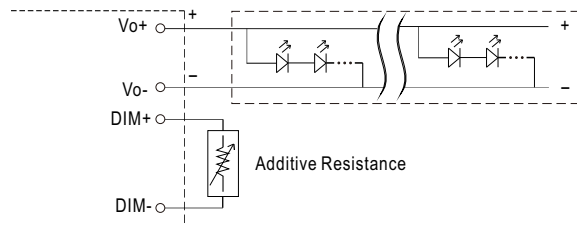

"DO NOT connect "DIM- to Vo-"

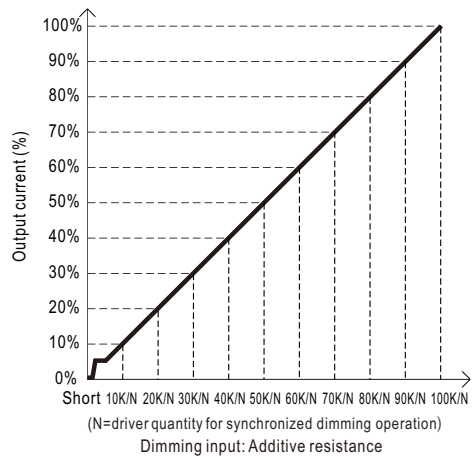

- Note : 1. Min. dimming level is about 6% and the output current is not defined when  $0% < I_{out} < 6%$ .  
 2. The output current could drop down to 0% when dimming input is about  $0k\Omega$  or 0Vdc, or 10V PWM signal with 0% duty cycle.

※ **Smart timer dimming function (for Dxx-Type by User definition)**

MEAN WELL Smart timer dimming primarily provides the adaptive proportion dimming profile for the output constant current level to perform up to 14 consecutive hours. 3 dimming profiles hereunder are defined accounting for the most frequently seen applications. If other options may be needed, please contact MEAN WELL for details.

Ex : ☉ D01-Type: the profile recommended for residential lighting

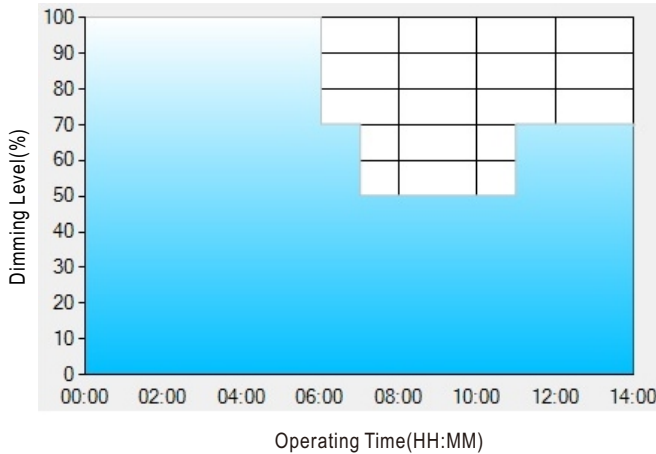

Set up for D01-Type in Smart timer dimming software program:

	T1	T2	T3	T4
TIME**	06:00	07:00	11:00	---
LEVEL**	100%	70%	50%	70%

\*\* : TIME matches Operating Time in the diagram whereas LEVEL matches Dimming Level.

Example: If a residential lighting application adopts D01-Type, when turning on the power supply at 6:00pm, for instance:

- [1] The power supply will switch to the constant current level at 100% starting from 6:00pm.
- [2] The power supply will switch to the constant current level at 70% in turn, starting from 0:00am, which is 06:00 after the power supply turns on.
- [3] The power supply will switch to the constant current level at 50% in turn, starting from 1:00am, which is 07:00 after the power supply turns on.
- [4] The power supply will switch to the constant current level at 70% in turn, starting from 5:00am, which is 11:00 after the power supply turns on.

The constant current level remains till 8:00am, which is 14:00 after the power supply turns on.

Ex : ☉ D02-Type: the profile recommended for street lighting

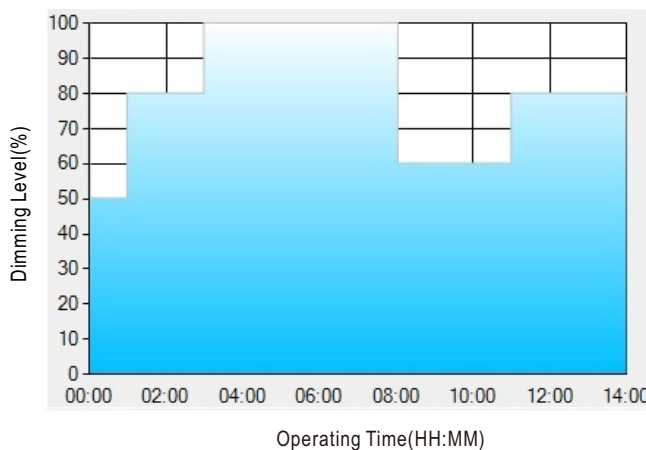

Set up for D02-Type in Smart timer dimming software program:

	T1	T2	T3	T4	T5
TIME**	01:00	03:00	8:00	11:00	---
LEVEL**	50%	80%	100%	60%	80%

\*\* : TIME matches Operating Time in the diagram whereas LEVEL matches Dimming Level.

Example: If a street lighting application adopts D02-Type, when turning on the power supply at 5:00pm, for instance:

- [1] The power supply will switch to the constant current level at 50% starting from 5:00pm.
- [2] The power supply will switch to the constant current level at 80% in turn, starting from 6:00pm, which is 01:00 after the power supply turns on.
- [3] The power supply will switch to the constant current level at 100% in turn, starting from 8:00pm, which is 03:00 after the power supply turns on.
- [4] The power supply will switch to the constant current level at 60% in turn, starting from 1:00am, which is 08:00 after the power supply turns on.
- [5] The power supply will switch to the constant current level at 80% in turn, starting from 4:00am, which is 11:00 after the power supply turns on. The constant current level remains till 6:30am, which is 14:00 after the power supply turns on.

Ex: ☉ D03-Type: the profile recommended for tunnel lighting

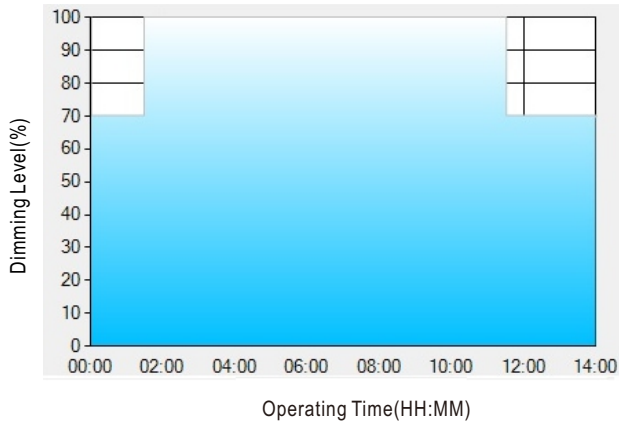

Set up for D03-Type in Smart timer dimming software program:

	T1	T2	T3
TIME**	01:30	11:00	---
LEVEL**	70%	100%	70%

\*\*: TIME matches Operating Time in the diagram whereas LEVEL matches Dimming Level.

Example: If a tunnel lighting application adopts D03-Type, when turning on the power supply at 4:30pm, for instance:

[1] The power supply will switch to the constant current level at 70% starting from 4:30pm.

[2] The power supply will switch to the constant current level at 100% in turn, starting from 6:00pm, which is 01:30 after the power supply turns on.

[3] The power supply will switch to the constant current level at 70% in turn, starting from 5:00am, which is 11:00 after the power supply turns on.

The constant current level remains till 6:30am, which is 14:00 after the power supply turns on.

### OUTPUT LOAD vs TEMPERATURE(Notes.10)

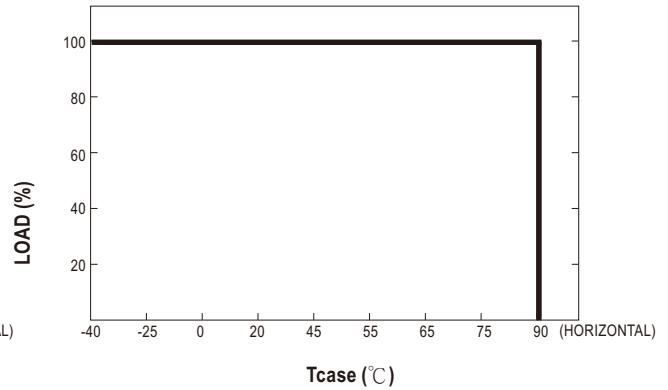
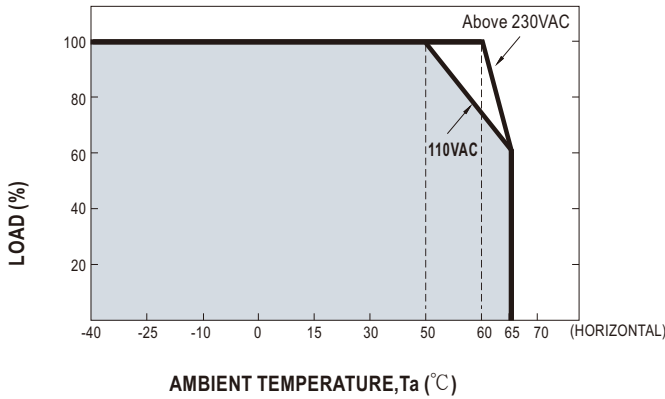

© If HLG-480H operates in constant current mode with the rated current, the maximum workable Ta is 60°C. (Typ. 230VAC)

### STATIC CHARACTERISTICS

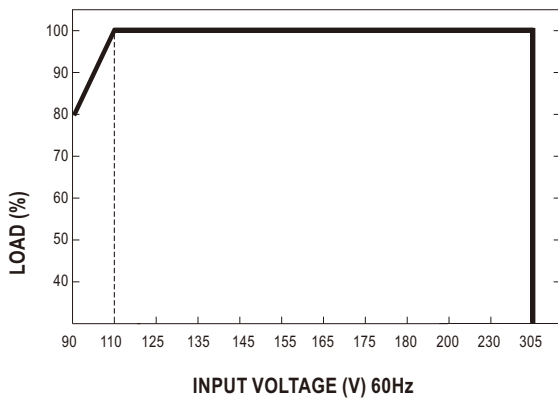

### POWER FACTOR(PF) CHARACTERISTIC

※ Tcase at 75°C

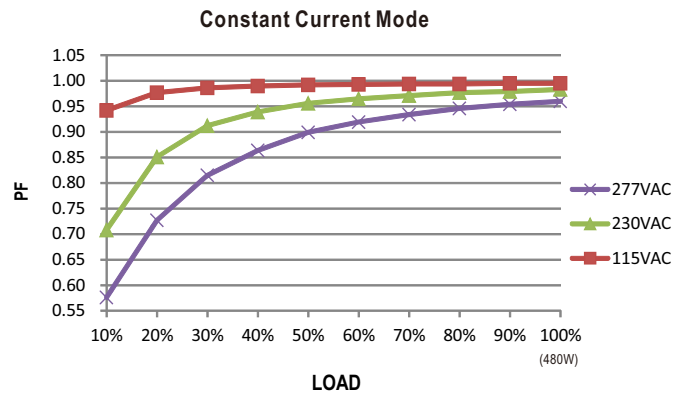

### TOTAL HARMONIC DISTORTION (THD)

※ 42V Model, Tcase at 75°C

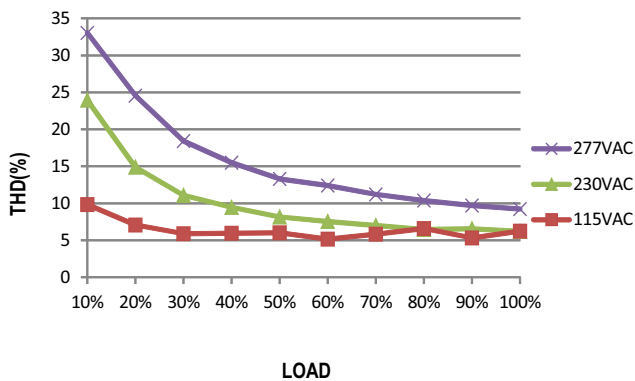

### EFFICIENCY vs LOAD

HLG-480H series possess superior working efficiency that up to 95.5% can be reached in field applications.

※ 42V Model, Tcase at 75°C

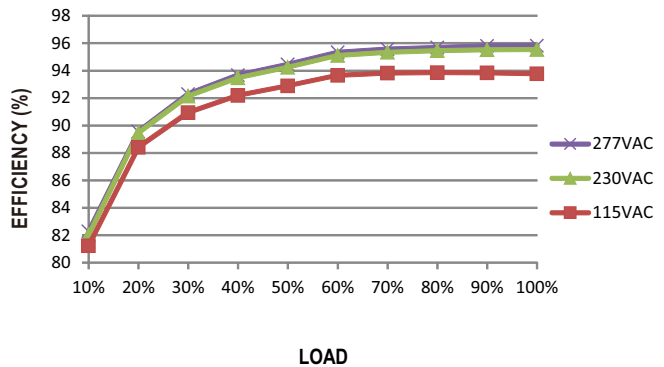





■ LIFE TIME

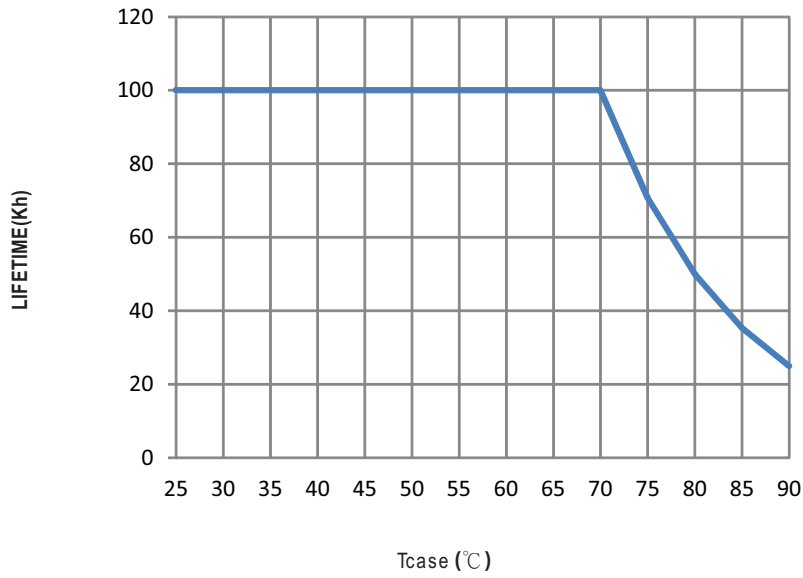

**MECHANICAL SPECIFICATION**

Case No. 251 Unit:mm

※Blank-Type

For 24V,30V,36V,42V

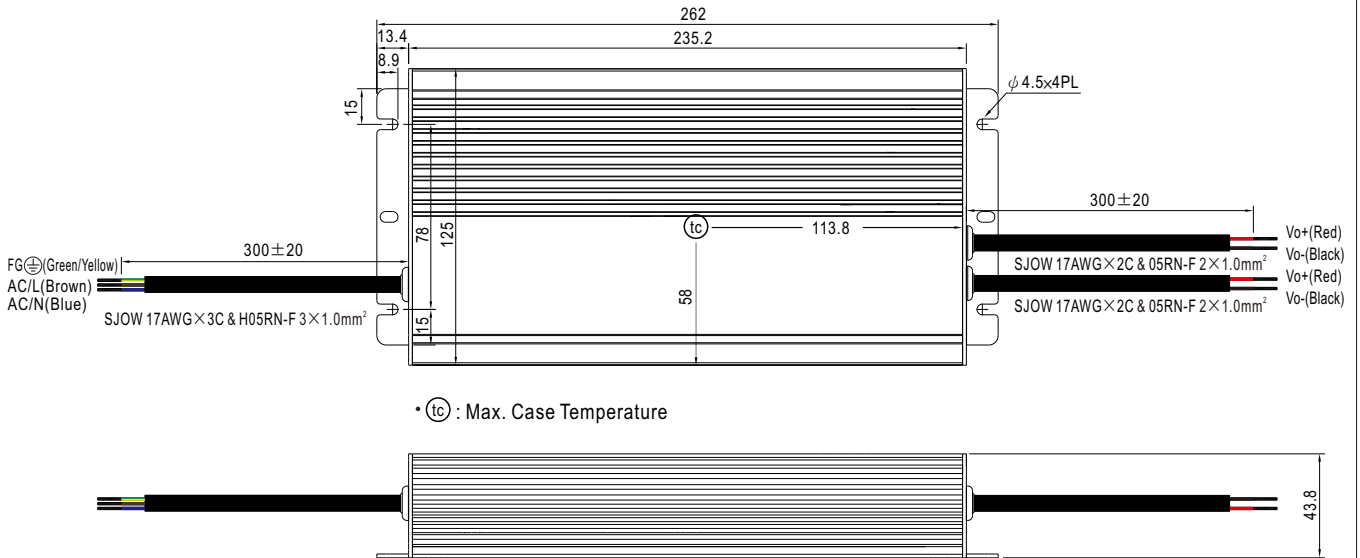

For 48V,54V

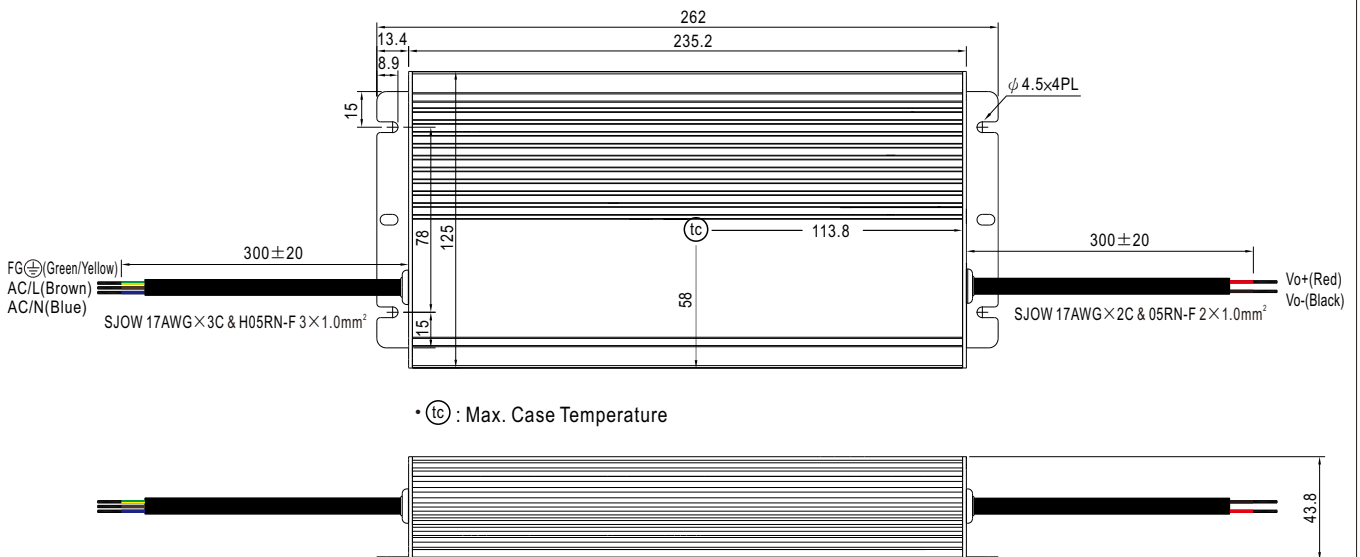

※A-Type

For 24V,30V,36V,42V

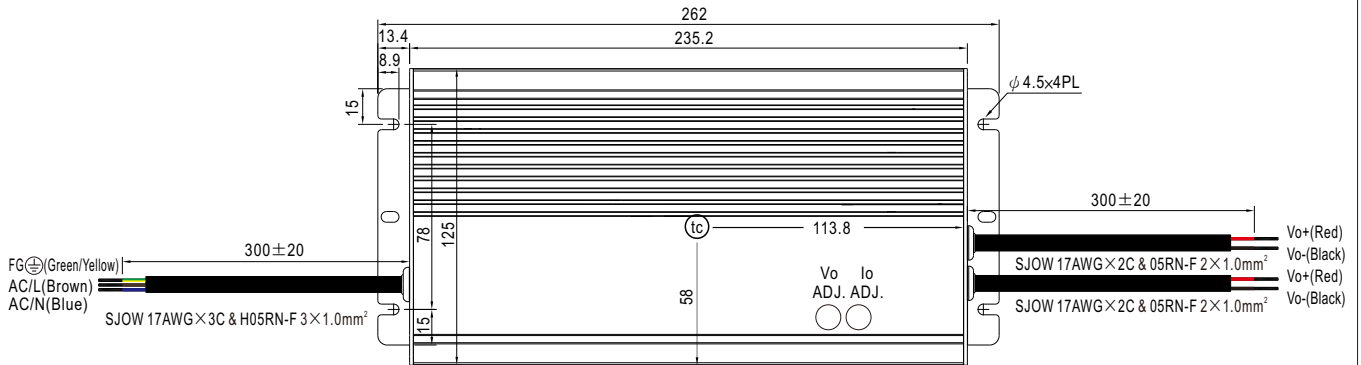

• (tc) : Max. Case Temperature

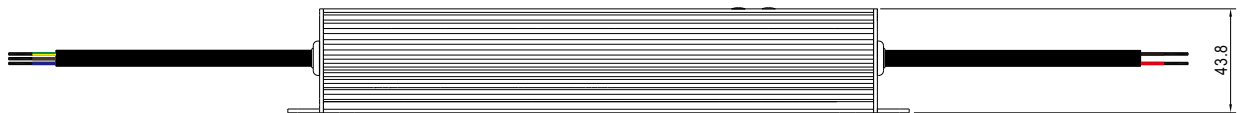

For 48V,54V

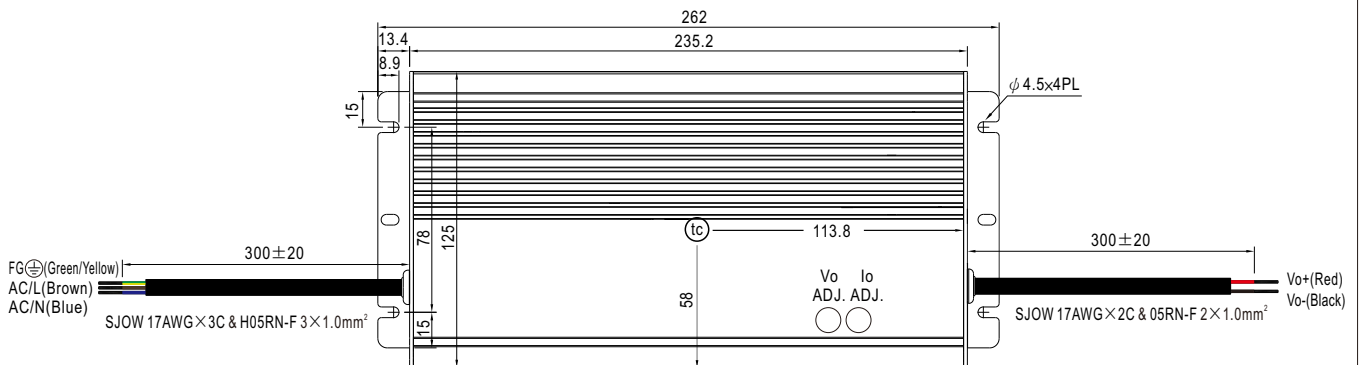

• (tc) : Max. Case Temperature



※B/D2-Type

For 24V,30V,36V,42V

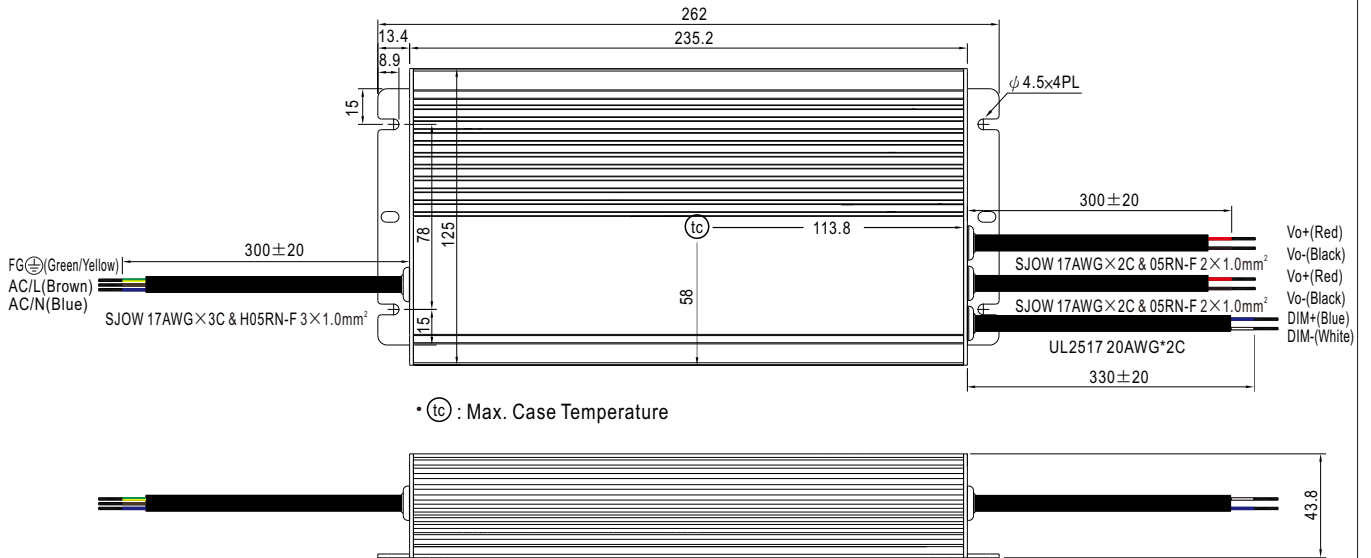

For 48V,54V

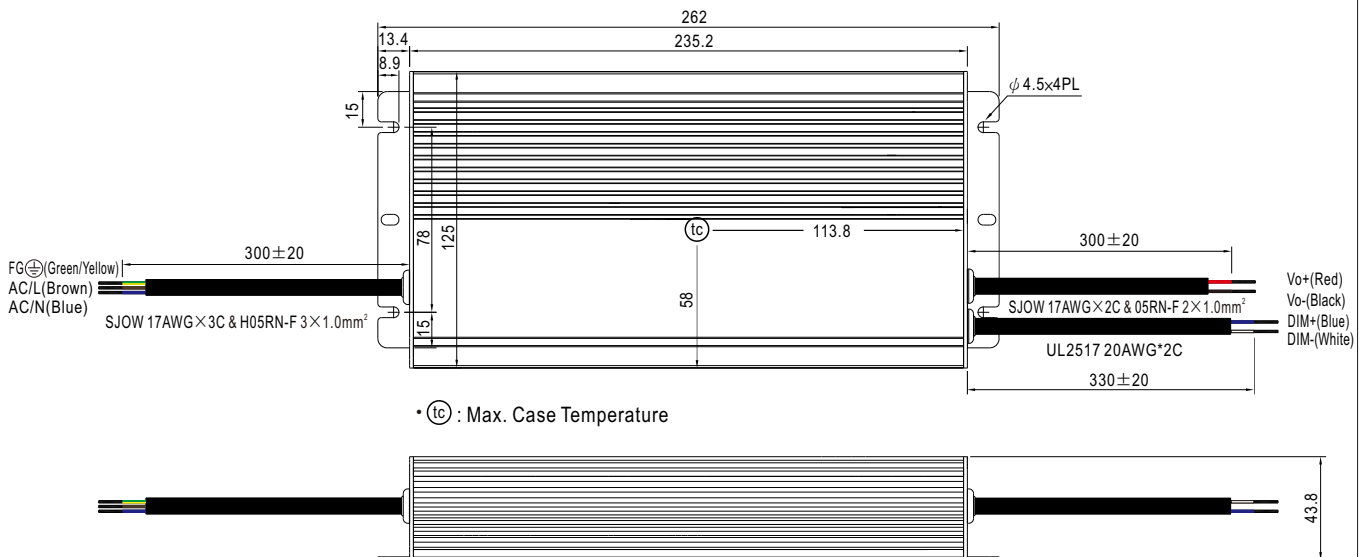

※AB-Type

For 24V,30V,36V,42V

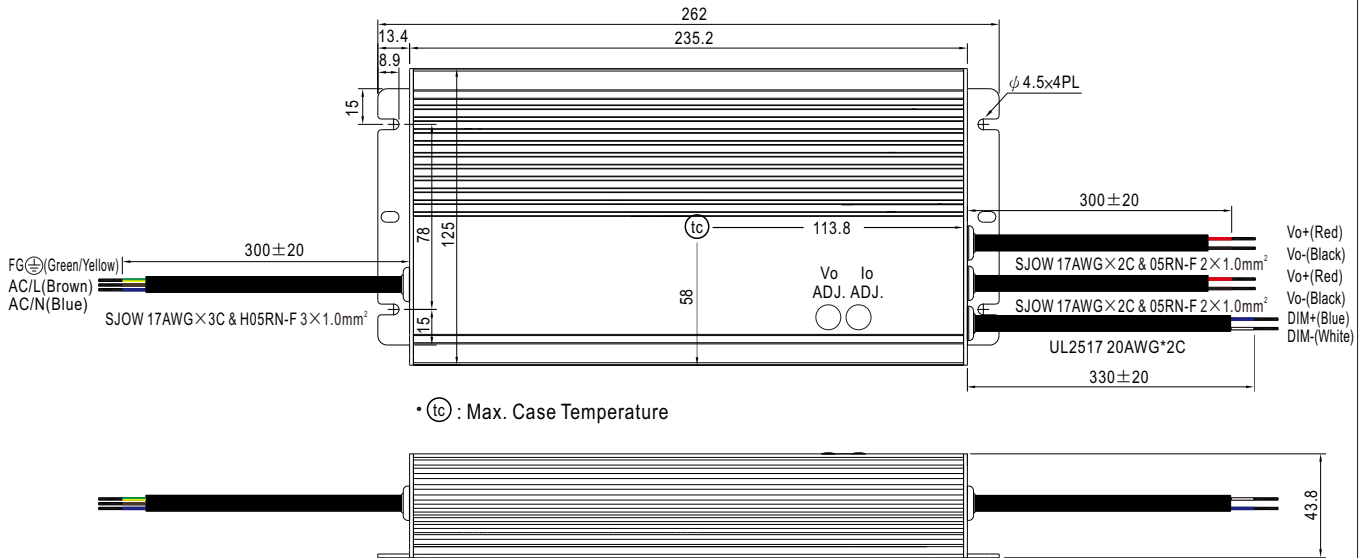

For 48V,54V

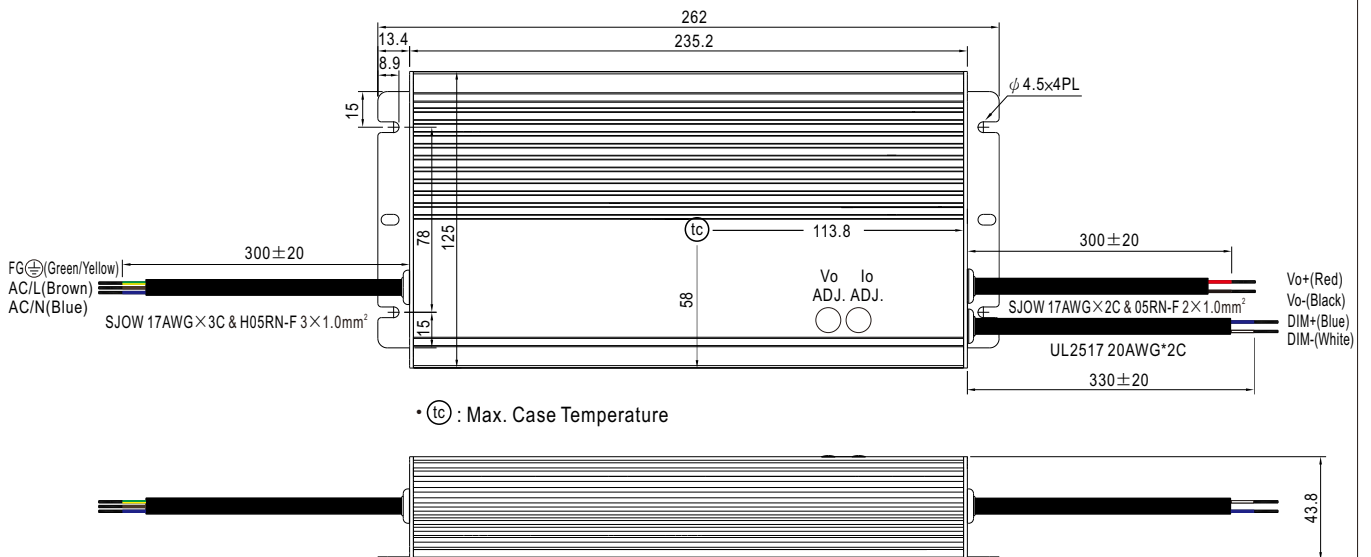

※ Junction Box Option

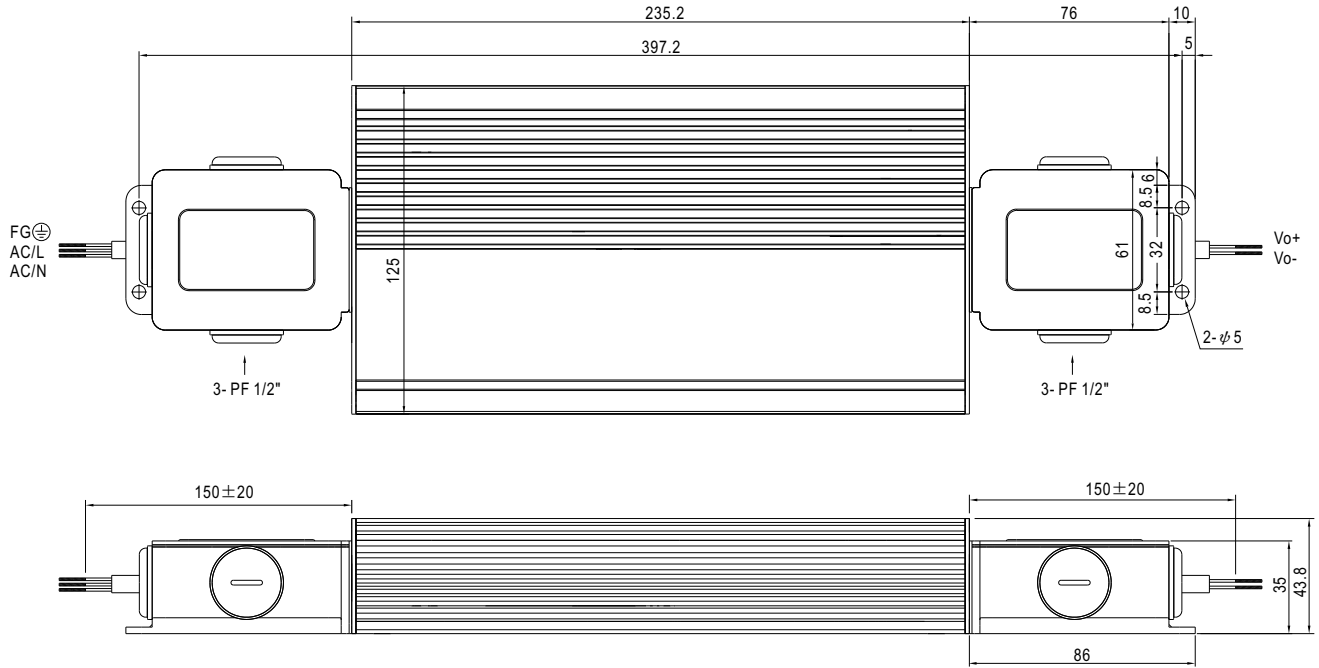

© Junction box option is available for all types. Please contact MEAN WELL for details.

■ INSTALLATION MANUAL

Please refer to : <http://www.meanwell.com/manual.html>