

# PROFIL LED HIDE10 C4 PLUS 2000 ANOD.







Architektoniczne



max 10 mm

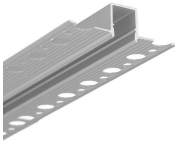

do szpachlowania

	<ul style="list-style-type: none"><li>• profil mieszczący się w grubości standardowej płyty kartonowo-gipsowej (12,5 mm)</li><li>• ciągła linia światła przy użyciu taśmy 120 P/m</li></ul>	<ul style="list-style-type: none"><li> Wzory przemysłowe EU</li><li> CE</li><li> Wyprodukowane w Polsce</li></ul>	 <p>Kup produkt</p>
---	---	--	--

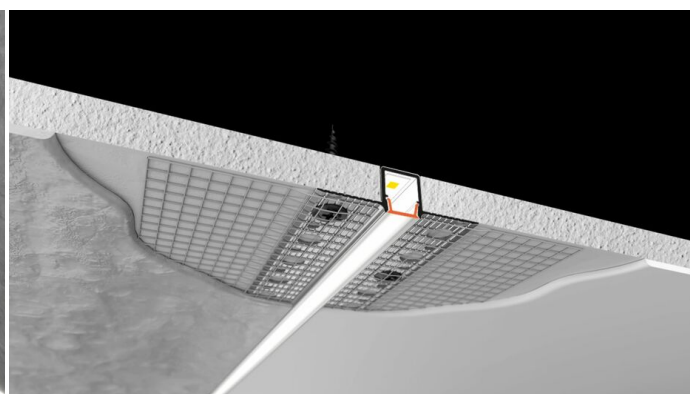
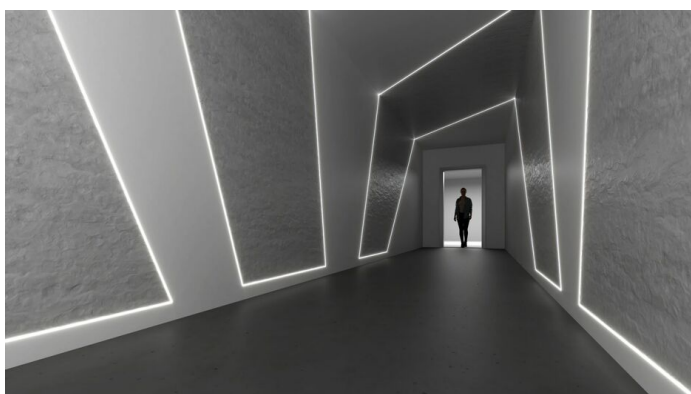
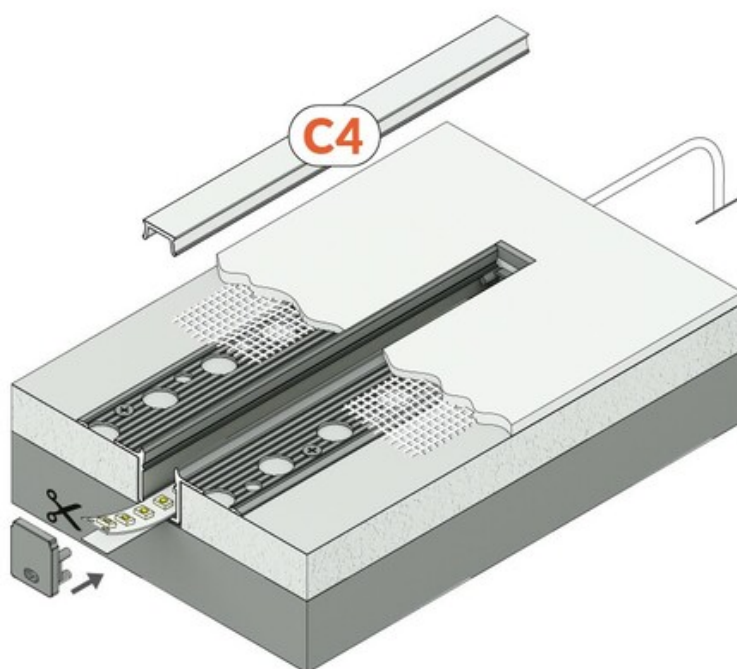

## Informacje podstawowe

Indeks: H7001020 EAN: 5901597297901 Materiał: aluminium Kolor: anodowany Długość [mm]: 2000 Szerokość [mm]: 50.4 Wysokość [mm]: 14.7 Waga [kg]: 0.438 Producent: TOPMET Kraj pochodzenia, wytworzenia: PL	Jednostka miary: szt. Wymiary opakowania jednostkowego [mm]: 2000 x 50,4 x 14,7 Opakowanie zbiorcze [szt]: 40 Typ opakowania zbiorczego: pakiet Waga produktu z opakowaniem zbiorczym [kg]: 17.52
--	---

## DOSTĘPNE KOLORY

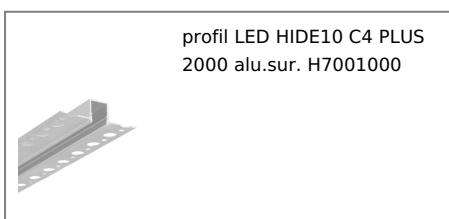

## DOSTĘPNE WARIANTY

1000 mm, 2000 mm, 3000 mm, 4050 mm

## Dopasowane elementy

### KLOSZE DO PROFILI LED



### ZAŚLEPKI DO PROFILI LED



**zaślepka HIDE10 z  
otworem szary [20szt]**  
index: H7999922