

ATTACCHI SALDOBRASATI 97

MARCHIO  CAT. I

N°2 ODS 18 (Øi 18.2)

N°2 ODS 12 (Øi 12.2)

ETICHETTA (IN)

ETICHETTA

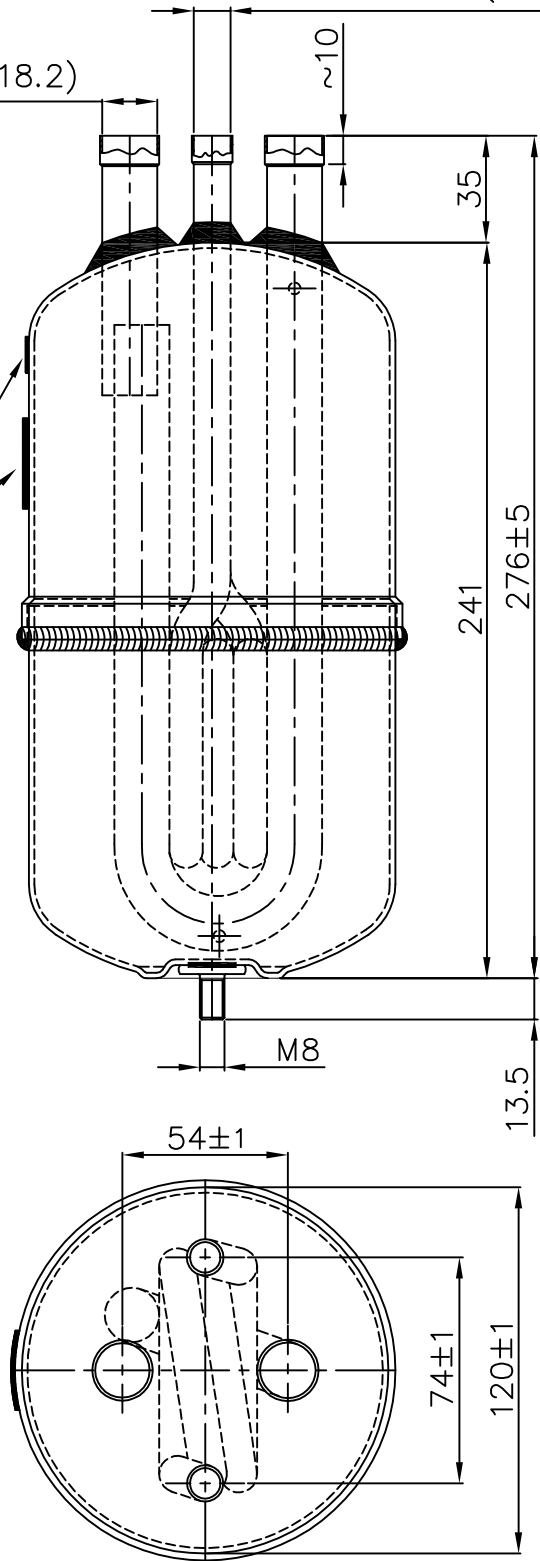



RESISTENZA ALLA CORROSIONE IN NEBBIA SALINA 504 ORE / SALT SPRAY TEST CORROSION RESISTANCE 504 HOURS





A TERMINI DELLE VIGENTI LEGGI SUI DIRITTI D'AUTORE, IL PRESENTE DISEGNO NON POTRA', ESSERE COPIATO, RIPRODOTTO O CONSEGNATO A TERZI ED A DITTE CONCORRENTI.

TOLLERANZE PER FORATURE ATTACCHI ±0.2

VERNICIATURA	colore <u>NERO</u>
RAL <u>9005</u>	POLV. <input checked="" type="checkbox"/> LIQ. <input type="checkbox"/>

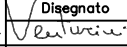
		LEGNAGO VERONA - Italy I-37045			
Type:	05/S-S-34-ODS 18/12				
Manufacture-	Nr.				
Manufacture year					
Fluids Group	2	/	Escluded	/	
Category	1	/	Volume V:L	2.3	
Temperature TS-°C	-10	120	-50	120	
Max. Permissible pressure PS-bar:	34	25			
Test pressure PT-bar:	48.62				

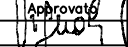
DICHIARAZIONE DI CONFORMITA': 404.0403.A

2	1	IM	SOSTITUISCE		MATERIALE		PESO	
			SOSTITUITO		PED-2014/68/UE			
SOSTITUITO CALOTTA SUPERIORE, ERA CODICE 3030025A	Carli M.	FIRMA	Data	Disegnato	Controllato	Approvato	NOTE SENZA INDICAZIONE DI TOLLERANZA SECONDO PROCEDURA INTERNA PRO5	
			13/01/2014				SCALA 1:1	PROIEZIONE 
07/06/2021	DATA	MODIFICHE	Firme	VENTURINI	CATTIVELLI	VIGNOLI		
					TIPO		SEPAR./SCAMB. DI LIQUIDO A NORME PED - (CE)	
			COSTRUZIONE COMPONENTI REFRIGERAZIONE CONDIZIONAMENTO		MODELLO		Ø120X276	
			S.PIETRO DI LEGNAGO (VR) TEL. ++39 0442 629006 FAX. ++39 0442 629091 www.frigomec.com / Email: frigomec@tin.it		CODICE		100.0564.P	
							FOGLIO 1/2	