

# FLOWERPOT A

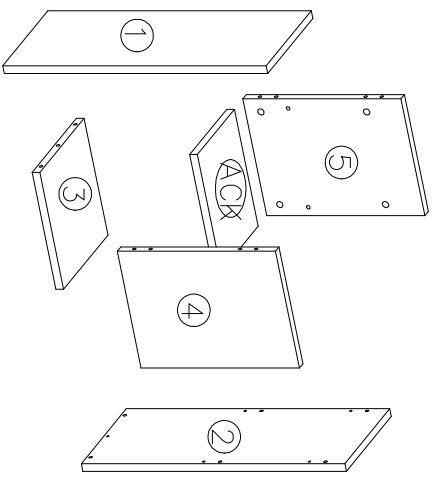

8.0x35	8.0x20	8.0x20	10	10	10	4
B	B1	C	D	D1	D	G
12	4	10	10	10	4	

10	C
----	---

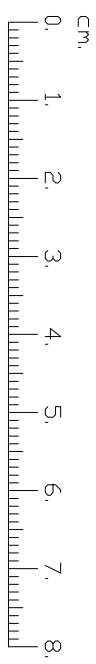
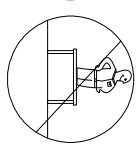
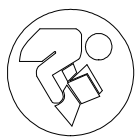
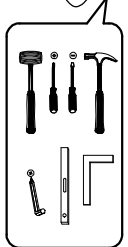
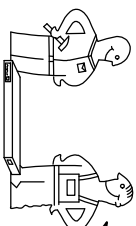
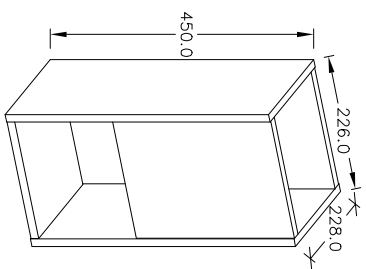
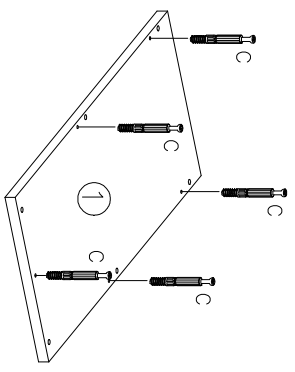
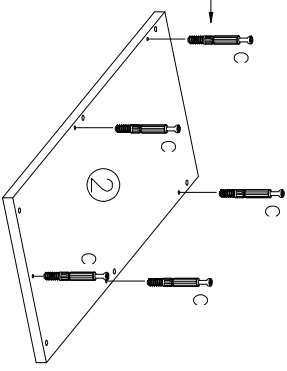
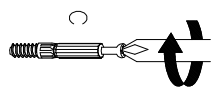

8.0x35	8.0x20	10
B	B1	D
12	4	10

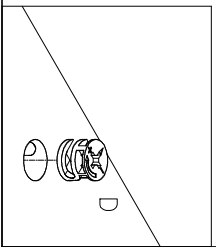
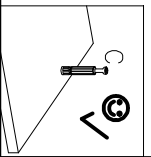
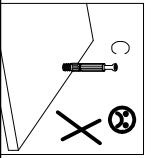
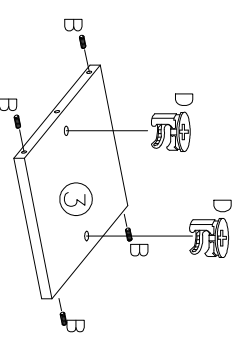
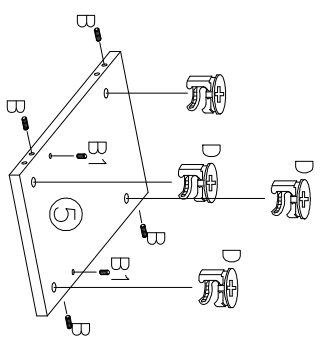
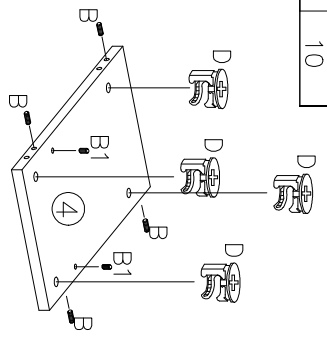

5

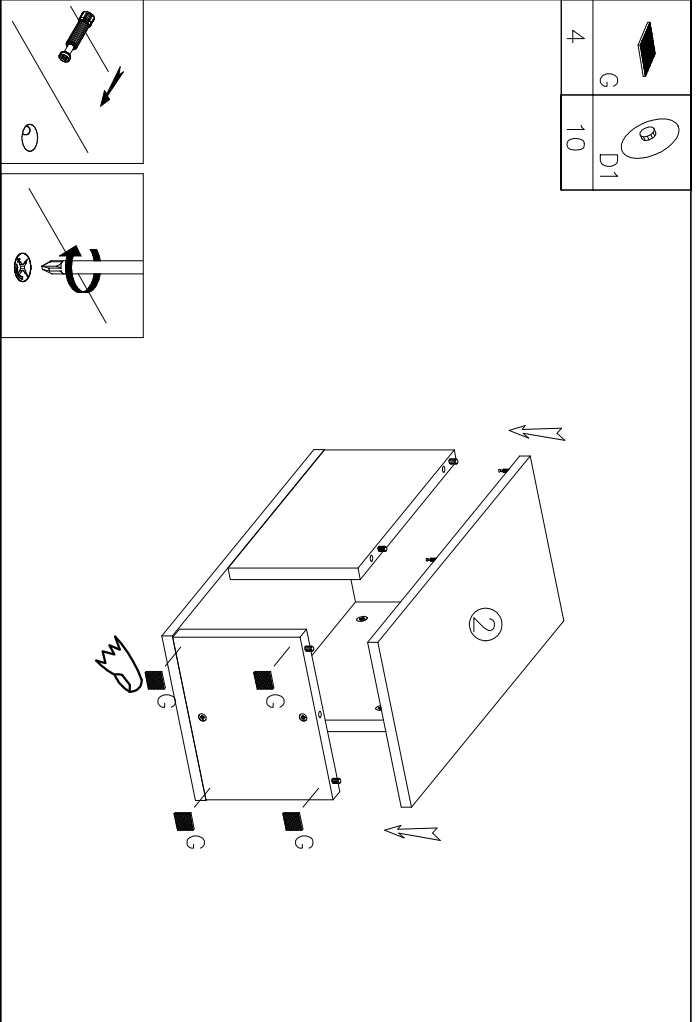
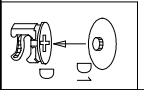

3

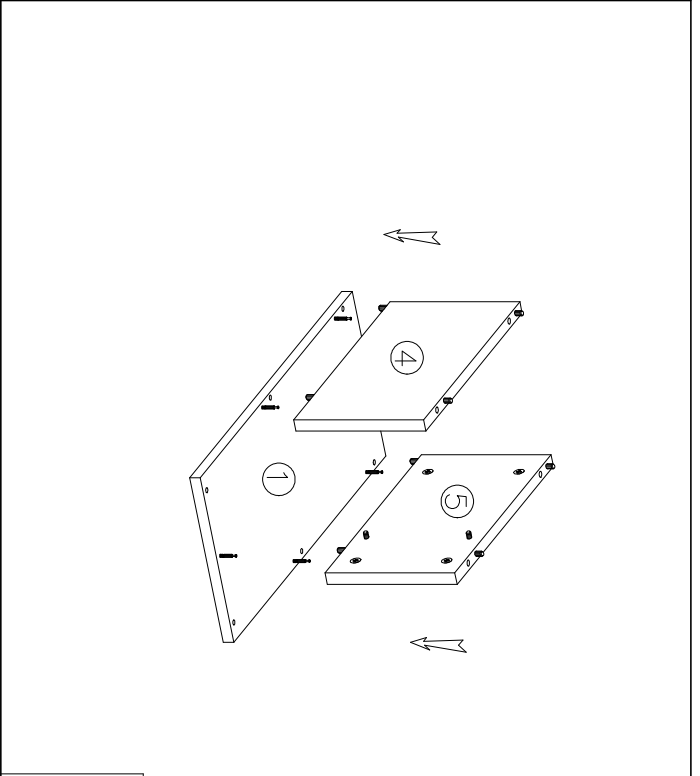
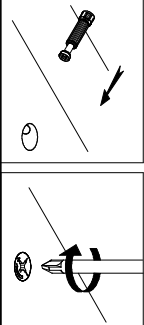

6

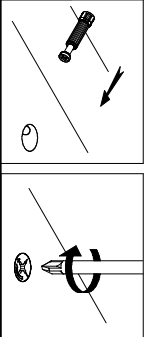

4

