

V1.0

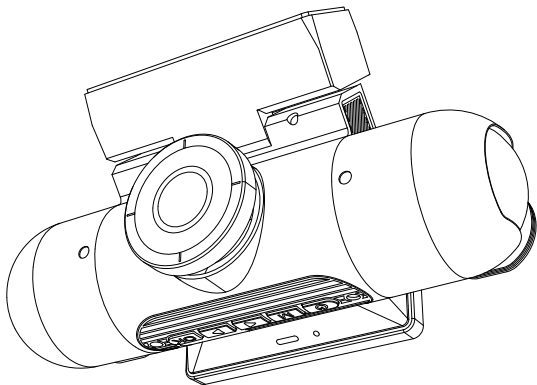

**REDTIGER**

Truly Peace of Mind



**Dash Cam**  
**VisionPano40**  
User Manual

[redtigercam.com](http://redtigercam.com)

The information in this manual is subject to change without notice.



# Content

Notice . . . . .	2
Product Specifications . . . . .	3
Package Contents . . . . .	4
Appearance . . . . .	5
Touch Screen Function . . . . .	6
Buttons and Functions . . . . .	9
Voice Control Function . . . . .	11
User Interface Overview . . . . .	12
Function Overview . . . . .	15
OTA(Over the air) Update . . . . .	18
How to Play Video on Computer . . . . .	18
Installation . . . . .	20
Trouble Shooting . . . . .	24
Customer Service Center . . . . .	26

## Notice

- Please read this manual carefully before operation and keep it for future reference. It will be helpful should you encounter any operational problem.
- Improper installation will void the manufacturer's warranty. The installation instructions do not apply to all types of vehicles and are written as guidelines to assist in installing the system.
- Consult an experienced technician if you are not comfortable installing the product.
- Please make sure to read and understand local laws and regulations regarding cameras and their use in a vehicle. Laws vary by state.
- Do not obscure the view of the road ahead or impede the deployment of any airbags in the event of an accident.
- When not in use, please disconnect the car adapter from both the 12/24V DC outlet in your vehicle and the device itself.
- Only clean the device with a soft dry cloth, for tough dirt, apply some neutral detergent diluted in 5 to 6 parts water on a soft cloth.
- Note that alcohol, thinner, benzene, etc could cause damage to the paint or coatings.
- Avoid making contact with the lens as this may cause damage.
- The video recordings made by this Digital Video Recorder are intended for personal use only.
- While driving, do not adjust the controls of your device as this is a distraction to driving.

## Product Specifications

Item Name	VisionPano40 Dash Cam	Video Format	MP4
Screen Size	2.35" IPS	Photo Format	JPG
Recording Resolution	Front 2.5K@30fps+Front Left 1080P@30fps+ Front Right 1080P@30fps+Rear 2.5K@30fps		
Lens	F1.5	Input	DC 12V/24V
Operating Temperature	-4°F~158°F	Output	DC 5V-2.5A
Micro SD card	Max Support 512GB	Warranty Period	18 Months

### Note:

In the event of a problem during use, we will offer 18 months free warranty from the date of purchase, in addition to lifetime technical support.

\* The specific warranty period is subject to local laws.

### Extended Warranty Service:

After registering information on [redtigercam.com](http://redtigercam.com), you may extend the warranty for an additional 6 months free of charge.

URL: <https://www.redtigercam.com/pages/warranty-form>

## Package Contents

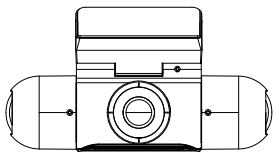

• VisionPano40 2K

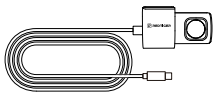

• 2.5K Rear Camera

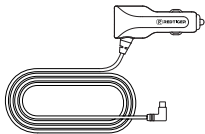

• Power Supply Cable  
with Car Charger

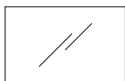

• Electrostatic  
Sticker \*2



• Adhesive



• User Manual



• Tool



• Cable Clips\*5

## Appearance

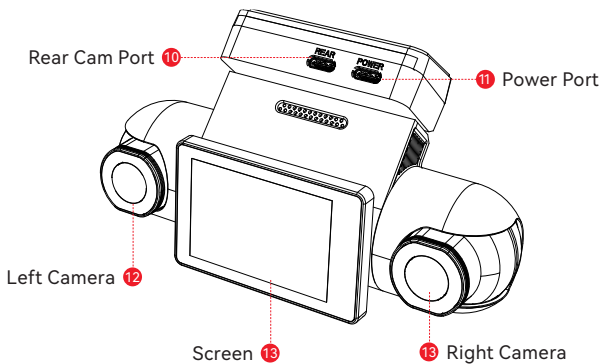
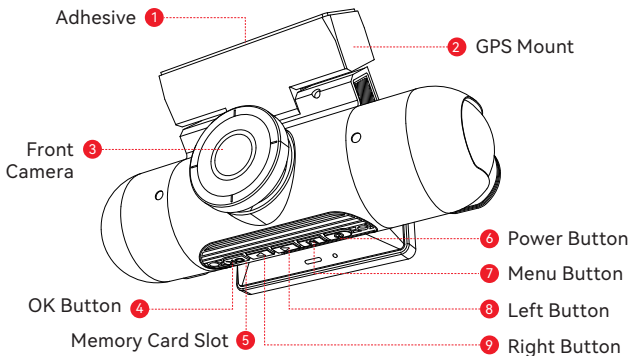

## Touch Screen Function

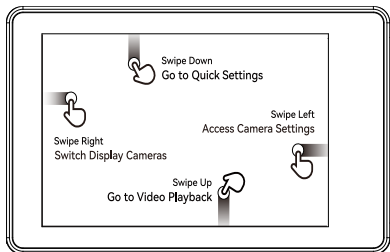

- **Switching Recording Scenes**



Swipe the screen from left to right to switch recording scenes.

## • Quick Setting Mode

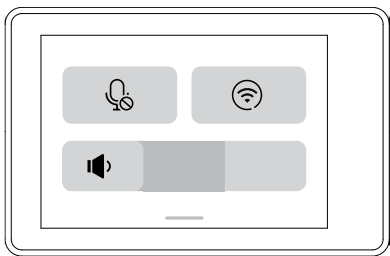

Swipe down to enter the quick setting mode you can conveniently adjust the volume, turn on or off the recording and Wi-Fi.

## • Video Mode

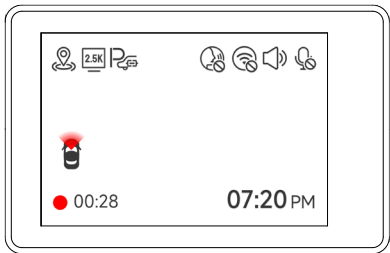

You can manually click the icon  at the top of the screen to choose whether to record audio during video recording.

You can manually click the icon  at the top of the screen to choose whether to turn on the key sound.

You can manually click the icon  at the top of the screen to choose whether to turn on Wi-Fi.

You can manually click the icon  at the top of the screen to choose whether to turn on the Voice control.

## • Playback Mode

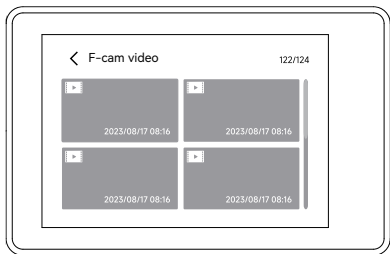

Swipe up the recording page to enter playback mode. Swipe up on the playback interface to turn pages. You can click on any video to play it back.

## • Setting Mode

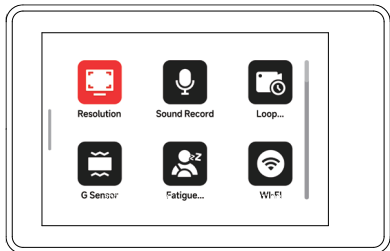

Swipe right on the recording page to enter setting mode. Swipe up and down on the menu interface to turn pages. Click on any function icon to touch the screen.

## Buttons and Functions



### Power Button

Recording Mode:

- Short press-to Take a snapshot
- Long press-to Turn off the Camera

Setup Mode:

- Short press-to Return to the previous screen

Playback Mode:

- Short press-to Return to the previous screen



### Menu Button

Recording Mode:

- Short press to Enter main menu
- Long press-to Turn on/off WiFi

Setup Mode:

- Short press-to Enter screen saver display

Playback Mode:

- Short press-to Delete/Lock/Unlock the specific file



### Left Button

Recording Mode:

- Short press-to Lock/Unlock the recording file

Setup Mode:

- Short press-to Select the previous function

Playback Mode:

- Short press-to Fast rewind while video being played



## **Right Button**

Recording Mode:

- Short press-to Enter playback mode

Setup Mode:

- Short press-to Select the next function

Playback Mode:

- Short press-to Select the next file
- Short press-to Fast forward while video is being played

The letters "OK" in a bold, black, sans-serif font inside a light gray rounded square.

## **OK Button**

Recording Mode:

- Short press-to Switch screen

Setup Mode:

- Short press-to Enter/Confirm specific settings

Playback Mode:

- Short press-to Select and play the specific file

## Voice Control Function

Fast control through simple voice commands

If the icon is white , it means the function can be used normally.

You have two ways to enable this feature.

- 1 Tap on the icon to turn the feature on or off.
- 2 Enter the setting mode-voice control-on/off.

lock the video	
take picture	
turn on Audio	turn off Audio
turn on screen	turn off screen
turn on wifi	turn off wifi
turn on recording	turn off recording
show front camera	show rear camera







### Note:

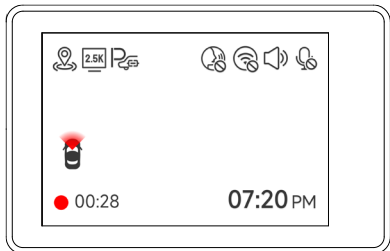



You can see the specific commands in setting-voice control.

# User Interface Overview

## • Recording Mode



Icon	Description
	GPS status
	Recording resolution
	Whether to connect the hardwired kit and set up parking monitoring
	Voice control
	Wi-Fi status
	Voice control

Icon	Description
	Voice recording status
	Which camera is being displayed
	Recording status and recording time
	Emergency recording is on
	Date and time of the camera

- **Playback Mode**

- 1 Press the **M** button to access the playback folder.
- 2 Press the Left or Right button to select the folder you want to play, then press the **M** button to enter.

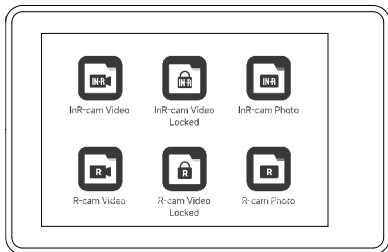

- 3 Press the **OK** button to watch the recorded video.
- 4 Long press the **OK** button for 3 seconds to edit your recorded videos.

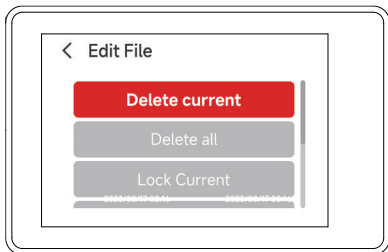

























**Note:**









All of the above functions can be done via the touch screen.

## Function Overview

Short press M button to enter settings menu, where you can adjust various functions.

Icon	Function	Option/Description
	Resolution	Front 4K@30fps+Inside1080P@25fps +Rear 2.5K@30fps
	Audio	ON/OFF
	Recording duration	1/3/5mins
	G-sensor	Off/Low/Medium/High
	Fatigue reminder	A Reminder Will be Made During 1h/2h/3h/4h/OFF
	Wi-Fi	ON/OFF
	Volume	OFF/Low/Medium/High
	Startup Sound	OFF/ON
	Voice control	ON/OFF/Voice Command
	Internal Recording	ON/OFF
	Night Vision Switch	ON/OFF/Auto
	Mirror Flip	Horizontal Flip Your Rear View *Need to connect rear camera

Icon	Function	Option/Description
	Rear Cam Flip	Vertical Flip Your Rear View *Need to connect rear camera
	Parking Monitor	Please connect the ACC hardwire kit
	GPS	Display GPS signal strength
	Date Stamp	ON/OFF
	Speed Stamp	ON/OFF
	GPS Stamp	ON/OFF
	Speed Units	KM/H / MPH
	Language	Choose Your Preferred Language
	Clock Settings	Update With GPS
	Time Style	12h/24h
	Time Zone	Choose Your Time Zone
	DST	Daylight Saving Time ON/OFF

Icon	Function	Option/Description
	Flicker	60Hz/50Hz
	Format Reminder	Reminder to Clear Data
	Format SD Card	Format SD card. All data will be deleted
	Card Speed	Card Speed Detection
	Reset Setup	Reset All Settings
	APP	A QR Code for app
	Product Information	Software Version
	Help Center	Scan the QR code to contact us

## Note:

- In order to a Clean, Smooth, Comfortable using experience, we suggest you format your Memory Card once a month.
- When you turn off Click Tone, the startup and shutdown sounds will also be turned off.

## OTA(Over the air) Update

**Note:** Please update the update the APP to the latest version to use this function.

1. Disconnect the mobile phone and dash cam Wi-Fi.  
Connect the phone to lan for 5 seconds, then disconnect.  
Finally, connect the dash cam Wi-Fi.
2. Once Wi-Fi connection is successful, open the Redtiger APP to start using it. If new software is detected, the APP page will indicate the availability of an update.
3. To upgrade, click on "Upgrade Now". The Redtiger APP will prompt you to download the upgrade package.  
Please note that the actual firmware should prevail over the upgrade package.
4. Connect the dash cam to send the upgrade package.  
Do not power off the dash cam during the upgrade process.  
Once the upgrade is completed, the APP will display the upgrade success message, and the dash cam will automatically restart.

## How to Play Video on Computer

We recommend using REDTIGER Player as the right video Player to watch/play Videos. It can also view Google Maps.

You can Download it for free on Mac or Windows from the following link: <https://www.redtigerscam.com/pages/gps-player>

You can choose different playback modes in Settings>video playback mode. And you can set playback speed, language, map and other functions.



- 1** Video play window (Front)
- 2** Map and track display
- 3** Play control panel
- 4** Speed and driving state indication
- 5** Play list

**Note:**

When you find the desired video file, hold down the left mouse button and drag and drop it onto the video player to play it.

## Installation

### **⚠ WARNING**

Please make sure to connect all cameras and wires before power on the cam screen, otherwise, the camera cannot work properly. Please follow the instructions below for the first-time installation of the redtiger dash cam.

- **Insert Memory Card**

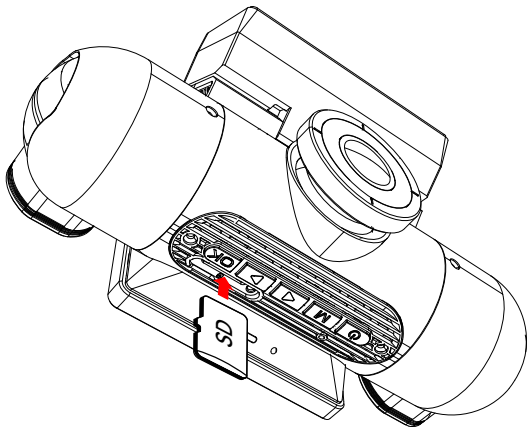

- **Front camera installation**

Peel off the electrostatic sticker on the cellophane and transfer it to where you want to stick it. Attach the front camera to the electrostatic sticker and press to make it firmer.

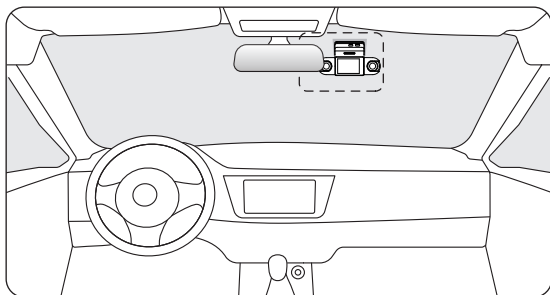
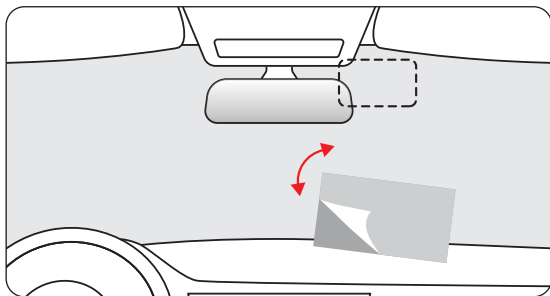

## • Wire Layout In The Vehicle

- 1 The car charger is connected to the cigar socket.
- 2 Connect the other end of the car charger to the dash cam.
- 3 Use the crowbar to run the power cable along the front windshield and the roof, and hide the cable down the A-pillar, so as not to block the driver's sight and cause danger.

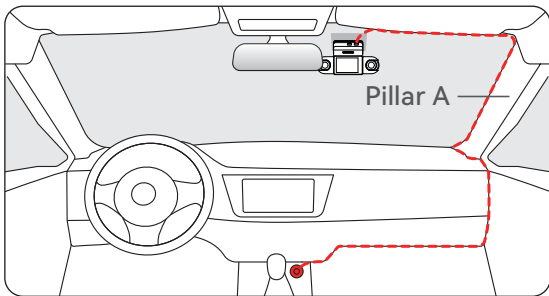

## • Rear camera installation

Peel off the electrostatic sticker on the rear camera and transfer it to where you want to stick it. Attach the camera to the electrostatic sticker and press to make it firmer.

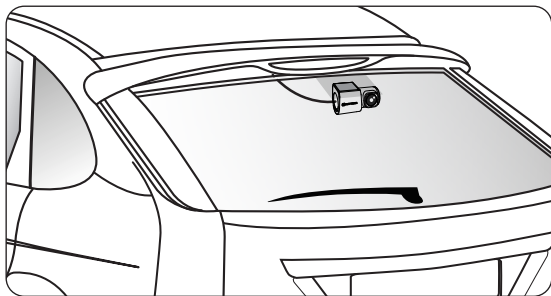
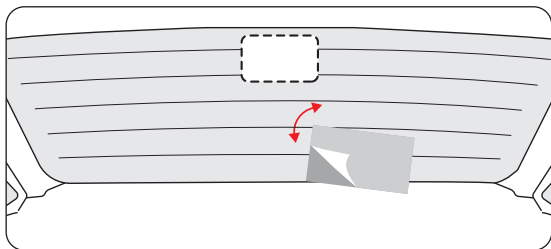



## Trouble Shooting

### • Why is there no GPS signal?

1. Clean and reconnect the probe on the main unit and bracket. Check for any interference in your car, like metal film on the windshield, radio antenna, or radar detector.

2. Move your car to an open area.

3. If the GPS icon is  , it means the GPS signal is good.

If the GPS icon is  , it means there is no GPS signal.

### • Why does my dash cam prompt card error or please format Memory Card every once in a while?

Please follow the steps below to check:

1. Please go to Settings > Format Reminder to check whether the regular format reminder is enabled.

2. Format the Memory Card.

3. Restore factory settings and restart the dash cam.

4. Update the firmware.

### • Dash cam repeated restart/no boot?

1. Make sure you are using the original car charger.

2. Unplug the Memory Card and car charger in turn, and reinstall them. Check whether the short circuit is caused by accessories.

3. Reset the machine through the small hole at the bottom of the driving recorder.

4. If none of the above can solve the problem, please try to power on the USB cable to confirm whether the host can be used normally.

5. Please go to the official website to update the firmware.

6. If it is not resolved, please contact your dedicated customer service for a replacement.

- **Why can't I connect to Wi-Fi?**

1. Check the working distance of Wi-Fi, about 15ft.
2. Check the SSID and password of the Wi-Fi, or whether there are other devices connected to the Wi-Fi.
3. Turn off mobile data, security software, and VPN on your phone.
4. If the issue persists, please contact customer support for assistance.

- **Why is the time setting incorrect?**

The dash cam features built-in GPS. It automatically adjusts time based on your location and time zone, eliminating the need for manual time changes. And you can adjust the time through Settings > Time Zone/DST.

## Customer Service Center

If you have any problems using or installing the dash cam, please contact us with any questions.



Help Center



WhatsApp



### For more information:

After sales: [help@redtigercam.com](mailto:help@redtigercam.com)

Business Cooperation: [contact@redtigercam.com](mailto:contact@redtigercam.com)

Customer Phone Service: +1 888 966 8028 (US)



#### IC warning:

This device contains licence-exempt transmitter(s)/receiver(s) that comply with Innovation Science and Economic Development Canada's licence-exempt RSS(s). Operation is subject to the following two conditions:

1. this device may not cause interference and
2. this device must accept any interference, including interference that may cause undesired operation of the device.

**Radiation Exposure:** This equipment complies with Canada radiation exposure limits set forth for an uncontrolled environment; To maintain compliance with IC's RF Exposure guidelines, This equipment should be installed and operated with minimum distance of 20cm the radiator your body. This device and its antenna(s) must not be co-located or operation in conjunction with any other antenna or transmitter.

#### Déclaration de l'ISED Canada:

Cet appareil contient des tasmittre (s) / récepteur (s) sans licence / conformes à l'innovationRSS exemptes de licence de Sciences et Développement économique Canada.

L'opération est sous réserve des deux conditions suivantes :

3. cet appareil ne peut pas causer d'interférences et
4. ce dispositif doit accepter toute interférence, y compris peut provoquer le fonctionnement indésirable de l'appareil.

**Exposition aux rayonnements :** Cet équipement est conforme aux radiations du Canada limites d'exposition pour un environnement incontrôlé noncé d'exposition RF Pour maintenir le respect des guides d'exposition RF d'IC, cquipment doit être installé et actionné avec une distance minimale de 20cm le radiateur de votre corps. Cet appareil et ses antennes ne doivent pas être colocalisé ou en opération en conjonction avec toute autre antenne ou émetteur.





# REDTIGER

Truly Peace of Mind

Check us out here.  
Product and service are the foundation of Redtiger.

Instagram: @redtiger\_dashcam  
Facebook: Redtiger Dash Cam



[www.redtigercam.com](http://www.redtigercam.com)