

Analog multi timer

**MA4N****INSTRUCTION MANUAL**

Thank you for purchasing HANYOUNG product.  
Please check whether the product is the exactly same as you ordered.  
Before using the product, please read this instruction manual carefully.  
Please keep this manual where you can view at any time

HEAD OFFICE

HANYOUNGNUX CO.,LTD

1381-3, Juan-Dong, Nam-Gu Incheon, Korea.  
TEL:(82-32)876-4697  
FAX:(82-32)876-4696  
http://www.hynux.net

INDONESIA  
FACTORY

PT. HANYOUNG ELECTRONIC INDONESIA

Jl. Cempaka blok F16, No.02 Delta Silicon II  
Cikarang Bekasi Indonesia  
TEL : 62-21-8911-8120~4  
FAX : 62-21-8911-8126

**Safety information**

Before using the product, please read the safety information thoroughly and use it properly.  
Alerts declared in the manual are classified to Danger, Warning and Caution by their criticality

	<b>DANGER</b>	DANGER indicates an imminently hazardous situation which, if not avoided, will result in death or serious injury
	<b>WARNING</b>	WARNING indicates a potentially hazardous situation which, if not avoided, could result in death or serious injury
	<b>CAUTION</b>	CAUTION indicates a potentially hazardous situation which, if not avoided, may result in minor or moderate injury

**DANGER**

There is a danger of occurring electric shock in the input/output terminals so please never let your body or conductive substance is touched.

**WARNING**

- If there is a possibility of an accident caused by errors or malfunctions of this product, install external protection circuit to prevent the accident.
- This product does not contain an electric switch or fuse, so the user needs to install a separate electric switch or fuse externally. (Fuse rating: 250V 0.5A)
- To prevent deflection or malfunction of this product, supply proper power voltage in accordance with the rating.
- To prevent electric shock or malfunction of product, do not supply the power until the wiring is completed.
- Since this product is not designed with explosion-protective structure, do not use it any place with flammable or explosive gas.
- Do not decompose, modify, revise or repair this product. This may be a cause of malfunction, electric shock or fire.
- Reassemble this product while the power is OFF. Otherwise, it may be a cause of malfunction or electric shock.
- If you use the product with methods other than specified by the manufacturer, there may be bodily injuries or property damages.
- Due to the danger of electric shock, use this product installed onto a panel while an electric current is applied.

**CAUTION**

- The contents of this manual may be changed without prior notification.
- Before using the product you purchased, make sure that it is exactly what you ordered.
- Make sure that there is no damage or abnormality of the product during delivery.
- Do not use this product at any place with corrosive (especially noxious gas or ammonia) or flammable gas.
- Do not use this product at any place with direct vibration or impact.
- Do not use this product at any place with liquid, oil, medical substances, dust, salt or iron contents.
- Do not polish this product with substances such as alcohol or benzene.
- Do not use this product at any place with a large inductive difficulty or occurring static electricity or magnetic noise.
- Do not use this product at any place with possible thermal accumulation due to direct sunlight or heat radiation.
- Install this product at place under 2,000 m in altitude.
- When the product gets wet, the inspection is essential because there is a danger of electric leakage or fire.
- If there is excessive noise from the power supply, using insulating transformer or noise filter is recommended. The noise filter must be attached to a panel which is already connected to a ground and the wire between the filter output and power supply terminal must be as short as possible.
- If putting power cables closely together then It is effective against noise.
- Do not connect anything to the unused terminals.
- After checking the polarity of terminal, connect wires at the correct position.
- When this product is connected to a panel, use a circuit breaker or switch approved with IEC60947-1 or IEC60947-3.
- Install the circuit breaker or switch at near place for convenient use.
- Write down on a label that if the circuit breaker or switch is operating then the power will be disconnected since the circuit breaker or switch is installed.
- For the continuous and safe use of this product, the periodical maintenance is recommended.
- Some parts of this product have limited life span, and others are changed by their
- The warranty period for this product including parts is one year if this product is properly used.

**Suffix code**

Model	Code	Description
MA4N -	<input type="checkbox"/>	Analog multi timer (48 x 48 mm)
Device selection	A	2c (Time limit) * 11 pin type
	B	2c (Time limit + Constantaneous) * 11 pin type
	C	2c (Time limit), 2c (Time limit + Constantaneous) * Processed by mode selection (8pin type)
Power supply voltag		24 - 240 V a.c / d.c (50 - 60 Hz) Dual usage

**Specification**

Model	MA4N-A	MA4N-B	MA4N-C
Power Supply voltage	24 - 240 V a.c / d.c 50 - 60 Hz		
Voltage regulation	±10 % from supply voltage		
Power consumption	5.3 VA (240 V a.c), 2.5 W (240 V d.c)		
Resetting time	0.1 sec max		
Min Signal length	START Input	20 ms min	-
	INHIBIT Input		
	RESET Input		
Input condition	START Input	Non voltage Input Impedance in a short circuit : 2 kΩ max Residual voltage in a short circuit : 0.7 V d.c max Impedance in open : 100 kΩ min	-
	INHIBIT Input		
	RESET Input		
Output	Time limit 2c	Time limit 1c Instautaneous 1c	Time limit 2c Time limit 1c Instautaneous 1c
	N.O : 10 A 125 V a.c, 5 A 250 V a.c, 5 A 30 V d.c N.C : 3 A 125 V a.c, 2 A 250 V a.c, 1 A 30 V d.c		
Setting error	± 5 % ±0.05 sec max		
Repeat error	± 0.3 % max		
Temperature error	± 2 % max		
Insulation resistance	100 MΩ min (Base on 500 V d.c)		
Dielectric strength	2000 V a.c 50 / 60 Hz for 1 min		
Impulse voltage	±2000 V max		
Vibration	Mechanical durability	10 - 55 Hz double amplitude 0.75 mm	
	Malfunction durability	10 - 55 Hz double amplitude 0.5 mm	
Shock	Mechanical durability	300 % (Approx. 30 G)	
	Malfunction durability	100 % (Approx. 10 G)	
Life expectancy	Mechanical	Over 10 million operations (Open & Short frequency : 180 / min)	
	Electrical	Over 100,000 (250 V a.c 3 A load resistance)	
Terminal type	Socket type 11 Pin		Socket type 8 Pin
Ambient temperature	-10 ~ 55 °C (With no condensation)		
Conservation temperature	-20 ~ 65 °C (With no condensation)		
Ambient humidity	35 ~ 85 %R.H.		
Weight	About 100g (Including fixing bracket)		

## Time range

Max time	Time unit			
	sec	min	hrs	x10h
Setting range	1.2	0.12 ~ 1.2		1.2 ~ 12
	3	0.3 ~ 3		3 ~ 30
	12	1.2 ~ 12		12 ~ 120
	30	3 ~ 30		30 ~ 300

## Part name

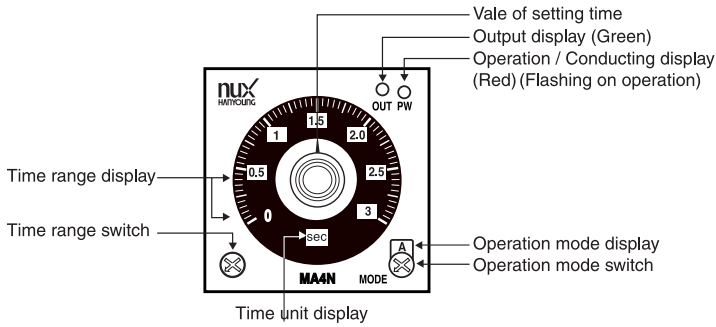

## Dimension and panel cutout

[unit : mm]

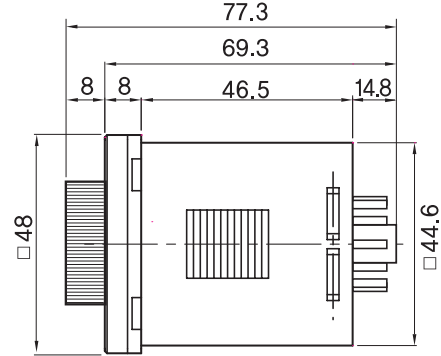
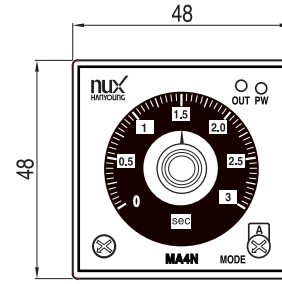

## External connection

Please select operation mode by turning of operation mode switch in front of panel.

User can select 6 types of operation modes Operation mode is displayed as like

A, B, C, D, E, F or A1, B1, C1, D1, E1, F1.

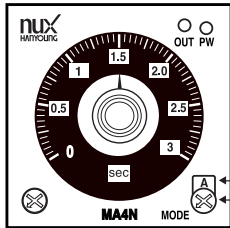

MA4N -A, MA4N - B TYPE

MODE	Function of operation
A	ON DELAY
B	FLICKER OFF START
C	INTERVAL
D	SIGNAL ON/OFF DELAY
E	SIGNAL OFF DELAY
F	FLICKER ON START

MA4N - C TYPE

MODE	Function of operation
A1	ON DELAY
B1	ON DELAY1
C1	ON DELAY2
D1	FLICKER OFF START
E1	FLICKER ON START
F1	INTERVAL

## Selection of time unit

Please select time by turning of Time range switch

User can select 16 types of time ranges and it is displayed as like sec, min, hrs, 10h

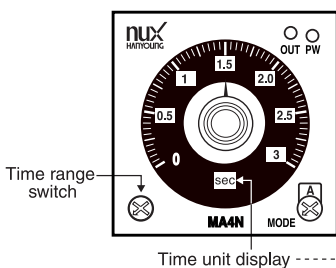

Time unit	Time range
sec, min, hrs, 10h	0, 0.2, 0.4, 0.6, 0.8, 1.0, 1.2
	0, 0.5, 1, 1.5, 2, 2.5, 3
	0, 2, 4, 6, 8, 10, 12
	0, 5, 10, 15, 20, 25, 30

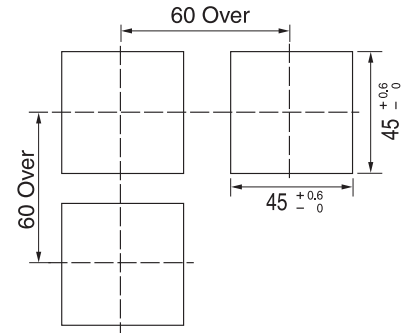

## Connection diagram

### MA4N-A / MA4N-B

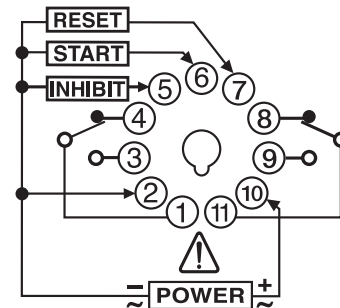

- MA4N-A : 2 relay work as Time limit.
- MA4N-B : The relay connected ①, ③, ④ work as Instantaneous and othr ealys work as time limit.
- \*Please refer to Timing charts for working of relays

### Selection of time unit

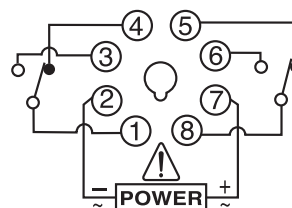

- Two relays in Mode A1 and D1 work as Time limit.
- The relays in Mode B1, C1, E1, F1 connected ①, ③, ④ work as Instantaneous.
- And other relays work as time limit.
- \*MA4N-C : According to timing charts, relays works as Time limit or Instantaneous.
- \*Please refer to Timing charts for working of relays.

# Timing charts (MA4N-A, MA4N-B)

※ MA4N-A : Output – Time limit 2c MA4N-B : Output – Instantaneous 1c, Time limit 1c

## A MODE: ON DELAY

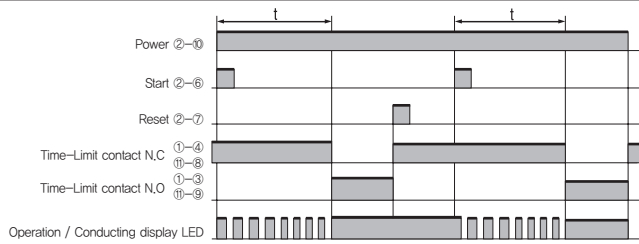

## B MODE: FLICKER OFF START

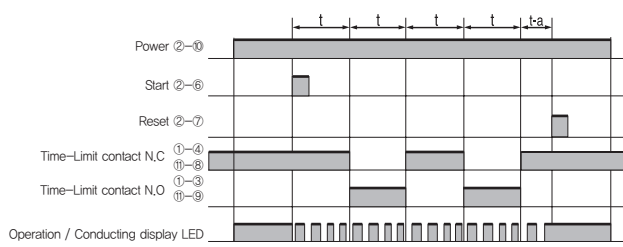

## C MODE: INTERVAL

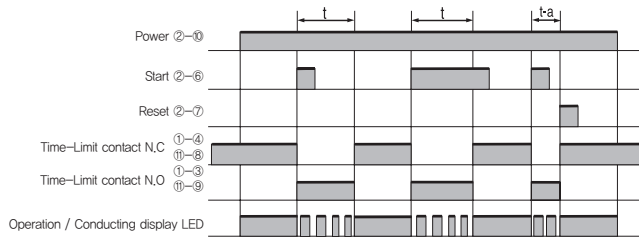

## D MODE: SIGNAL ON / OFF DELAY

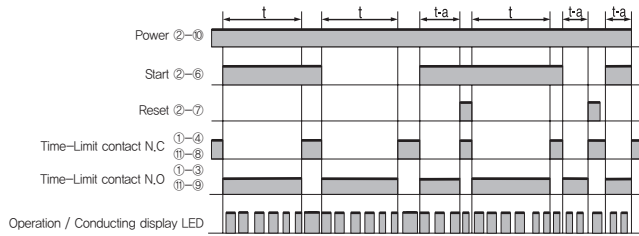

## E MODE: SIGNAL OFF DELAY

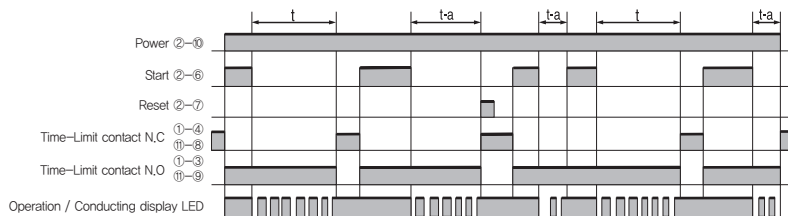

## F MODE: FLICKER ON START

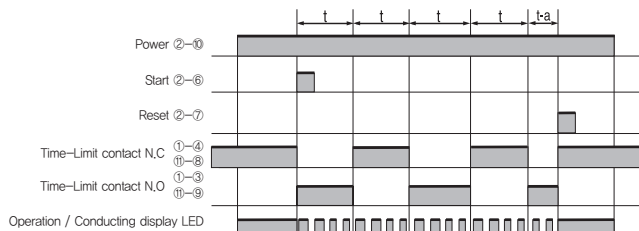

# Timing charts (MA4N-C)

\* t : Setting time, t-a: Within setting time, Rt: Resetting time

## A1 MODE : ON DELAY

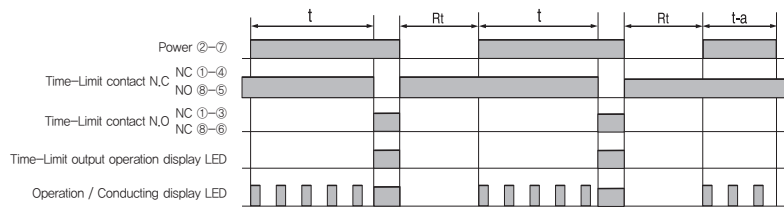

## B1 MODE : ON DELAY 1 (One-shot output)

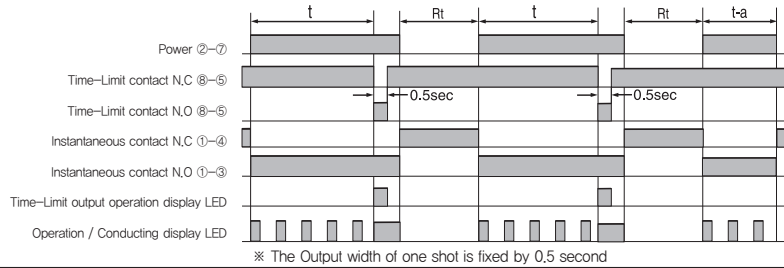

## C1 MODE : ON DELAY2

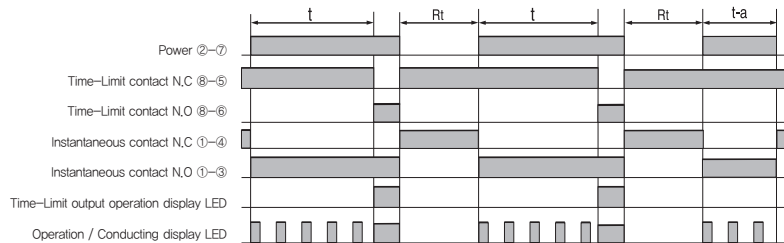

## D1 MODE : FLICKER OFF START

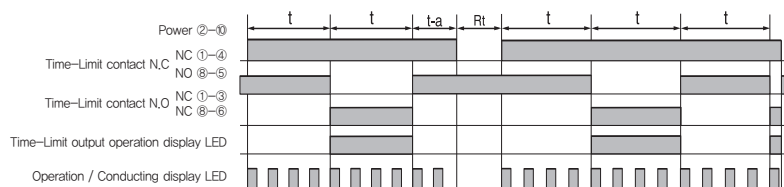

## E1 MODE : FLICKER ON START

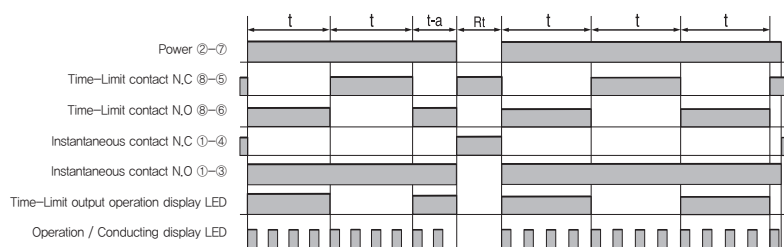

## F1 MODE : INTERVAL

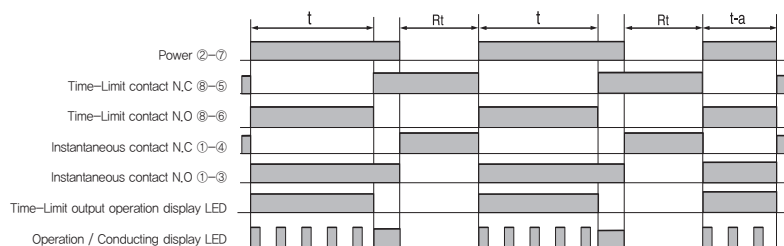

※ We suggest over 100 ms of Min. setting time for D1, E1 output mode because excessive short setting time may cause of malfunction.