



# START GREEN ENERGY WITH

Shenzhen Topway  
New Energy Co.,Ltd

# CORPORATE BROCHURE

Shenzhen Topway New Energy focus on new energy battery research and development, production and sales as one of the high-tech enterprises.

Add: Building A, Xinlida Industrial Park, Junzibu Village, Guanlan Street, Longhua District, Shenzhen, Guangdong  
TEL :0755-23225527 FAX:0755-23225537

Safe  
Energy  
Quality  
Life



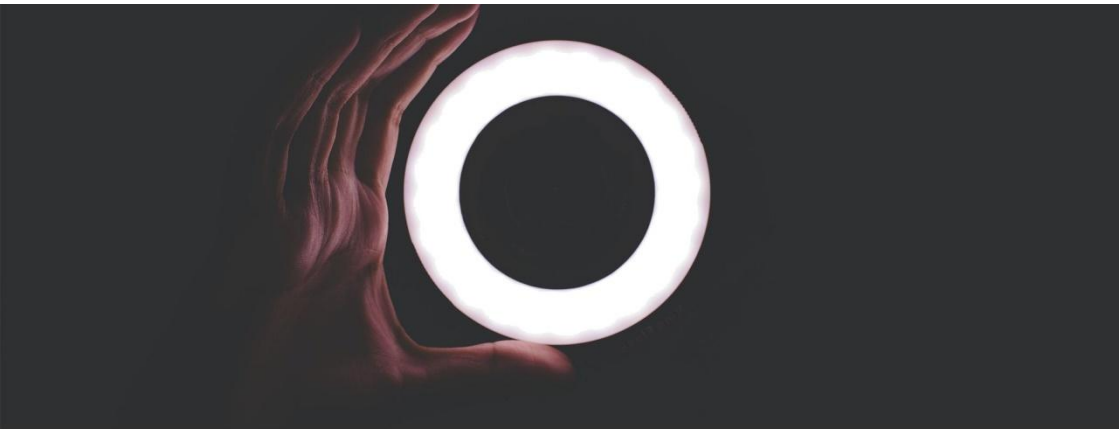

# COMPANY PROFILE

Shenzhen Topway New Energy Co., Ltd was founded in 2013. We focus on manufacturing and design of lithium battery packs for Green Energy Storage Systems. We also provide the full services of customized battery products, including battery design, development, selection cells and BMS, Charger and after-sale service. The main products include OEM&ODM 12V/24V/36V/48V LiFePO4 Battery Pack, Wall-mounted ESS All-in-one Mobile ESS, Mobile ESS, Stack'd ESS, inverter, Photovoltaic solar panel, Transformers and solar street light controller. These products are widely used in the fields of home storage energy, RV energy, UPS, Tower Base Station, solar energy storage systems etc.

Since the establishment of the company, the products have been exported to more than 100 countries and regions around the world contributing greatly to the global supply of green energy, and have been well received by users all over the world. We have overseas warehouses in Germany, Poland, and the United States. We will provide you with grade A battery quality, fast delivery service, and stable DDP transportation channel. Feel free to contact us any time!



## Inverter Control All-in-one Machine



### 1. Long life and safety

Vertical industry integration ensures more than 6000 cycles with 80% DOD.

### 2. Easy to install and use

Integrated inverter design, easy to use and quick to install. Small size, minimizing installation time and cost compact and stylish design suitable for your sweet home environment.

### 3. Multiple working modes

The inverter has a variety of working modes whether it is used for main power supply in the area without electricity or backup power supply in the area with unstable power to deal with sudden power failure, the system can respond flexibly.

### 4. Fast and flexible charging

A variety of charging methods, which can be charged with photovoltaic or commercial power, or both at the same time.

### 5. Scalability

Supports 2 output modes of 220V or 380V to meet different needs of users, it also support maximum 6 units in parallel connection

### 6. APP function

Support PACE EX App control

TW-AO-MB51300-AC380V-12KW-EU

TW-AO-MB51400-AC380V-12KW-EU

TW-AO-MB51600-AC380V-12KW-EU

---

# Contents

<b>1. Instruction .....</b>	<b>7</b>
1.1 How to use this manual .....	7
1.2 Symbols in this manual .....	7
1.3 Safety instructions .....	7
<b>2. Production Instructions .....</b>	<b>8</b>
2.1 Instructions .....	8
2.2 Features .....	8
2.3 System connection diagram .....	9
2.4 Production Overview .....	9
<b>3. Inspections before Installation .....</b>	<b>10</b>
3.1 Inspection of outer package .....	10
3.2 Inspection of deliverable .....	10
<b>4. Installation .....</b>	<b>11</b>
4.1 Select the mount location .....	11
<b>5. Connection .....</b>	<b>11</b>
5.1 Three-phase output .....	11
5.2 Cable & circuit breaker requirement .....	13
5.3 AC input & output connection .....	13
5.4 PV connection .....	14
5.5 Dry contact connection .....	14
5.6 Grounding connection .....	15
5.7 Active Equilibrium Function (Optional) .....	15
5.8 Fire extinguishing function (Optional) .....	16
5.9 Final assembly .....	16
5.10 Start up the inverter .....	16
5.11 Parallel wiring .....	16

---





<b>6. Operation .....</b>	<b>19</b>
6.1 Operation and display panel .....	19
6.2 AC output mode .....	31
6.3 Battery charging mode .....	32
6.4 Time-slot charging/discharging function .....	33
6.5 Battery parameter .....	34
<b>7. Communication .....</b>	<b>36</b>
7.1 Overview .....	36
7.2 Inverter Communication Interface .....	37
7.3 Battery Communication Interface .....	39
<b>8. Fault and Remedy .....</b>	<b>45</b>
8.1 Fault code .....	45
8.2 Troubleshooting .....	46
<b>9. Protection and Maintenance .....</b>	<b>47</b>
9.1 Protection features .....	47
9.2 Maintenance .....	48
<b>10. Datasheet .....</b>	<b>49</b>

# 1. Instruction

## 1.1 How to use this manual

- This manual contains important information, guidelines, operation and maintenance for the following products: AO-MB51600-AC380V-12KW-EU, AO-MB51400-AC380V-12KW-EU, AO-MB51300-AC380V-12KW-EU
- The manual must be followed during installation and maintenance.

## 1.2 Symbols in this manual

Symbol	Description
 <b>DANGER</b>	DANGER indicates a hazardous situations which if not avoided will result in death or serious injury.
 <b>WARNING</b>	WARNING indicates a hazardous situations which if not avoided could result in death or serious injury.
 <b>CAUTION</b>	CAUTION indicates a hazardous situations which if not avoided could result in minor or moderate injury.
 <b>NOTICE</b>	NOTICE provide some tips on operation of products.

## 1.3 Safety instructions

### **DANGER**

- This chapter contains important safety instructions. Read and keep this manual for future reference.
- Be sure to comply the local requirements and regulation to install this inverter.
- Beware of high voltage. Please turn off the switch of each power sources before and during the installation to avoid electric shock.
- For optimum operation of this product, please follow required specification to select appropriate cable size and necessary protective device.
- Do not connect or disconnect any connections when the inverter is working.
- Do not open the terminal cover when the inverter working.
- Make sure the inverter is well grounding.
- Never cause AC output and DC input short circuited.
- Do not disassembly this unit, for all repair and maintenance, please take it to the professional service center.
- Never charge a frozen battery.
- Please keep children away from touching or mishandling the inverter.
- Please make sure that this inverter is the only input power source for the load, do not use it in parallel with other input AC power sources to avoid damage.

## 2. Production Instructions

### 2.1 Instructions

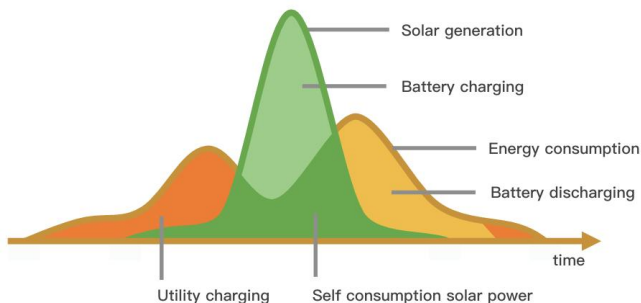

### 2.2 Features

- Supports lead-acid battery and li-ion battery connections.
- With a dual activation function when the li-ion battery is dormant; either mains or photovoltaic power supply access can trigger the activation of the li-ion battery.
- Support three-phase pure sine wave output (350~415V).
- Supports phase voltage adjustment in the range of 200, 208, 220, 230, 240Vac.
- Supports two PV inputs, with the function of simultaneously tracking the maximum power charging or carrying capacity of two MPPT.
- Dual MPPT, efficiency up to 99.9%, single maximum current of 22A, perfectly adapted to high-power modules.
- 4 charging modes are available: solar only, mains priority, solar priority, and mixed mains and PV charging.
- With time-slot charging and discharging setting function, it helps users to take advantage of peak and valley tariffs and save electricity costs.
- Energy-saving mode function to reduce no-load energy losses.
- With two output modes of utility bypass and inverter output, with uninterrupted power supply function.
- LCD large screen dynamic flow diagram design, easy to understand the system data and operation status.
- 360° protection with complete short-circuit protection, over-current protection, over-voltage protection, under-voltage protection, over-load protection, etc.
- Support CAN, USB, and RS485 communication.

## 2.3 System connection diagram

The diagram below shows the system application scenario of this product. A complete system consists of the following components:

1. PV modules: converts light energy into DC energy, which can be used to charge the battery via an inverter or directly inverted into AC power to supply the load.
2. Utility grid or generator: connected to the AC input, it can supply the load and charge the battery at the same time. The system can also operate generally without the mains or generator when the battery and the PV module power the load.
3. Battery: The role of the battery is to ensure the regular power supply of the system load when the solar energy is insufficient and there is no mains power.
4. Home load: Various household and office loads can be connected, including refrigerators, lamps, televisions, fans, air conditioners, and other AC loads.
5. Inverter: The energy conversion device of the whole system.

The actual application scenario determines the specific system wiring method.

## 2.4 Production Overview

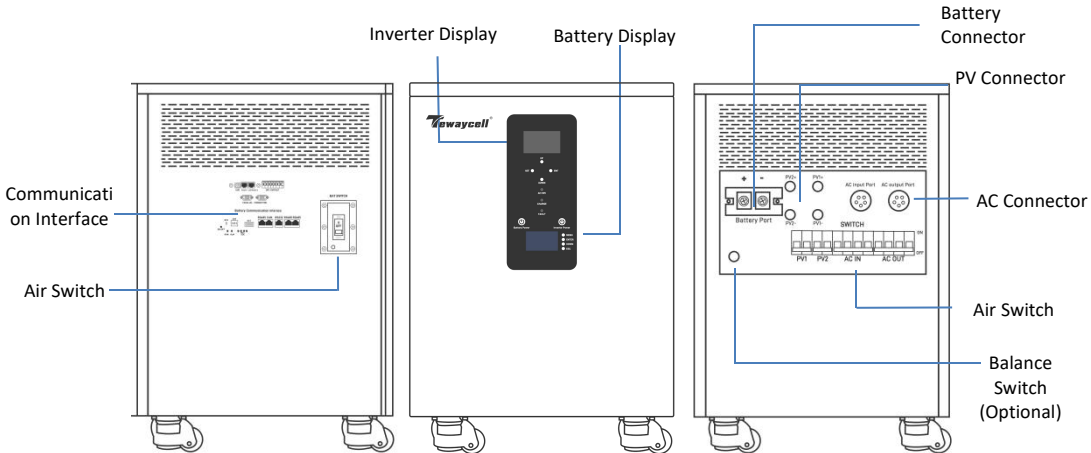





## 3. Inspections before Installation

### 3.1 Inspection of outer package

Before opening outer package of the all-in-one machine, check if there is any visible damage on the outer package, such as holes, cracks or other signs of possible internal damage, and check the type of all-in-one machine. If there is any abnormality on the package or model of the all-in-one machine is inconsistent, do not open it and contact us as soon as possible.

### 3.2 Inspection of deliverable

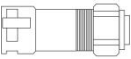
After opening outer package of the all-in-one machine, check if the deliverable is complete and whether there is any visible external damage. If any items are missing or damaged, please contact us.

No.	Picture	Item	Quantity	Specification
1		All-in-one machine	1	
2		Parallel communication cable	1	
3		Wiring ring	2	SC70-10/cold-pressed terminal head thickened wire terminal
4		AC plug	2	Connect AC power
5		Photovoltaic connectors	2	Solar panel connecting wire terminal
6		Disassembly and assembly tools for solar panel connectors	1	
7		Product Manual	1	

## 4. Installation

### 4.1 Select the mount location

12KW output three-phase integrated machine series are designed for INDOOR USE ONLY (IP20). Please consider the followings before selecting the location.

- Adequate heat dissipation space must be provided for the product.
- The ambient temperature should be between  $-10^{\circ}\text{C}$   $\sim$   $55^{\circ}\text{C}$  ( $14^{\circ}\text{F}$   $\sim$   $131^{\circ}\text{F}$ ) to ensure optimal operation.

#### **⚠ DANGER**

- Do not install the inverter where highly flammable materials are near by.
- Do not install the inverter in potential explosive areas.
- Do not install the inverter with lead-acid batteries in a confined space.

#### **⚠ CAUTION**

- Do not install the inverter in direct sunlight.
- Do not install or use the inverter in a humid environment.

## 5. Connection

### 5.1 Three-phase output

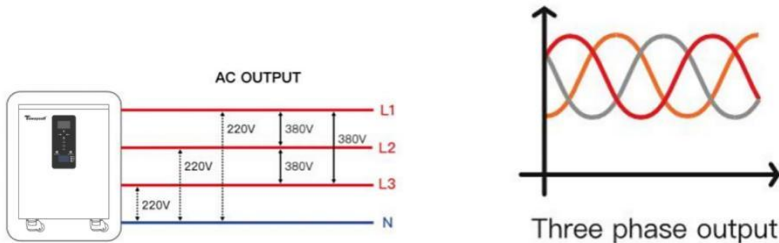

Items	Description		
Applicable Model	AO-MB51600-380VAC-12KW	AO-MB51400-380VAC-12KW	AO-MB51300-380VAC-12KW
Output Voltage Range (L-N)	200~240Vac, 230Vac deaf		

#### **Notice:**

Users can change the output phase mode and output voltage by setup menu. Please read the chapter 6.1.2 Setting.

The output voltage corresponds to item [38] of the parameter setting, and the output phase voltage can be set within the range of 200V to 240V.

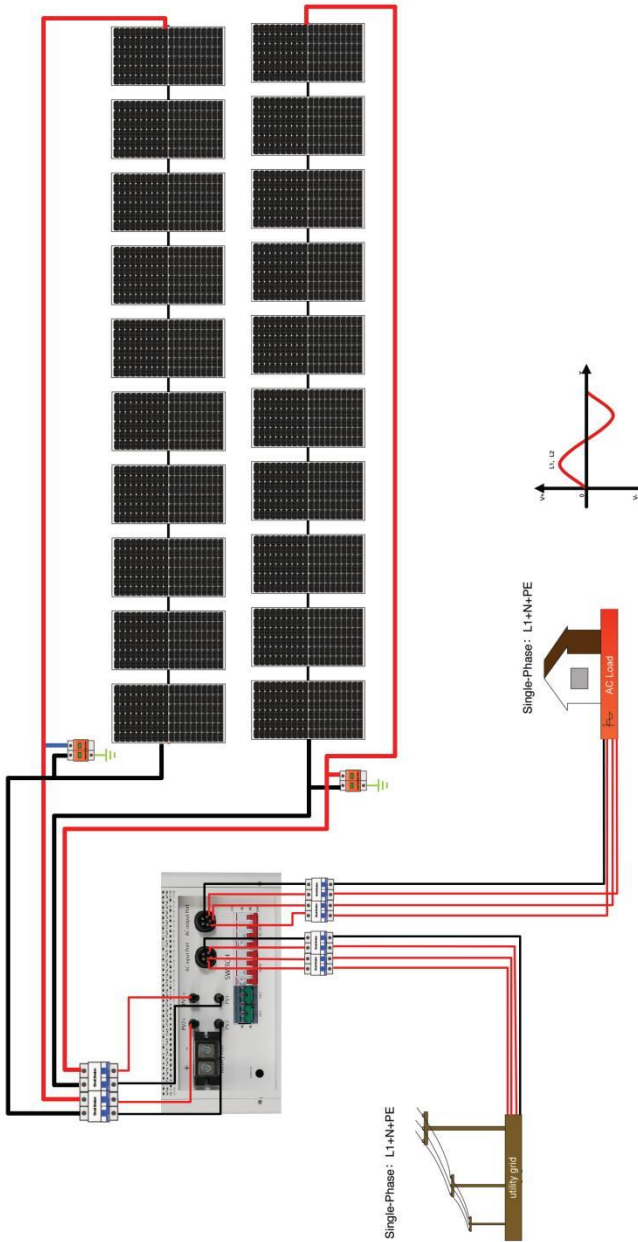

Add: Building A, Xinlida Industrial Park, Junzibu Village, Guanlan Street, Longhua District ,Shenzhen, Guangdong

TEL :0755-23225527 FAX:0755-23225537

## 5.2 Cable & circuit breaker requirement

- PV INPUT**

Models	Cable Diameter	Max. PV Input Current	Circuit Breaker Spec
SPI-12K-H3P	5mm <sup>2</sup> /10AWG	22A	2P-25A

- AC INPUT**

Models	Output mode	Max. Input Current	Cable diameter	Circuit Breaker Spec
SPI-12K-H3P	Three-phase	35A	9mm <sup>2</sup> /6AWG(L1/L2/L3/N)	4P-40A

- AC OUTPUT**

Models	Output mode	Max. Input Current	Cable diameter	Circuit Breaker
SPI-12K-H3P	Three-phase	17.4A	8mm <sup>2</sup> /6AWG(L1/L2/L3/N)	4P-40A

**NOTICE**

- AC INPUT、AC OUTPUT**

Connect the marked L1 L2 L3 N PE according to the recommended wire diameter in 5.2, and then plug the 5-hole AC plug into the AC socket on the all-in-one machine

- PV INPUT、PV OUTPUT**

Connect the appropriate wire according to the recommended wire diameter in 5.2

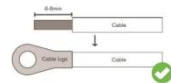
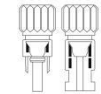
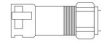

The wire diameter is for reference only. If the distance between the PV array and the inverter or between the inverter and the battery is long, using a thicker wire will reduce the voltage drop and improve the performance of the system.

## 5.3 AC input & output connection

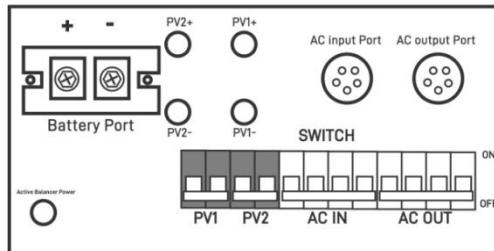

Connect the live, neutral and ground wires according to the cables' position and order shown in the diagram below.

**⚠ DANGER**

- Before connecting AC inputs and outputs, the circuit breaker must be opened to avoid the risk of electric shock and must not be operated with electricity.
- Please check that the cable used is sufficient for the requirements, too thin, poor quality cables are a serious safety hazard.

Add: Building A, Xinlida Industrial Park, Junzibu Village, Guanlan Street, Longhua District ,Shenzhen, Guangdong

TEL :0755-23225527 FAX:0755-23225537

## 5.4 PV connection

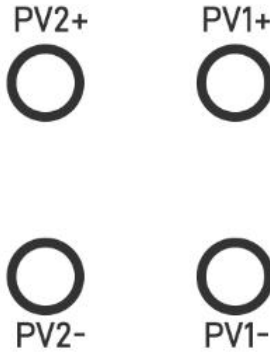

Connect the positive and negative wires of the two strings of PV according to the diagram below.

### **⚠ DANGER**

- Before connecting PV, the circuit breaker must be opened to avoid the risk of electric shock and must not be operated with electricity.
- Please make sure that the open circuit voltage of the PV modules in series does not exceed the Max. Open Circuit Voltage of the product (this value is 800V), otherwise the inverter maybe damaged.

## 5.5 Dry contact connection

Use a small screwdriver to push back the direction indicated by the arrow, then insert the communication cable into the dry junction port. (Communication cable diameter 0.2~1.5mm<sup>2</sup>)

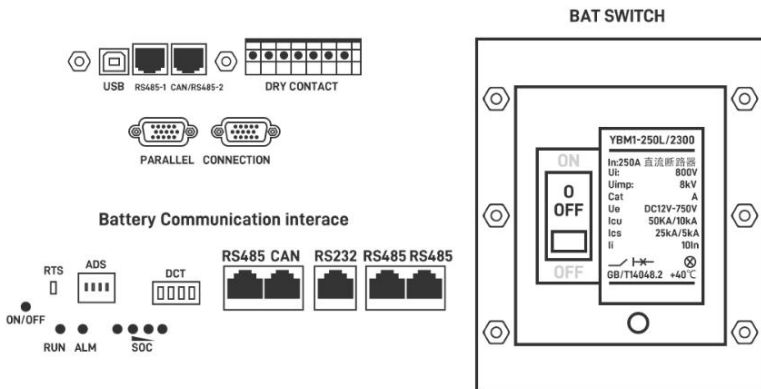

Add: Building A, Xinlida Industrial Park, Junzibu Village, Guanlan Street, Longhua District, Shenzhen, Guangdong

TEL :0755-23225527 FAX:0755-23225537

## 5.6 Grounding connection

Please make sure the grounding terminal connect to the Grounding Bar.

AC input Port      AC output Port



### NOTICE

- The grounding cable should have a diameter of not less than 4 mm<sup>2</sup> and be as close as possible to the grounding point.

## 5.7 Active Equilibrium Function (Optional)

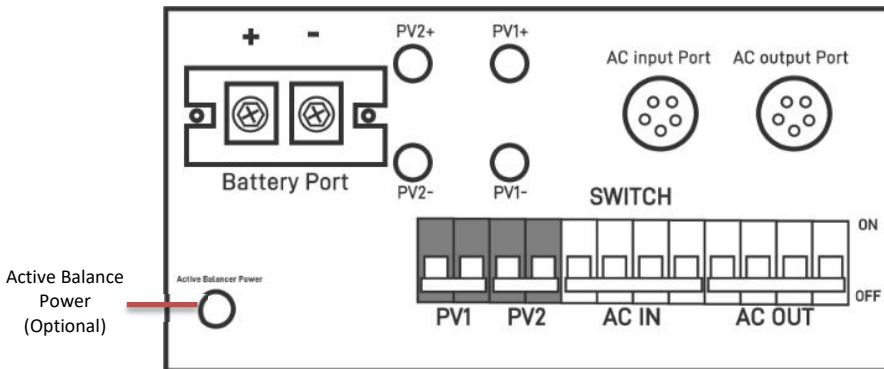

Test Item	Min	Type	Max
Single IC working voltage (Single series)	1.8V		4.5V
Balance opening voltage difference on		/	
Balance closing voltage difference on			
Accuracy of the balance voltage difference		5mV ≅	
Balanced turn-on voltage (first string voltage)		2.90V ≅	
Balanced turn off voltage (first string voltage)		2.50V ≅	
Balanced current (large voltage difference and large current)	0	/	6A
Balanced operating voltage range (B0 to B+ voltage)	46.4V		68.0V
current consumption when working	100uA		1000uA
current consumption when sleeping	0		8.0uA
Working temperature		-40~+85℃	

Add: Building A, Xinlida Industrial Park, Junzibu Village, Guanlan Street, Longhua District, Shenzhen, Guangdong

TEL :0755-23225527 FAX:0755-23225537

## 5.8 Fire extinguishing function (Optional)

The battery is equipped with an aerosol fire extinguishing device. When the battery experiences a short circuit and catches fire, the fire extinguishing device can detect the temperature and automatically extinguish the fire.



Item	Parameter
Model specifications	QRR0.04G/S-MC-40-F-02-11
Working temperature range	-30℃~+70℃
Relative humidity of working environment	≤95%RH
Start mode	Hot start
Spray time	≤3s
Starting temperature of thermal initiator	170±10℃

## 5.9 Final assembly

After ensuring that the wiring is reliable and the wire sequence is correct, install the terminal protection cover in place.

### 5.10 Start up the inverter

- Step 1: Press the switch on the bottom of inverter , close the circuit breaker of the battery.
- Step 2: Press the switch on the bottom of inverter, the screen and indicators light up to indicate that the inverter has been activated.
- Step 3: Sequential close of the circuit breakers for PV, AC input and AC output.
- Step 4: Start the loads one by one in order of power from small to large.

## 5.11 Parallel wiring

### 5.11.1 Parallel operation

1. The parallel operation supports up to six solar storage inverters.
2. When using the parallel function, it is necessary to connect the parallel communication cable in a correct and reliable manner. See the figure blow for the communication cable (packaging accessory):

**Parallel communication cable\*1**

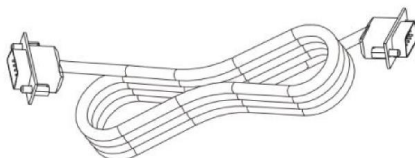

---

## 5.11.2 Cautions for parallel connection



### Warning:

#### 1. PV wiring:

In parallel connection, the PV array of each inverter must be independent, and the PV array of PV1 and PV2 for one inverter must also be independent.

#### 2. AC OUT wiring:

In single-phase parallel connection, all solar storage inverters must be connected in the manner of L-to-L, N-to-N, and PE-to-PE, and before power on and start-up, it is necessary to check and ensure correct connection, wiring length, and cable size, so as to avoid the abnormal operation of parallel system output caused by wrong connection.

In three-phase parallel connection, all solar storage inverters must be connected in the manner of N-to-N and PE-to-PE. The L lines of all inverters in the same phase shall be connected together, but the AC output L lines of different phases shall not be connected together. Other cautions are the same as those for single-phase parallel connection.

#### 3. AC IN wiring:

In single-phase parallel connection, all solar storage inverters must be connected in the manner of L-to-L, N-to-N, and PE-to-PE, and before power on and start-up, it is necessary to check and ensure correct connection, wiring length, and cable size, so as to avoid the abnormal operation of parallel system output caused by wrong connection. Meanwhile, it is not allowed to have multiple different AC source inputs to avoid damage to the external equipment of the inverter. The AC source input shall be consistent and unique.

In three-phase parallel connection, all solar storage inverters must be connected in the manner of N-to-N and PE-to-PE. The L lines of all inverters in the same phase shall be connected together, but the AC output L lines of different phases shall not be connected together. Other cautions are the same as those for single-phase parallel connection.

#### 4. Communication wiring:

Our company's communication cable for parallel operation is a DB15 standard computer cable with shielding function, and it is used for single-phase or three-phase parallel connection. Each inverter shall be connected with one out and one in, that is, the male connector (out) of the inverter is to be connected to the female connector (in) of the parallel inverter, not the one of the inverter. In addition, DB15 terminal screws will be used to tighten the communication cable of each parallel inverter to avoid falling off or poor contact of the communication cable, followed by abnormal operation or damage of the system output.

5. Before and after connecting the system, please carefully refer to the following system wiring diagrams to ensure that all wiring is correct and reliable before power on.

6. After the system is correctly wired, powered on, and in normal operation, if a new inverter needs to be connected, make sure to disconnect the battery input, PV input, AC input and AC output, and that all solar storage inverters are powered off before reconnecting into the system.

### 5.1.1.3 Schematic diagram of parallel connection

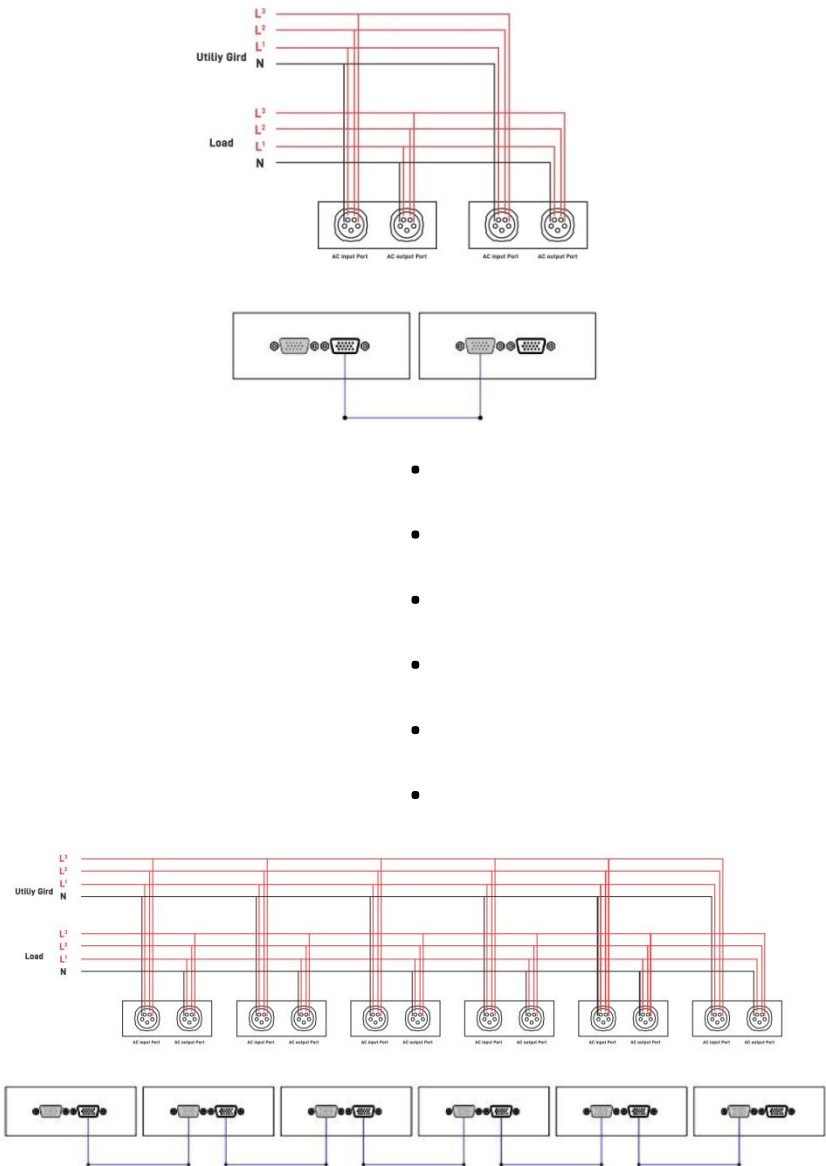

Add: Building A, Xinlida Industrial Park, Junzibu Village, Guanlan Street, Longhua District, Shenzhen, Guangdong

TEL :0755-23225527 FAX:0755-23225537

## 6. Operation

### 6.1 Operation and display panel

#### 6.1.1 Battery display

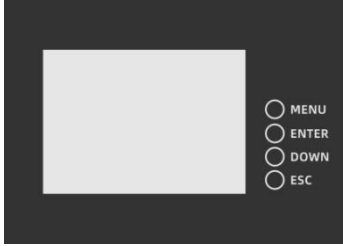

Button Description:

**MENU**: enter the management system.

**ENTER**: enter the submenu.

**DOWN**: moves the cursor down or to the next page.

**ESC**: returns to the previous one

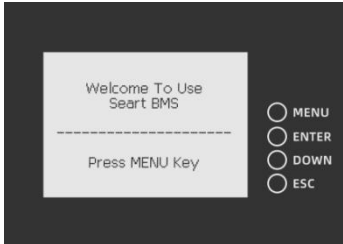

Battery protection status:

Overvoltage: OV

Low voltage: LV

Overtemperature: OTt

Low temperature: IT

Over current: OC

Short circuit: SC

Note: when the battery is protected, the corresponding protection status will be displayed; otherwise, the protection status will not be

Press "MENU" to enter the main menu

Note: "»" indicates that there is a submenu. Press "enter" to enter the submenu

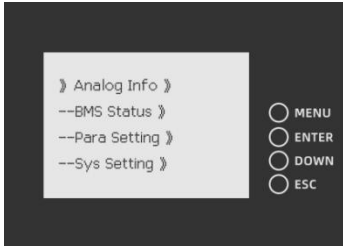

Analog Info	»
BMS Status	»
Para Setting	»
Sys Setting	»

Move the cursor to Analog info and press enter

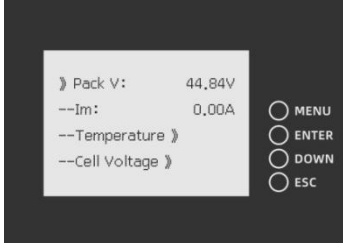

Pack V	
Im	
Temperature	»
Cell Voltage	»
CellCapacity	»

Add: Building A, Xinlida Industrial Park, Junzibu Village, Guanlan Street, Longhua District, Shenzhen, Guangdong

TEL :0755-23225527 FAX:0755-23225537

Move the cursor to "temperature" and press "enter" to check the battery temperature information, then press "down" to turn the page

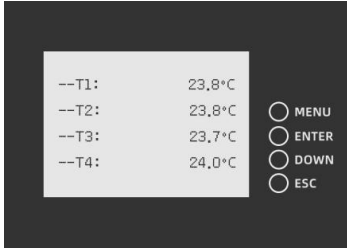

T1	XX°C
T2	XX°C
T3	XX°C
T4	XX°C
PCB-T	XX°C
ENV-T	XX°C

Move the cursor to "cell voltage" and press "enter" to check the battery voltage information, then press "down" to turn the page

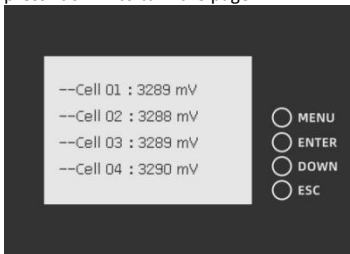

Cell 01	xxxxmV
Cell 02	xxxxmV
Cell 03	xxxxmV
Cell 04	xxxxmV

Move the cursor to "CellCapacity" and press Enter to check the battery capacity information

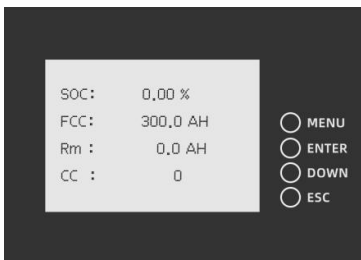
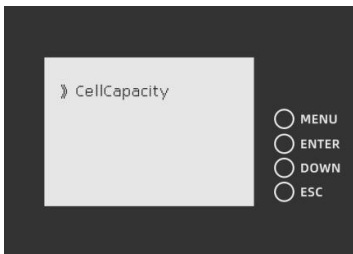

SOC	X%
FCC	XAH
Rm	XAH
CC	0

Move the cursor to "BMS Status", press Enter to check the battery status, and press "▼" to turn the page

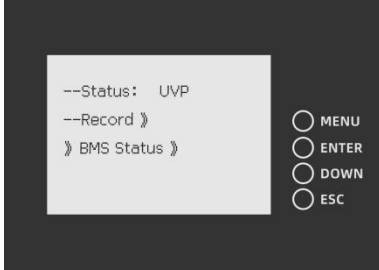

Status	
Record	>>
BMS Status	>>

Move the cursor to "Record", then press "Enter" to check the battery alarm information, then press "DOWN" to turn the page.

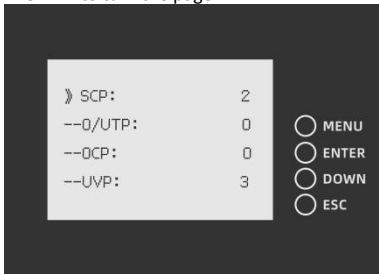

SCP	
O/UTP	
OCP	
UVP	
OVP	

Move the cursor to "BMS Status", then press "Enter" to check the battery protection information, and then press "DOWN" to turn the page.

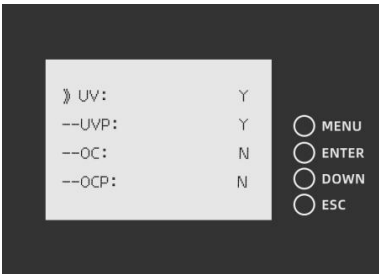

UV	Y/N
UVP	Y/N
OC	Y/N
OCP	Y/N
OT	Y/N
OTP	Y/N
OV	Y/N
OVP	Y/N
SCP	Y/N
Failure	Y/N

The user selects the correct communication protocol version by pressing the button and sends the selected protocol version number back to the BMS motherboard program, thereby changing the default communication protocol between BMS and the upper computer. The selection menu for this function is located in the system settings menu directory.

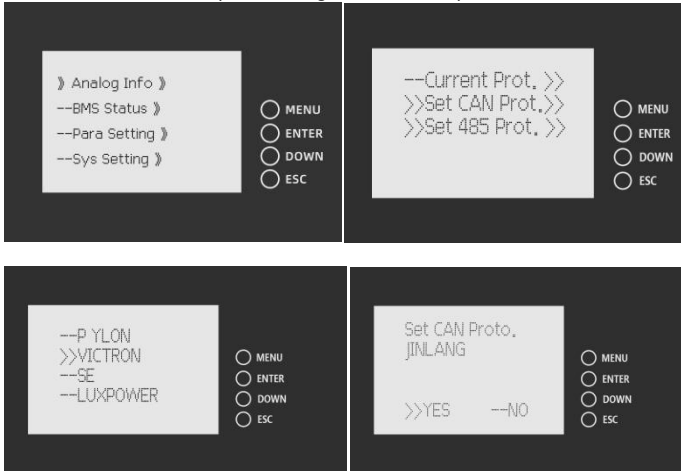

Move the cursor to "Sys Setting", then press Enter to check the version information, and then press "▼" to turn the page.

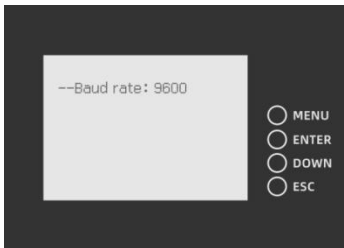

## 6.1.2 Inverter display

- The INVERTER DISPLAY

The operation and display panel is as shown below, including 1 LCD screen, 3 indicators and 4 operation buttons.

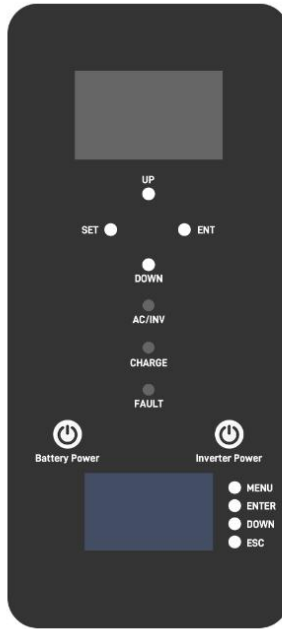

- **Operation buttons introduction**

Function buttons	Description
SET	To enter/exit the setting menu
UP	To next selection
DOWN	To last selection
ENT	To confirm/enter the selection in setting menu

- **LED Indicators**

Indicators	Colors	Description
AC/INV	Green	Continued: utility grid by-pass output
		Flash: inverter output
CHARGE	Yellow	Continued: charging complete
		Flash: charging
FAULT	Red	Flash: error occur



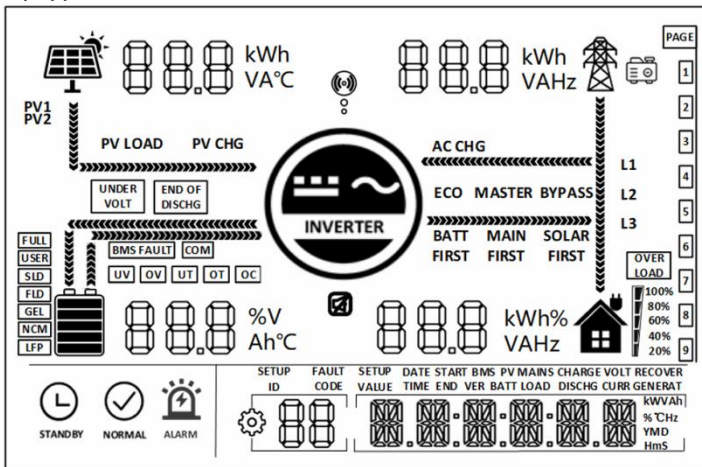



















Display panel



Icons	Functions	Icons	Functions
	Indicates the PV panel		Indicates the utility grid
	Indicates the battery		Indicates the generator
	Indicates the inverter is working		Indicates the home load
	Indicates the inverter is communicating with data collector		Indicates the buzzer muted
			Indicates the direction of energy flow
	Indicates the inverter is standby		Indicates the inverter is working normally
	Indicates error occur		Indicates setting
	Indicates load power 80%~100%		Indicates battery SOC 80%~100%

Add: Building A, Xinlida Industrial Park, Junzibu Village, Guanlan Street, Longhua District, Shenzhen, Guangdong

TEL :0755-23225527 FAX:0755-23225537

	Indicates load power 60%~79%		Indicates battery SOC 60%~79%
	Indicates load power 40%~59%		Indicates battery SOC 40%~59%
	Indicates load power 20%~39%		Indicates battery SOC 20%~39%
	Indicates load power 5%~19%		Indicates battery SOC 5%~19%
	Indicates battery under-voltage		Indicates battery discharge
	Indicates over-load		Indicates BMS fault
	Indicates system communication error		Indicates system under-voltage
	Indicates system over-voltage		Indicates system under-temperature
	Indicates battery is full		Indicates system over-current
	Indicates sealed lead-acid battery		Indicates user defined battery
	Indicates gel lead-acid battery		Indicates flooded lead-acid battery
	Indicates LFP li-ion battery	<b>ECO</b>	Indicates energy-saving mode
<b>PV LOAD</b>	Indicates PV energy is carrying the load	<b>PV CHG</b>	Indicates PV energy is charging the battery
<b>AC CHG</b>	Indicates ACIN energy is charging the battery	<b>MAIN FIRST</b>	Indicates the inverter output mode is mains power first
<b>BYPASS</b>	Indicates the inverter output mode is bypass	<b>SOLAR FIRST</b>	Indicates the inverter output mode is solar first
<b>BATT FIRST</b>	Indicates the inverter output mode is battery first		

● **View real-time data**

In the main screen, press the UP/DOWN keys to view the real-time data of the inverter during operation.

**NOTICE**

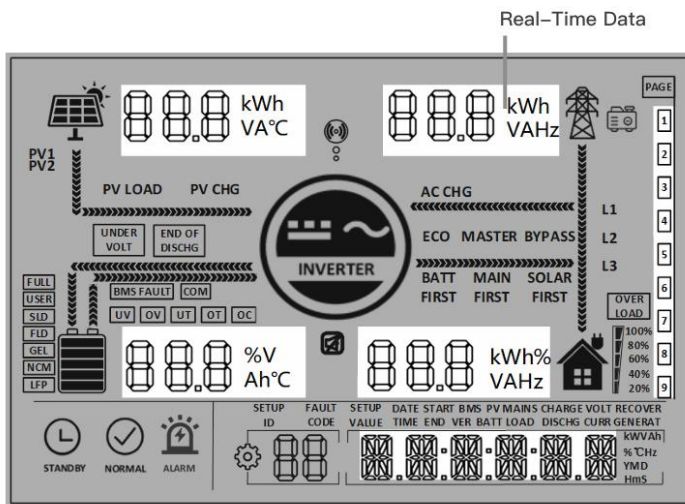

Page	PV side	BAT side	AC IN side	LOAD side	General
1	PV voltage	Batt Voltage	AC in voltage	Single phase voltage	Current Time
2	PV current	Batt Current	AC in current	Single phase Current	Current Date
3	PV power	Batt Voltage	Total AC charging power	Single phase active power	PV Total kWh
4	PV today kWh sink	Batt Current	Today AC charging kWh	Single phase apparent power	Load Total kWh
5	PV side heat temperature	INV Heat Sink Temperature	AC frequency	AC output frequency	RS485 Address
6	PV rated voltage	Batt Rated Voltage	Busbar voltage	AC output rated power	Software Version
7	Max. PV charging current	Max. Batt charging current	Max. AC charging Current	Total AC output active power	/
8			/	Total AC output apparent power	/

● **Setting**

**NOTICE**

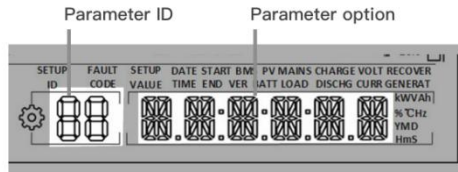
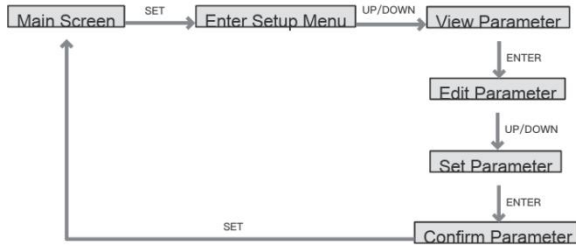

ID	Parameter Meaning	Options	Description
00	Exit	ESC	Exit the setup menu.
01	AC output source priority	UTI <b>default</b>	Utility Priority. Utility power is given priority to the loads, the battery inverts to provide power to the load only when utility power is unavailable.
		SBU	Prioritises the use of PV to power the load and switches back to the mains to power the load only when the battery voltage is lower than the set value in parameter item [4] (when connected to the BMS, according to item [61]). When the battery voltage is higher than the value set in parameter [5] (when connected to the BMS, according to item [62]), it switches back to the PV from the mains to supply the load.
		SOL	PV priority. Switching to mains to power the load when PV is not effective or when the battery is below the setting of parameter item [4].
02	AC output frequency	50.0 <b>default</b>	In mains mode the AC output frequency will adapt to the mains frequency, otherwise the output will follow the preset values.
		60.0	
04	Voltage point of battery switch to utility	43.6 <b>default</b>	When parameter [01]= SBU/SOL, output source will switch to utility from battery when the battery voltage below the preset value. Setting range:40~52V.
05	Voltage point of utility switch to battery	56.8 <b>default</b>	When parameter [01]=SBU/SOL, output source will switch to battery from utility when the battery voltage above the preset value. Range:48~60V.
06	Battery charging mode	SNU <b>default</b>	Solar and utility charging the battery at the same time, solar at the first priority, utility power as a supplement when solar power

Add: Building A, Xinlida Industrial Park, Junzibu Village, Guanlan Street, Longhua District, Shenzhen, Guangdong

TEL :0755-23225527 FAX:0755-23225537

			is sufficient, the utility stops charging. Note: The PV and mains can only be charged at the same time when the mains bypass output is loaded. When the inverter is operating, only PV charging can be initiated, not utility charging.
		CUB	Utility is the first priority in charging, PV charging the battery only when utility is not available.
		CSO	PV is the first priority in charging, utility charging the battery only when solar power is not sufficient.
		OSO	PV charging only, no utility charging.
07	Battery charging current	120A <b>default</b>	Setting range 0~260A
08	Battery type	USER	User-defined, user can set all battery parameter
		SLd	Sealed lead-acid battery.
		FLd	Flooded lead-acid battery.
		GEL default	Gel lead-acid battery.
		L14/ L15/ L16	LFP li-ion battery, 14\15\16 corresponds battery cells number in series.
		N13/ N14	Ternary li-ion battery.
09	Battery bulk charging voltage	57.6 <b>default</b>	Setting range 48V~58.4V, step 0.4V, valid when battery type is custom and lithium battery.
11	Battery float charging voltage	55.2 <b>default</b>	Setting range 48V~58.4V, step 0.4V, this parameter can not be set after the BMS communication is successful.
12	Battery over- discharge voltage (delay off)	42 <b>default</b>	When the battery voltage is lower than the judgement point, and triggers the parameter [13], the inverter output is switched off, the setting range is 40V~48V, the step is 0.4V, valid when battery type is custom and lithium battery.
13	Battery over- discharge voltage delay time	5 <b>default</b>	The battery voltage is lower than parameter [12], and the inverter output is switched off after triggering the delay time set in this parameter, the setting range is 5S~50S, the step is 5S, valid when battery type is custom and lithium battery.
14	Battery under- voltage alarm	44 <b>default</b>	When the battery voltage is lower than this judgement point, the device will under-voltage alarm, the output will not be switched off, the setting range is 40V~52V, the step is 0.4V, valid when battery type is custom and lithium battery.
15	Battery under-voltage limit voltage	40 <b>default</b>	When the battery voltage is lower than the value of this parameter item, the output will be switched off immediately. Setting range 40V~52V, step 0.4V, valid when battery type is custom and lithium battery.
16	Battery equalization charging	DIS	Disable equalization charging.
		ENA <b>default</b>	Enable equalization charging, parameter can be set only when battery type is FLd\SLd\USER.
17	Battery equalization charging voltage	58	Setting range: 48V~58V, increment of each click is 0.4V, parameter can be set only when battery type is FLd\SLd\USER.
18	Battery equalization charging duration	120	Setting range: 5min~900min, increment of each click is 5min, parameter can be set only when battery type is FLd\SLd\USER.
19	Battery equalization	120	Setting range: 5min~900min, increment of each click is

Add: Building A, Xinlida Industrial Park, Junzibu Village, Guanlan Street, Longhua District, Shenzhen, Guangdong

TEL :0755-23225527 FAX:0755-23225537

	charging delay time		5min, parameter can be set only when battery type is FLd\SLd\USER.
20	Battery equalization charging interval	30	Setting range: 0~30days, increment of each click is 1day, parameter can be set only when battery type is FLd\SLd\USER.
21	Battery equalization charging stop-start	DIS <b>default</b>	Start equalization charging immediately.
		ENA	Stop equalization charging immediately.
22	Power saving mode	DIS <b>default</b>	Disable power saving mode.
		ENA	Enable energy-saving mode, when the load power is less than 25W, the output of the inverter will switch off after a 5-minute delay. When the load exceeds 25W, the inverter will restart automatically.
23	Over-load restart	DIS	Disable overload automatic restart, if an overload occurs to shut down the output, the machine will not be restored to power on again.
		ENA <b>default</b>	Enable overload automatic restart. If an overload occurs that shuts down the output, the machine delays for 3 minutes before restarting the output. After accumulating 5 times, it will not restart again.
24	Over-temperature restart	DIS	Disable over-temperature automatic restart, if over-temperature occurs to switch off the output machine no longer switch on the output.
		ENA <b>default</b>	Enable over-temperature automatic restart, if over-temperature occurs the output is switched off, it will be switched on when the temperature drops.
25	Buzzer alarm	DIS	Disable buzzer alarm.
		ENA <b>default</b>	Enable buzzer alarm.
26	Power source switching reminder	DIS	Disable reminder when the status of the input power source changes.
		ENA <b>default</b>	Enable alert when the status of the main input source changes.
27	Inverter overload switch to bypass	DIS	Disable automatic switching to mains to power the load in the event of an inverter overload.
		ENA <b>default</b>	Automatic switching to mains to power the load in the event of an inverter overload.
28	Max. utility charging current	120A	Setting range: 0~120A.
30	RS485 address	ID:1	RS485 address setting range: 1~254.
32	RS485 communication	SLA <b>default</b>	RS485 PC & Remote Monitoring Protocol.
		BMS	RS485 BMS communication function.
		CAN	CAN BMS communication function.
33	BMS communication	When item [32] = BMS, the corresponding lithium battery manufacturer brand should be selected for communication.	
		WOW <b>default</b>	PAC=PACE, RDA=RITAR, AOG=ALLGRAND, OLT=OLITER, CEF=CFE, XYD=SUNWODA, DAQ=DYNESS, WOW=SRNE, PYL=PYLONTECH, POW=POWMr, UOL=VILION.
34	Feed back & hybrid output function	DIS <b>default</b>	Disable this function.
		MIX LOD	When parameter [01]=UTI, the solar energy is prioritised to charge the battery and any excess energy will be used to power the load. With an anti-backflow function, the PV energy is not feed back into the grid.

Add: Building A, Xinlida Industrial Park, Junzibu Village, Guanlan Street, Longhua District, Shenzhen, Guangdong

TEL :0755-23225527 FAX:0755-23225537

		ON GRD	When parameter [01]=UTI, the solar energy is given priority charging, and when the load demand is met, the remaining power will be fed back to the grid.
35	Battery under voltage recover point	52	When the battery is under-voltage, the battery voltage needs to be higher than this setting value in order to restore the battery inverter AC output, setting range: 44V~54.4V.
37	Battery full recharge voltage point	52	Inverter stops charging when the battery is full. Inverter resumes charging when the battery voltage below this value. Setting range: 44V~54V.
38	AC output voltage	230	Setting range: 200/208/220/230/240Vac.
39	Charging current limiting method (when BMS is enabled)	[SET] The maximum battery charging current is limited according to the setting in [07].	
		[BMS] Default Maximum battery charging current is limited according to the current limit value of the BMS.	
		[INV] Maximum battery charging current is limited by the machine's derating logic.	
40	1 <sup>st</sup> slot start charging	00:00:00	Setting range: 00:00:00-23:59:00
41	1 <sup>st</sup> slot end charging	00:00:00	Setting range: 00:00:00-23:59:00
42	2 <sup>nd</sup> slot start charging	00:00:00	Setting range: 00:00:00-23:59:00
43	2 <sup>nd</sup> slot end charging	00:00:00	Setting range: 00:00:00-23:59:00
44	3 <sup>rd</sup> slot start charging	00:00:00	Setting range: 00:00:00-23:59:00
45	3 <sup>rd</sup> slot end charging	00:00:00	Setting range: 00:00:00-23:59:00
46	Time slot charging function	DIS default	Disable this function.
		ENA	When the time slot mains charging / carrying loads function is enabled, the power supply mode will change to SBU and switch to mains charging only during the set charging period or when the battery is over-discharged. If the time slot discharging function is enabled at the same time, the system power supply mode will change to UTI, and will only switch to the mains for charging during the set charging period, and switch to the battery inverter power supply during the set discharging period or when the mains is outaged.
47	1 <sup>st</sup> slot start discharging	00:00:00	Setting range: 00:00:00-23:59:00
48	1 <sup>st</sup> slot end discharging	00:00:00	Setting range: 00:00:00-23:59:00
49	2 <sup>nd</sup> slot start discharging	00:00:00	Setting range: 00:00:00-23:59:00
50	2 <sup>nd</sup> slot end discharging	00:00:00	Setting range: 00:00:00-23:59:00
51	3 <sup>rd</sup> slot start discharging	00:00:00	Setting range: 00:00:00-23:59:00
52	3 <sup>rd</sup> slot end discharging	00:00:00	Setting range: 00:00:00-23:59:00
53	Time slot discharging function	DIS default	Disable this function.
		ENA	When the time slot battery discharging function is enabled, the power supply mode will be switched to UTI, and the system will switch to battery inverter power supply only during the set discharge period or when the mains is outaged.
54	Local date	00:00:00	YY/MM/DD. Setting range: 00:01:01-99:12:31
55	Local time	00:00:00	Setting range: 00:00:00-23:59:59
56	Leakage current detection protection	DIS default	Disable detecting Leakage current value.
		ENA	Enable detecting Leakage current value.
57	Stop charging current	2	Charging stops when the charging current is less than

Add: Building A, Xinlida Industrial Park, Junzibu Village, Guanlan Street, Longhua District, Shenzhen, Guangdong

TEL :0755-23225527 FAX:0755-23225537

			this setting (unit: A).
58	Discharging alarm SOC	15	Triggers an alarm when the battery SOC is less than the set value (unit:%, valid only when BMS communication is normal)
59	Discharging cutoff SOC	5	Stops discharging when the battery SOC is less than the set value (unit:%, valid only when BMS communication is normal)
60	Charging cutoff SOC	100	Stops charging when the battery SOC is higher than the set value (unit:%, valid only when BMS communication is normal)
61	Switching to utility SOC	10	Switch to utility power when the battery SOC is less than this setting value (unit:%, valid only when BMS communication is normal)
62	Switching to inverter SOC	100	Switches to inverter output mode when SOC is higher than this setting value (unit:%, valid only when BMS communication is normal)
63	N-PE bonding automatic switching function	DIS default	Disable automatic switching of N-PE connections.
		ENA	Enable automatic switching of N-PE connections.
67	On grid max power	0 default	you can set the max on-grid power(less than the inverter rated power)
70	Insulation impedance detection	DIS default	Disable detecting insulation impedance value.
		ENA	Enable detecting insulation impedance value.
71	PV power priority	First to load	PV energy is prioritized to supply the load: PV power supply logic: Load-Grid-battery charge
		First to charge default	PV energy is prioritized to charge the battery;PV power supply logic: Battery charge-Load-Grid

## 6.2 AC output mode

The AC output mode corresponds to parameter setting item 01 and 34, which allows the user to set the AC output power source manually.

- **Utility Priority Output 01 UTI (default)**

Utility at first priority, utility and solar provide power to load at the same time when solar is available, battery will provide power to load only when utility power is not available.(Priority: utility>solar>battery)

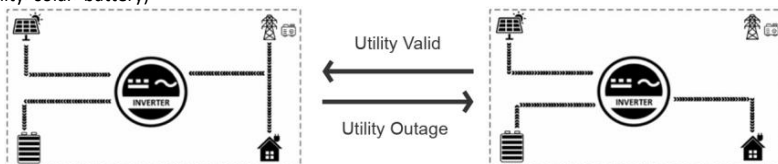

- **Solar and Utility Hybrid Output 34 MIX LOD**

In UTI mode, when not connected to the battery or when the battery is full, the solar and the utility supply power to the load at the same time.(Priority: solar>utility>battery)

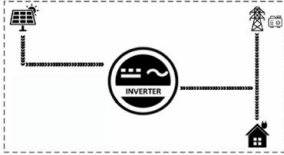

Battery disconnected

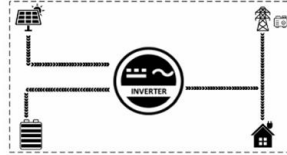

Battery Full

● **Solar Priority Output 01 SOL**

Solar provides power to the loads as first priority. If solar is not available, the utility will be used as a supplement to provide power to the loads. This mode maximize solar energy while maintaining battery power and is suitable for areas with relatively stable power grids.(Priority: solar>utility>battery)



← Solar Sufficient  
Solar Insufficient →



● **Inverter Priority Output 01 SBU**

Solar provides power to the loads as first priority. If solar is not sufficient or not available, the battery will be used as a supplement to provide power to the loads. When the battery voltage reaches the value of parameter 04 (Voltage point of battery switch to utility ) will switch to utility to provide power to the load, This model makes maximum use of DC energy and is used in areas where the grid is stable. (Priority: solar>battery>utility)



← Battery Available  
Battery Under-voltage →

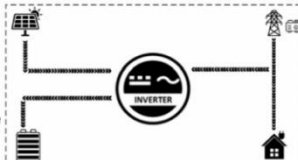

**6.3 Battery charging mode**

The charging mode corresponds to parameter setting item 06, which allows the user to set the charging mode manually.

● **Hybrid Charging SNU(default)**

Solar and utility charging the battery at the same time, solar at the first priority, utility power as a supplement when solar power is not sufficient. This is the fastest way to charge and is suitable for areas with low power supply, providing customers with sufficient back-up power.(Source priority: solar>utility)

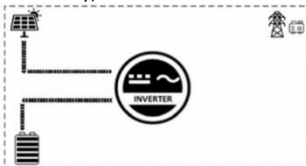

← Solar Sufficient  
Solar Insufficient →



● **Utility Priority Charging CUB**

The utility power gives priority to charging the battery, and PV charging is only activated when the utility power is not available. (Source priority: utility>solar)

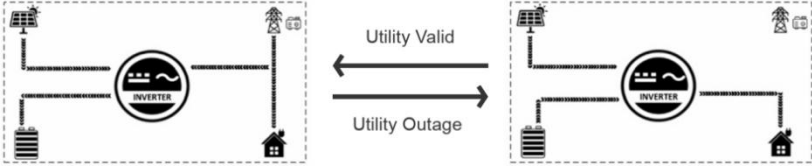

● **Solar Priority Charging CSO**

Solar priority charging, with utility charging only activated when the solar fails. By making full use of solar power during the day and switching to utility charging at night, battery power can be maintained and is suitable for applications in areas where the grid is relatively stable and electricity prices are more expensive. (Source priority: solar>utility)

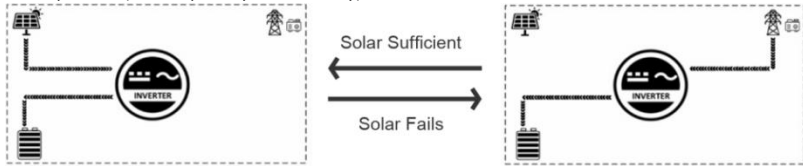

● **Only Solar Charging OSO**

Solar charging only, no mains charging is activated. This is the most energy-efficient method, with all the battery power coming from solar energy, and is usually used in areas with good radiation conditions.



**6.4 Time-slot charging/discharging function**

12KW output three-phase integrated machine series is equipped with a time-slot charging and discharging function, which allows users to set different charging and discharging periods according to the local peak and valley tariffs, so that the utility power and PV energy can be used rationally.

When mains electricity is expensive, the battery inverter is used to carry the load; when the mains electricity is cheap, the mains electricity is used to carry the load and charge, which can help customers to save electricity costs to the greatest extent.

The user can turn on/off the time-slot charging/discharging function in setup menu parameter 46 and 53, and set charging and discharging slot in parameter 40-45, 47-52. Below are examples for users to understand the function.

**NOTICE**

Before using this function for the first time, please set the local time in parameter items 54, 55, then the user can set the corresponding time slot according to the local peak and valley tariff charges.

**Peak-Valley Electricity Tariff**

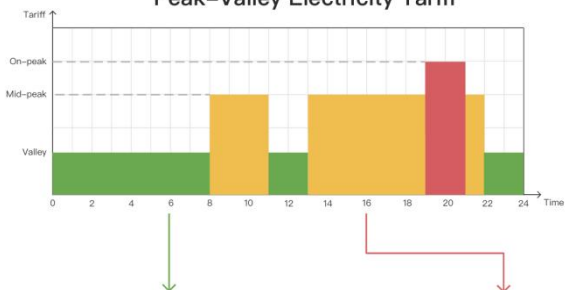

**Time-slot Utility Charging/Carrying Function**



With 3 definable periods, the user can freely set the mains charging/carrying time within the range of 00:00 to 23:59. During the time period set by the user, if PV energy is available, PV energy will be used first, and if PV energy is not available or insufficient, utility energy will be used as a supplement.

**Time-slot Battery Discharging Function**



With 3 definable time periods, users can freely set the battery discharge time within the range of 00:00 to 23:59. During the time period set by the user, the inverter will give priority to the battery inverter to carry the load, and if the battery power is insufficient, the inverter will automatically switch to mains power to ensure stable operation of the load.

## 6.5 Battery parameter

### Li-ion battery

Parameter/Battery type	LFP			User-defined
	L16	L15	L14	
Over-voltage cut-off voltage	60V	60V	60V	60v
Equalization charging voltage	-	-	-	40~60V settable
Bulk charging voltage	56.8V	53.2V	49.2V	40~60V settable
Float charging voltage	56.8V	53.2V	49.2V	40~60V settable
Under-voltage alarm voltage	49.6V	46.4V	43.2V	40~60V settable
Under-voltage cut-off voltage	48.8V	45.6V	42V	40~60V settable

Add: Building A, Xinlida Industrial Park, Junzibu Village, Guanlan Street, Longhua District, Shenzhen, Guangdong

TEL :0755-23225527 FAX:0755-23225537

Discharging limit voltage	46.4V	43.6V	40.8V	40~60V settable
Over-discharge delay time	30s	30s	30s	1~30s settable
Equalization charging duration	-	-	-	0~600min settable
Equalization charging interval	-	-	-	0~250d settable
Bulk charging duration	120min settable	120min settable	120min settable	10~600min settable

**NOTICE**

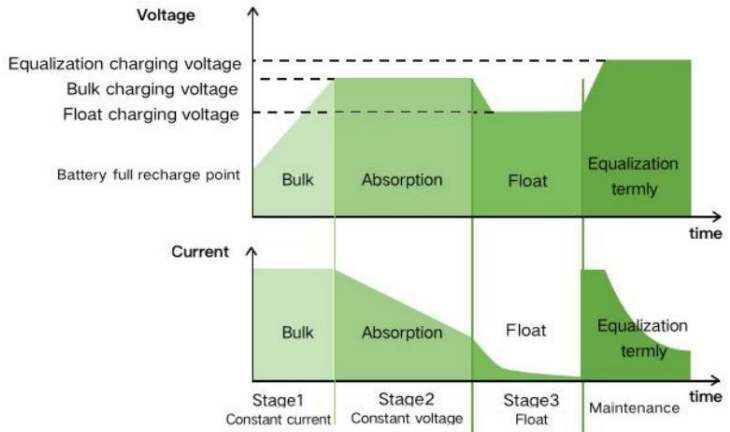

# 7. Communication

## 7.1 Overview

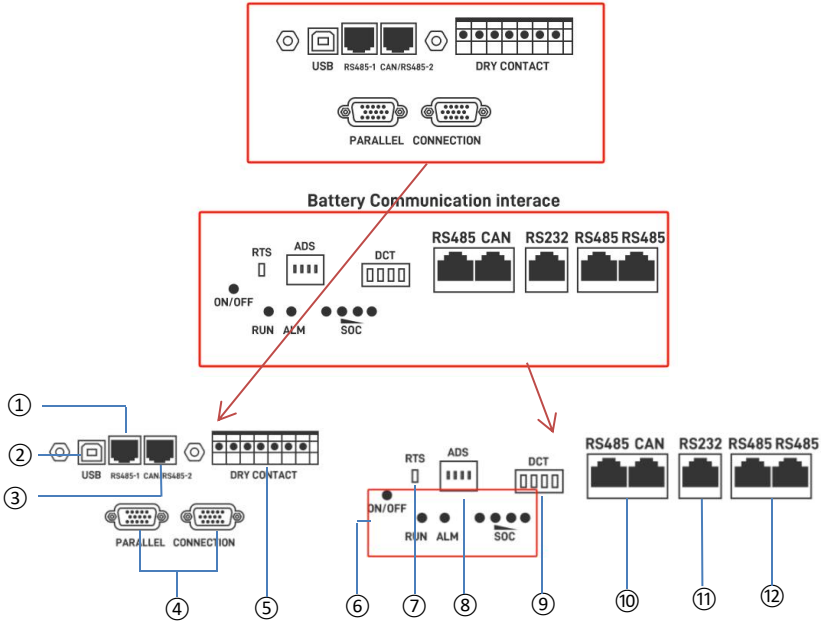

Inverter Communication interface	① RS485-1 port	② USB-B port	③ CAN/RS485-2 port
	④ Parallel connection port		⑤ Dry contact port
Battery Communication interface	⑥ LED Indicator	⑦ RST	⑧ ADS
	⑨ DCT	⑩ RS485/CAN (connect to inverter)	⑪ RS232 (connect to computer)
	⑫ RS485/RS485 (Parallel connection)		

## 7.2 Inverter Communication Interface

### 7.2.1 RS485-1 Port

The RS485-1 port is used to connect to the Wi-Fi/GPRS data acquisition module, which allows the user to view the operating status and parameters of the inverter via the mobile phone APP.

**NOTICE**

The Wi-Fi/GPRS data acquisition module need to be purchased separately. User can scan the QR code to download the mobile APP. SU

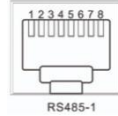

RJ45	Definition
Pin 1	5V
Pin 2	GND
Pin 3	/
Pin 4	/
Pin 5	/
Pin 6	/
Pin 7	RS485-A
Pin 8	RS485-B

### 7.2.2 USB-B Port

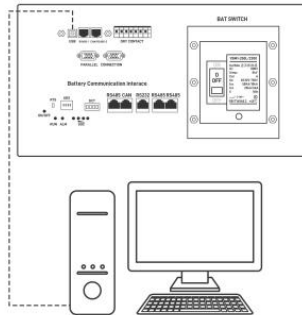

**USB typeB** Users can use the host computer software to read and modify the device parameters through this port. If you need the installation package of the host computer software, you can download it from the official website of SRNE or contact us to get the installation package.

Add: Building A, Xinlida Industrial Park, Junzibu Village, Guanlan Street, Longhua District ,Shenzhen, Guangdong

TEL :0755-23225527 FAX:0755-23225537

### 7.2.3 CAN/RS485-2 Port

The RS485-2 port is used to connect to the BMS of Li ion battery.

**NOTICE**

If you use a normal RJ45 network cable, please check the pin assignment, pin 1 & pin 2 usually need to be cut off for normal use.

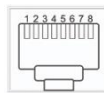

RJ45	Definition
Pin 1	5V
Pin 2	GND
Pin 3	/
Pin 4	CANH
Pin 5	CANL
Pin 6	/
Pin 7	RS485-A
Pin 8	RS485-B

### 7.2.4 Dry contact

Dry contact port with 4 functions: 1. Remote switch on/off; 2. Switching signal output; 3. Battery temperature sampling; 4. Generator remote start/ stop

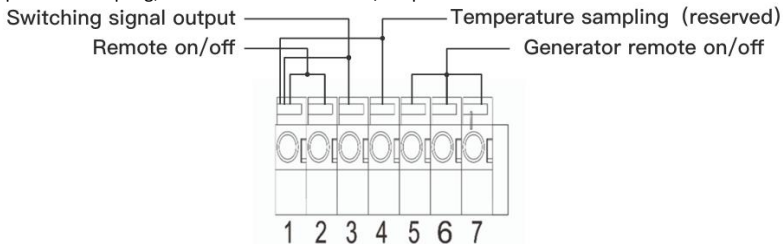

Function	Description
Remote switch on/off	When pin 1 is connected with pin 2, the inverter will switched off the AC output. When pin1 is disconnected from pin2, the inverter outputs normally.
Switching signal output	When the voltage of battery reaches the <i>under-voltage limit voltage</i> (parameter 15) , pin 3 to pin 1 voltage is 0V, When the battery charging/discharging normally pin 3 to pin 1 voltage is 5V.
Temperature sampling (reserved)	Pin 1 & Pin 4 can be used for battery temperature sampling compensation.
Generator remote start/stop	When the voltage of battery reaches the <i>under-voltage alarm voltage</i> (parameter 14) or <i>voltage point of utility switch to battery</i> (parameter 04), pin 6 to pin 5 normal open, pin 7 to pin 5 normal close. When the voltage of battery reaches the <i>voltage point of battery switch to utility</i> (parameter 05) or battery is full. pin 6 to pin 5 normal close, pin 7 to pin 5 normal open. (Pin 5/6/7 outputs 125Vac/1A, 230Vac/1A,30Vdc/1A)

**NOTICE**

If you need to use the remote start/stop function of the generator with dry contact, ensure that the generator has ATS and supports remote start/stop.

Add: Building A, Xinlida Industrial Park, Junzibu Village, Guanlan Street, Longhua District ,Shenzhen, Guangdong

TEL :0755-23225527 FAX:0755-23225537

## 7.3 Battery Communication Interface

### 7.3.1 LED Indicator

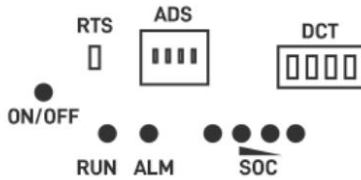

Four green capacity indicators, a red alarm indicator, a green running indicator and a switch indicator.

### 7.3.2 SOC capacity indicator

Condition		Charge				Discharge			
Capacity indicator lamp		L1	L2	L3	L4	L1	L2	L3	L4
power (%)	0~25%	Flash 2	OFF	OFF	OFF	ON	OFF	OFF	OFF
	25~50%	ON	Flash 2	OFF	OFF	ON	ON	OFF	OFF
	50~75%	ON	ON	Flash 2	OFF	ON	ON	ON	OFF
	75~100~	ON	ON	ON	Flash 2	ON	ON	ON	ON
Running indicator light		ON				Flash 3			

### 7.3.3 Status indicator

Status	Warning/Normal /Protection	ON/OFF	Run	Alert	LED Battery Level Indicator				Explain	
		●	●	●	●	●	●	●		●
Shut down	Sleep mode	ON	OFF	OFF	OFF	OFF	OFF	OFF	OFF	Light off
Standby	Normal	ON	Flash 1	OFF	According to the electricity indication				Standby mode	
	Warning	ON	Flash 1	Flash 3					Module low voltage	
charge	Normal	ON	ON	OFF	According to the power indicator (the maximum LED of the power indicator flashes 2)				The maximum power LED flashes (flash 2), and the ALM does not flash during the overshoot.	
	Warning	ON	ON	Flash 3						
	Overcharge Protection	ON	ON	OFF	ON	ON	ON	ON	If there is no mains supply, the indicator turns to standby	
	Temperature, over current, failure, protection	ON	OFF	ON	OFF	OFF	OFF	OFF	OFF	Stop charging
discharge	Normal	ON	Flash 3	OFF						
	Warning	ON	Flash 3	Flash 3						
	UVLO	ON	OFF	OFF	OFF	OFF	OFF	OFF	OFF	Stop charging
	Temperature, over current, short out, reversed polarity ,FAIL-SAFE	ON	OFF	ON	OFF	OFF	OFF	OFF	OFF	Stop discharge
Invalid		OFF	OFF	ON	OFF	OFF	OFF	OFF	OFF	Stop charging and discharging

#### LED flashing description

Flashing mode	ON	OFF
Flash 1	0.25s	3.75s
Flash 2	0.5s	0.5S
Flash 3	0.5s	1.5s

### 7.3.4 Communication area

## Battery Communication interface

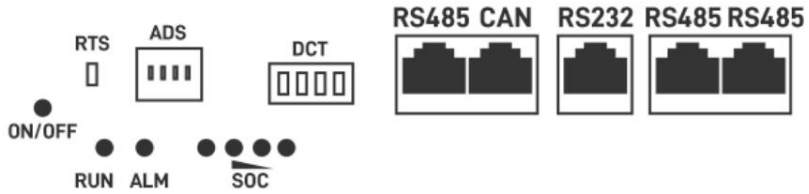

1. RS232: BMS can communicate with upper computer through RS232 interface, so as to monitor various information of battery, including battery voltage, current, temperature, status and battery production information, etc. the default baud rate is 9600bps.
2. RS485: with dual RS485 interface, you can view the information of pack. The default baud rate is 9600bps. If it is necessary to communicate with the monitoring equipment through RS485, the monitoring equipment is used as the host, polling data according to the address, and the address setting range is 1 ~ 15.
3. CAN: CAN communication, baud rate 9600bps.
4. RS485 and CAN: The user can communicate with the inverter through these two interfaces.
5. RS485 add RS232: The users can connect to the computer through these two interfaces.
6. DCT: Dry contact interface.
7. Rst: reset button.
8. ADS: dial switch

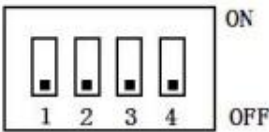

#### 9. Interface diagram

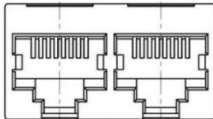

CAN and RS485 interface



Dry contact

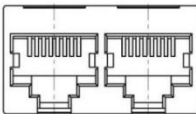

Parallel communication port

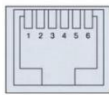

communication interface

Add: Building A, Xinlida Industrial Park, Junzibu Village, Guanlan Street, Longhua District, Shenzhen, Guangdong

TEL :0755-23225527 FAX:0755-23225537

10. Definition of electrical interface

RS232 -- 6P6C vertical RJ11 plug	
RJ11 pin	Definition Description
2	NC
3	TX(Single board)
4	RX(Single board)
5	GND

**RS485 and CAN Interface**

RS485 - 8P8C vertical RJ45 socket		CAN - 8P8C vertical RJ45 socket	
RJ45 pin	Definition Description	RJ45 pin	Definition Description
1、 8	RS485-B1	9、 10、 11、 14、 16	NC
2、 7	RS485-A1	12	CANL
3、 6	GND	13	CANH
4、 5	NC	15	GND

**Parallel communication port**

RS485 - 8P8C vertical RJ45 socket		RS485 - 8P8C vertical RJ45 socket	
RJ45 pin	Definition Description	RJ45 pin	Definition Description
1、 8	RS485-B	9、 16	RS485-B
2、 7	RS485-A	10、 15	RS485-A
3、 6	GND	11、 14	GND
4、 5	NC	12、 13	NC

11. Bluetooth communication

BMS can communicate with APP through Bluetooth to monitor various information of the battery, including battery voltage, current, temperature, status, SOC, SOH, and battery production information, etc. The default baud rate is 9600bps.

12. WiFi communication

Press and hold the reset button for 10-13 seconds. After all the flow lights are on, it will turn into a state where one light is on. Then release it (except for the ON/OFF light) and wait for 8 seconds to see the new device in the app's device addition section.

## 7.4.4 WiFi Function Operation Instructions

Android: Scan QR code to download



IOS entrance:

Search for PACE EX download in the App Store

<https://apps.apple.com/cn/app/6461723294>

### Local Control (BLE)

When the device is in the standby network state, click the local control button to search for the device on the local control page. If a single or a small number of machines are running, you can directly click on local operation (Bluetooth) to discover and find the corresponding device for local control. Click on the device to enter the device control page.

### WiFi remote control



Add: Building A, Xinlida Industrial Park, Junzibu Village, Guanlan Street, Longhua District, Shenzhen, Guangdong

TEL :0755-23225527 FAX:0755-23225537

## Equipment control and data display



## 8. Fault and Remedy

### 8.1 Fault code

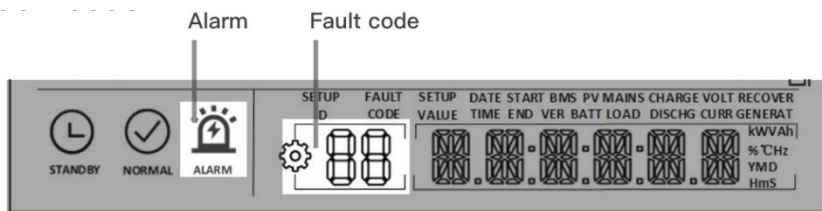

Fault Code	Meaning	Does it Affect the outputs	Instructions
01	BatVoltLow	Yes	Battery under-voltage alarm
02	BatOverCurrSw	Yes	Battery discharge over-current, software protection
03	BatOpen	Yes	Battery disconnected alarm
04	BatLowEod	Yes	Battery under-voltage stop discharging alarm
05	BatOverCurrHw	Yes	Battery over-current hardware protection
06	BatOverVolt	Yes	Battery over-voltage protection
07	BusOverVoltHw	Yes	Busbar over-voltage hardware protection
08	BusOverVoltSw	Yes	Busbar over-voltage software protection
09	PvVoltHigh	Yes	PV input over-voltage protection
10	PvBoostOCSw	No	Boost circuit over-current software protection
11	PvBoostOCHw	No	Boost circuit over-current hardware protection
12	SpiCommErr	Yes	Master-slave chip SPI communication failure
13	OverloadBypass	Yes	Bypass overload protection
14	OverloadInverter	Yes	Inverter overload protection
15	AcOverCurrHw	Yes	Inverter over-current hardware protection
16	AuxDspReqOffPWM	Yes	Slave chip request switch off failure
17	InvShort	Yes	Inverter short-circuit protection
18	Bussoftfailed	Yes	Inverter busbar soft start failed
19	OverTemperMppt	No	MPPT heat sink over-temperature protection

Add: Building A, Xinlida Industrial Park, Junzibu Village, Guanlan Street, Longhua District, Shenzhen, Guangdong

TEL :0755-23225527 FAX:0755-23225537

20	OverTemperInv	Yes	Inverter heat sink over-temperature protection
21	FanFail	Yes	Fan failure
22	EEPROM	Yes	Reservoir failure
23	ModelNumErr	Yes	Wrong model
24	Busdif	Yes	Busbar voltage imbalance
25	BusShort	Yes	Busbar short circuit
26	Rlyshort	Yes	Inverter output back flow to bypass
28	LinePhaseErr	Yes	Utility input phase fault
29	BusVoltLow	Yes	Busbar under-voltage protection
30	BatCapacityLow1	No	Battery SOC below 10% alarm (Only enable BMS take effect)
31	BatCapacityLow2	No	Battery SOC below 5% alarm (Only enable BMS take effect)
32	BatCapacityLowStop	Yes	Battery dead (Only enable BMS take effect)
56	Low insulation resistance fault	No	PV abnormally low impedance to ground.
57	Leakage current overload fault	Yes	System leakage current exceeds limit.
58	BMSComErr	No	BMS communication failure
59	BMSErr	No	BMS failures occur
60	BMSUnderTem	No	BMS under-temperature alarm (Only enable BMS take effect)
61	BMSOverTem	No	BMS over-temperature alarm (Only enable BMS take effect)
62	BMSOverCur	No	BMS over-current alarm (Only enable BMS take effect)
63	BMSUnderVolt	No	BMS under-voltage alarm (Only enable BMS take effect)
64	BMSOverVolt	No	BMS over-voltage alarm(Only enable BMS take effect)

## 8.2 Troubleshooting

Fault Code	Meaning	Causality	Remedy
/	Screen no display	No power input, or in sleep mode.	Closing the circuit breaker. Ensure the rocker switch is ON. Push any button on the panel to exit sleep mode
01	Battery under-voltage	The battery voltage is lower than the value set in parameter [14].	Charge the battery and wait until the battery voltage is higher than the value set in the parameter item [14].
03	Battery not connected	The battery is not connected, or the BMS in discharge protection	Check whether the battery is reliably connected; check whether the circuit breaker of the battery is not closed; ensure that the BMS of the Li-ion battery can communicate properly.
04	Battery over-discharge	The battery voltage is lower than the value	Manual reset: Power off and restart. Automatic reset: charge the battery so

Add: Building A, Xinlida Industrial Park, Junzibu Village, Guanlan Street, Longhua District, Shenzhen, Guangdong

TEL :0755-23225527 FAX:0755-23225537

		set in the parameter [12].	that the battery voltage is higher than the value set in the parameter item [35].
06	Battery over-voltage when charging	Battery is in over-voltage condition.	Manually power off and restart. Check to see if the battery voltage exceeds the limit. If it exceeds, the battery needs to be discharged until the voltage is below the battery's over-voltage recovery point.
13	Bypass over-load (software detection)	Bypass output power or output current overload for a certain period of time.	Reduce the load power and restart the device. Please refer to item 11 of the protection features for more details.
14	Inverter over- load (software detection)	Inverter output power or output current overload for a certain period of time.	
19	Heat sink of PV input over-temperature (software detection)	Heat sink of PV input temperature exceeds 90°C for 3s.	Resume normal charge and discharge when the temperature of the heat sink has cooled to below the over-temperature recovery temperature.
20	Heat sink of inversion over-temperature (software detection)	Heat sink of inversion temperature exceeds 90°C for 3s.	
21	Fan failure	Fan failure detects by hardware for 3s.	Manually toggle the fan after switching off to check for blockage by foreign objects.
26	AC Input relay short-circuit	Relay for AC input sticking	Manually power off and restart; if the fault reappears after restarting, You need to contact the after-sales service to repair the machine.
28	Utility input phase fault	AC input phase does not coincide with AC output phase	Ensure that the phase of the AC input is the same as the phase of the AC output, e.g. if the output is in split-phase mode, the input must also be in split-phase.

**NOTICE**

If you encounter a fault with the product that cannot be solved by the methods in the table above, please contact our after-sales service for technical support and do not disassemble the equipment yourself.

## 9. Protection and Maintenance

### 9.1 Protection features

No	Protection Feature	Instruction
1	PV input current/power limiting protection	When the charging current or power of the PV array configured exceeds the PV input rated value, the inverter will limit the input power and charge at the rated.
2	PV input over-voltage	If the PV voltage exceeds the maximum value allowed by the hardware, the machine will report a fault and stop the PV boost to output a sinusoidal AC wave.
3	PV night reverse current protection	At night, the battery is prevented from discharging through the PV module because the battery voltage is greater than the

Add: Building A, Xinlida Industrial Park, Junzibu Village, Guanlan Street, Longhua District, Shenzhen, Guangdong

TEL :0755-23225527 FAX:0755-23225537

		voltage of PV module.
4	AC input over-voltage protection	When the AC input voltage of each phase exceeds 140V, the mains charging will be stopped and switched to the inverter mode.
5	AC input under-voltage protection	When the AC input voltage of each phase below 90V, the utility charging will be stopped and switched to the inverter mode.
6	Battery over-voltage protection	When the battery voltage reaches the over-voltage cut-off point, the PV and the utility will automatically stop charging to prevent the battery from being overcharged and damaged.
7	Battery under-voltage protection	When the battery voltage reaches the under-voltage cut-off point, the inverter will automatically stop the battery discharge to prevent damage from over-discharging the battery.
8	Battery over-current protection	After a period when the battery current exceeds that allowed by the hardware, the machine will switch off the output and stop discharging the battery.
9	AC output short-circuit protection	When a short-circuit fault occurs at the load output terminal, the AC output is immediately turned off and turned on after 1 second. If the output load terminal is still short-circuited after 3 attempts, the inverter must be manually restarted after first removing the short-circuit fault from the load before the normal output can be restored.
10	Heat sink over-temperature protection	When the internal temperature of the inverter is too high, the inverter will stop charging and discharging; when the temperature returns to normal, the inverter will resume charging and discharging.
11	Inverter over-load protection	After triggering the overload protection the inverter will resume output after 3 minutes, 5 consecutive overloads will switch off the output until the inverter is restarted. (102%<load< load < 125%) ±10%: error and output shutdown after 10s. Load > 125% ±10%: error reported and output switched off after 5s.
12	AC output reverse	Prevents AC back flow from the battery inverter to the bypass AC input.
13	Bypass over-current protection	Built-in AC input over-current protection circuit breaker.
14	Bypass phase inconsistency protection	When the phase of the bypass input and the phase of the inverter split do not match, the inverter disables switching to the bypass output to prevent the load from dropping out or short-circuiting when switching to the bypass.

## 9.2 Maintenance

To maintain optimum and long-lasting working performance, we recommend that the following items are checked twice a year.

1. Ensure that the airflow around the product is not blocked and remove any dirt or debris from the radiator.
2. Check that all exposed conductors are not damaged by sunlight, friction with other surrounding objects, dry rot, insect or rodent damage, etc. The conductors need to be repaired or replaced if necessary.
3. Verify that the indications and displays are consistent with the operation of the equipment, note

Add: Building A, Xinlida Industrial Park, Junzibu Village, Guanlan Street, Longhua District, Shenzhen, Guangdong

TEL :0755-23225527 FAX:0755-23225537

any faults or incorrect displays and take corrective action if necessary.

4. Check all terminals for signs of corrosion, insulation damage, high temperatures or burning/discolouration and tighten terminal screws.
5. Check for dirt, nesting insects and corrosion, clean anti insects net as required.
6. If the lightning arrester has failed, replace the failed arrester in time to prevent lightning damage to the inverter or other equipment of the user.

**⚠ DANGER**

Make sure that the product is disconnected from all power sources and that the capacitors are fully discharged before carrying out any checks or operations to avoid the risk of electric shock.

The Company shall not be liable for damage caused by:

1. Damage caused by improper use or use in a wrong location.
2. Photovoltaic modules with an open circuit voltage exceeding the maximum permissible voltage.
3. Damage caused by the operating temperature exceeding the restricted operating temperature range
4. Dismantling and repair of the inverter by unauthorised persons.
5. Damage caused by force majeure: damage during transport or handling of the product.

## 10. Data sheet

MODEL	AO-MB51600-AC380V-12KW-EU	AO-MB51400-AC380V-12KW-EU	AO-MB51300-AC380V-12KW-EU
<b>BATTERY TECHNICAL SPECIFICATION</b>			
Battery model	MB51600-300A-HWB	MB51400-300A-HWB	MB51300-300A-HWB
Number of batteries	1		
Battery Energy	30.72kWh	20.48kWh	15.36kWh
Battery Capacity	600AH	400AH	300AH
Weight	238KG	215KG	173KG
Dimension L x D x H (mm)	750*500*845mm	660*500*850mm	660*470*704mm
Battery Type	LiFePO4		
Battery Rated Voltage	51.2V		
Battery Working Voltage Range	44.8 ~ 57.6V		
Maximum Charging Current	300A		
Maximum Discharging Current	300A		
DOD	80%		
Designed Life-span	>6000 Cycles @ 0.2C/25℃ Charging/Discharging at 80%DOD, Until 80% Capacity.		
<b>INVERTER TECHNICAL SPECIFICATION</b>			
Inverter model	SPI-12K-H3P		
<b>PV CHARGE</b>			
Solar Charge Type	MPPT*2		
Maximum Input Power	9000W/9000W		
PV Charging Current Range	22A+22A		
PV Operating Voltage Range	800Vdc/800Vdc		
MPPT Voltage Range	200-650Vdc		
<b>AC CHARGE</b>			

Add: Building A, Xinlida Industrial Park, Junzibu Village, Guanlan Street, Longhua District ,Shenzhen, Guangdong

TEL :0755-23225527 FAX:0755-23225537

Frequency Range	50/60Hz
Input Voltage Range	phase voltage 170~280V, line voltage 305~485V
Bypass Overload Current	35A
<b>AC OUTPUT</b>	
Rated Output Power	12000W
Max. Peak Power	24000W
Rated Output Voltage	230/400Vac (three-phase)
Load Capacity of Motors	6HP
Rated AC Frequency	50/60Hz
Waveform	Pure Sine Wave
Switch Time	10ms ( typical )
<b>BATTERY INVERTER OUTPUT</b>	
Rated Output Power	12000W
Maximum Peak Power	24000W
Power Factor	1
Rated Output Voltage (Vac)	230/400Vac (three-phase)
Frequency	50Hz $\pm$ 0.3Hz/60Hz $\pm$ 0.3Hz
Auto Switch Period	<15ms
THD	<3%
<b>GENERAL DATA</b>	
Protection Degree	IP20, Indoor Only
Operating Temperature Range	-15~55 $^{\circ}$ C, >45 $^{\circ}$ C derated
Noise	<60dB
Cooling Method	Internal Fan
<b>COMMUNICATION</b>	
Embedded Interfaces	Rs485 / CAN / USB / Dry contact
External Modules ( Optional )	Wi-Fi / GPRS