



# MINECRAFT

21263



Q LEGO® Builder



[LEGO.com/sustainable-packaging](https://www.lego.com/sustainable-packaging)



FR  
**DONNEZ**  
OU  
**RECYCLEZ**



ASSOCIATION

OU



MAGASIN

OU



DÉCHÈTERIE

Adresses sur [quefairedemesdechets.fr](https://www.quefairedemesdechets.fr)

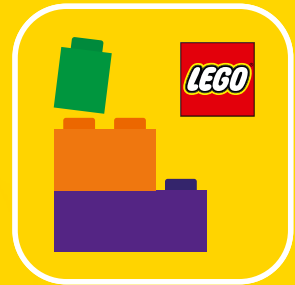

🔍 LEGO® Builder

# BUILDER

Download on the  
**App Store**

GET IT ON  
**Google Play**

**腾讯应用宝**  
安卓应用商店

Apple and the Apple logo are trademarks of Apple Inc., registered in the U.S. and other countries and regions. App Store is a service mark of Apple Inc. Google Play and the Google Play logo are trademarks of Google LLC. Tencent and the Tencent logo are trademarks of Tencent Inc.

🔍 [LEGO.com/devicecheck](https://LEGO.com/devicecheck)

**EN** Ask parents' permission before going online | **DE** Eltern um Erlaubnis bitten, bevor du online gehst | **FR** Demande l'autorisation d'un parent avant d'aller en ligne | **IT** Chiedi il permesso ai tuoi genitori prima di andare online | **ES** Pídeles permiso a tus papás antes de conectarte a Internet | **PT** Pede autorização aos pais antes de acederes online | **ZH** 上网前应先征得父母的同意 | **PL** Poproś rodziców o zgodę, zanim wejdiesz do Internetu | **CS** Než půjdeš na internet, požádej rodiče o svolení | **SK** Skôr než pôjdeš na internet, vypýtaj si povolenie od rodičov | **HU** Kérj szülői engedélyt, mielőtt online csatlakoznál! | **RO** Cere permisiunea părinților înainte de a te conecta online | **BG** Поискайте разрешение от родител, преди да влезете онлайн | **LV** Pirms došanās tiešsaistē palūdz atļauju vecākiem | **ET** Enne Interneti kasutamist küsi vanematelt luba | **LT** Prieš prisijungdami prie interneto, atsklauskite tėvų

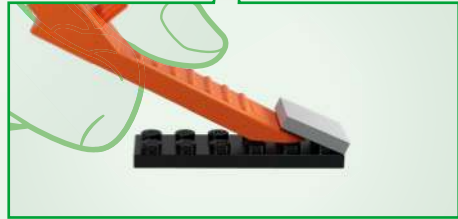
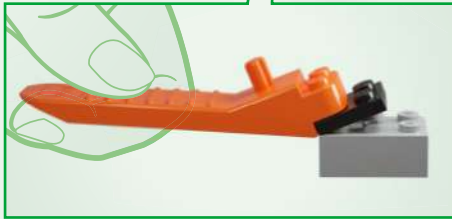
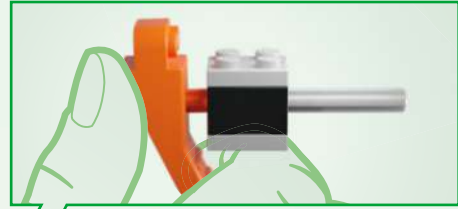

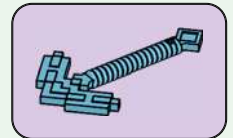
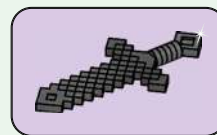
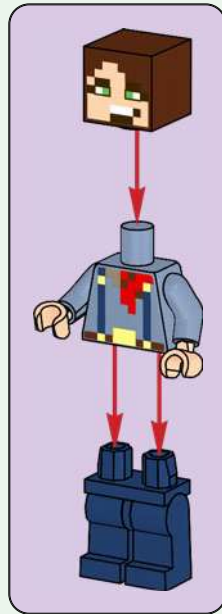

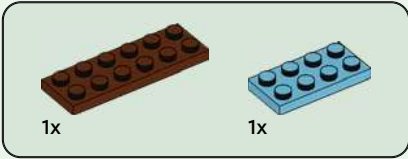

1

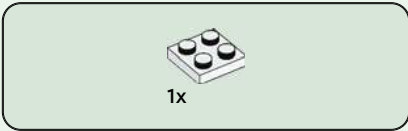
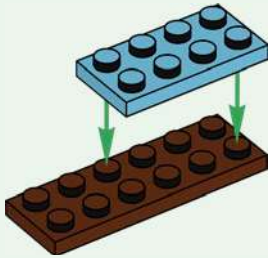

2

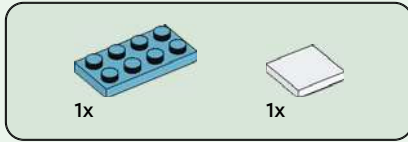

3

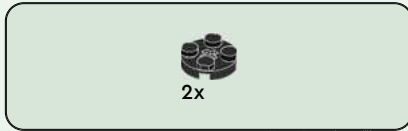
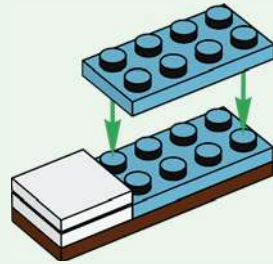

4

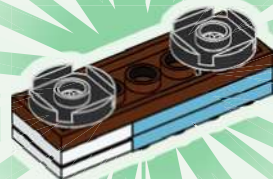



2x



2x



2x



2x



2x



2x



4x

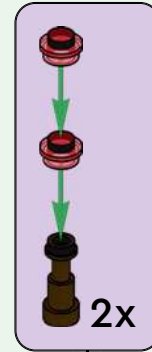

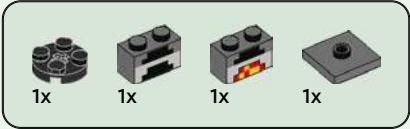

1



2

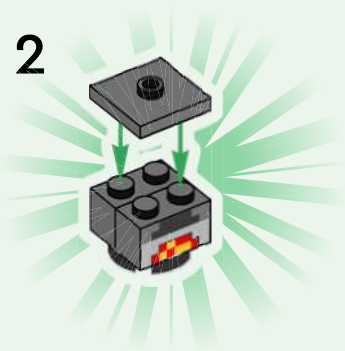



1



2

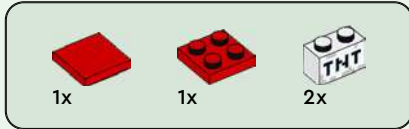

1

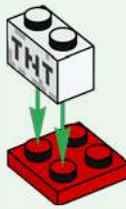

2

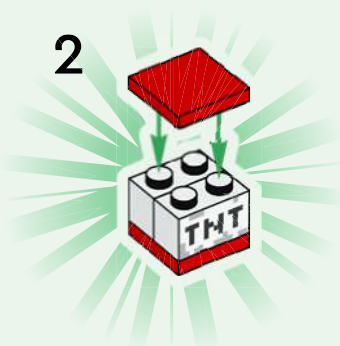

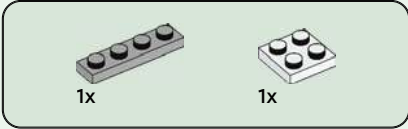

1

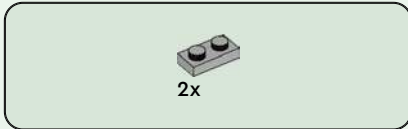
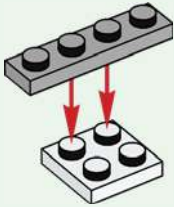

2

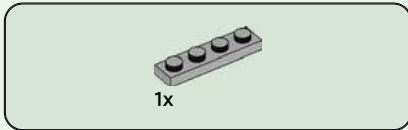
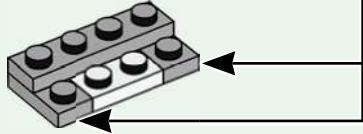
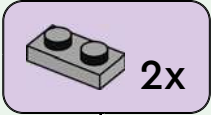

3

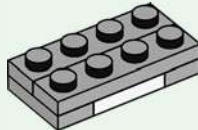

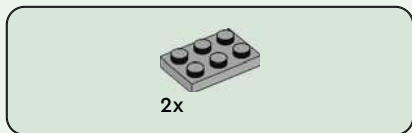

4

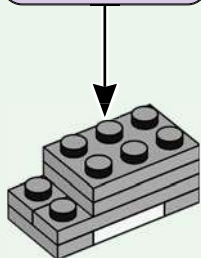
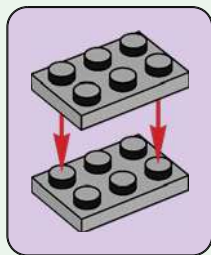

5

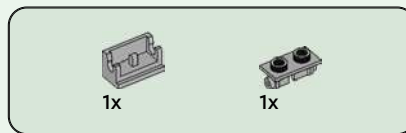
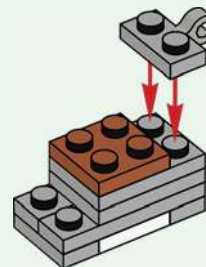

6

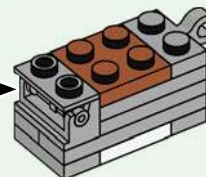
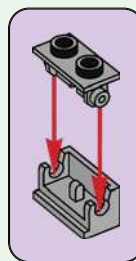

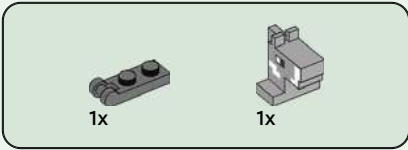

7

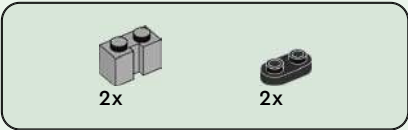
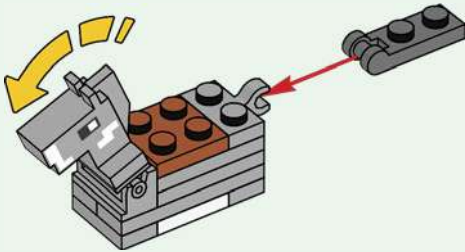

8

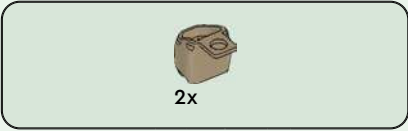
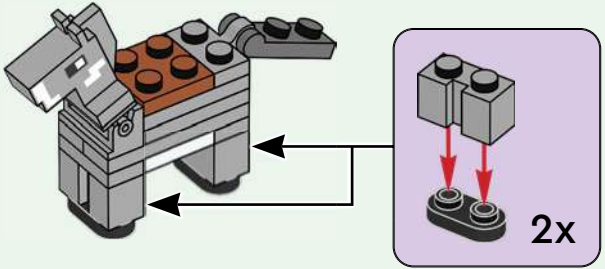

9

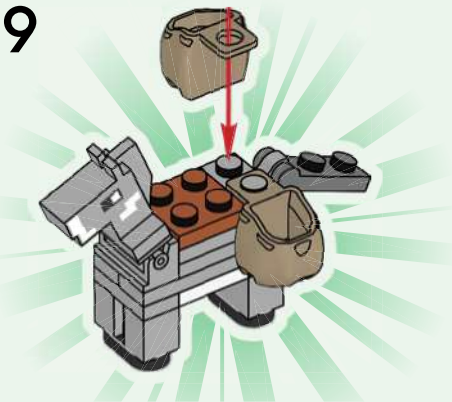

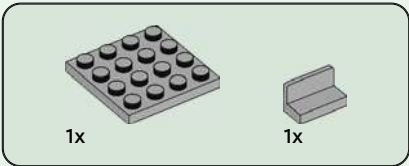

1

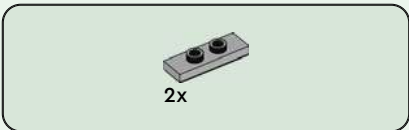
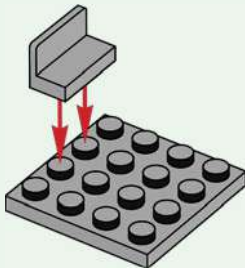

2

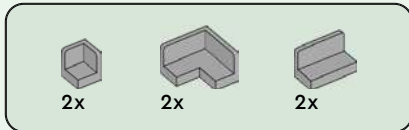
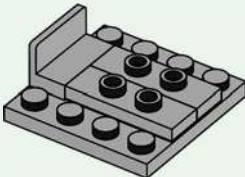

3

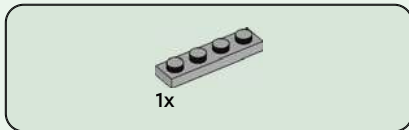
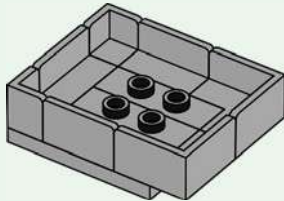

4

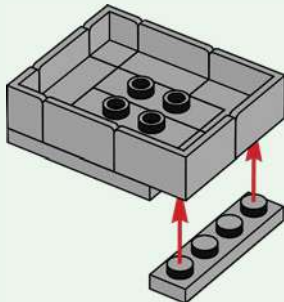

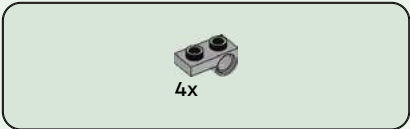

5

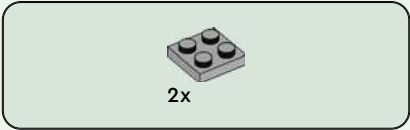
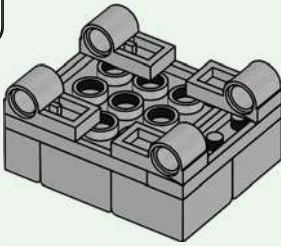

6

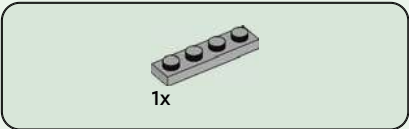
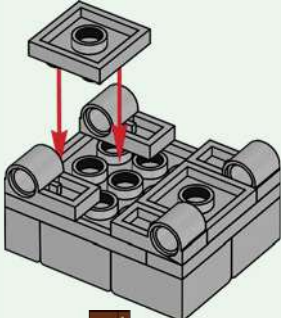

7

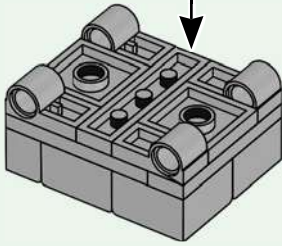
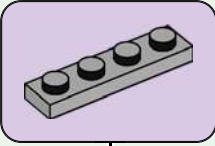

8

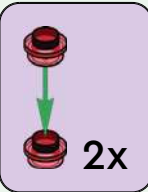
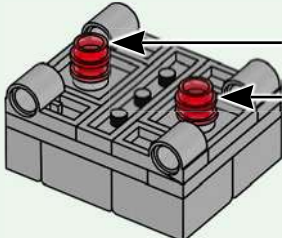

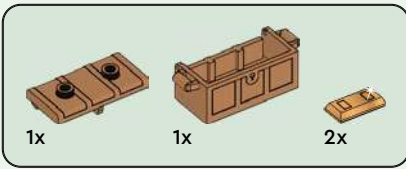

9

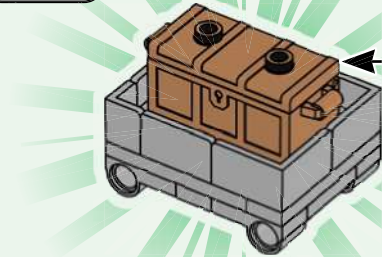
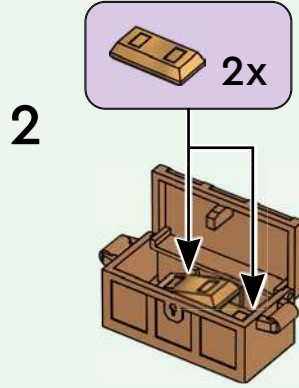
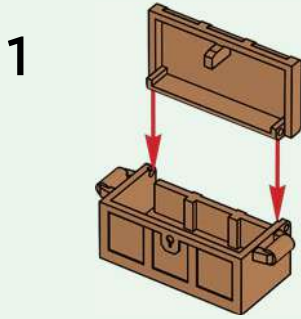

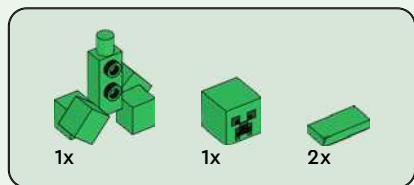

1

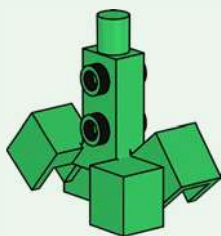

2

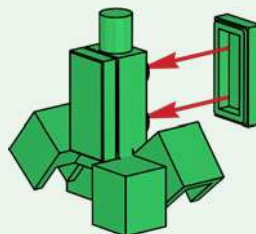

3

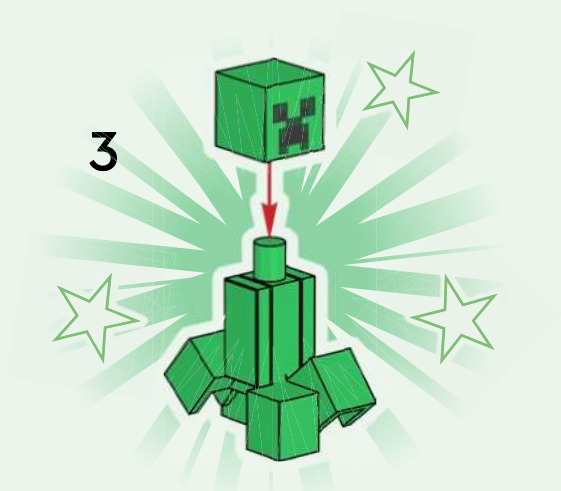

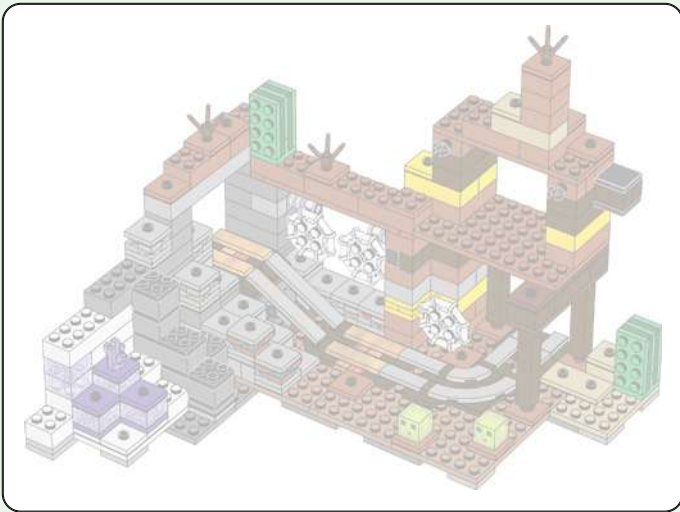

2

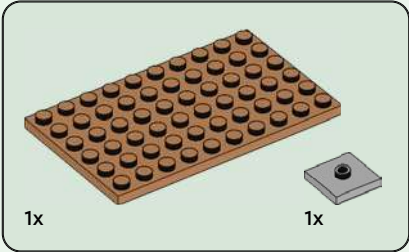

1

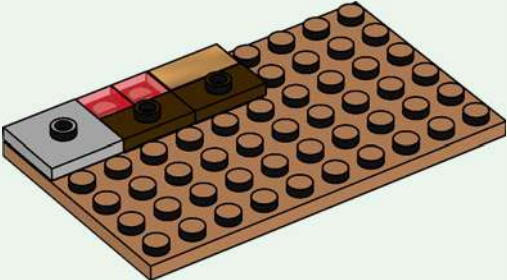
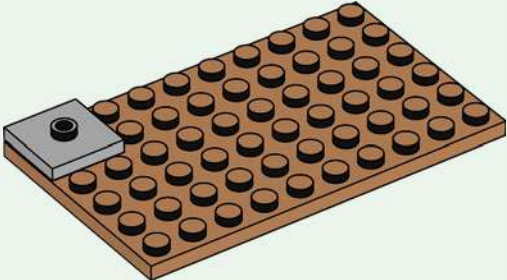



2x

3

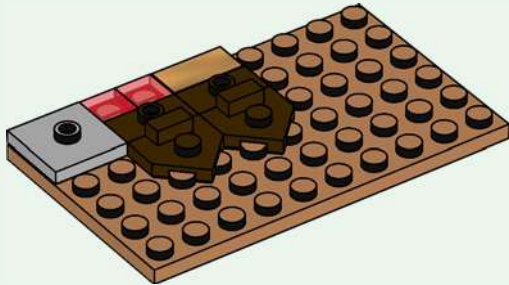

3x

4

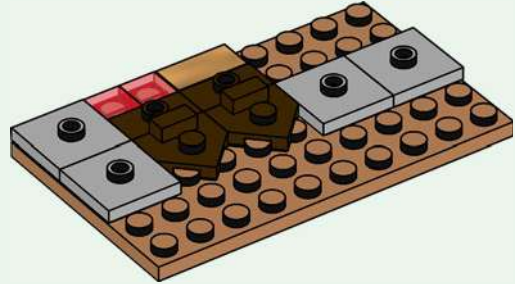

3x

5

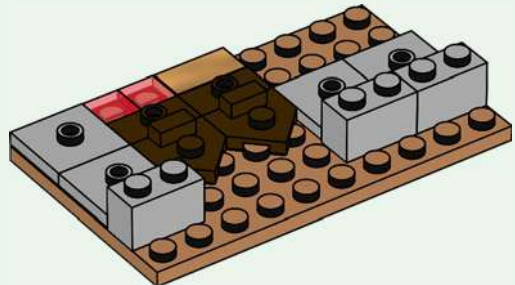

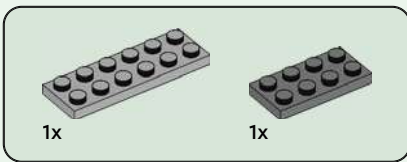

6

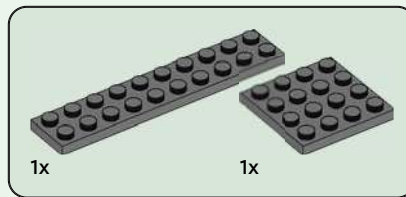
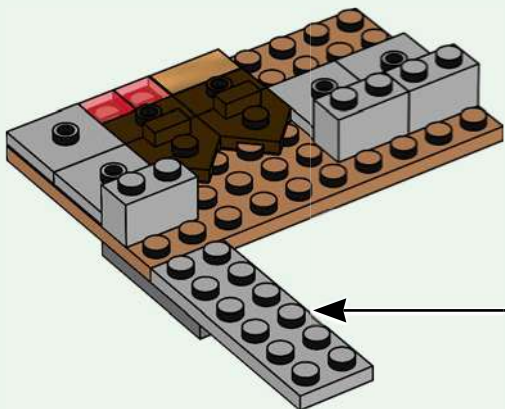
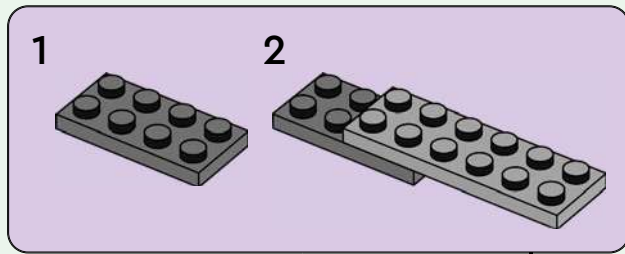

7

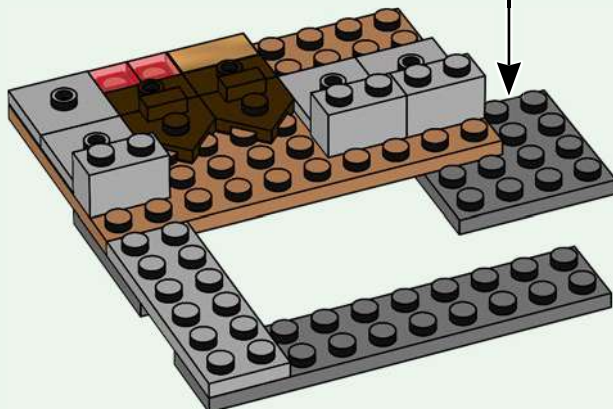
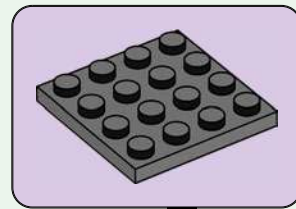

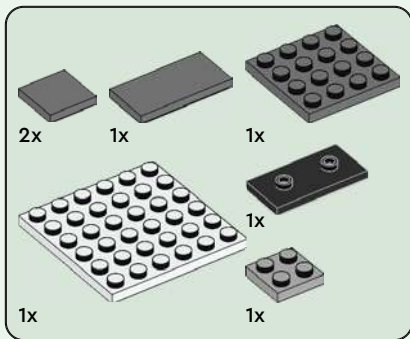

8

1

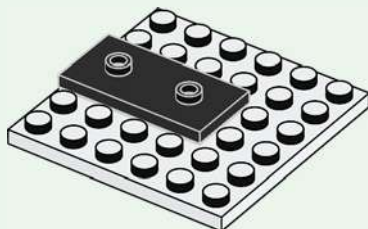

2

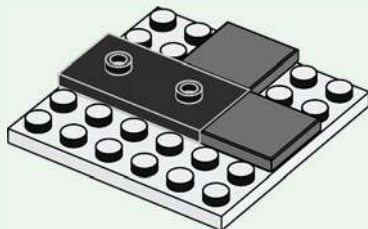

3

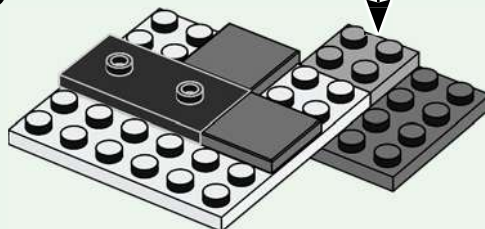

4

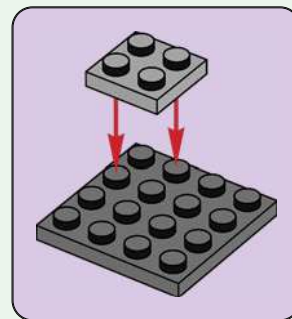
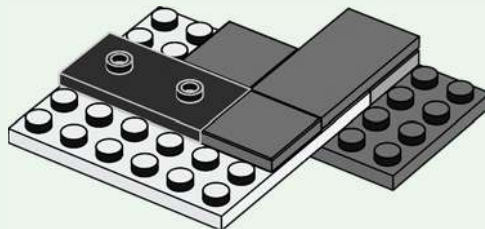

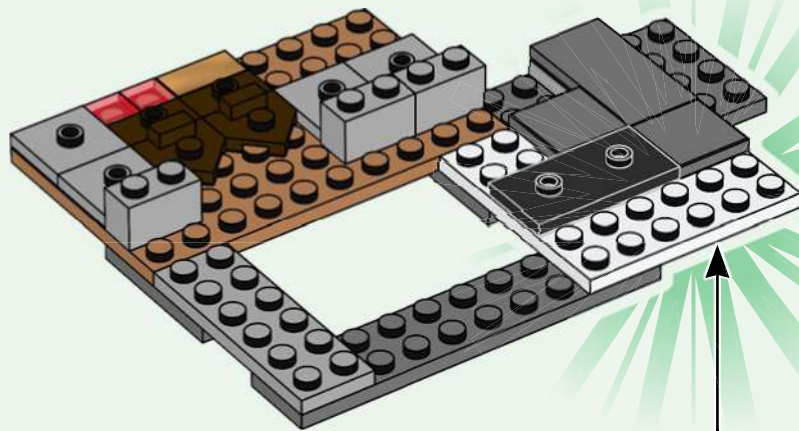

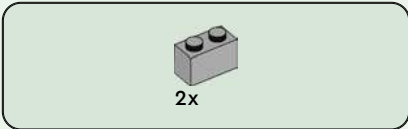

9

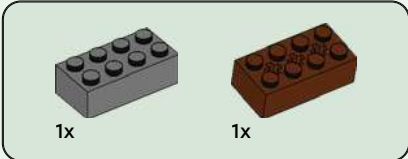
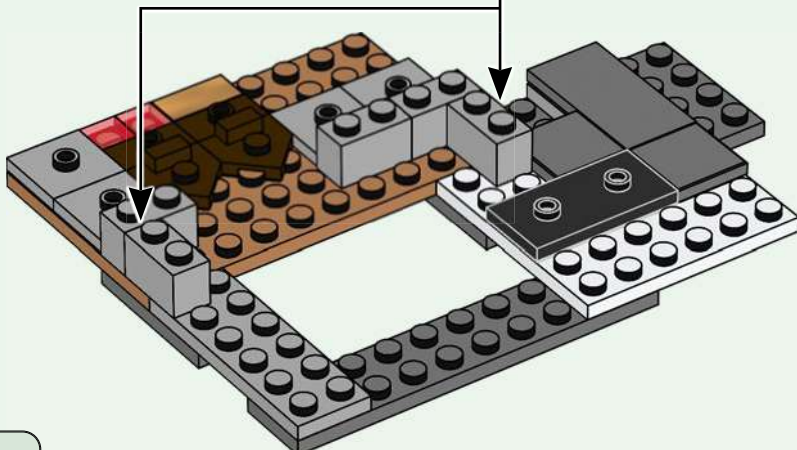
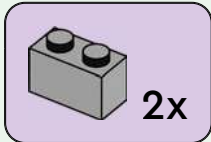

10

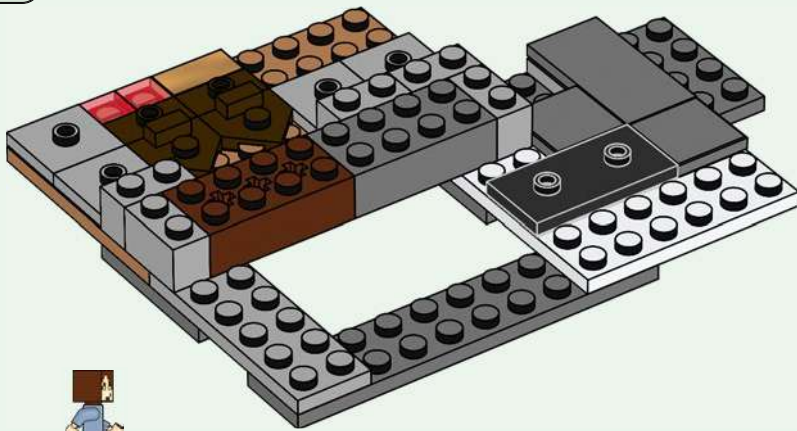

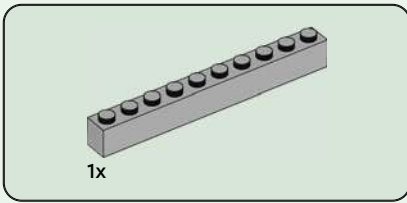

11

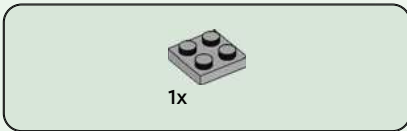
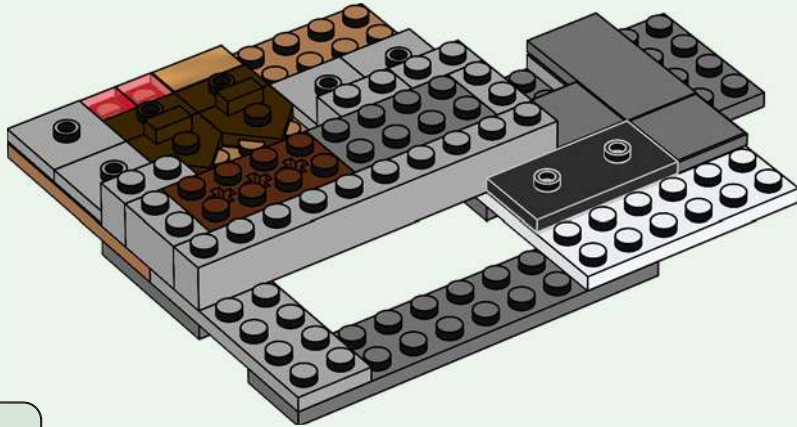

12

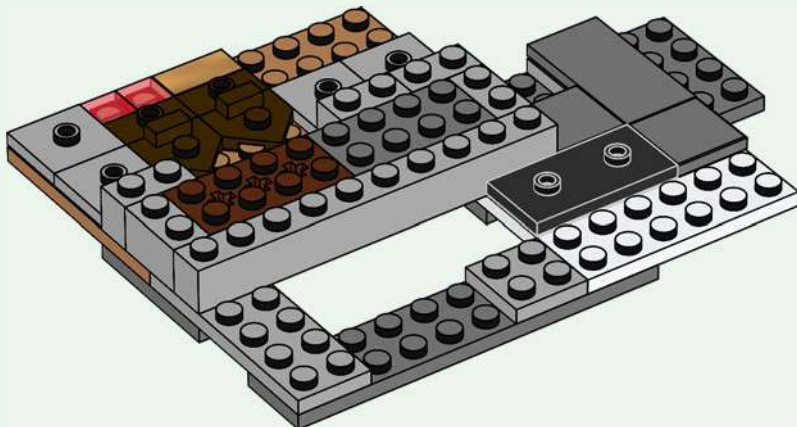

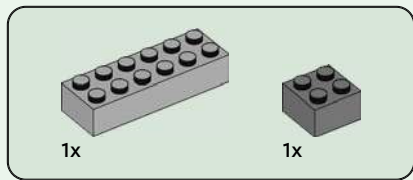

13

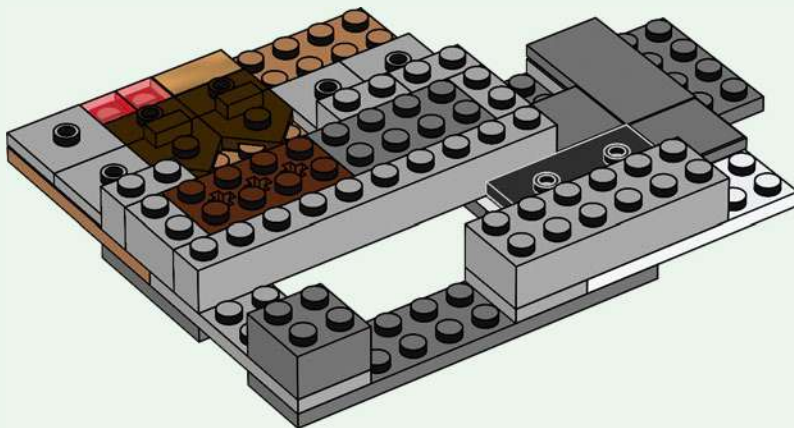

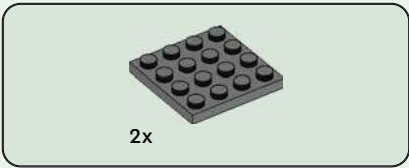

14

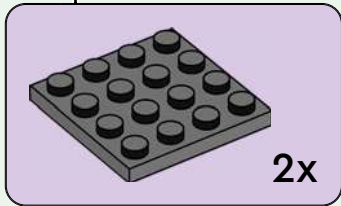
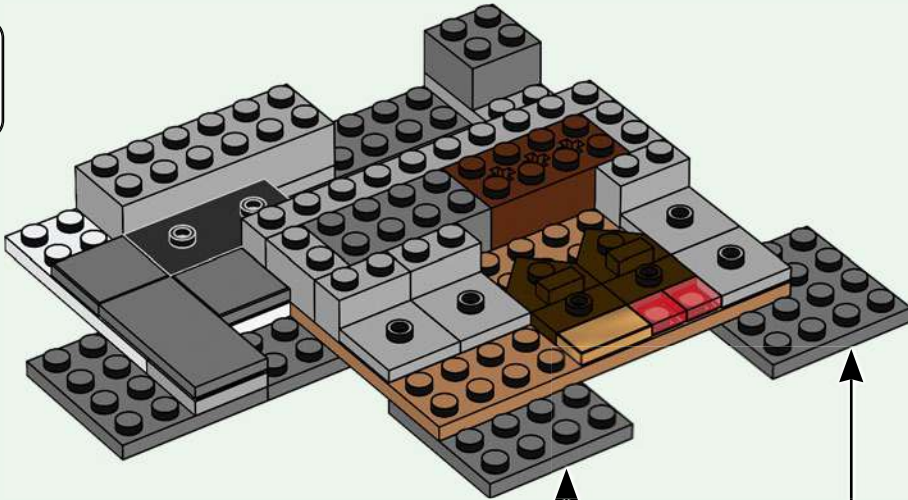

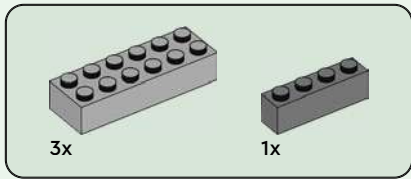

15

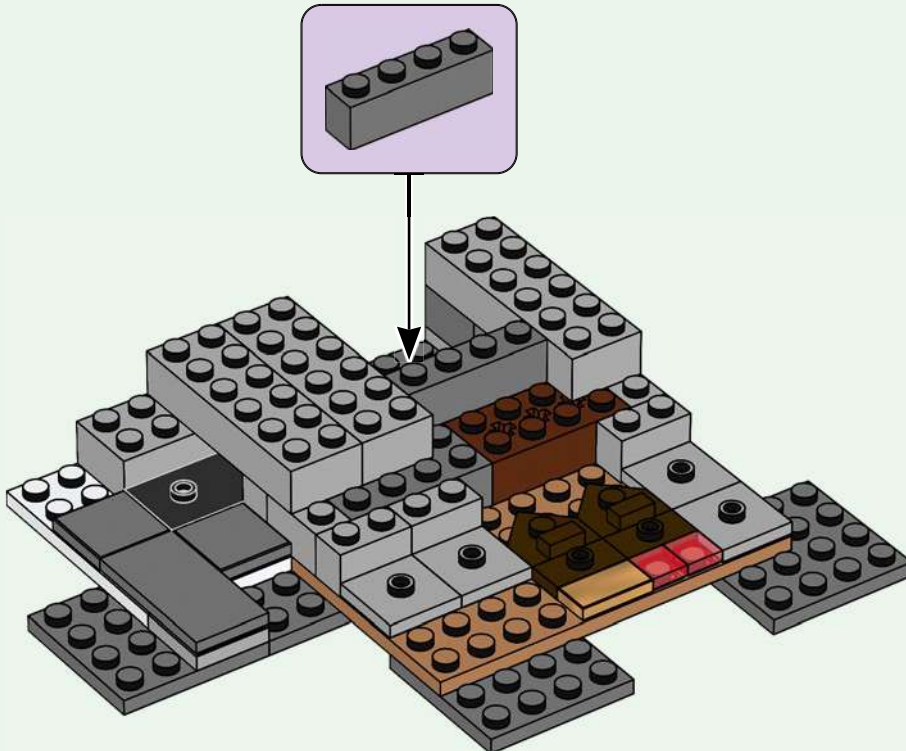

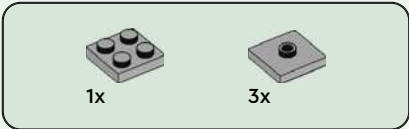

16

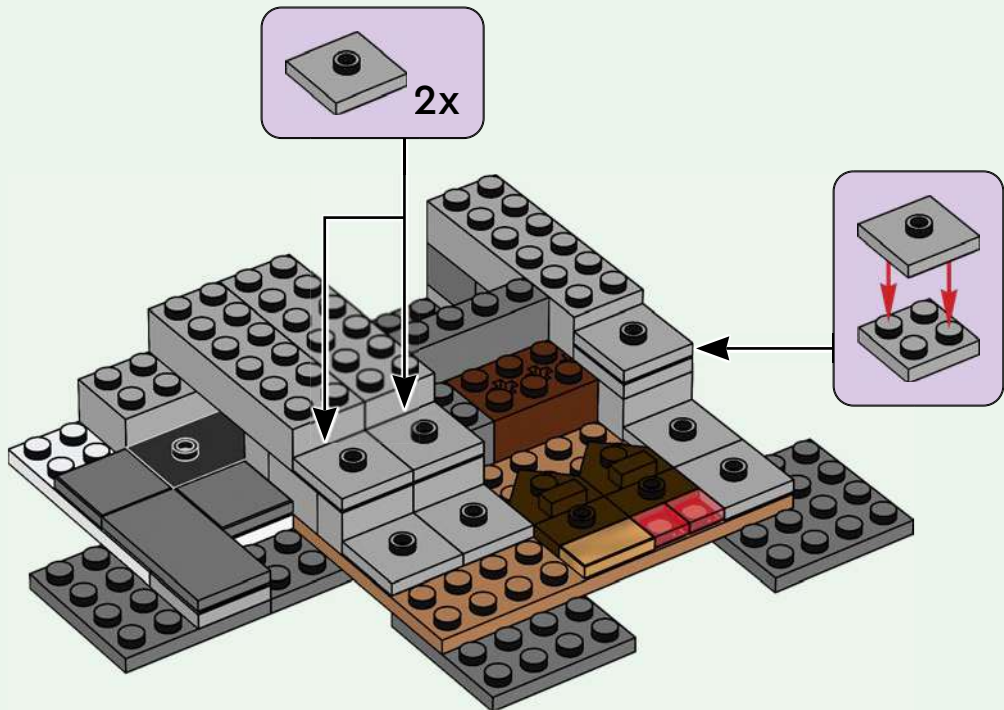

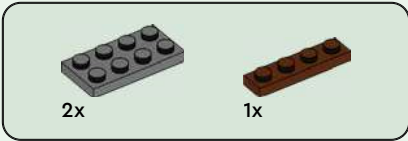

17

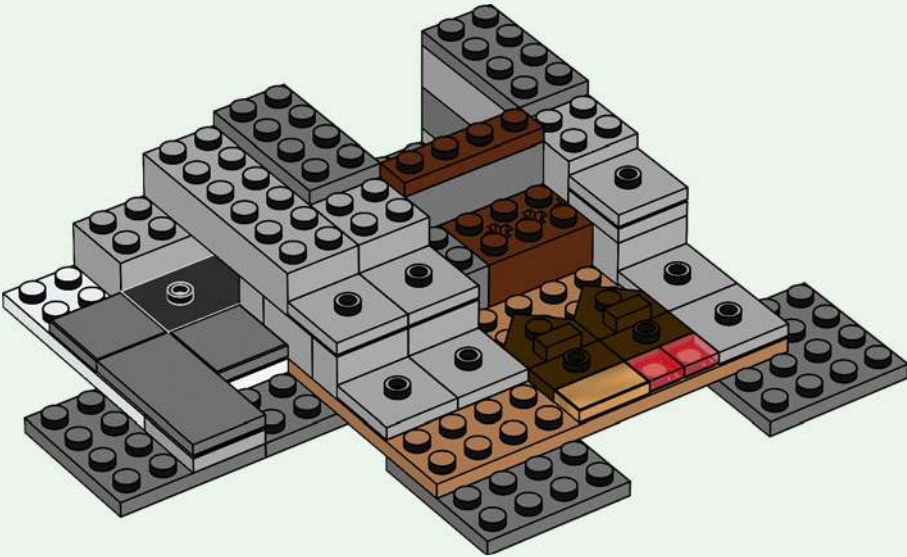

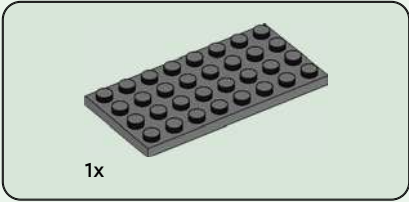
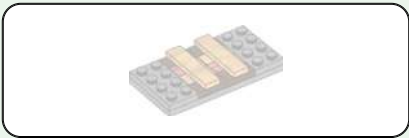

18

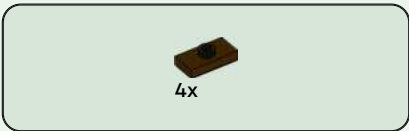
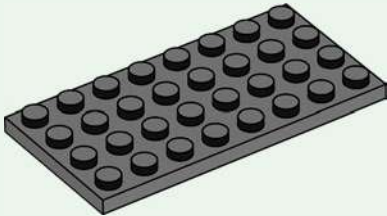

19

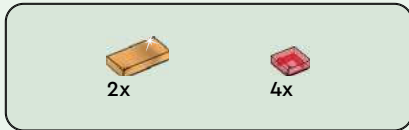
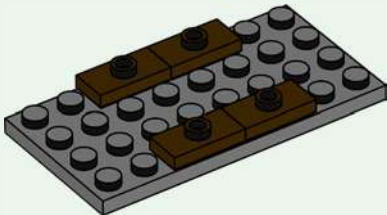

20

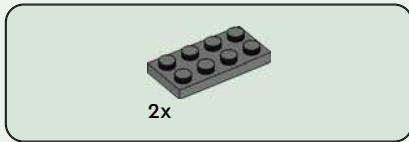
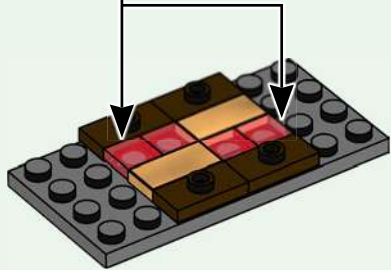

21

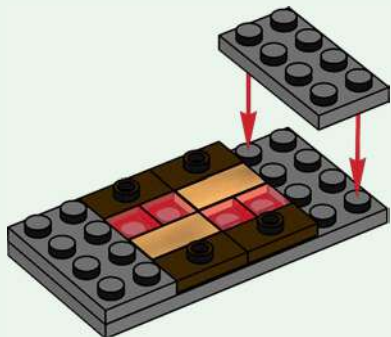



2x

22

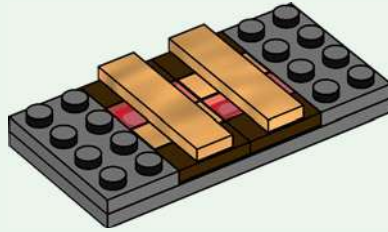

23

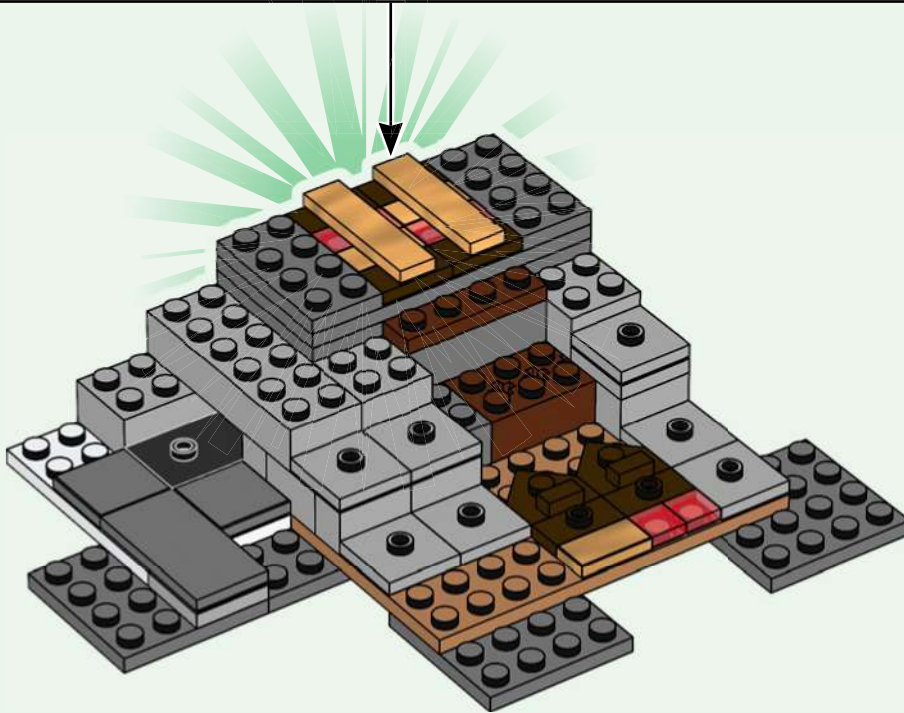



3x

24

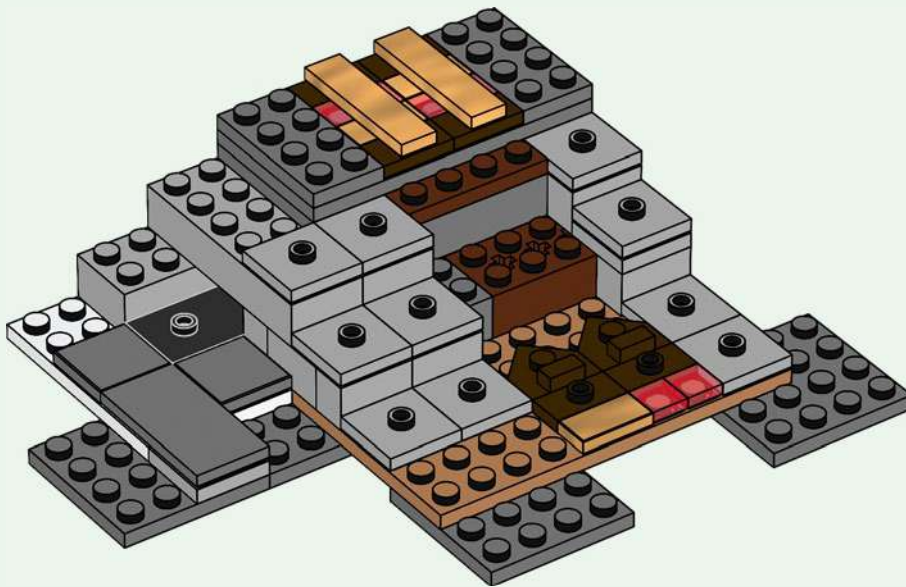

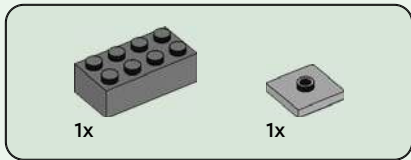

25

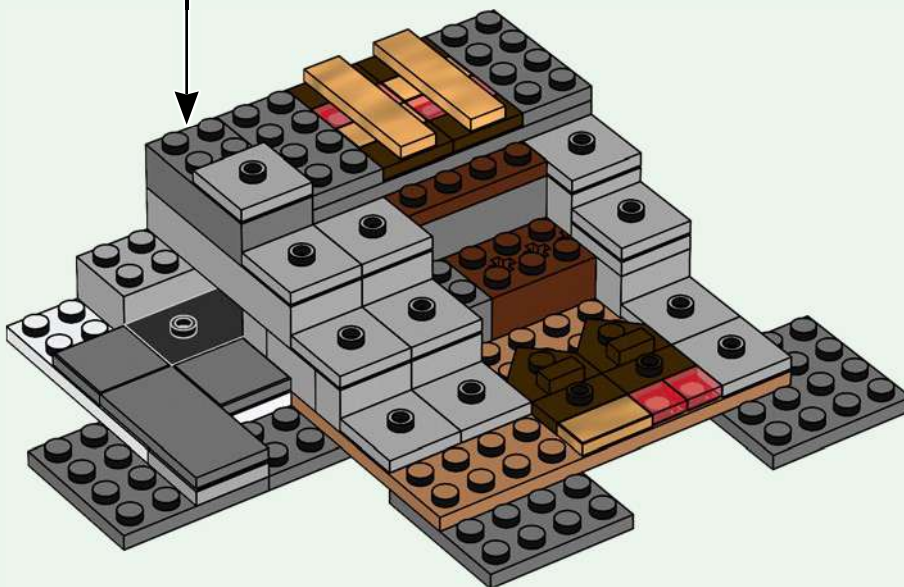
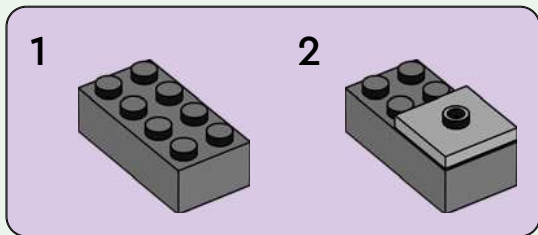

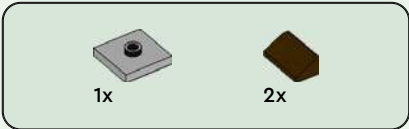

26

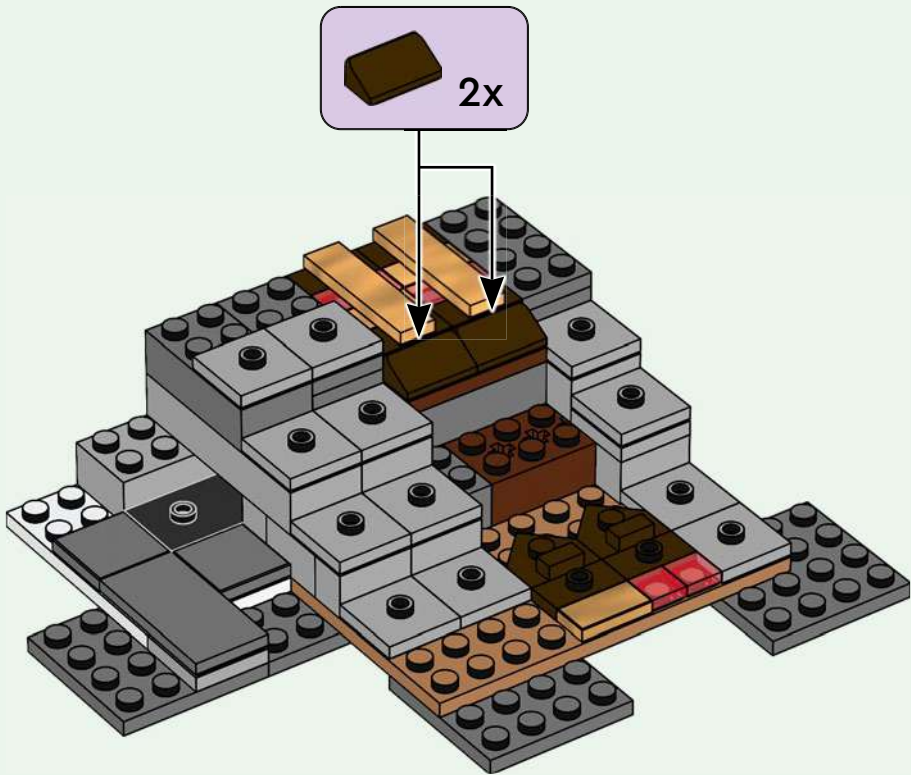

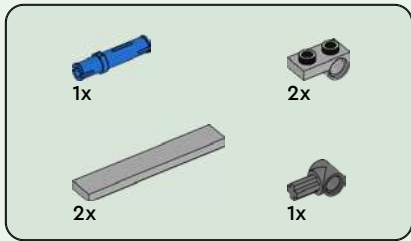

27

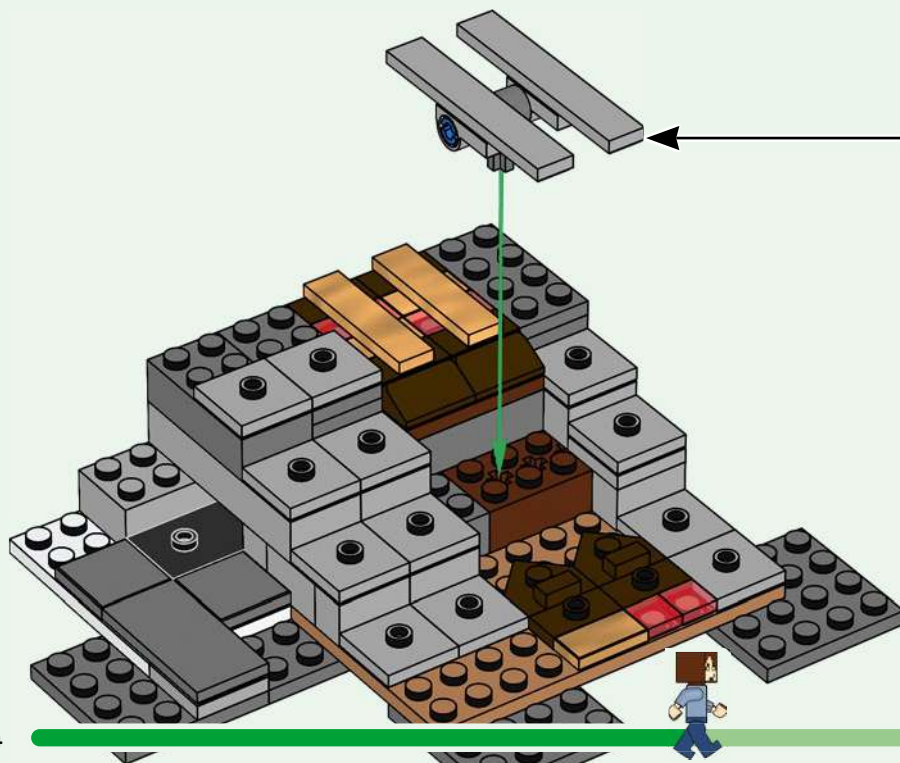
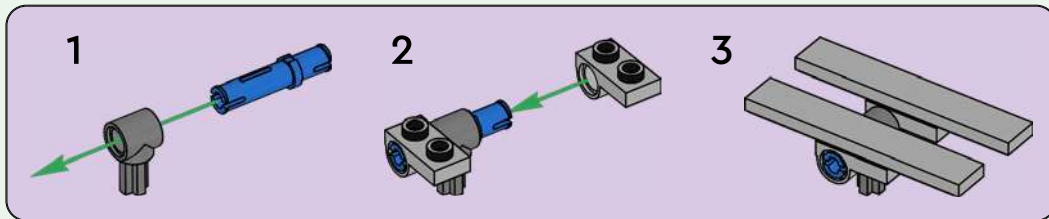

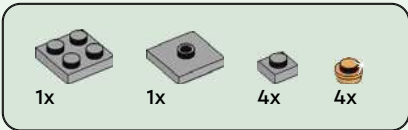

28

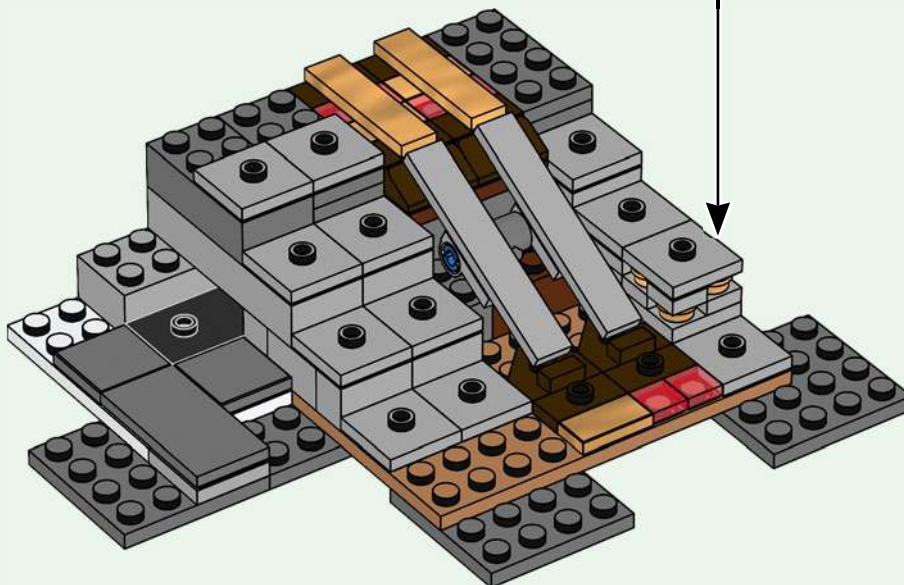
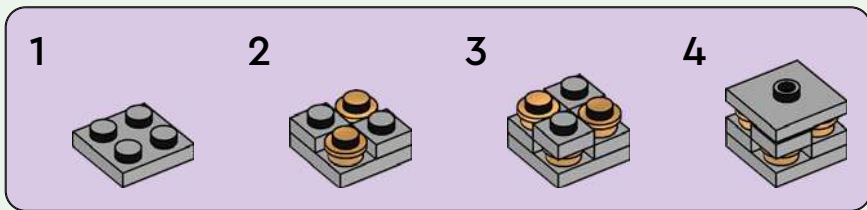

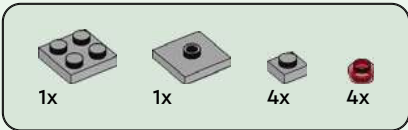

29

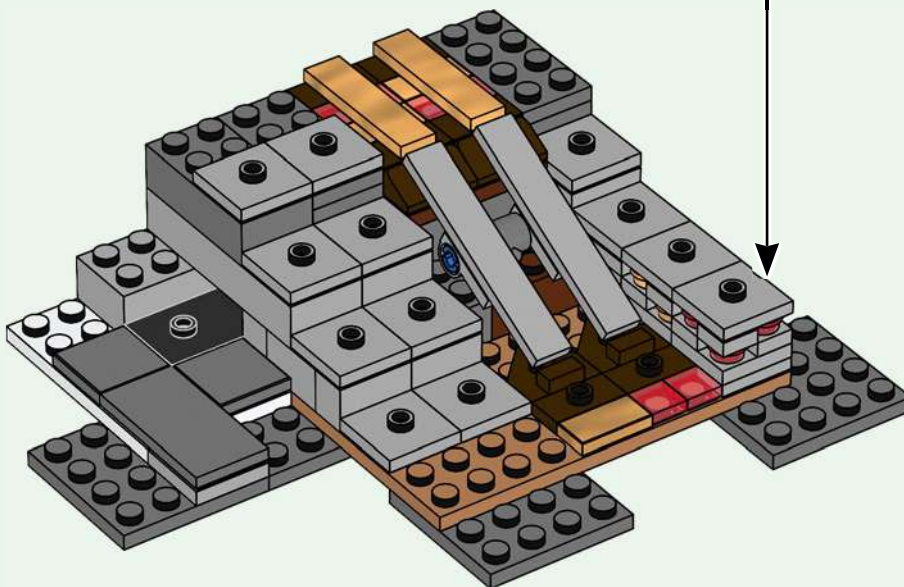
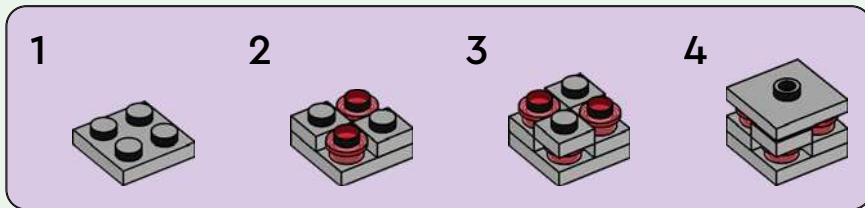



30

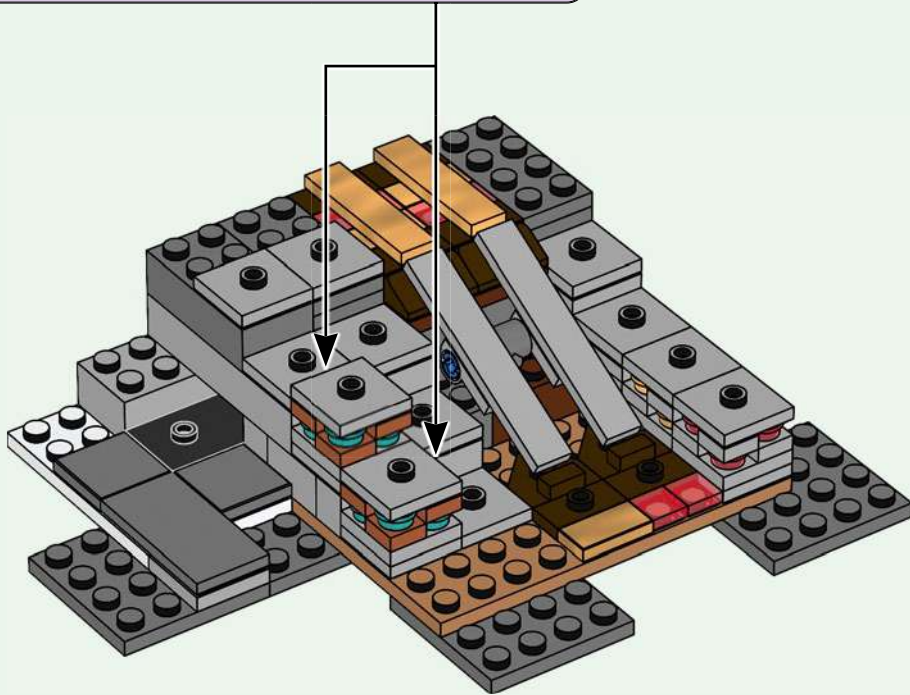
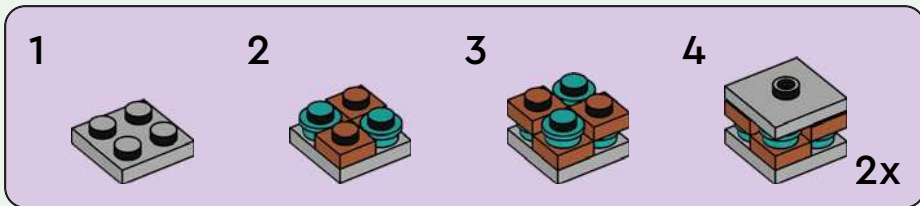

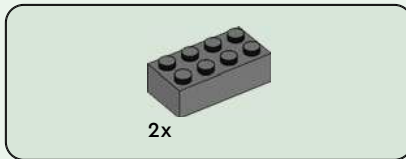
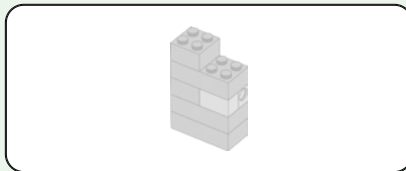

31

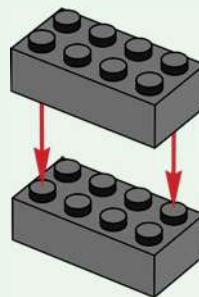

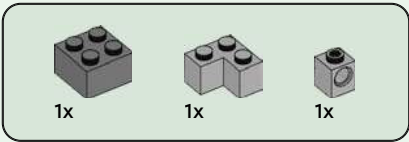

32

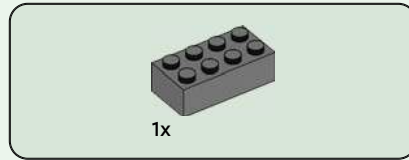
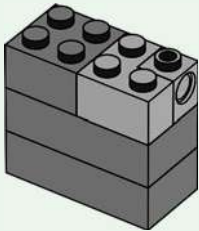

33

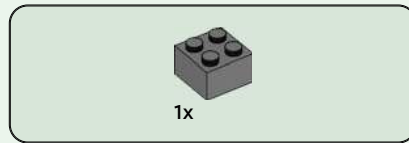
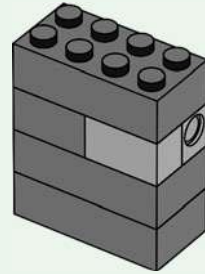

34

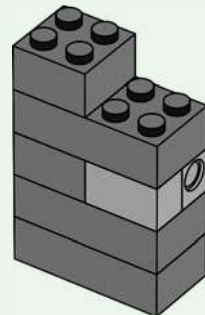

35

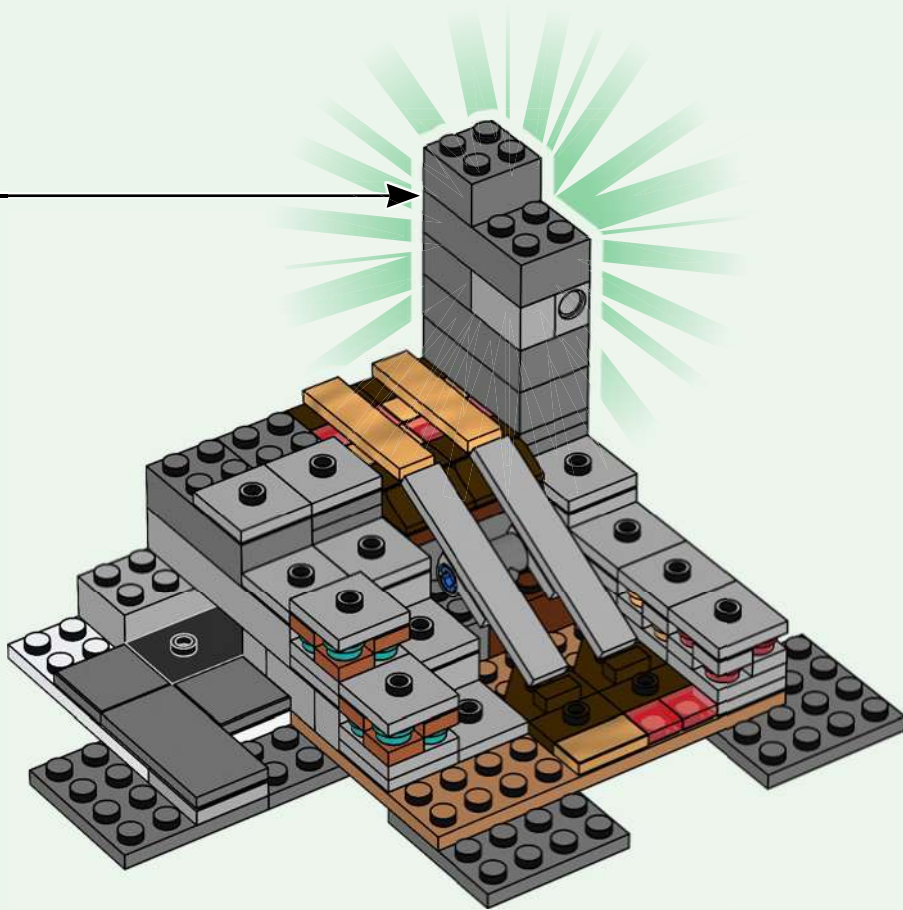

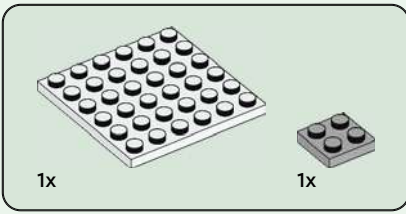

36

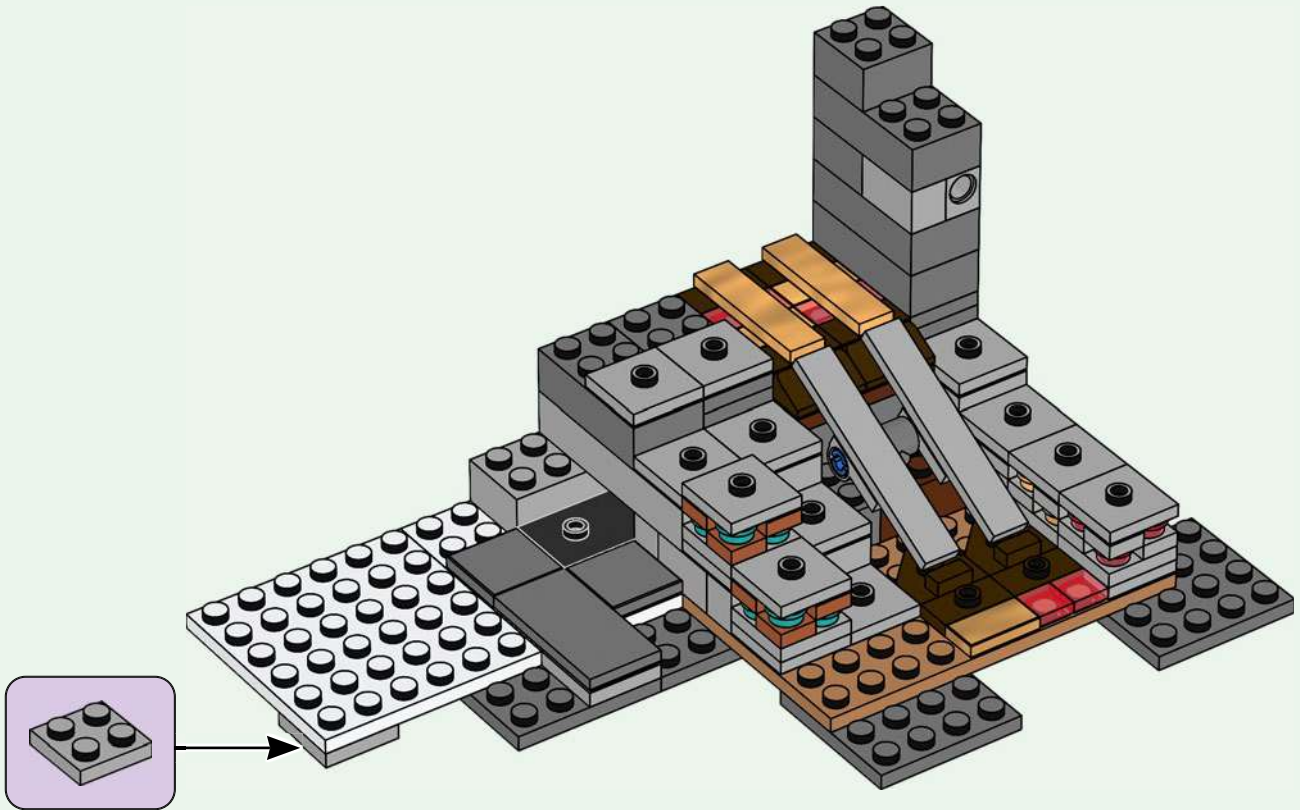

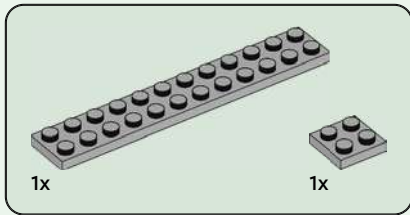

37

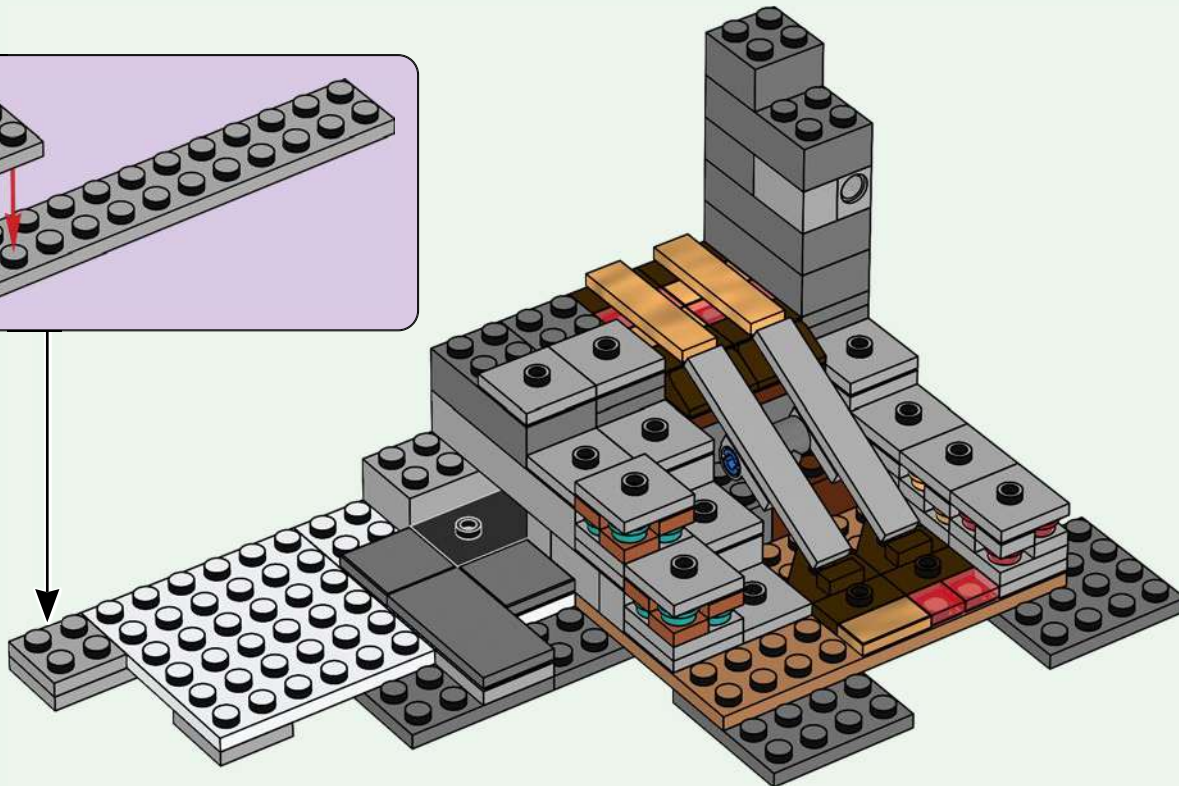
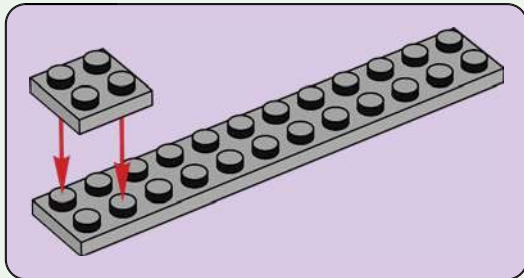



2x

38

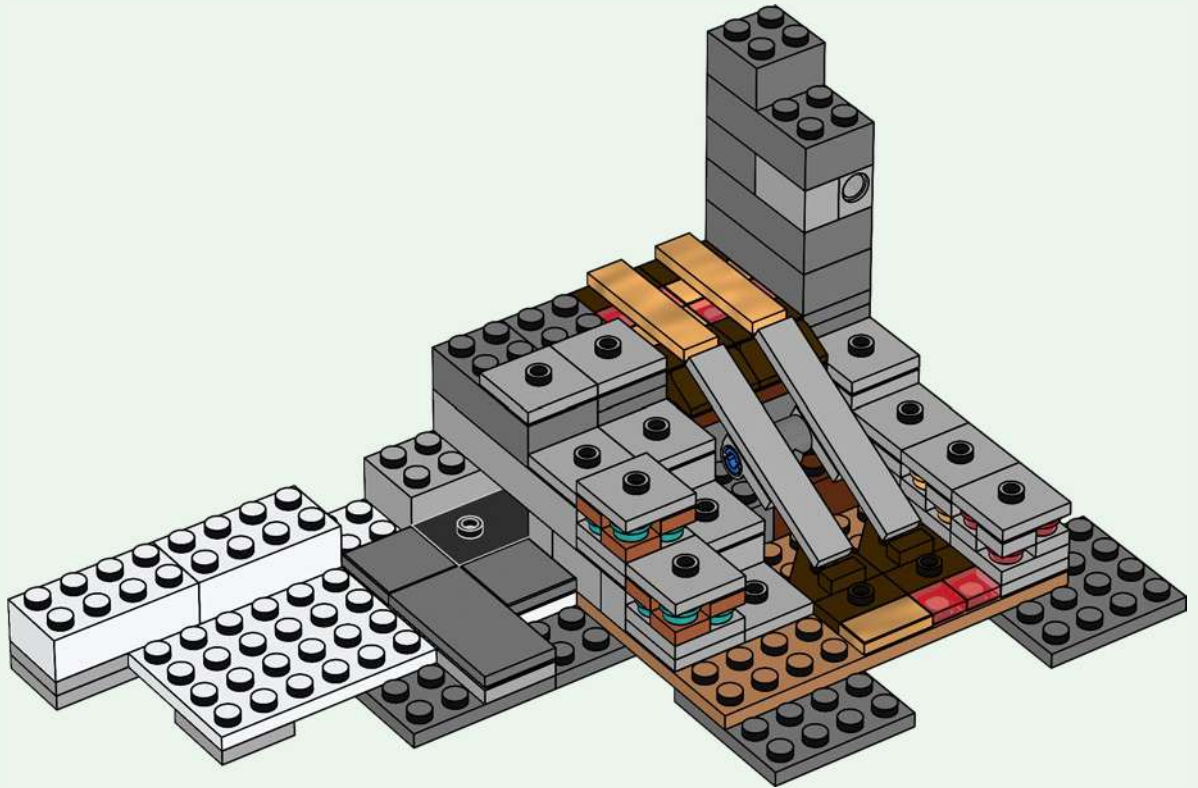



1x



1x

# 39

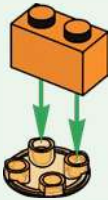

2x



2x

# 40

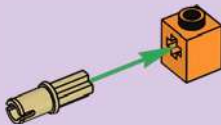

2x

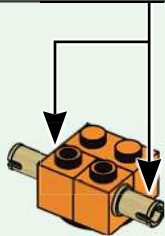

1x



1x

# 41

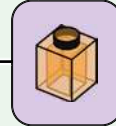

1x



1x

# 42

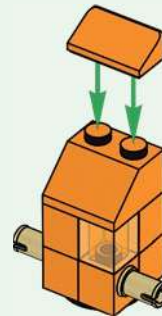



1x

# 43

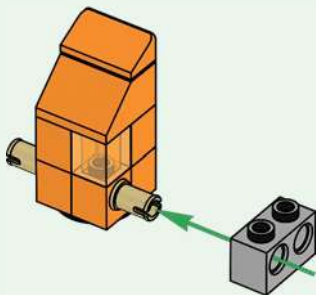

2x



1x



1x



1x

# 44

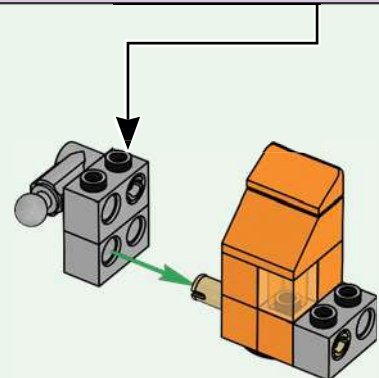
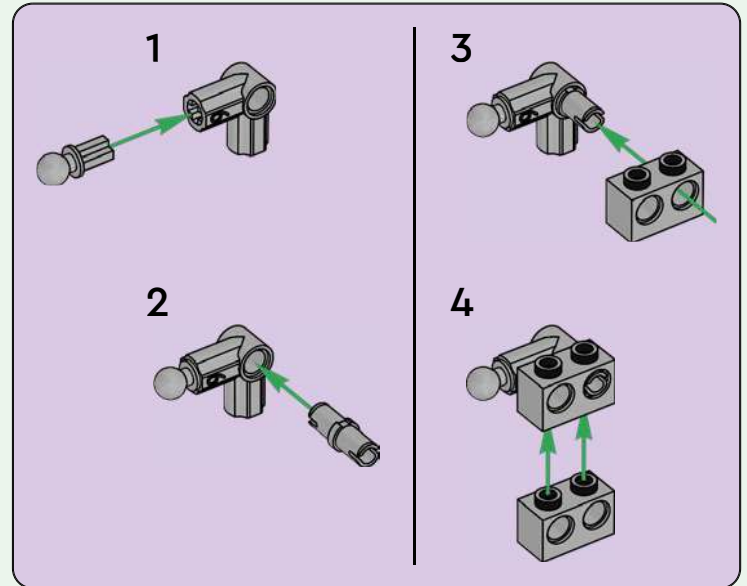

45

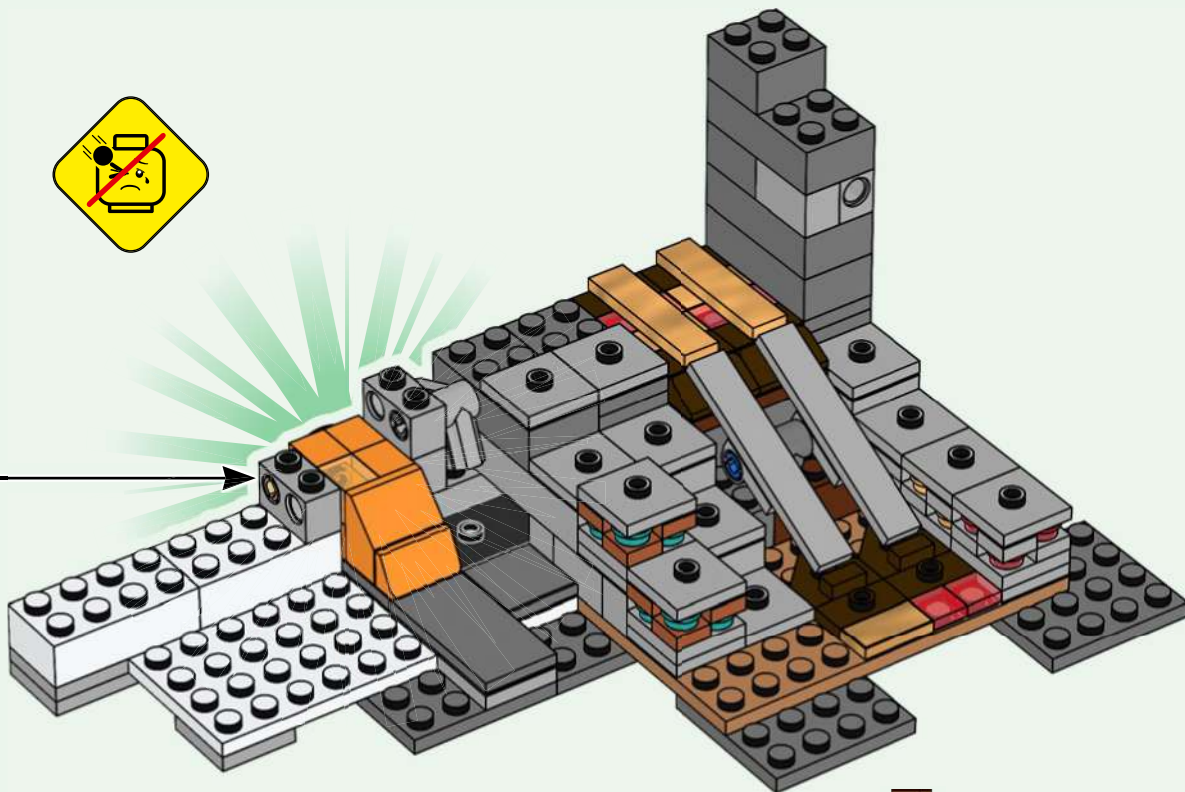

46



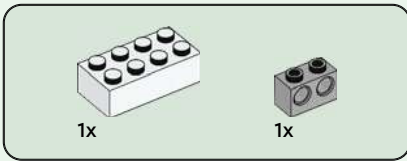

46

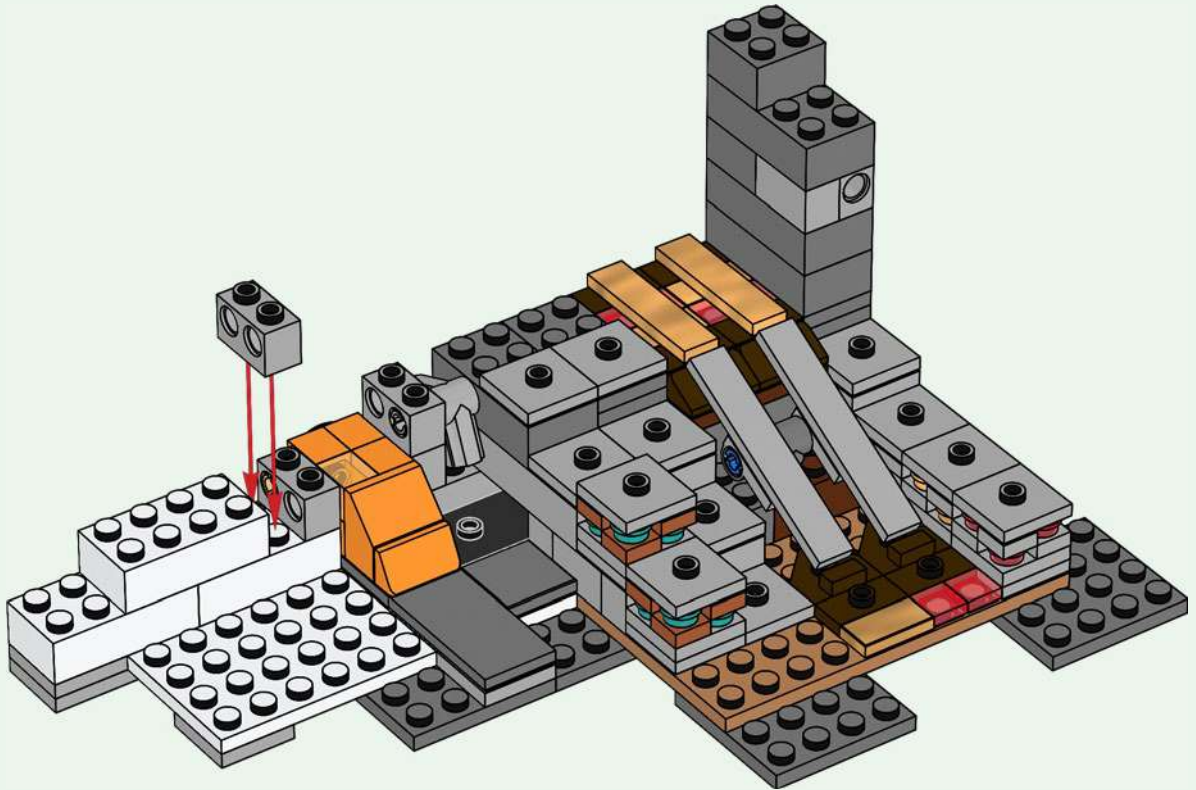

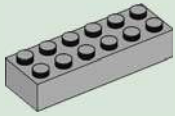

1x

47

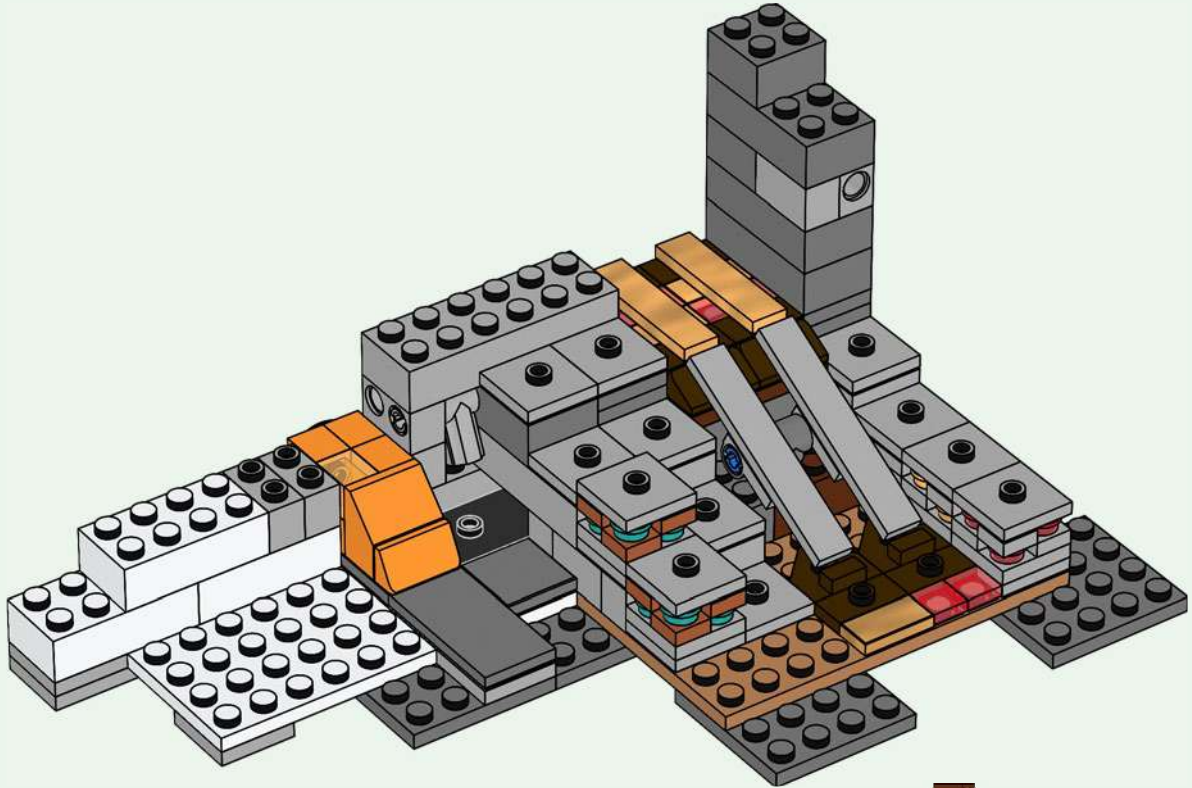

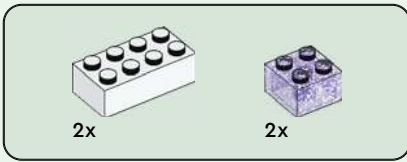

48

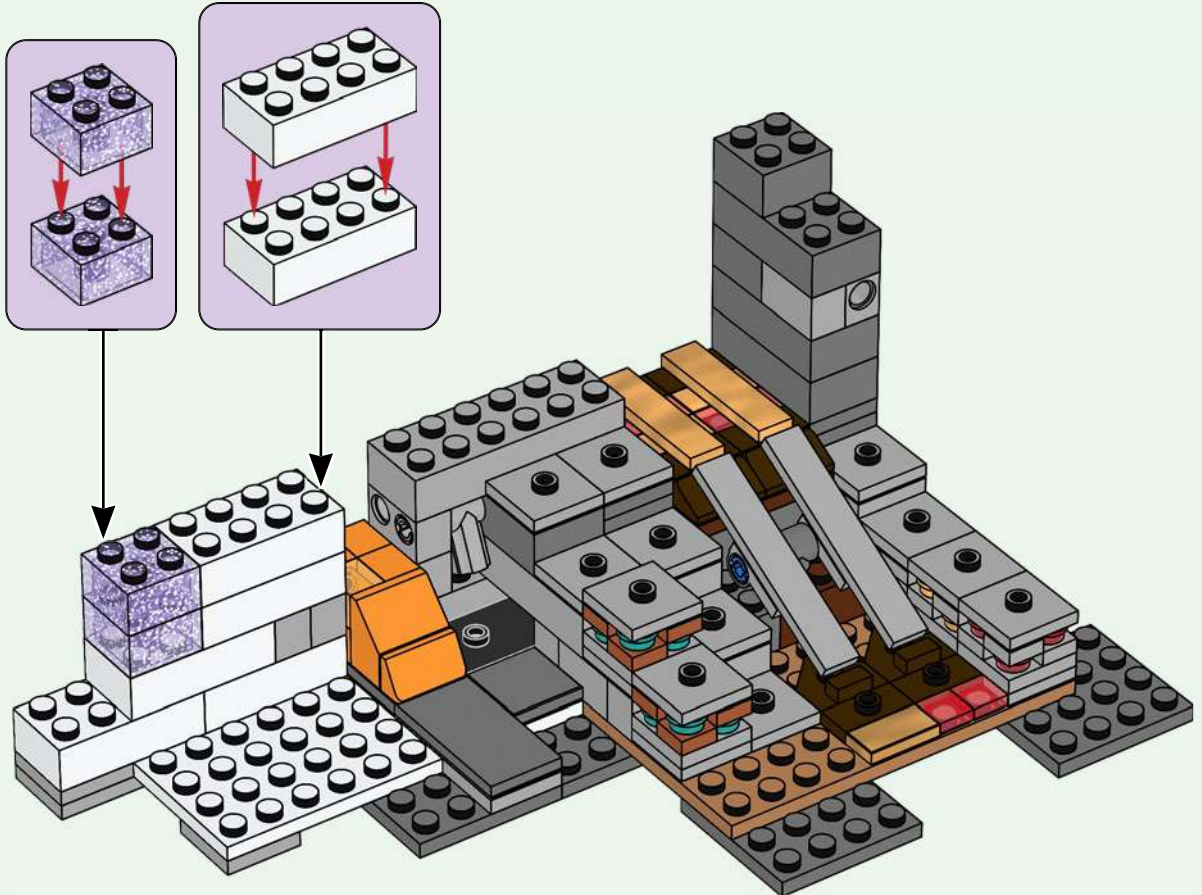

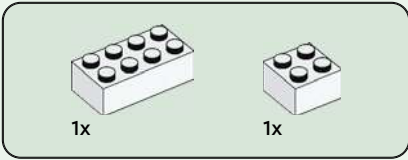

49

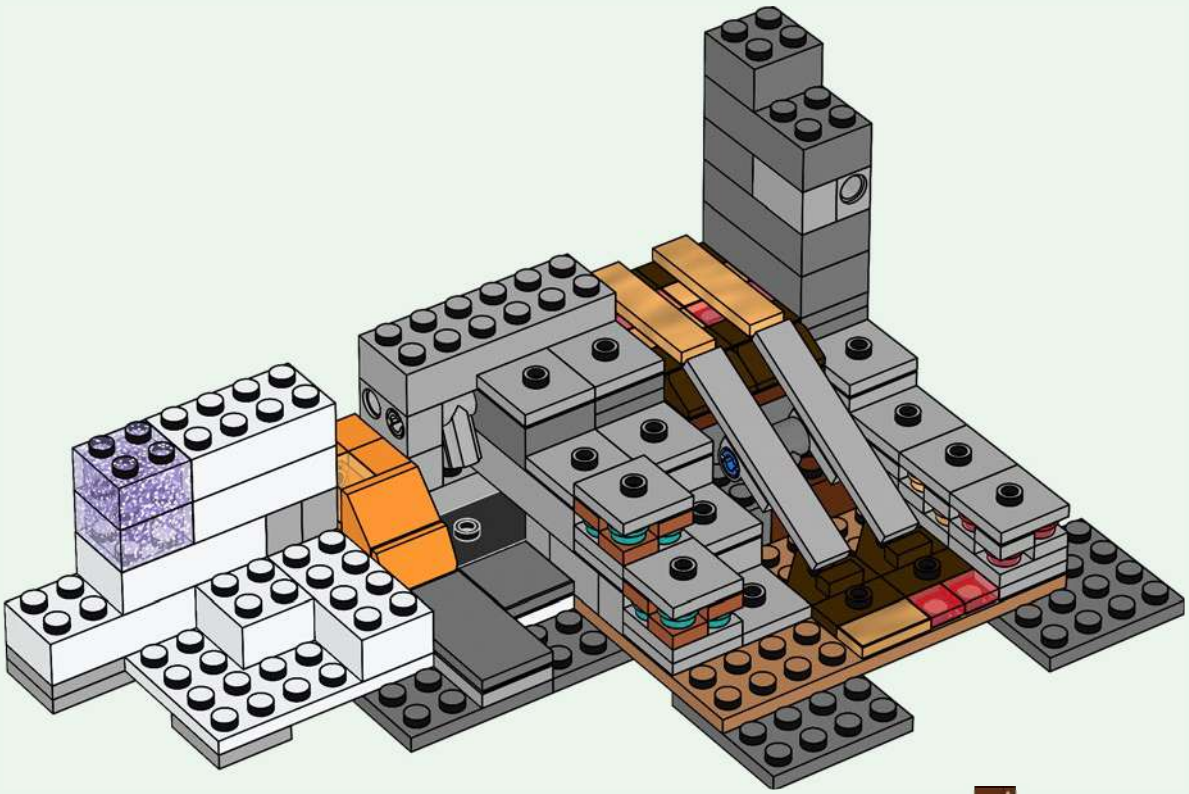



1x

50

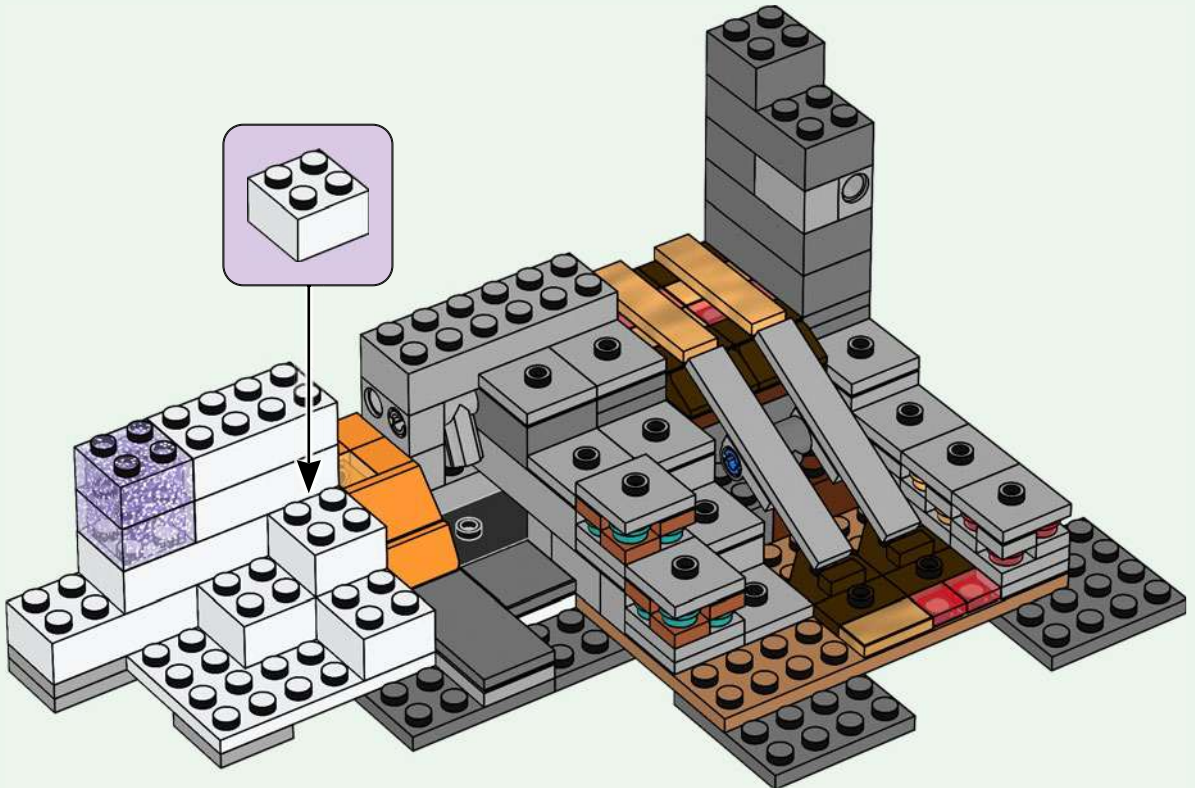



4x

51

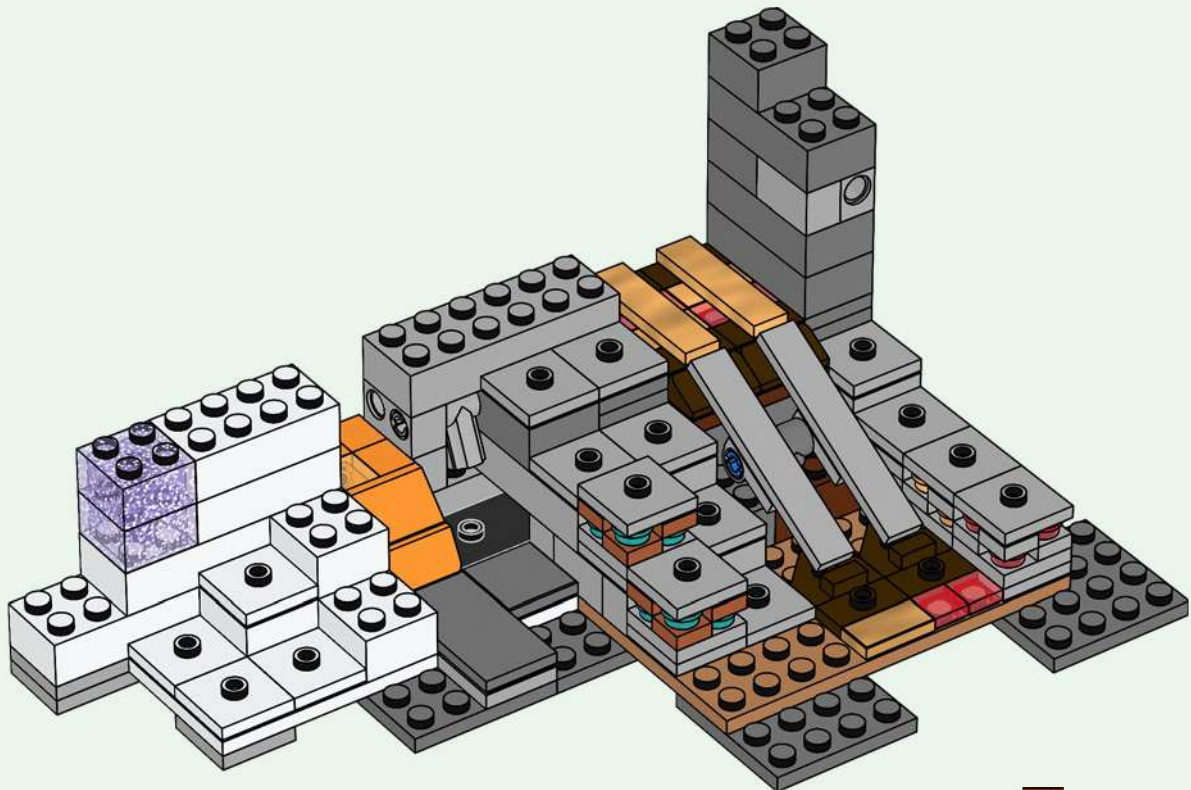

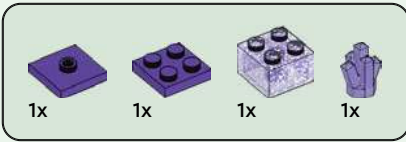

52

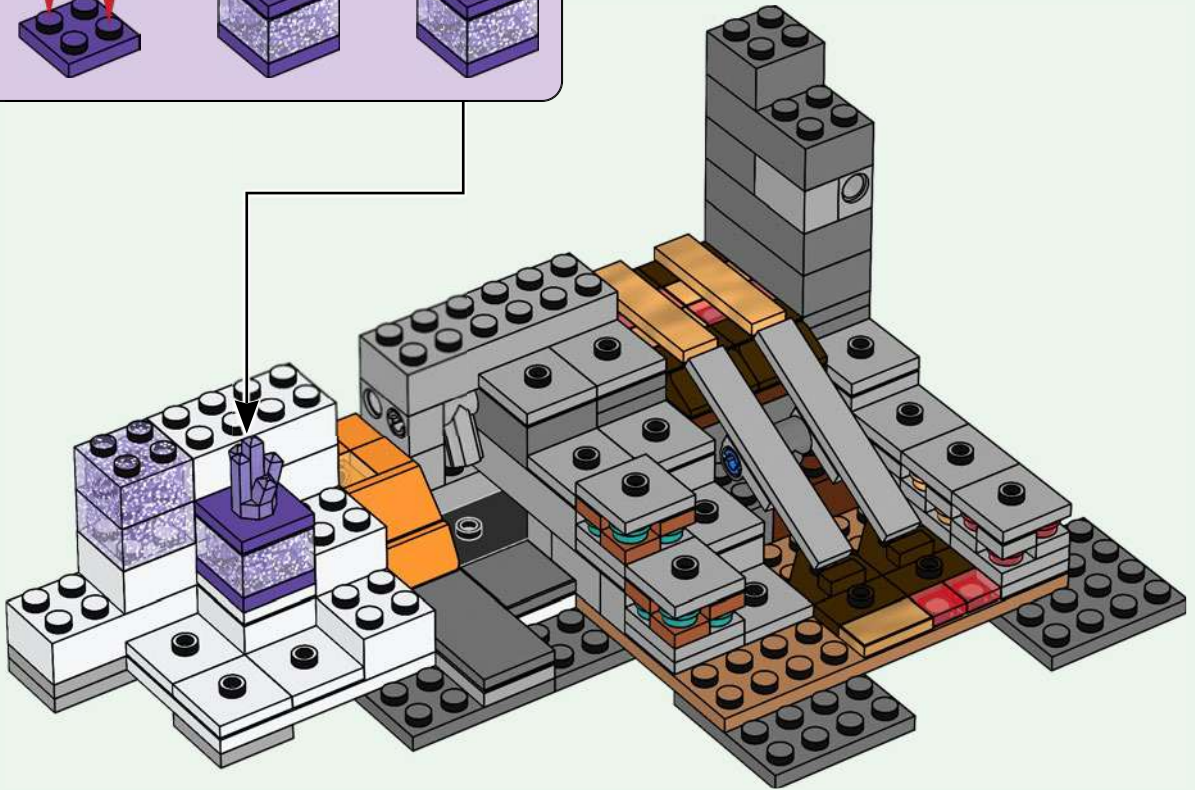
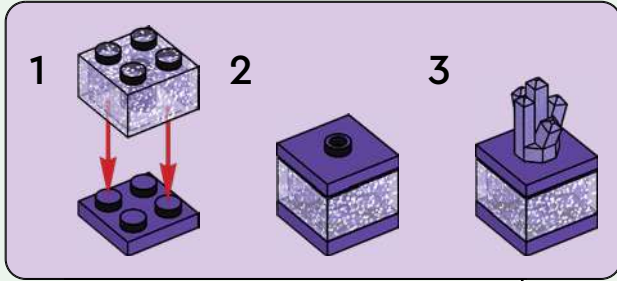

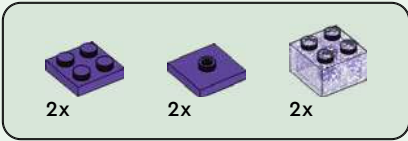

53

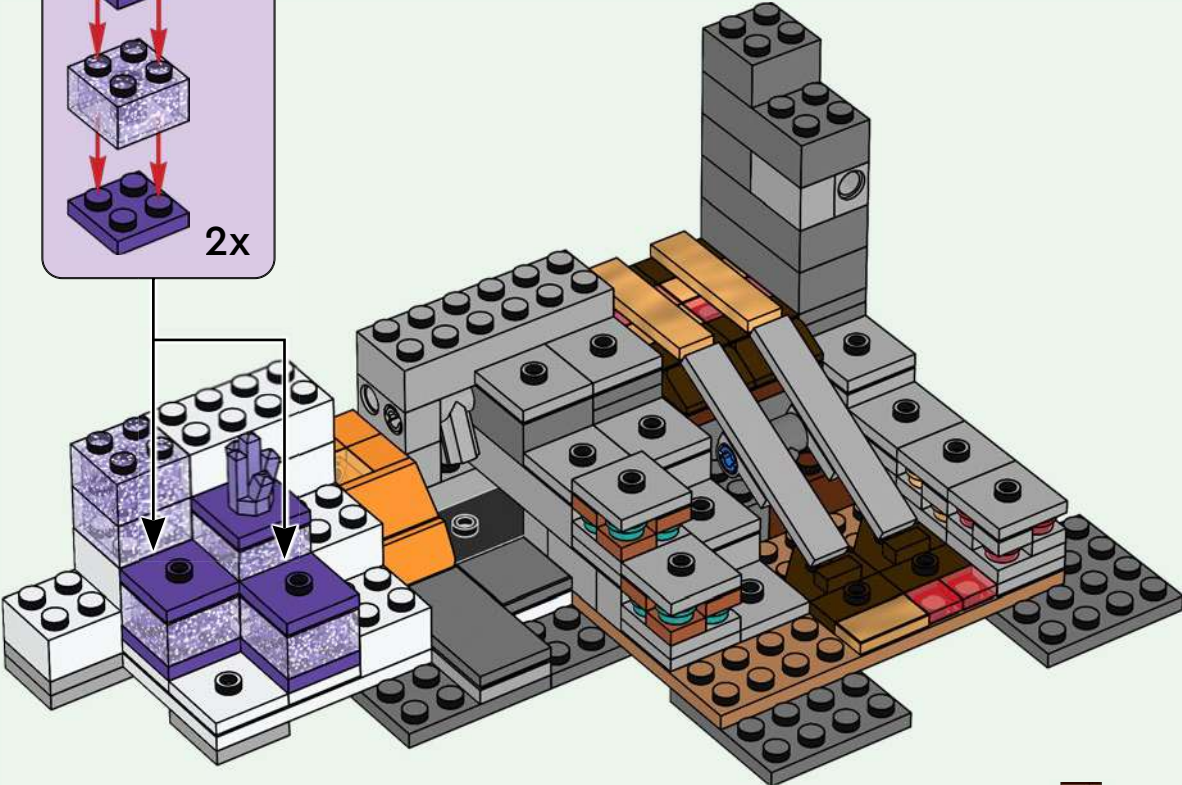
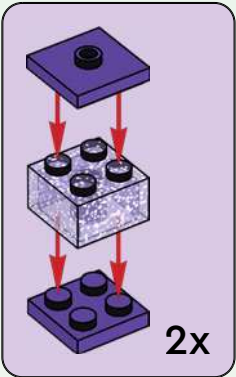

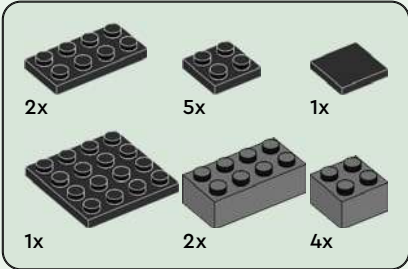
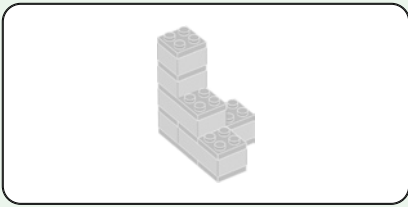

54

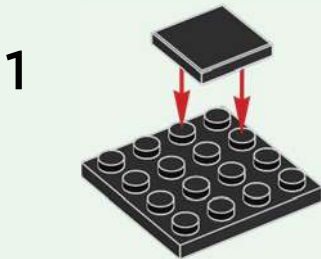

2

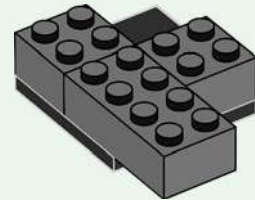

3

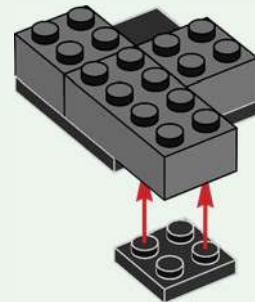

4

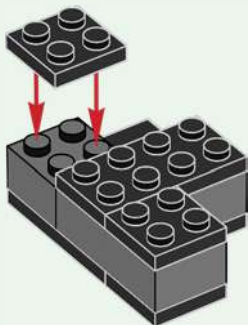

5

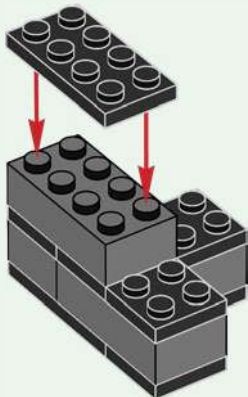

6

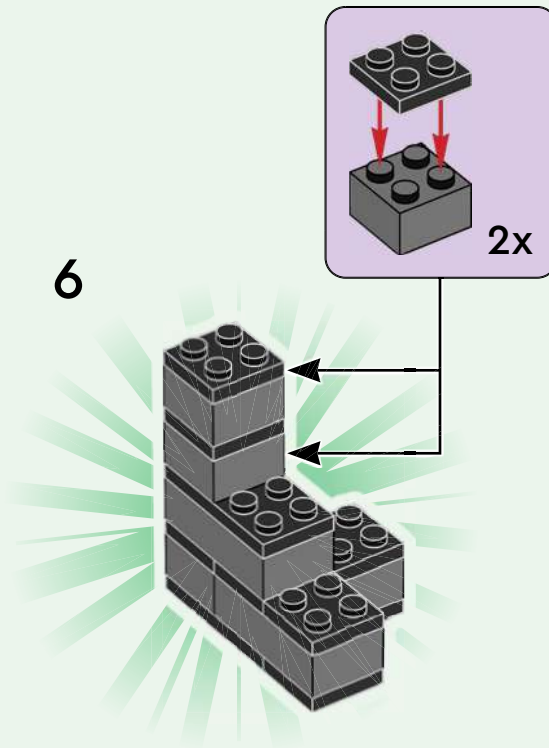

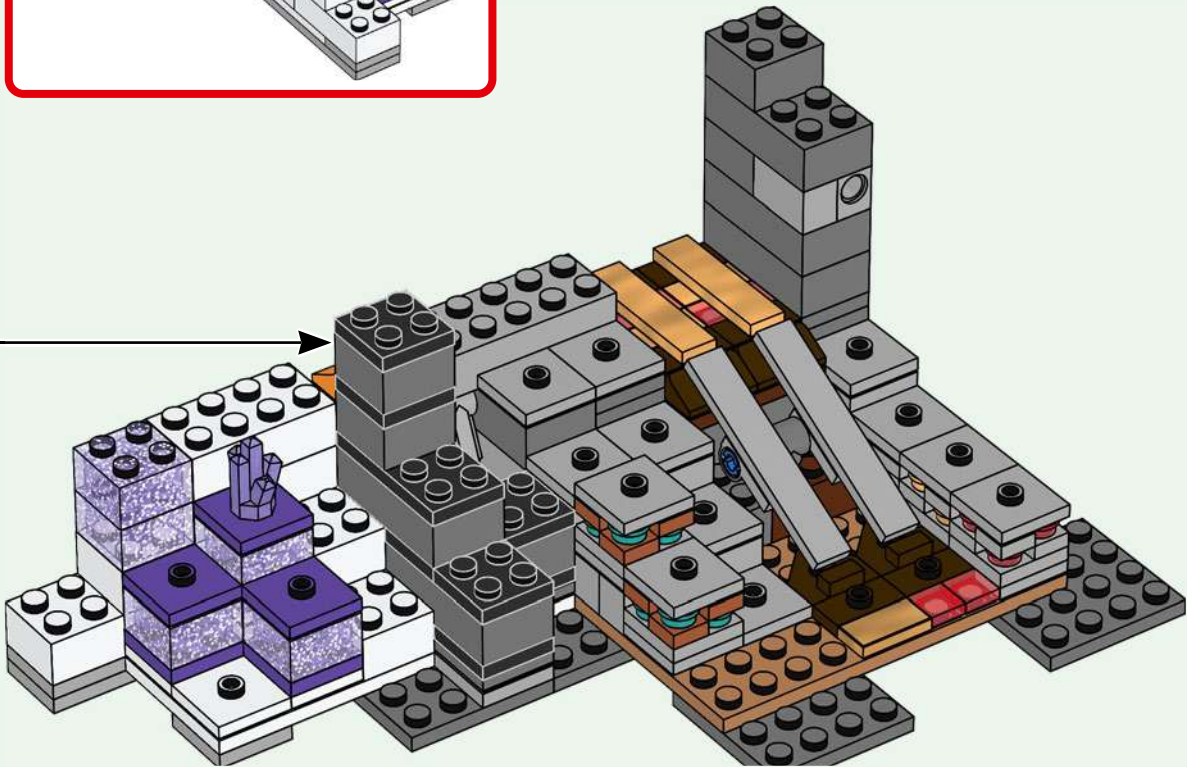
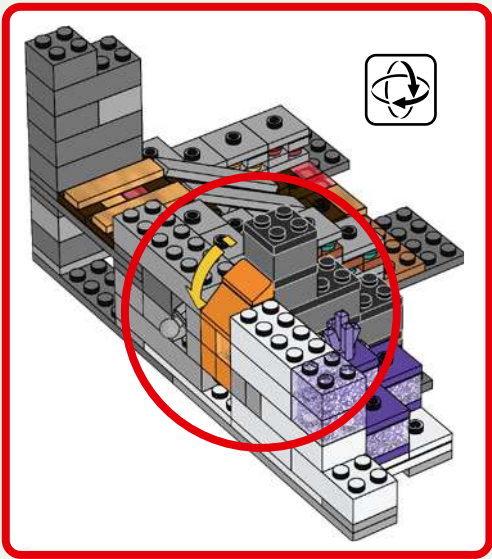



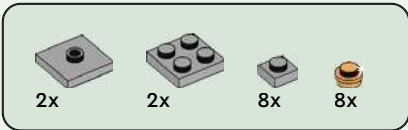

# 56

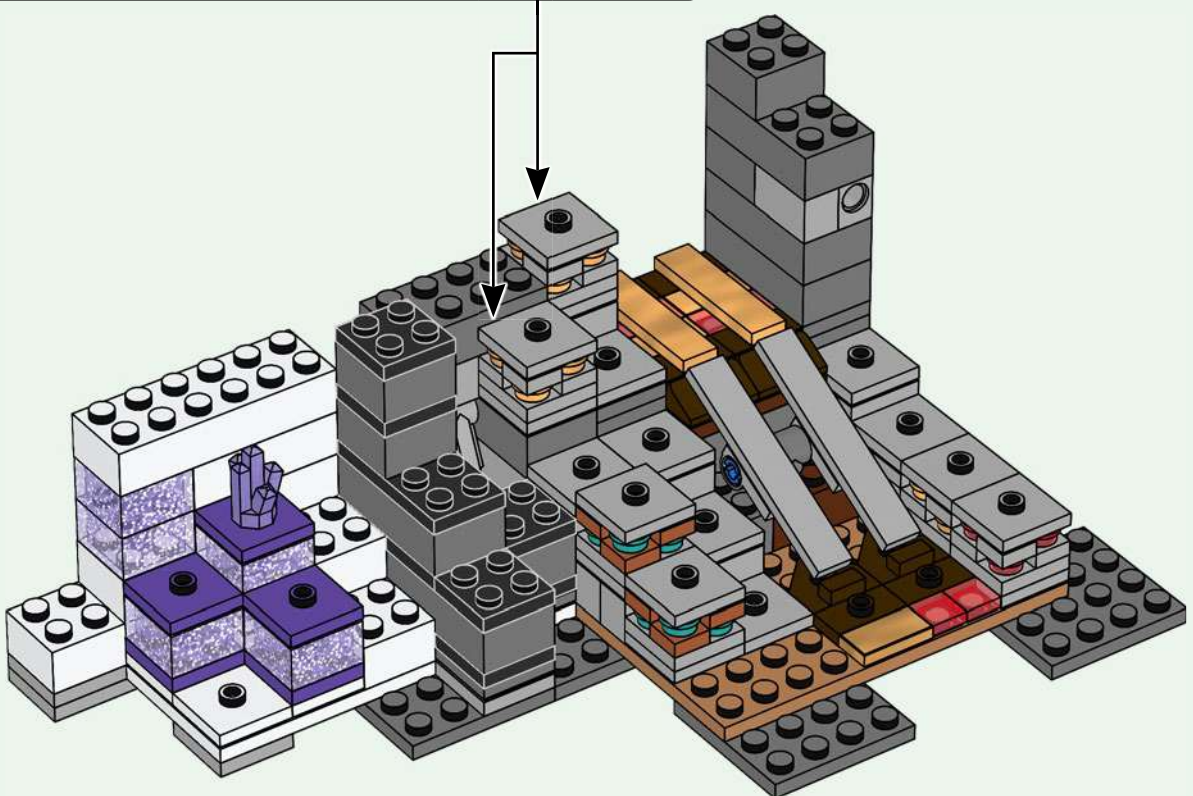
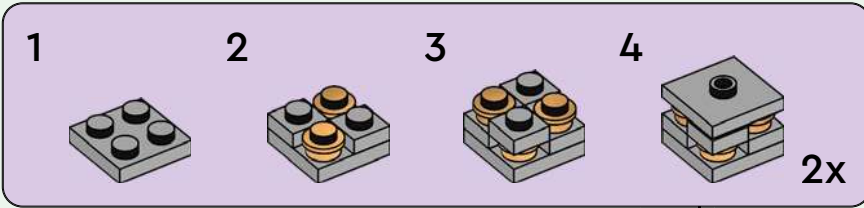

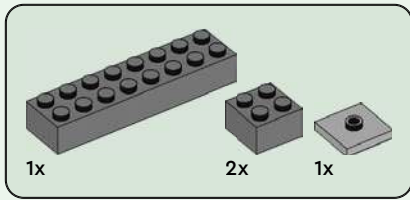

57

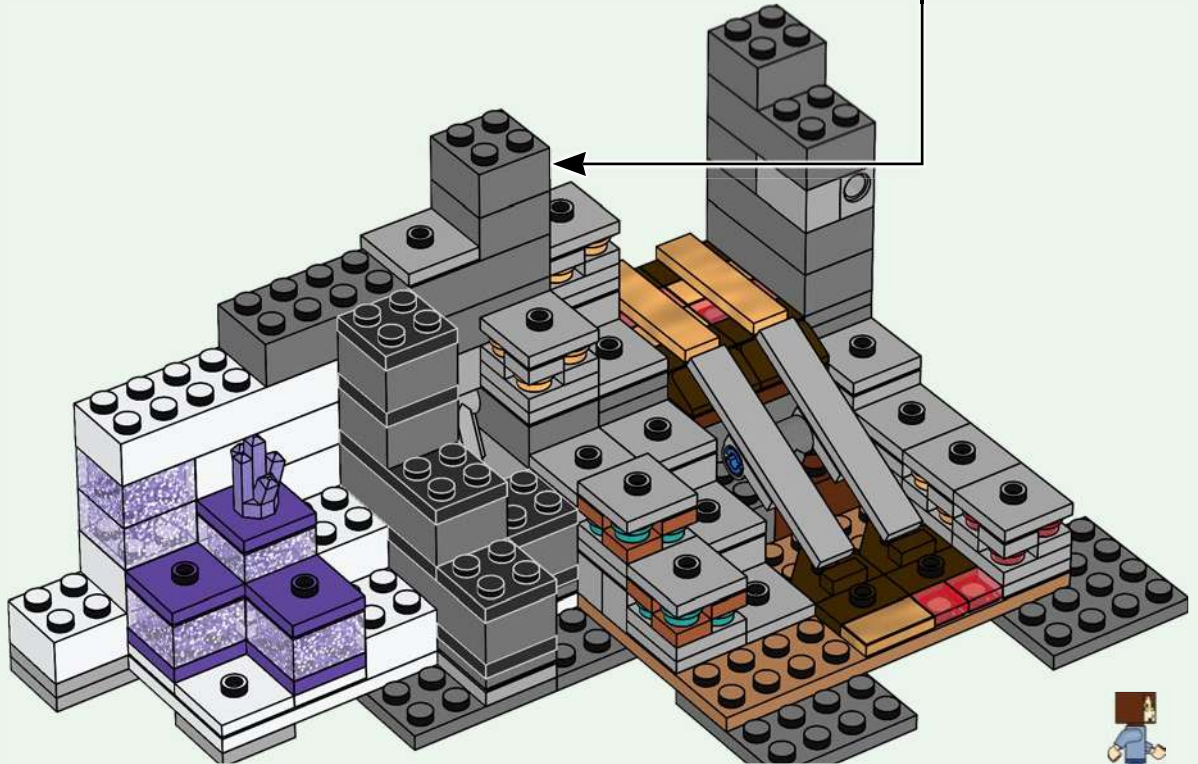
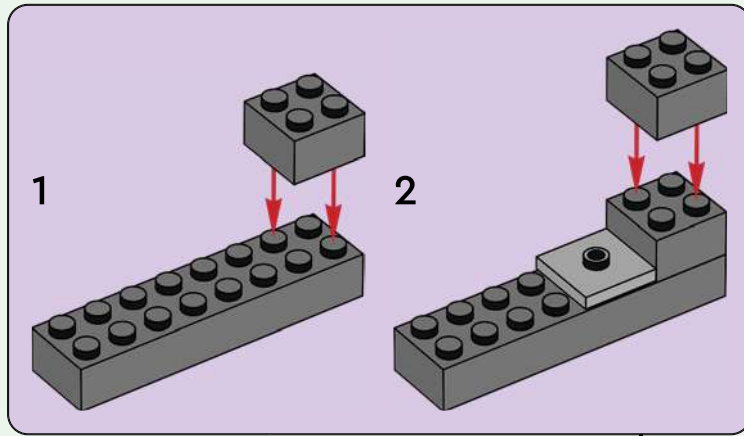

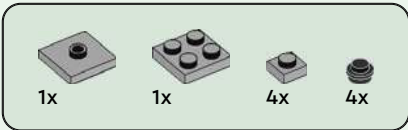

58

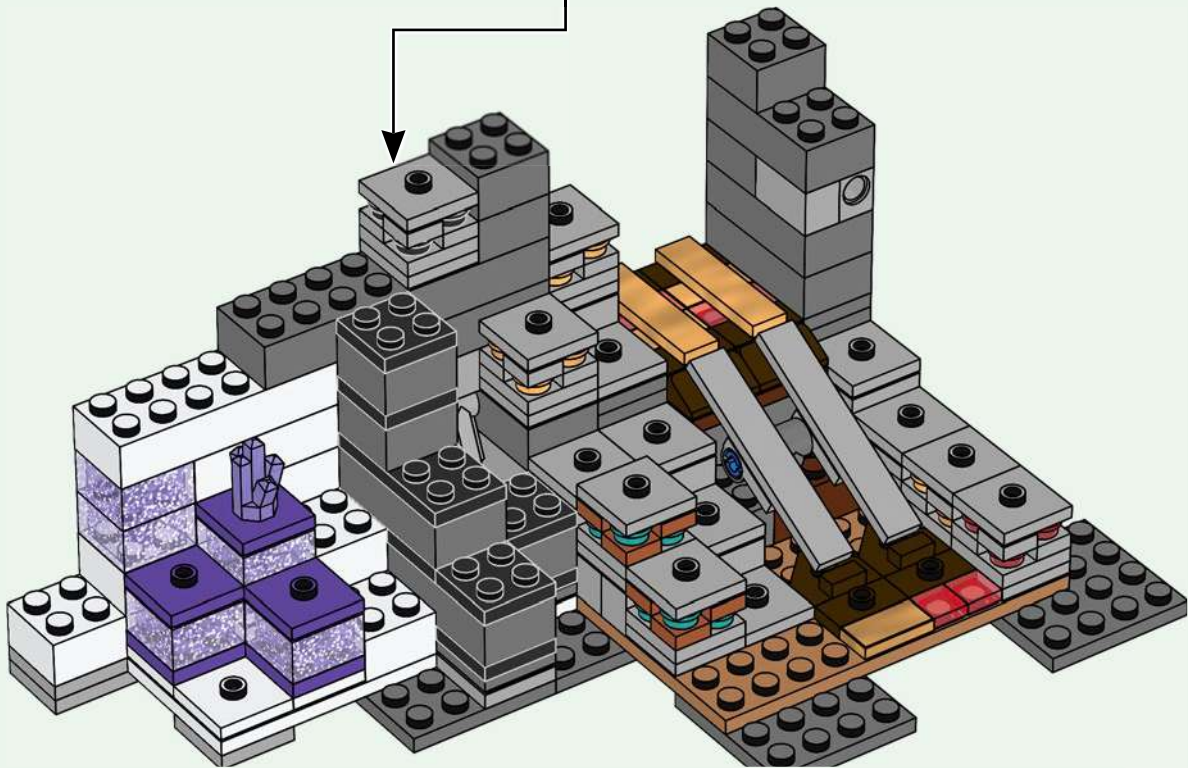
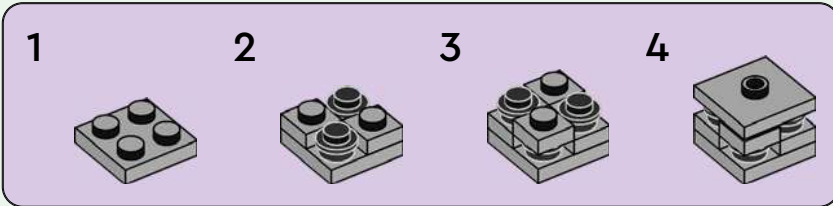

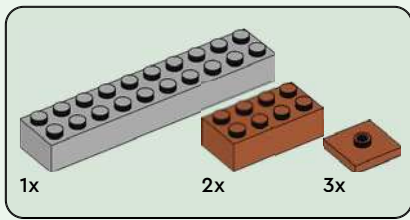

59

1

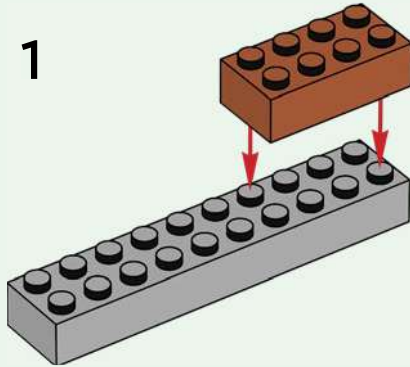

2

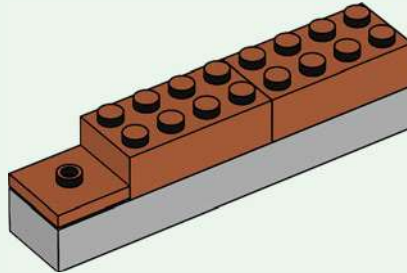

3

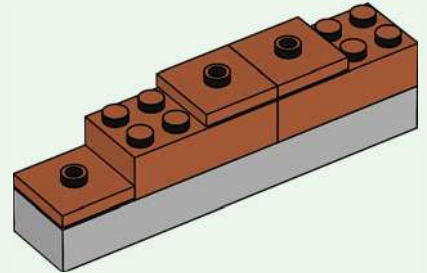

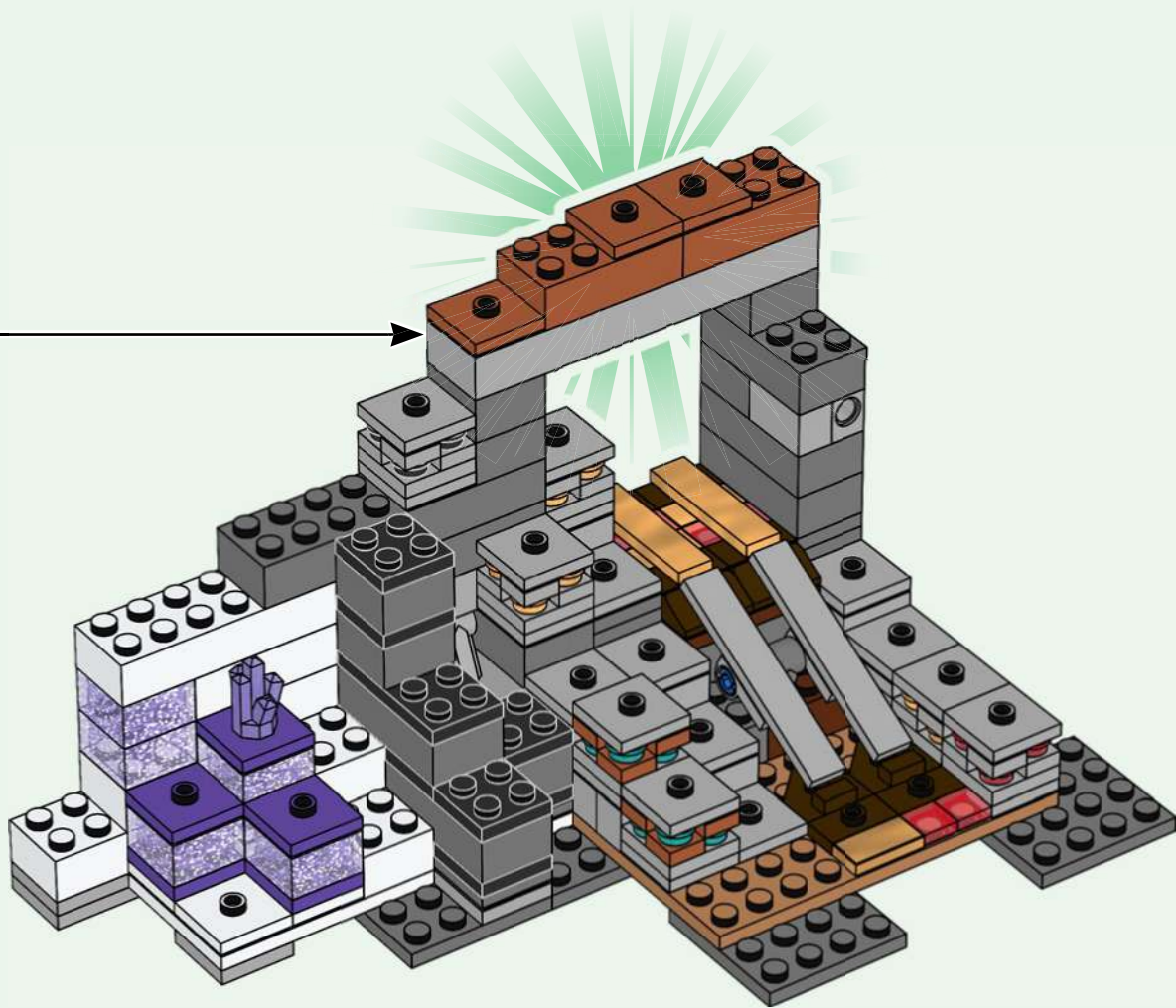

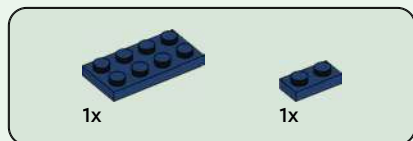

1

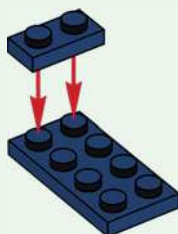

2



3

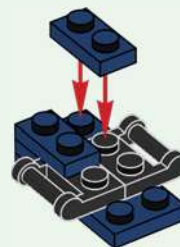

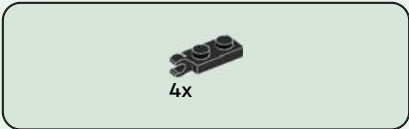

4

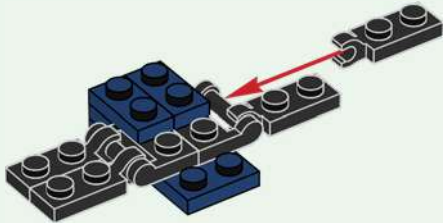

5

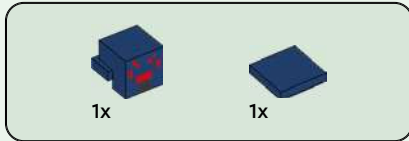
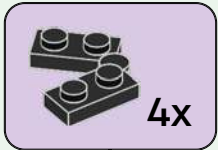
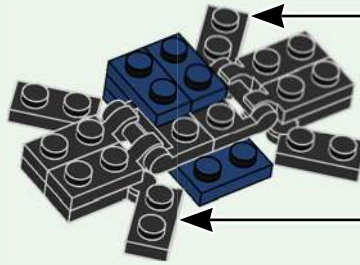

6

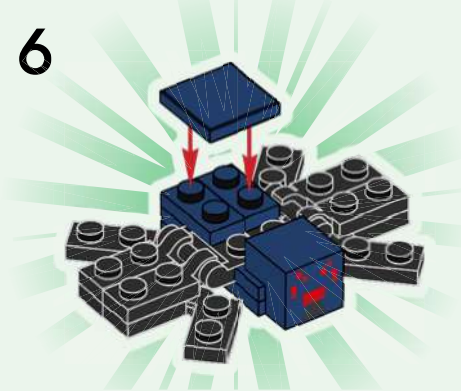

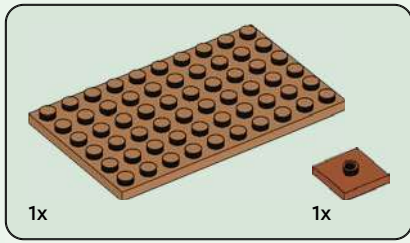

60

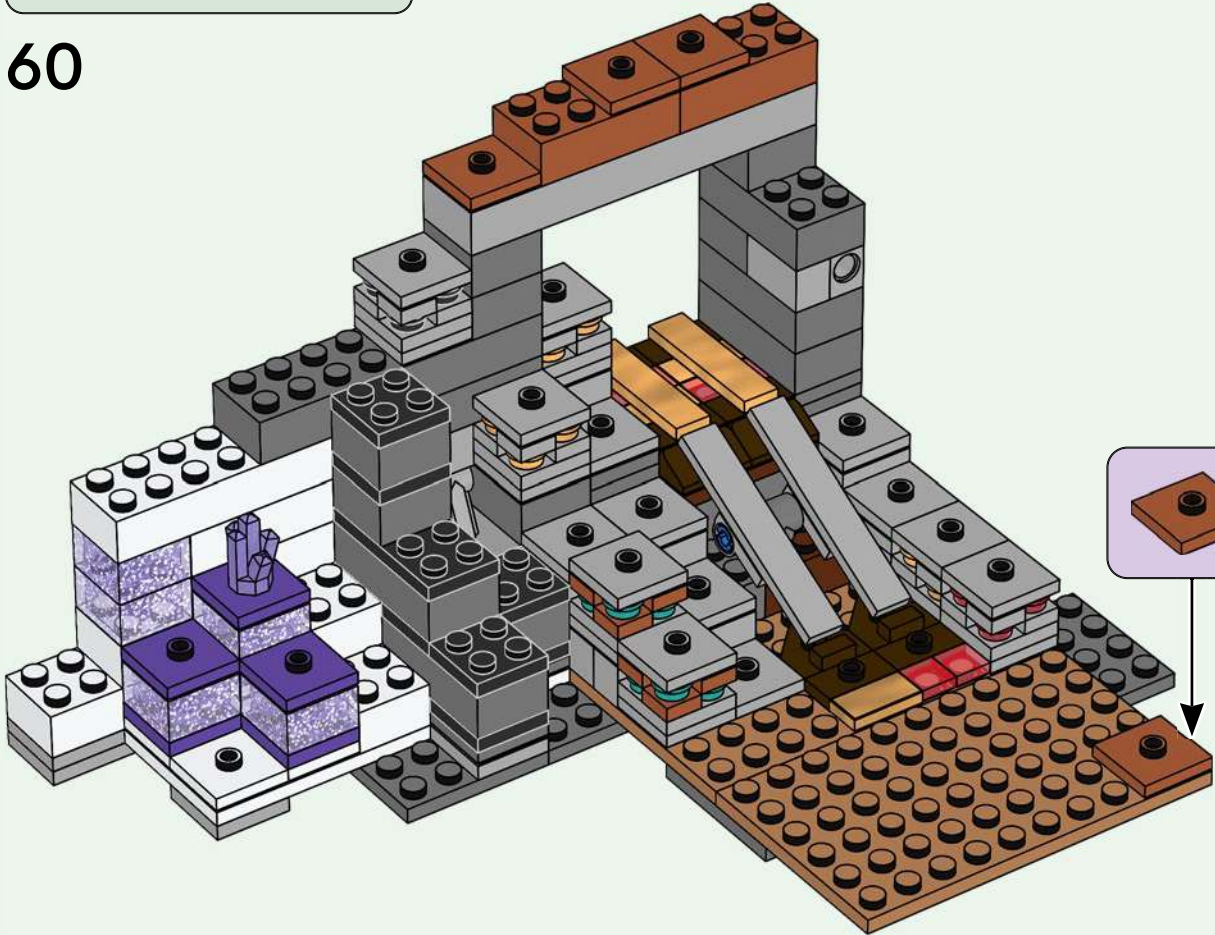

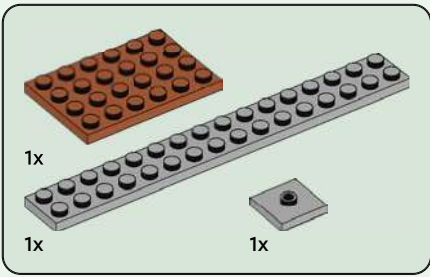

61

1

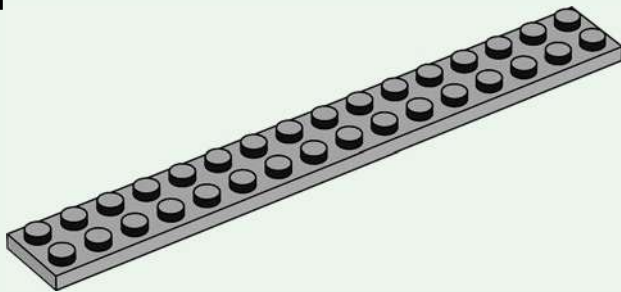

2

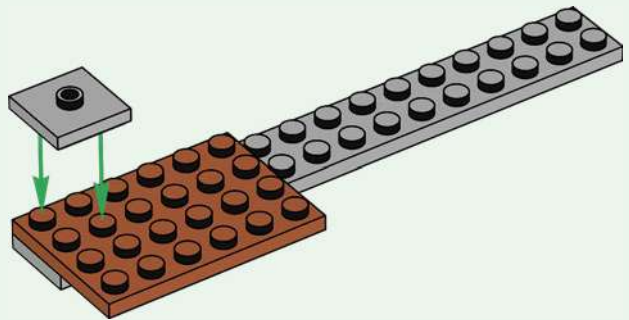

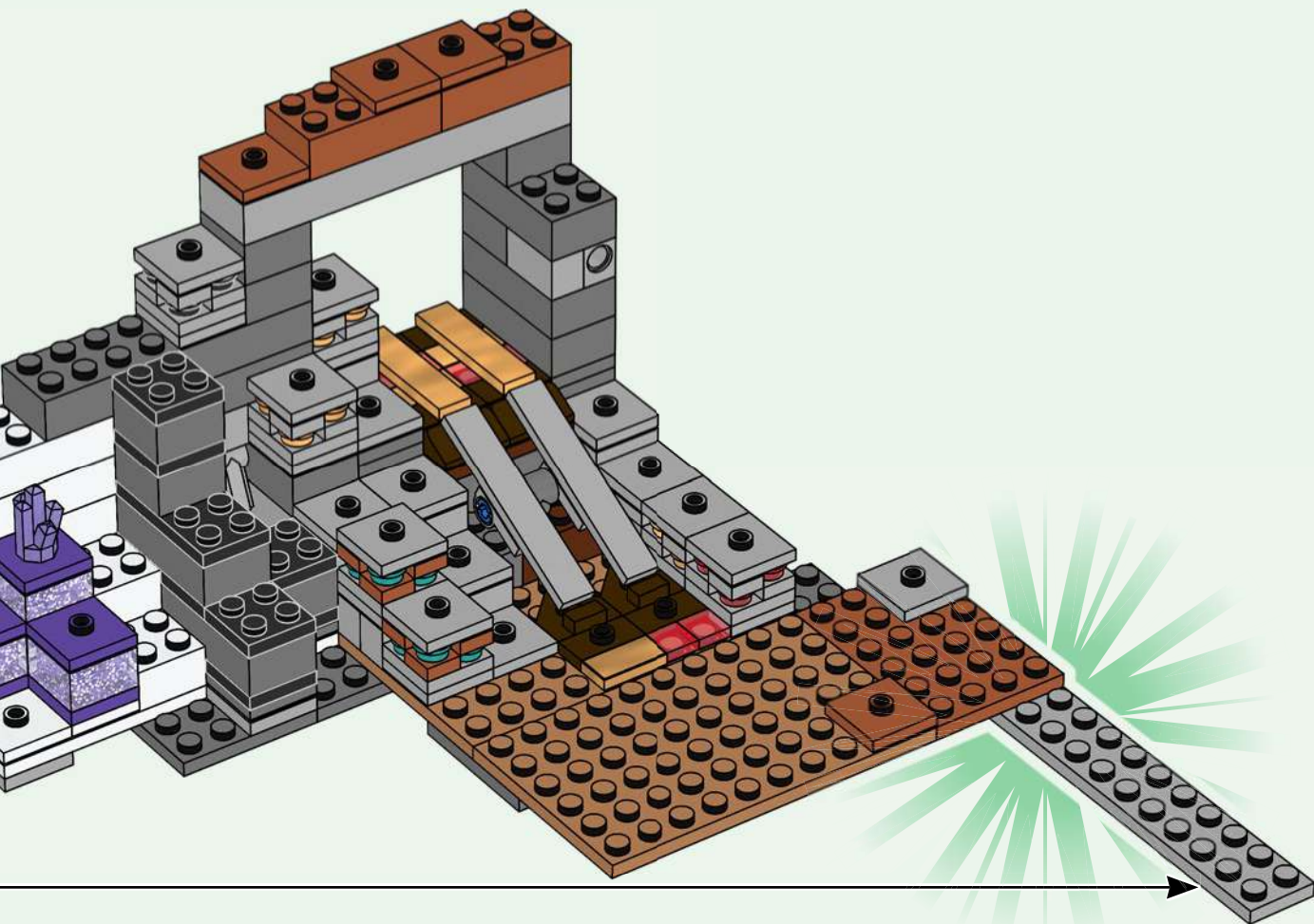



2x

62

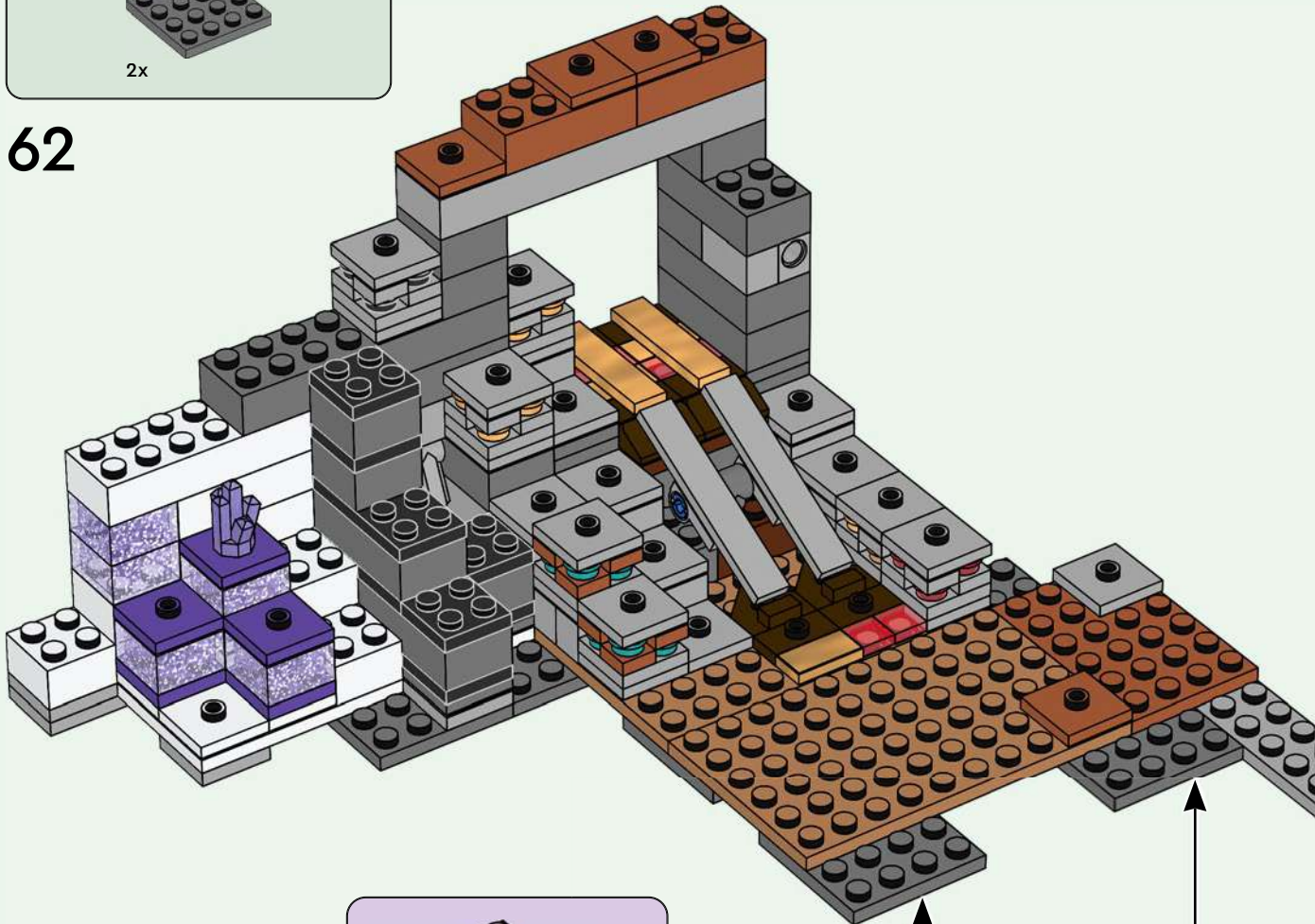

2x



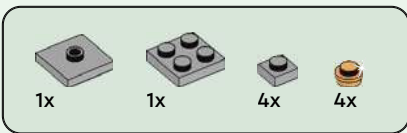



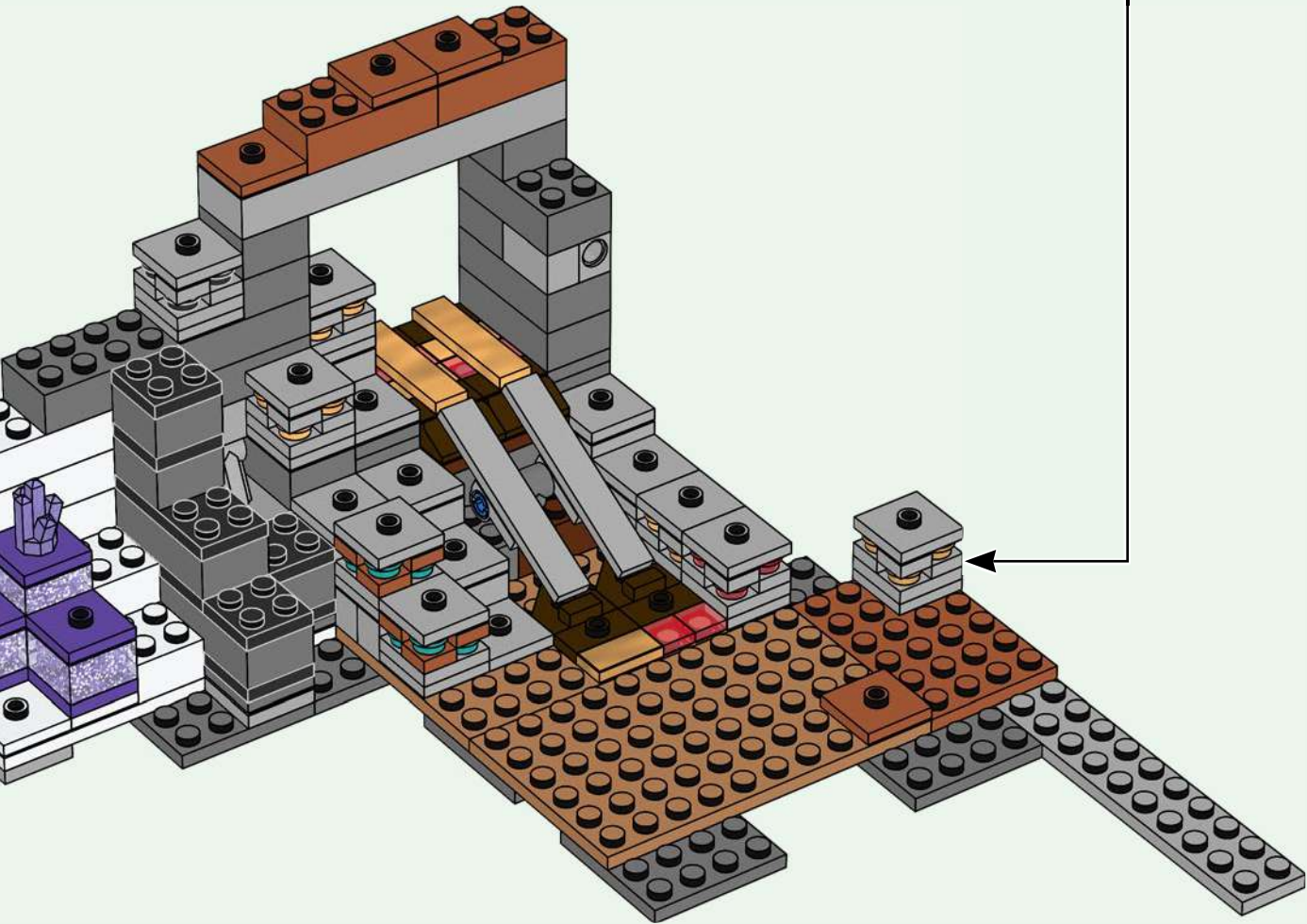
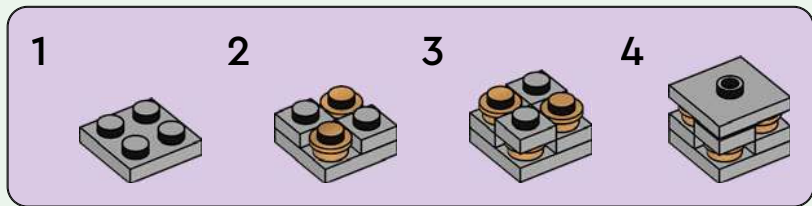

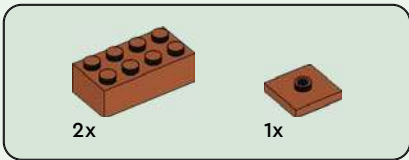
63



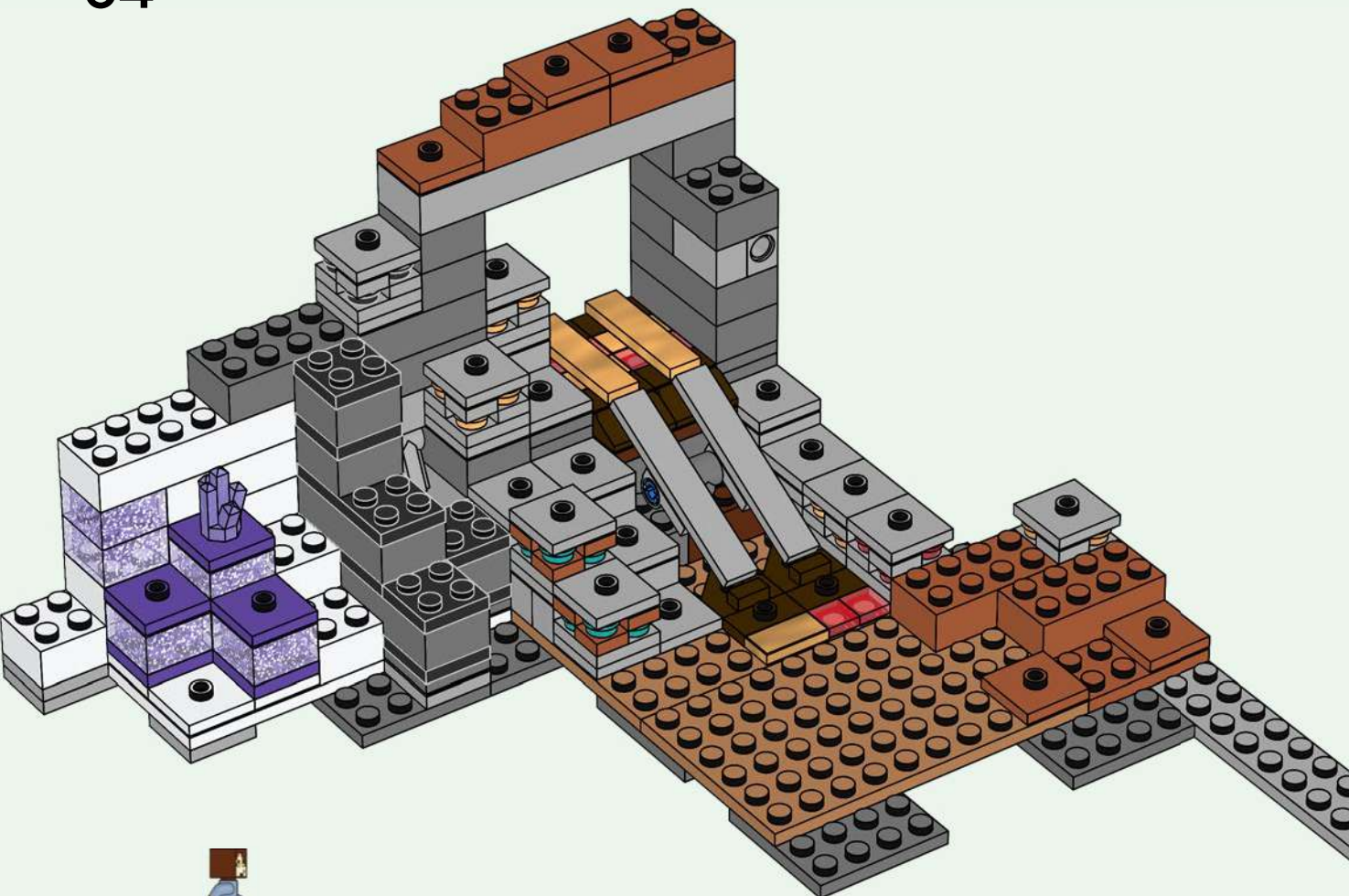

64



|   |  |  |  |
|---|--|--|--|
|  |  |  |  |
| 2x  | 1x   | 1x   | 6x   |

65

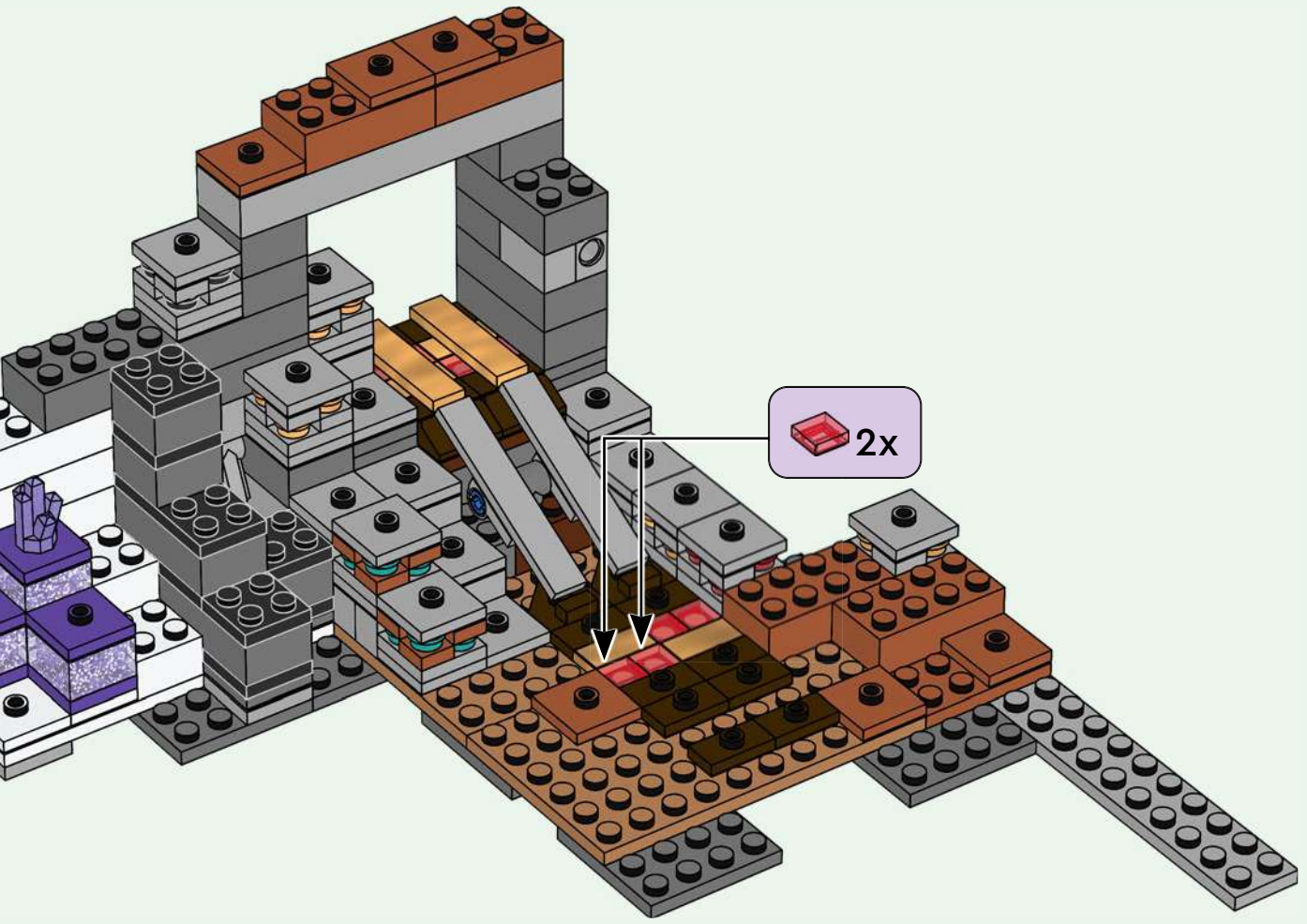

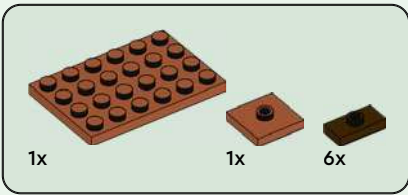

66

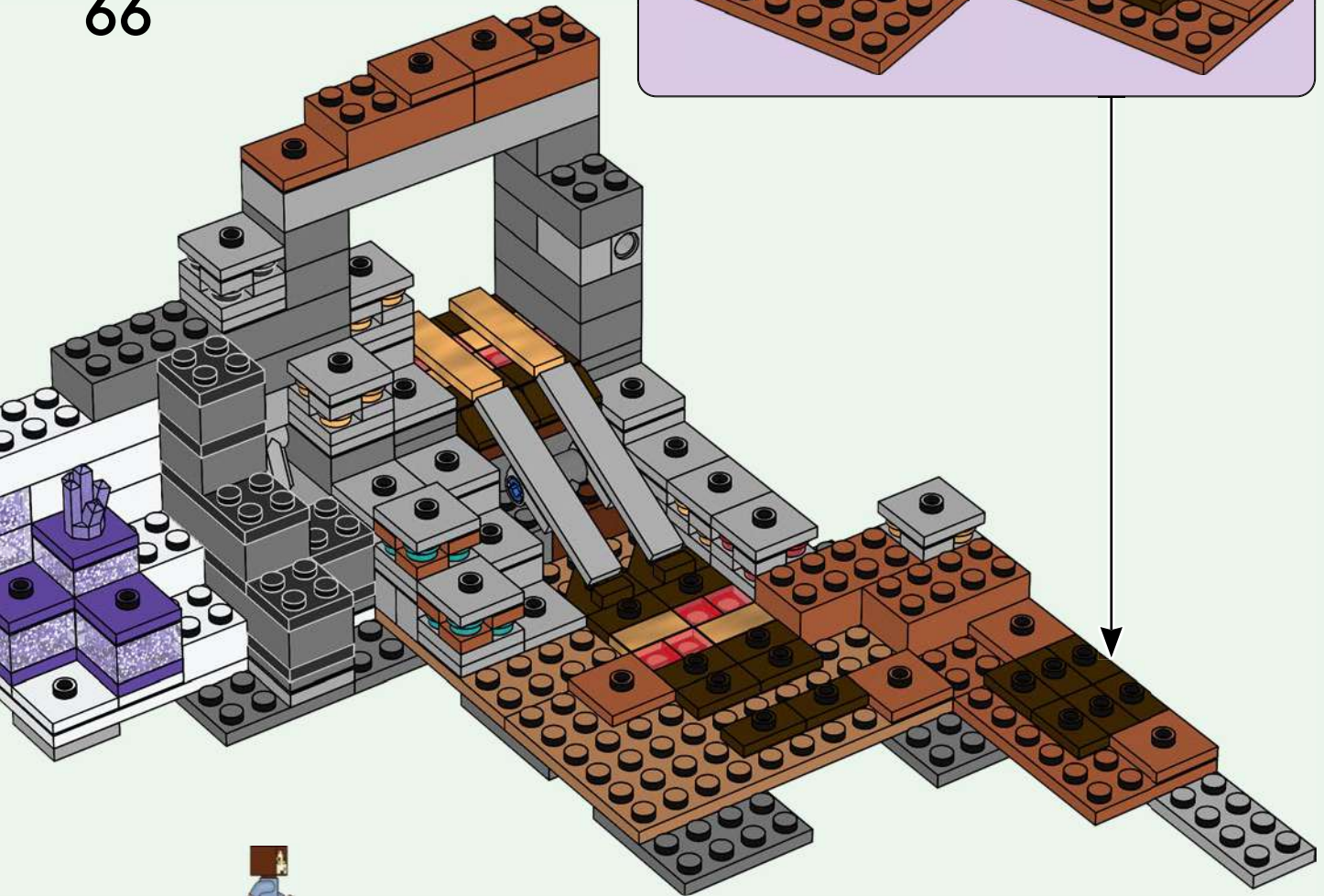
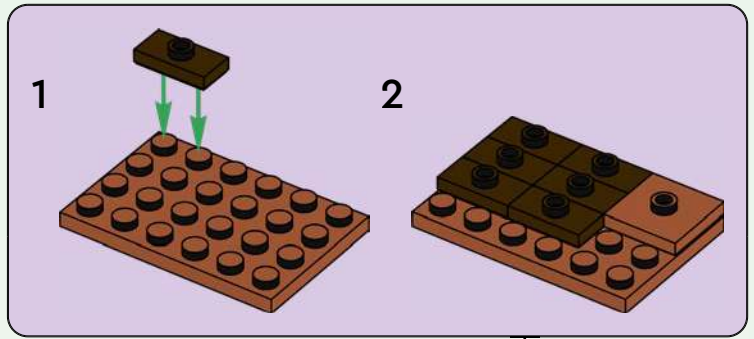



1x

67

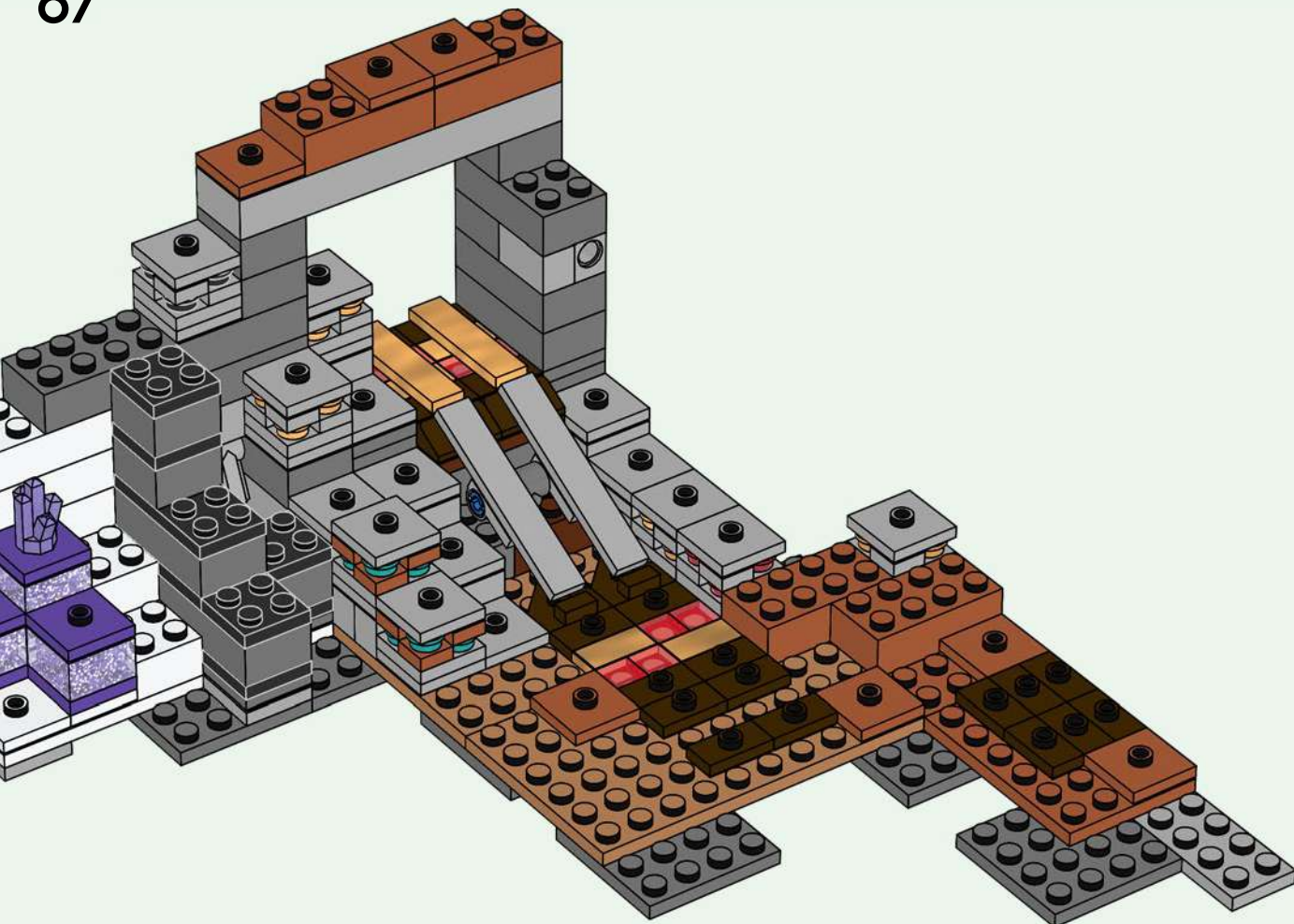

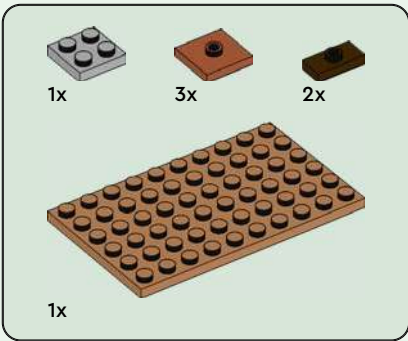

68

1

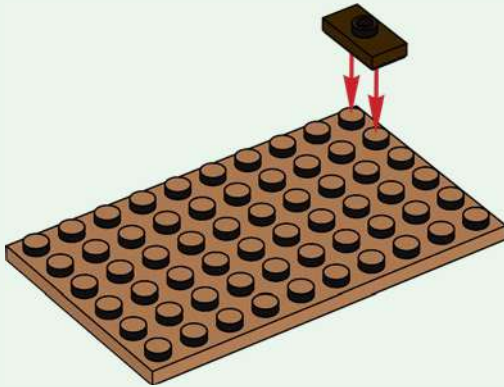

2

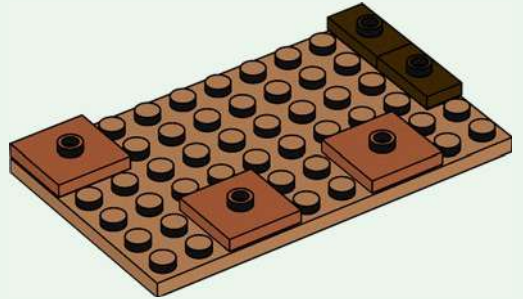

3

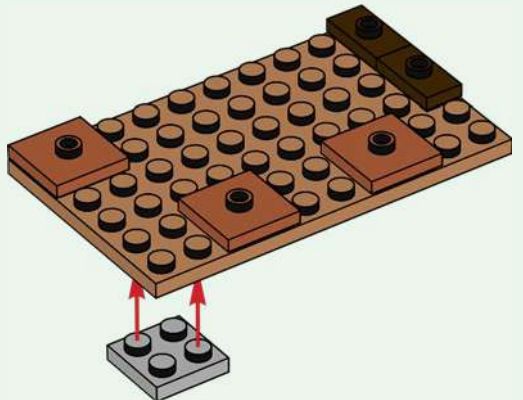

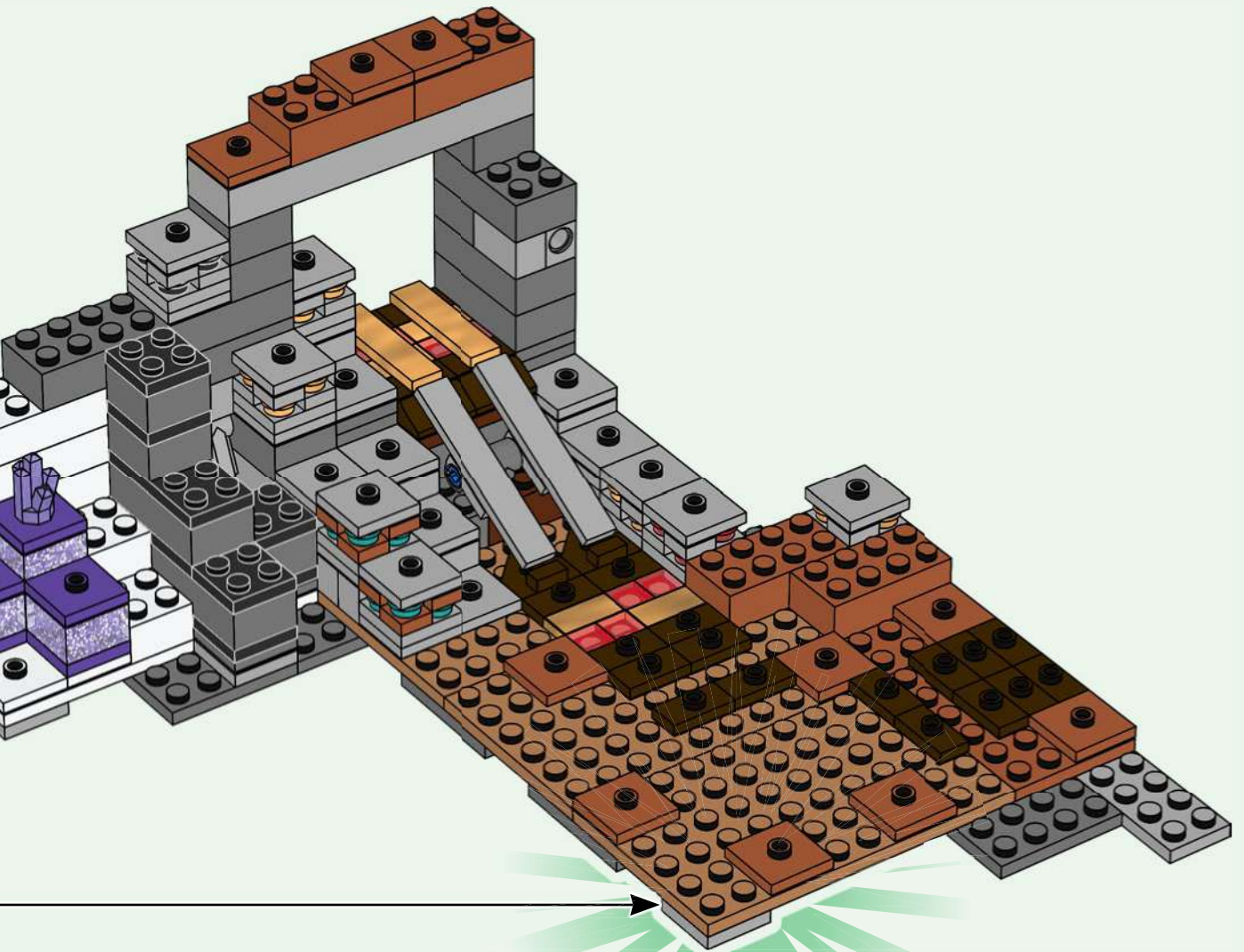

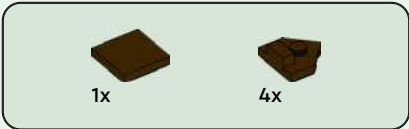

69

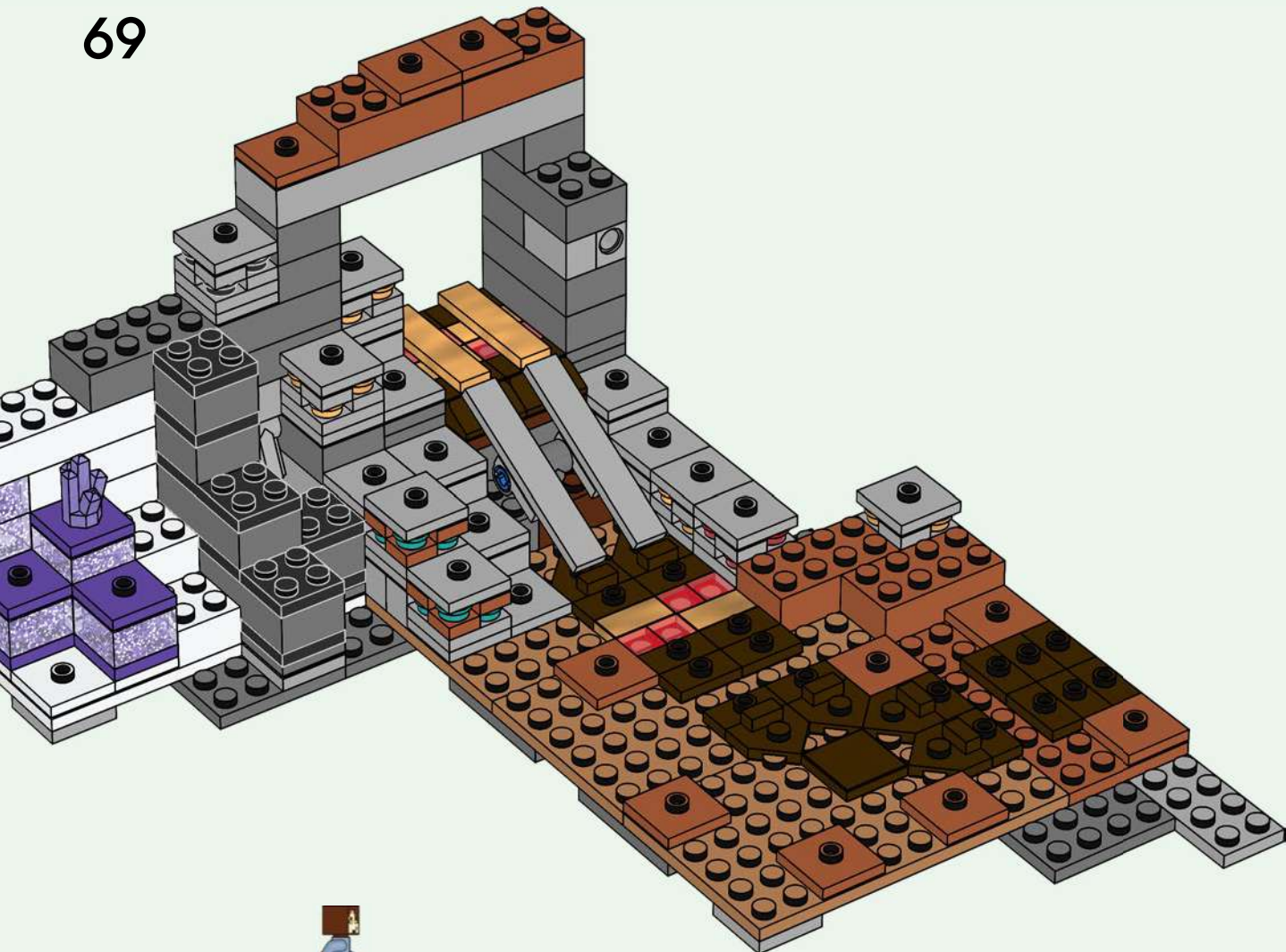

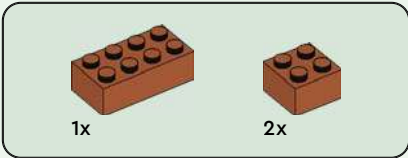



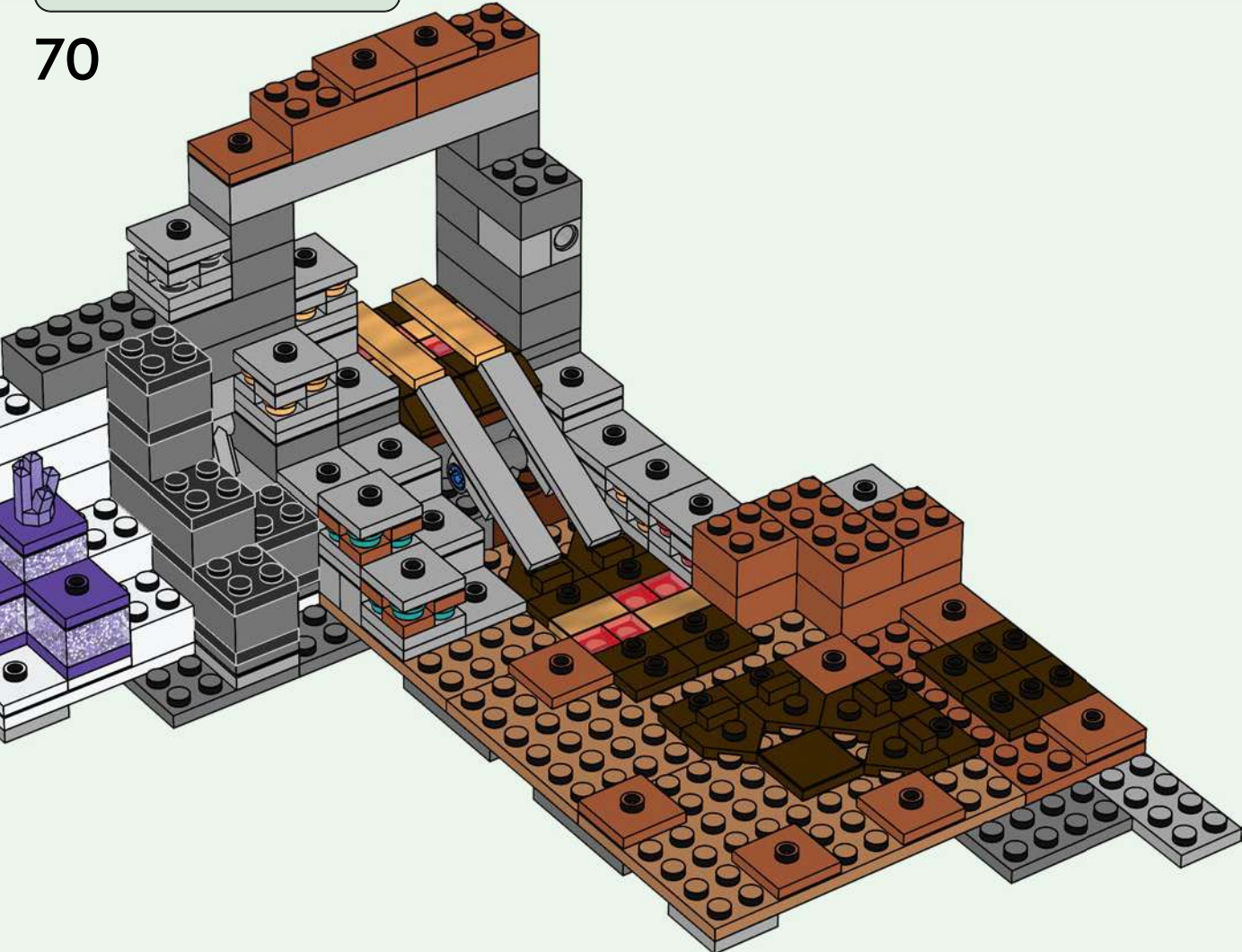

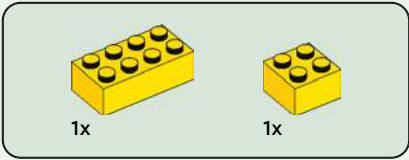
70



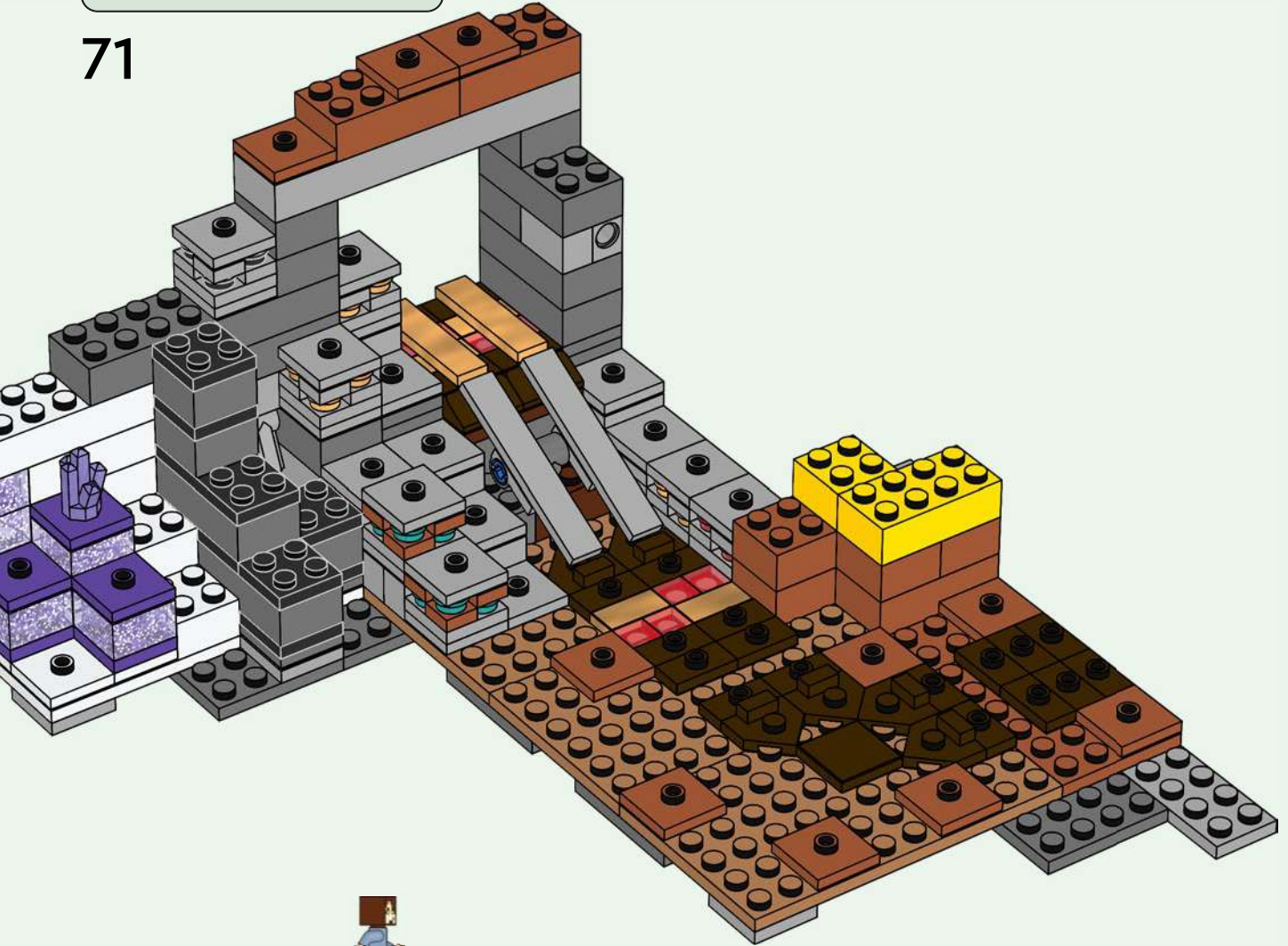



71

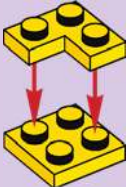

1x  2x  1x 

72

1  2  3 

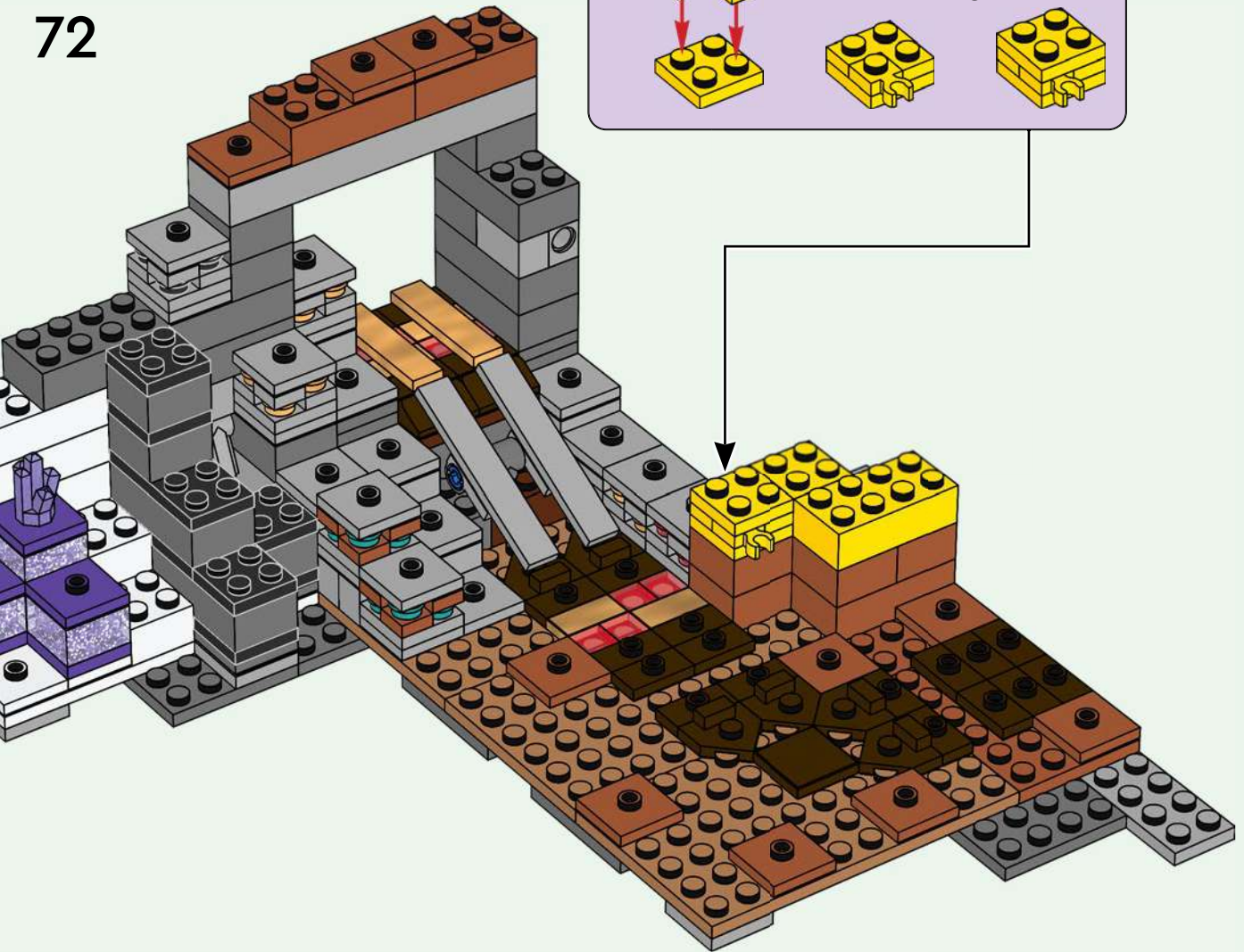

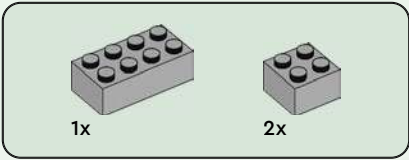

73

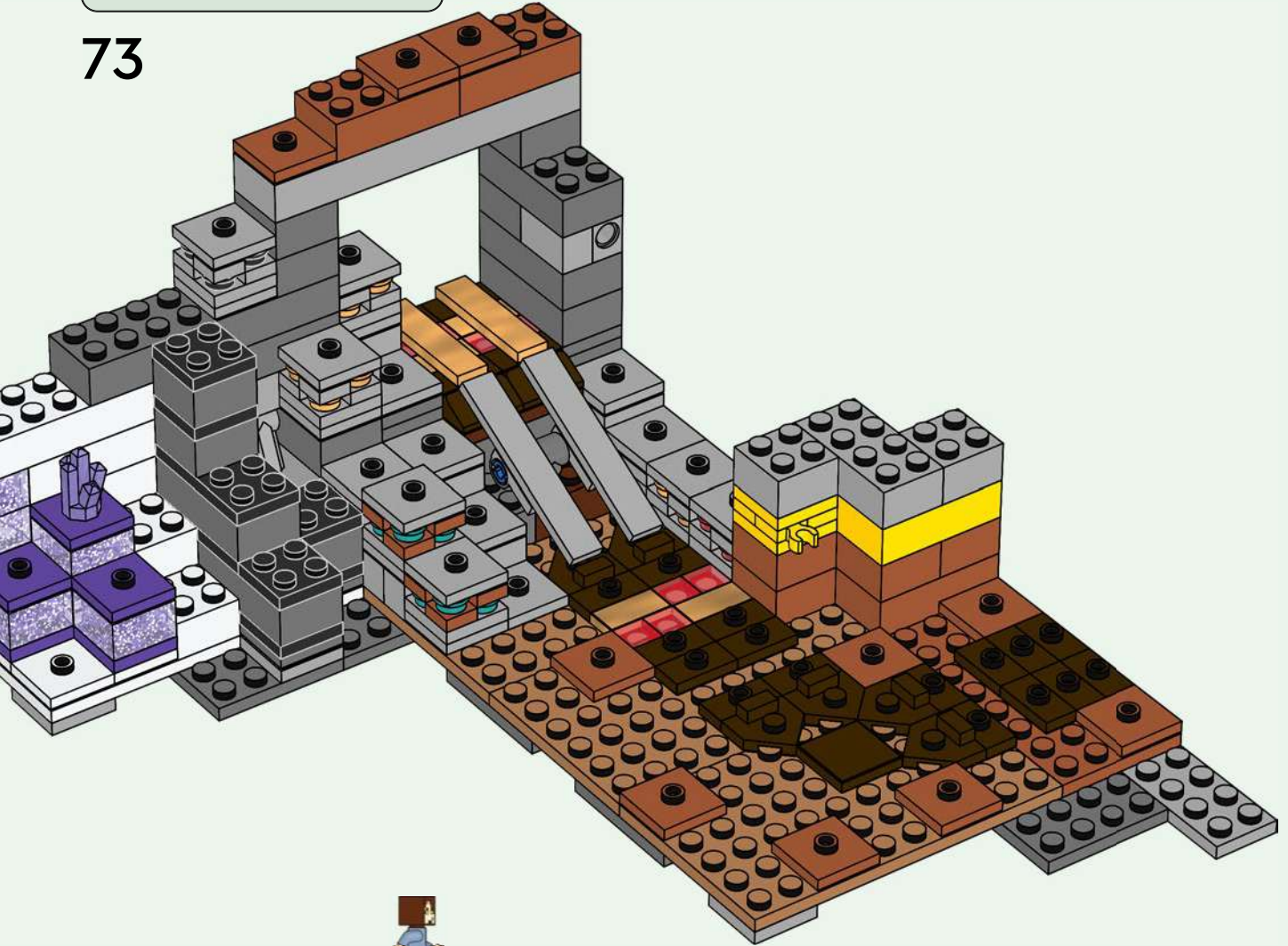



2x

74

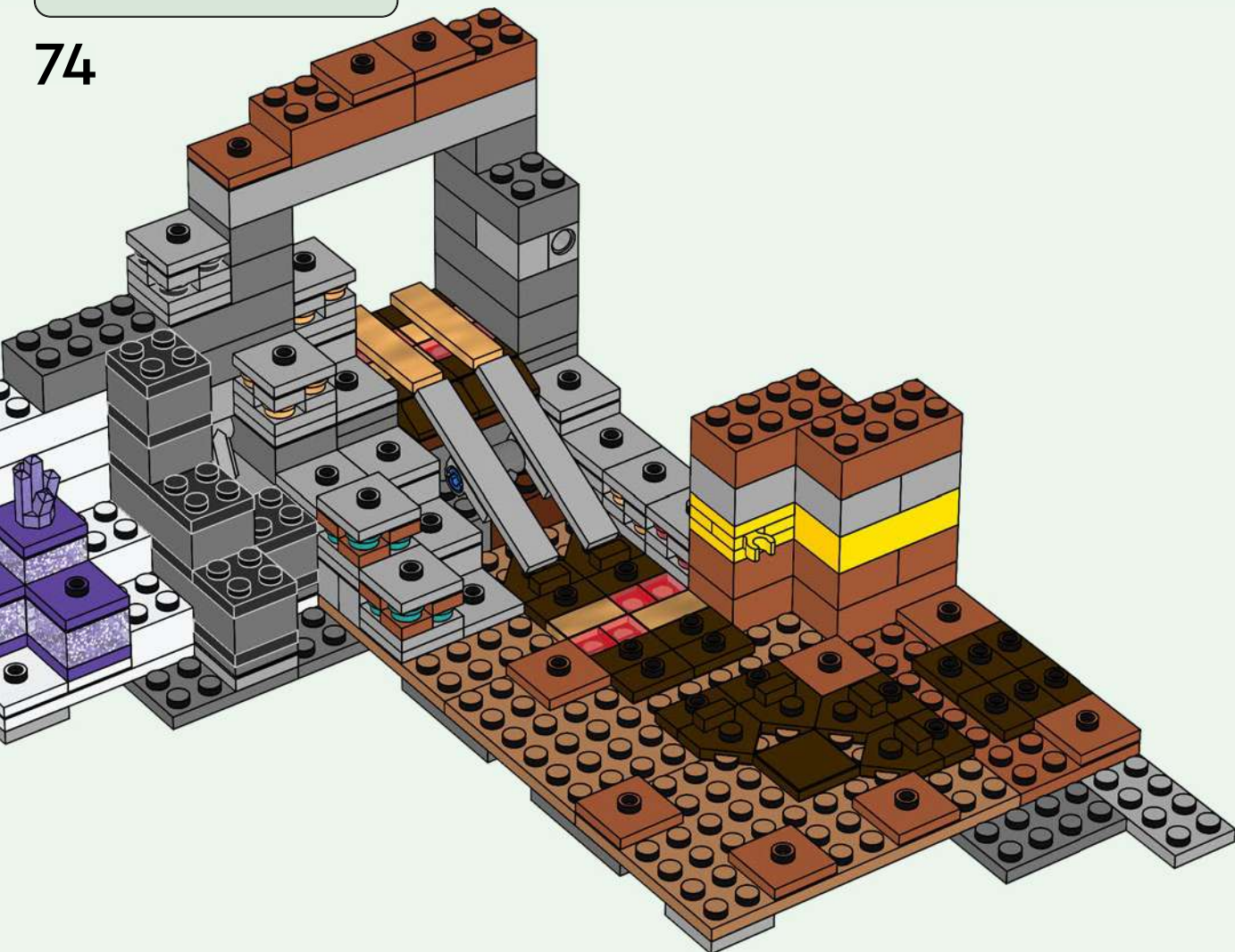



2x

75

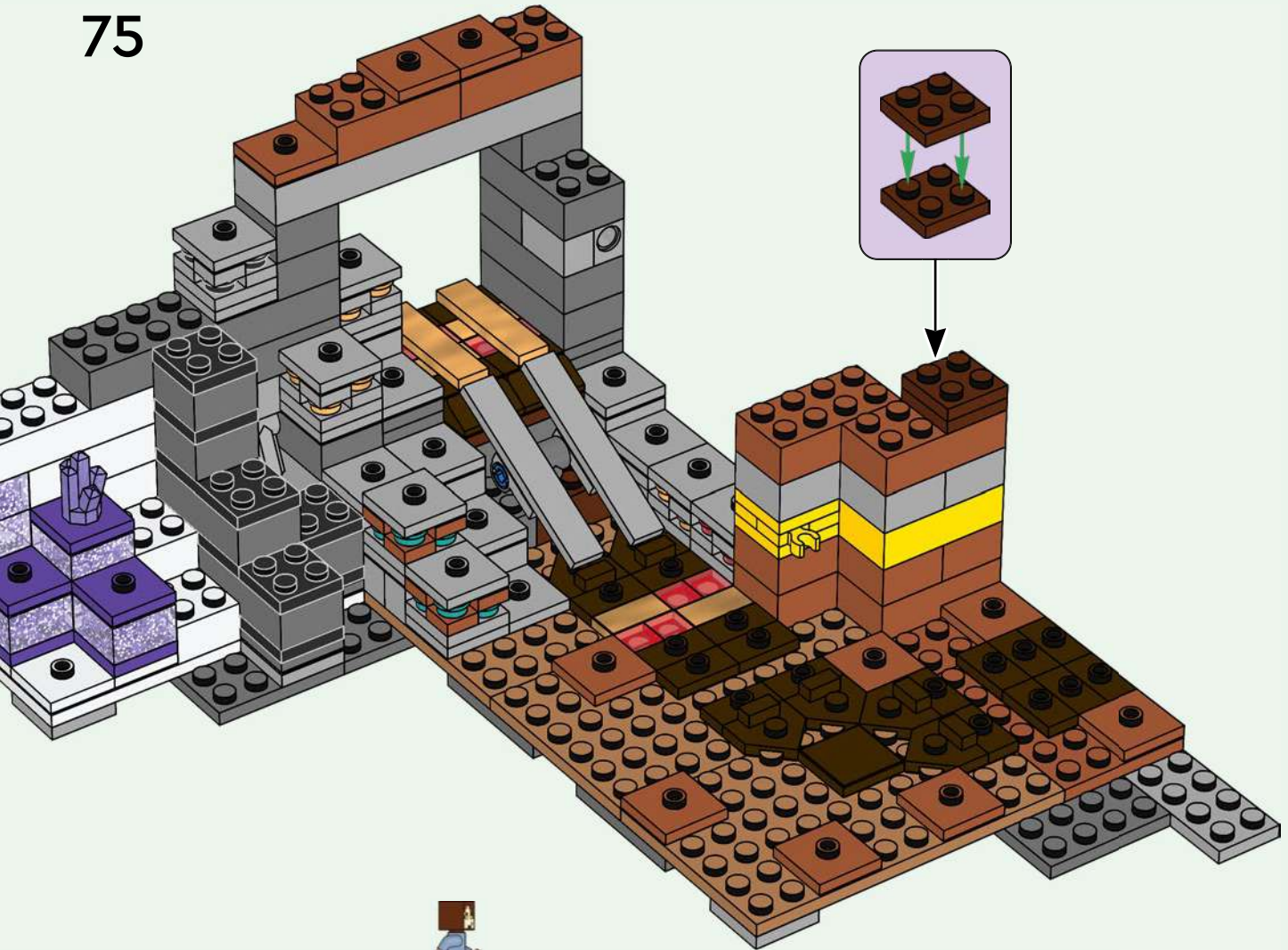

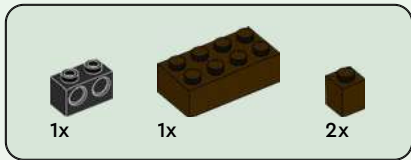

76

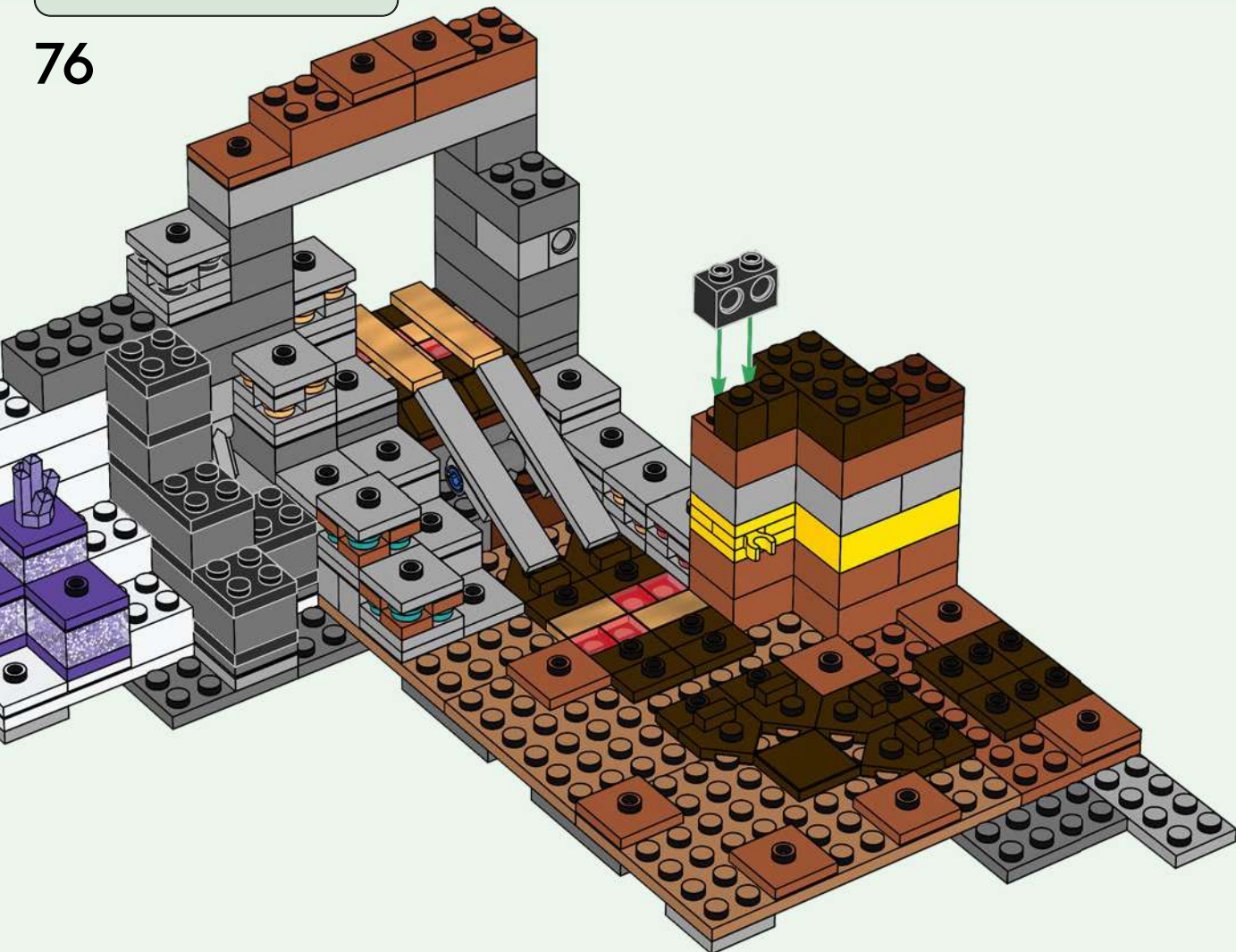



1x

77

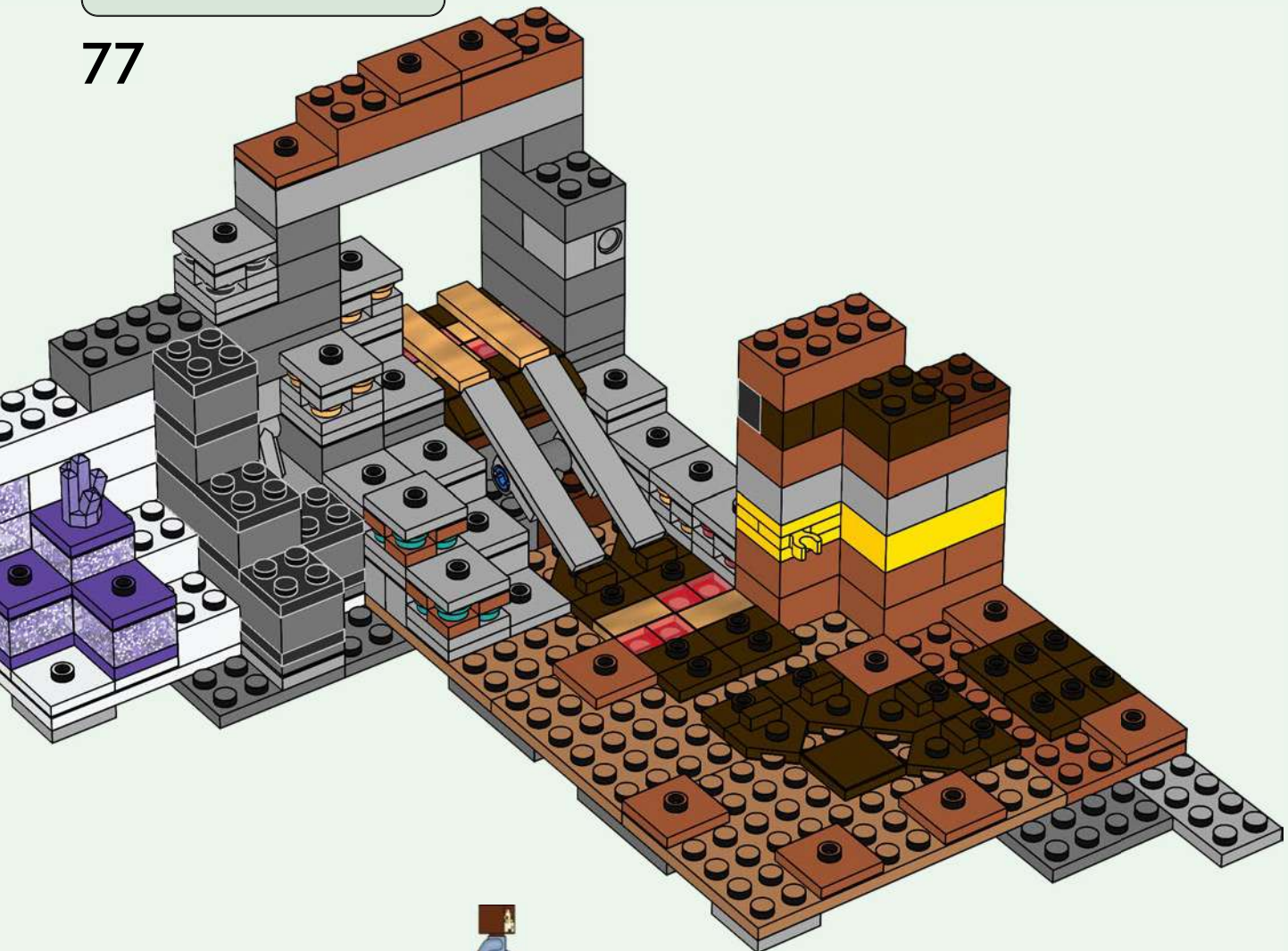

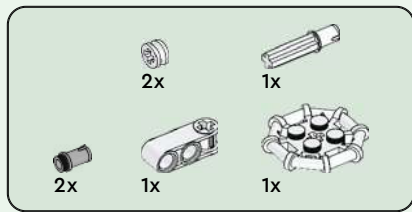

78

1

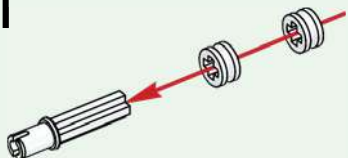

2



3

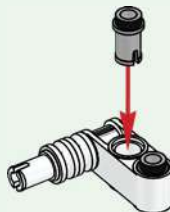

4



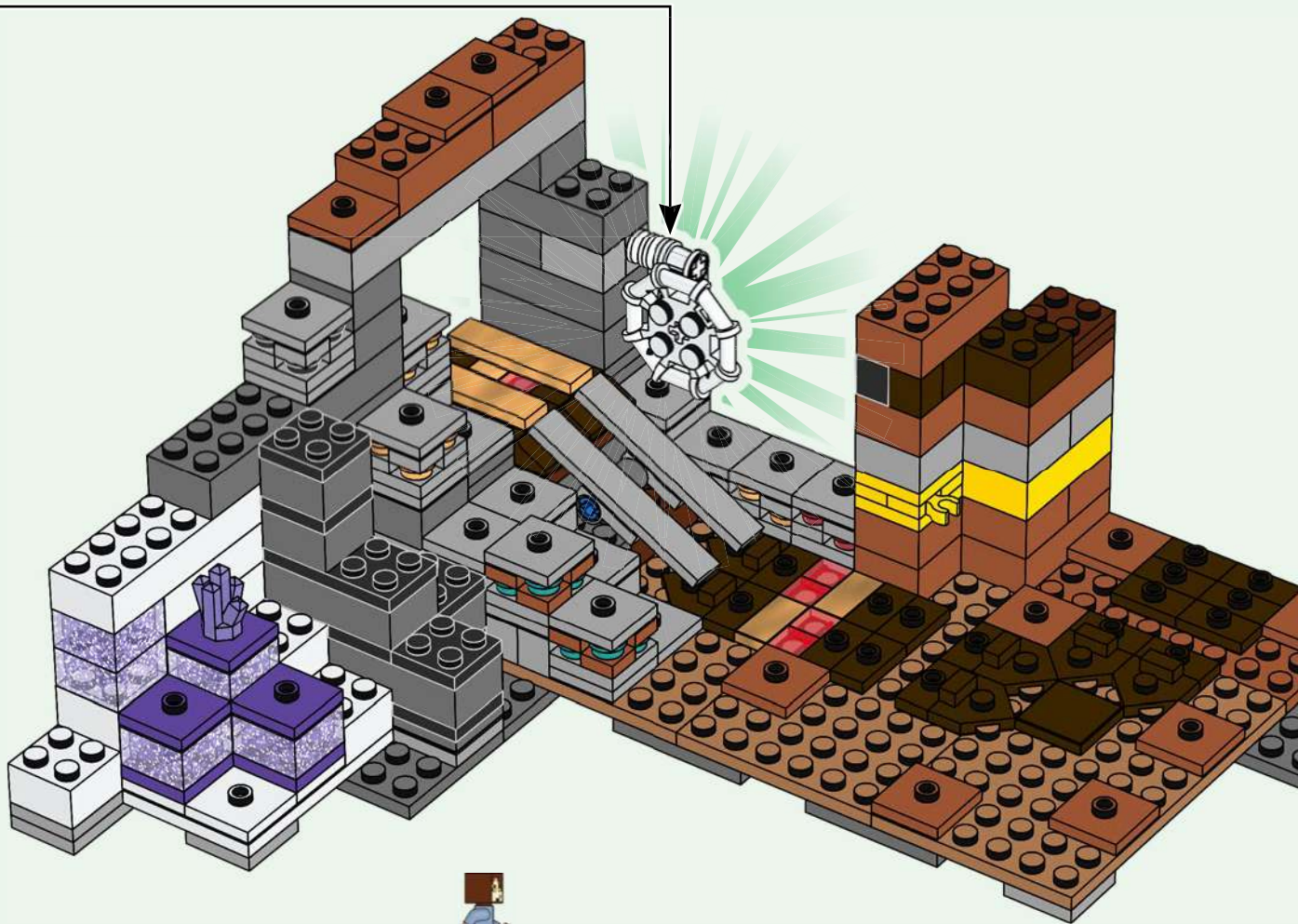

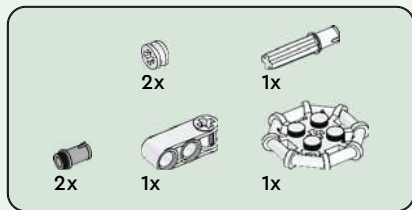

79

1

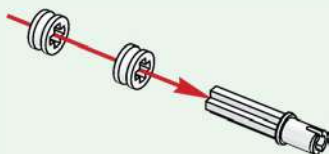

2



3

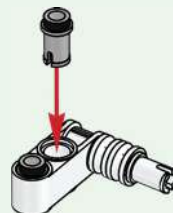

4



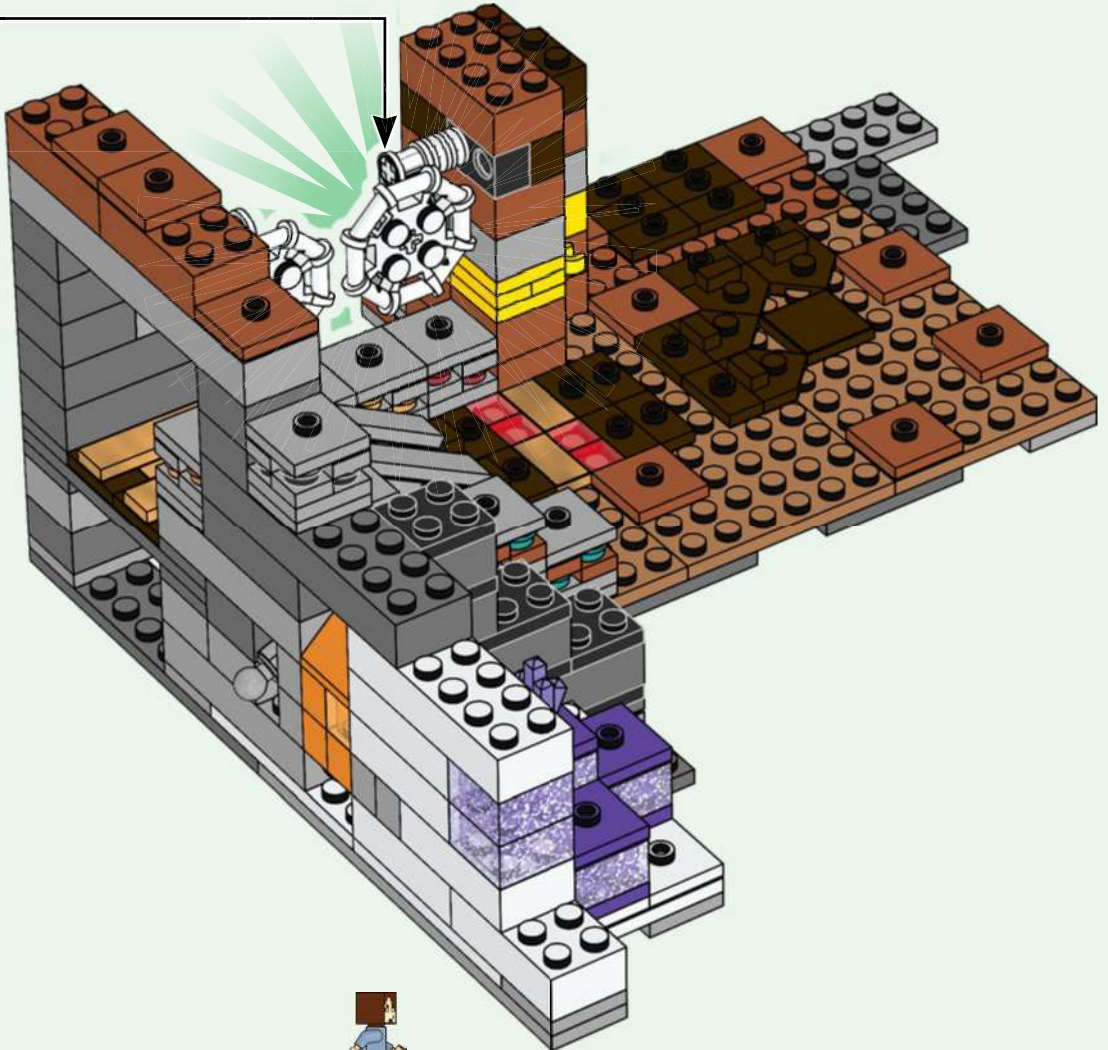

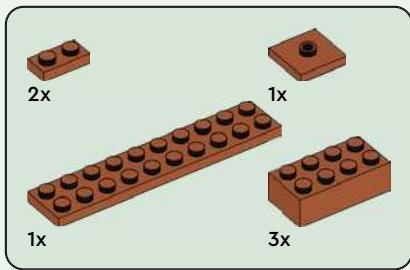

80

1

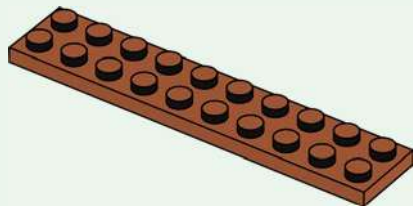

2

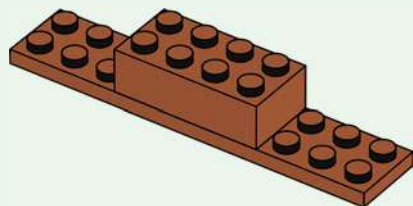

3

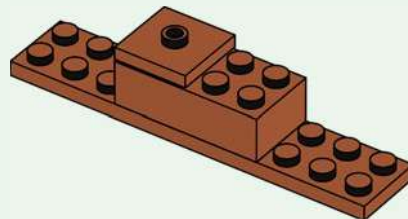

4

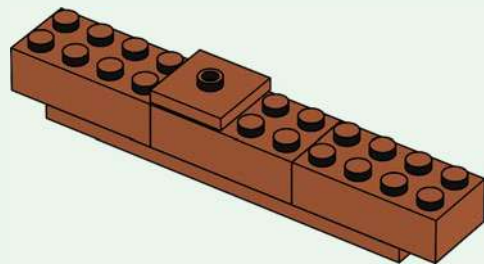

5

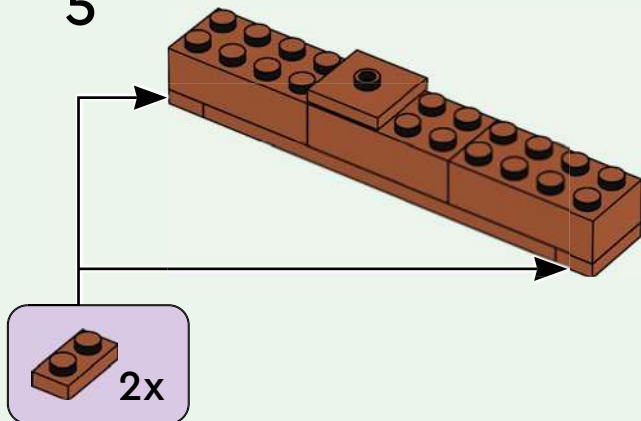

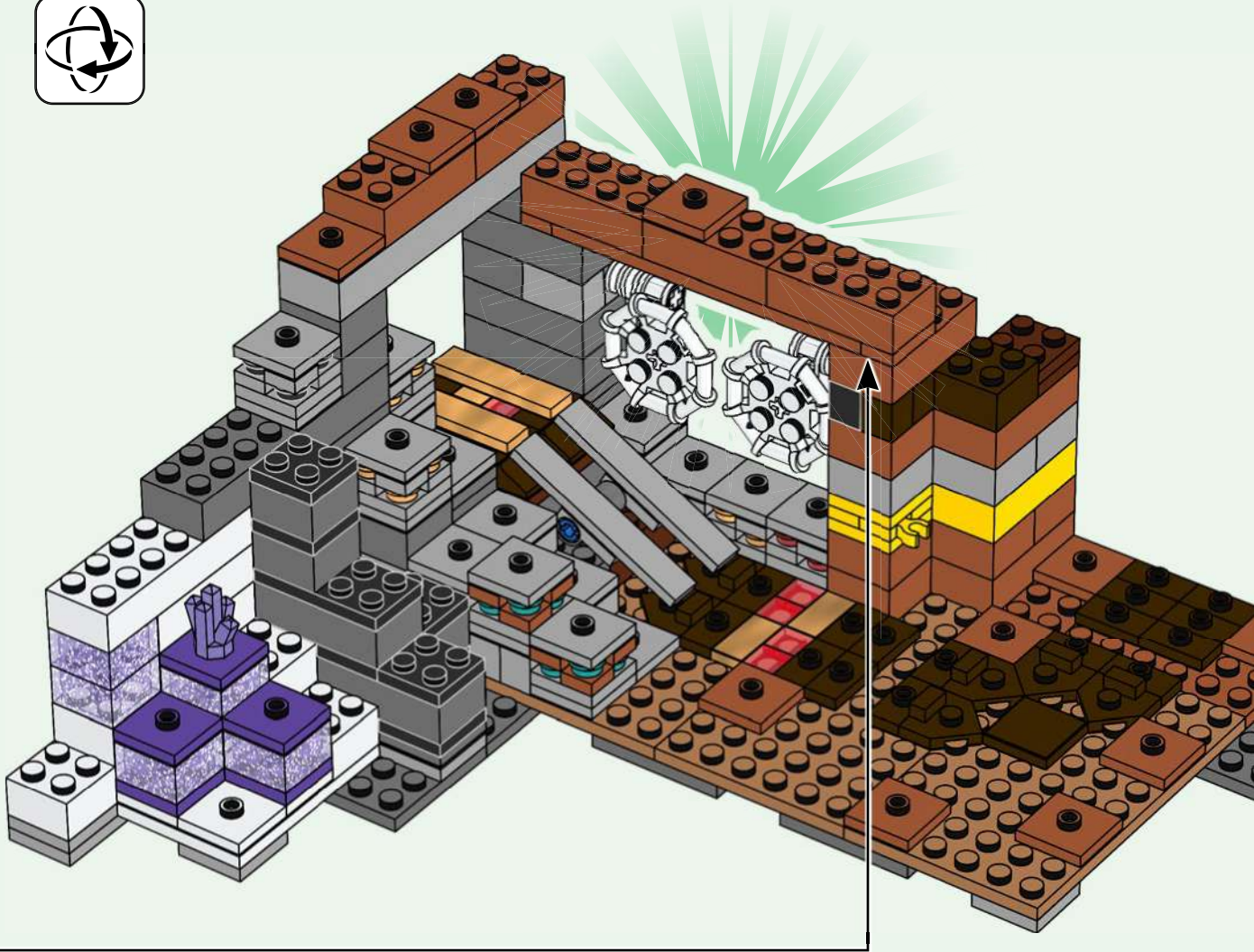





1x



2x

# 82

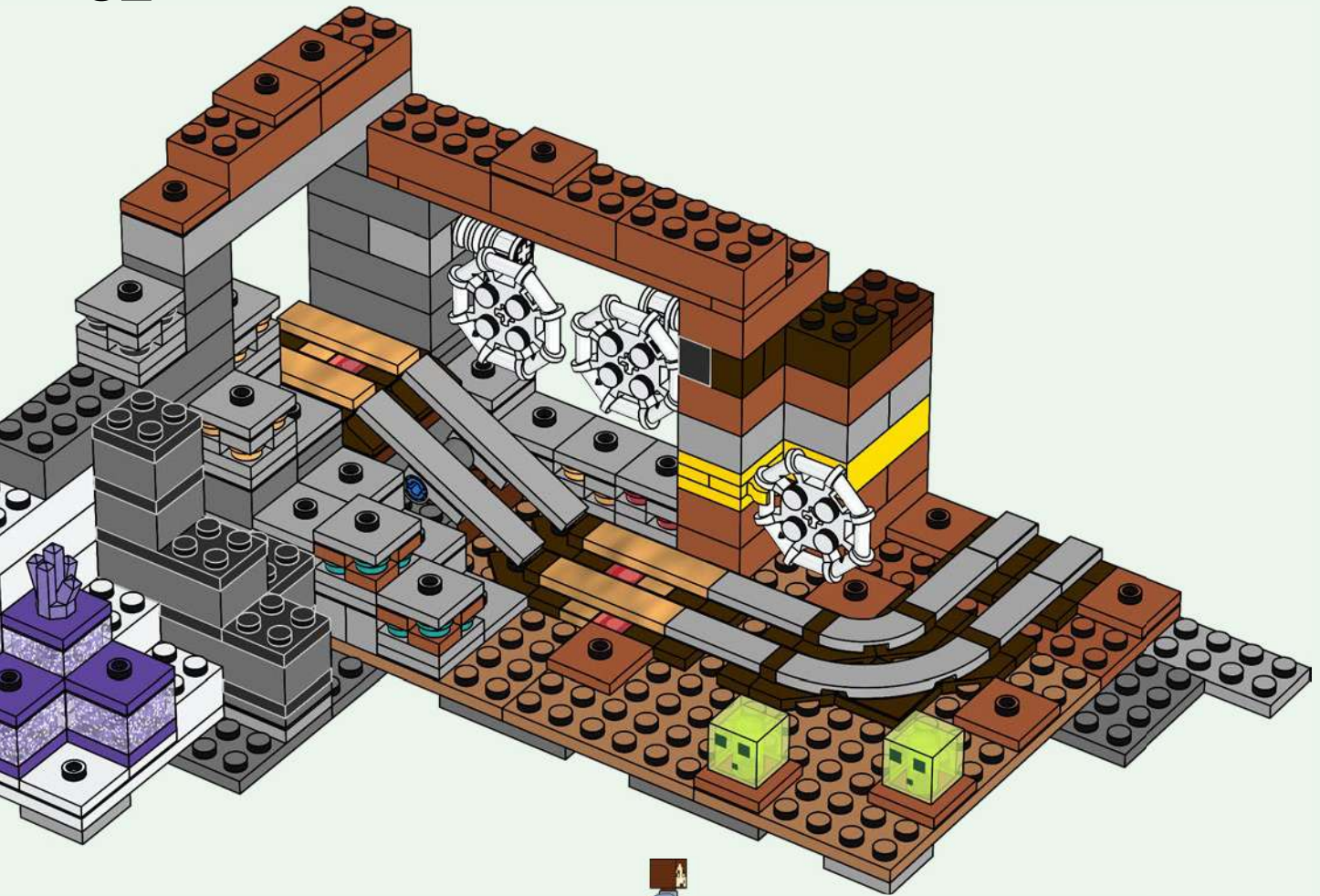

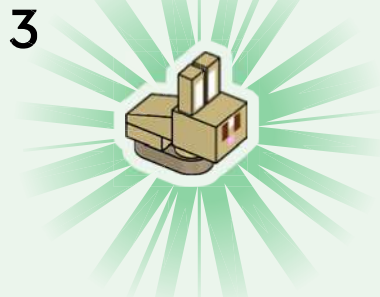
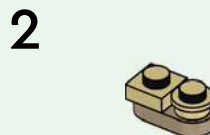
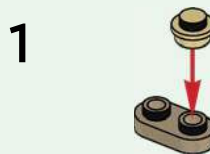
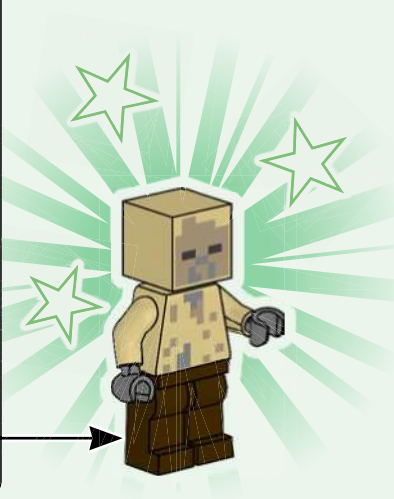
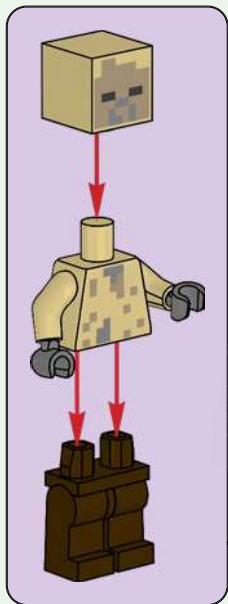
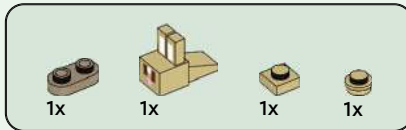

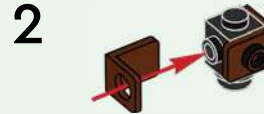
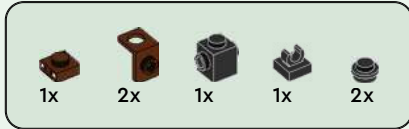
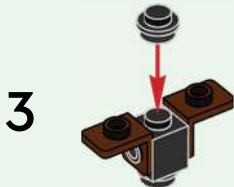

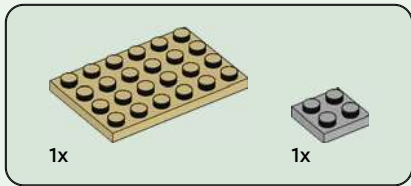

83

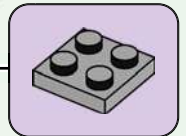
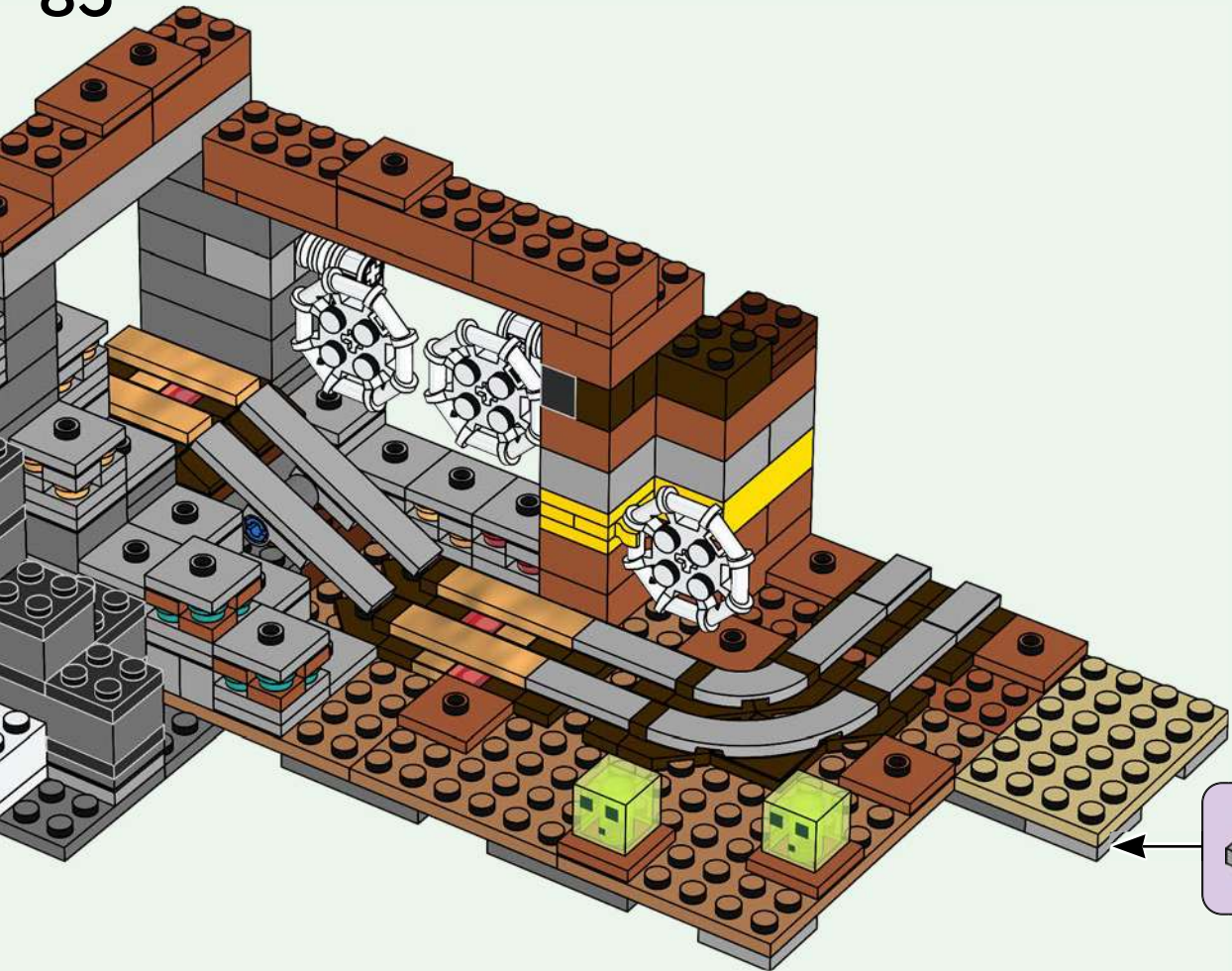

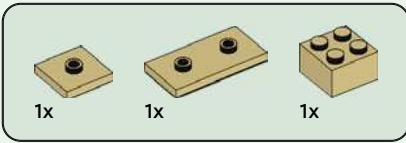

84

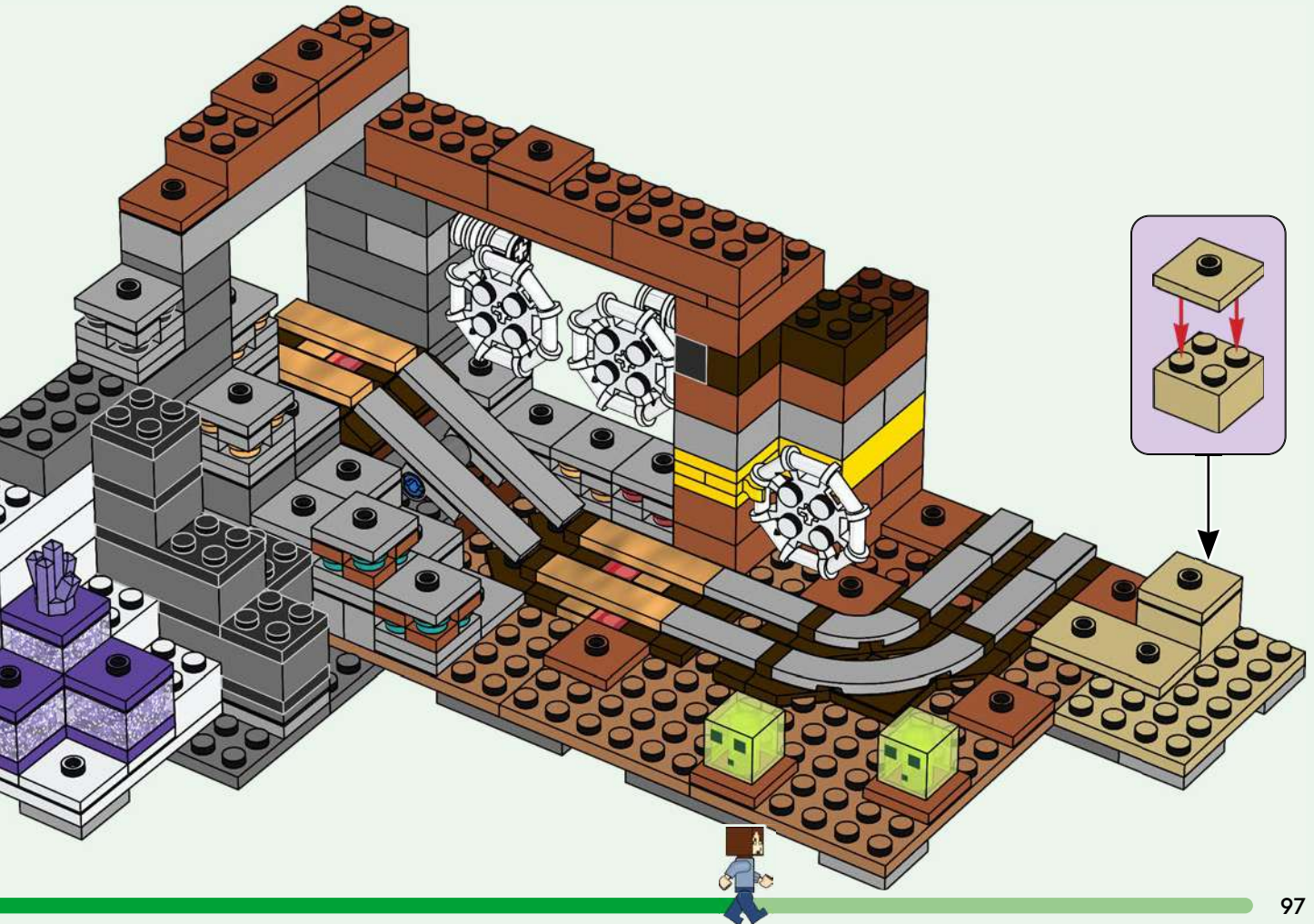

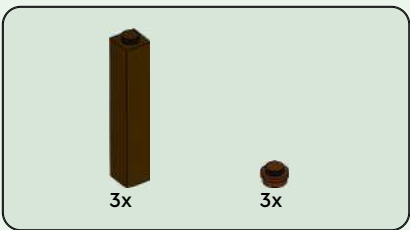

85

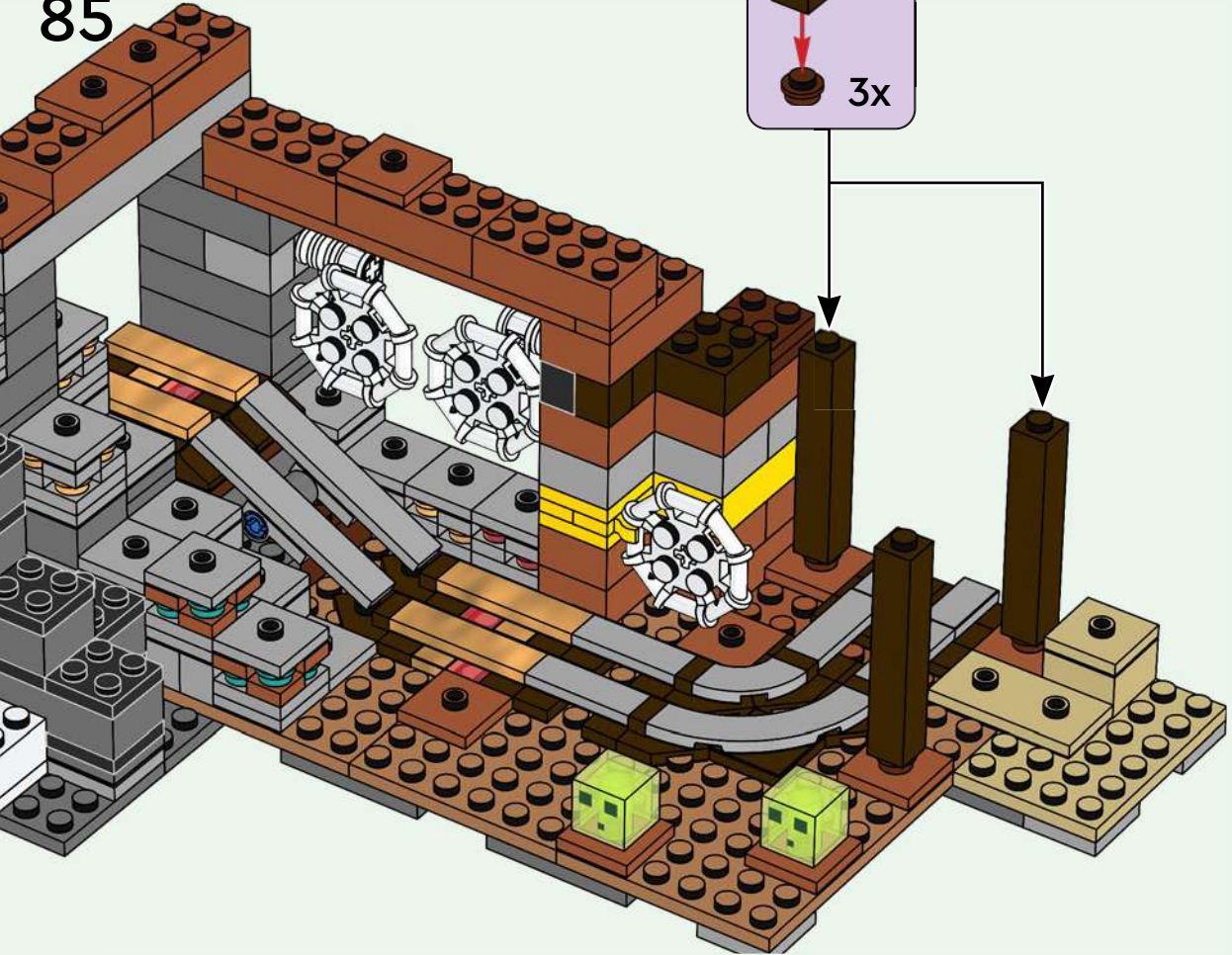
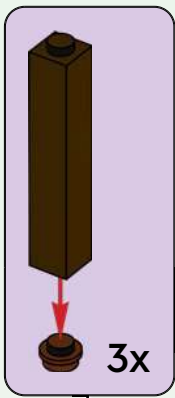

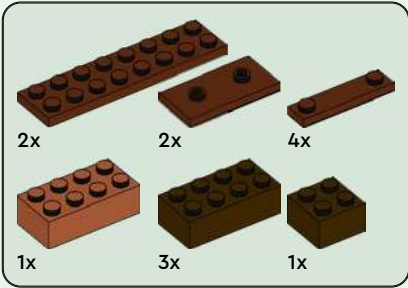
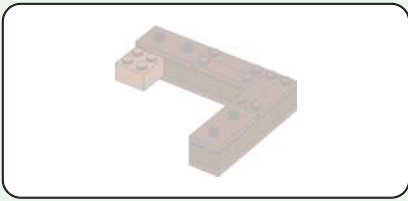

86

1

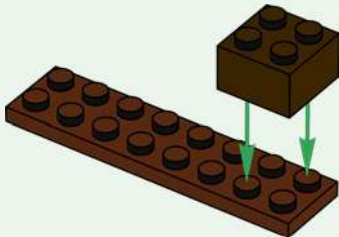

2

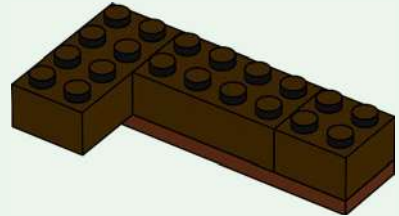

3

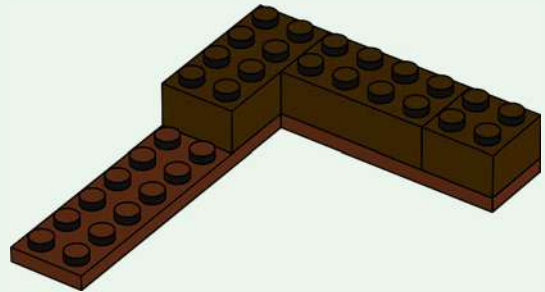

4

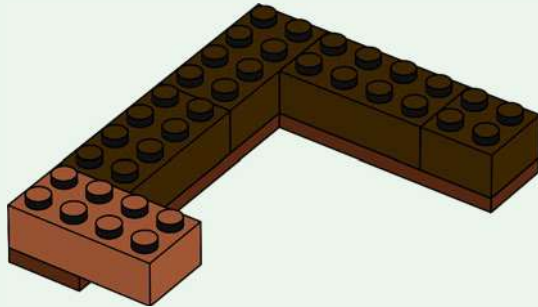

5

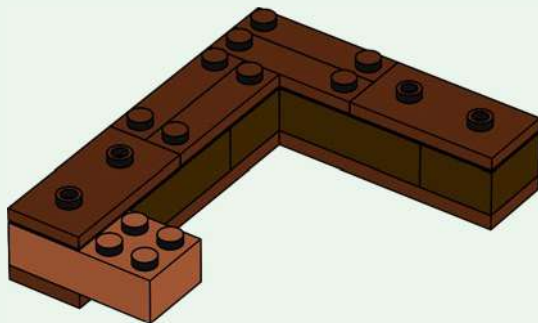

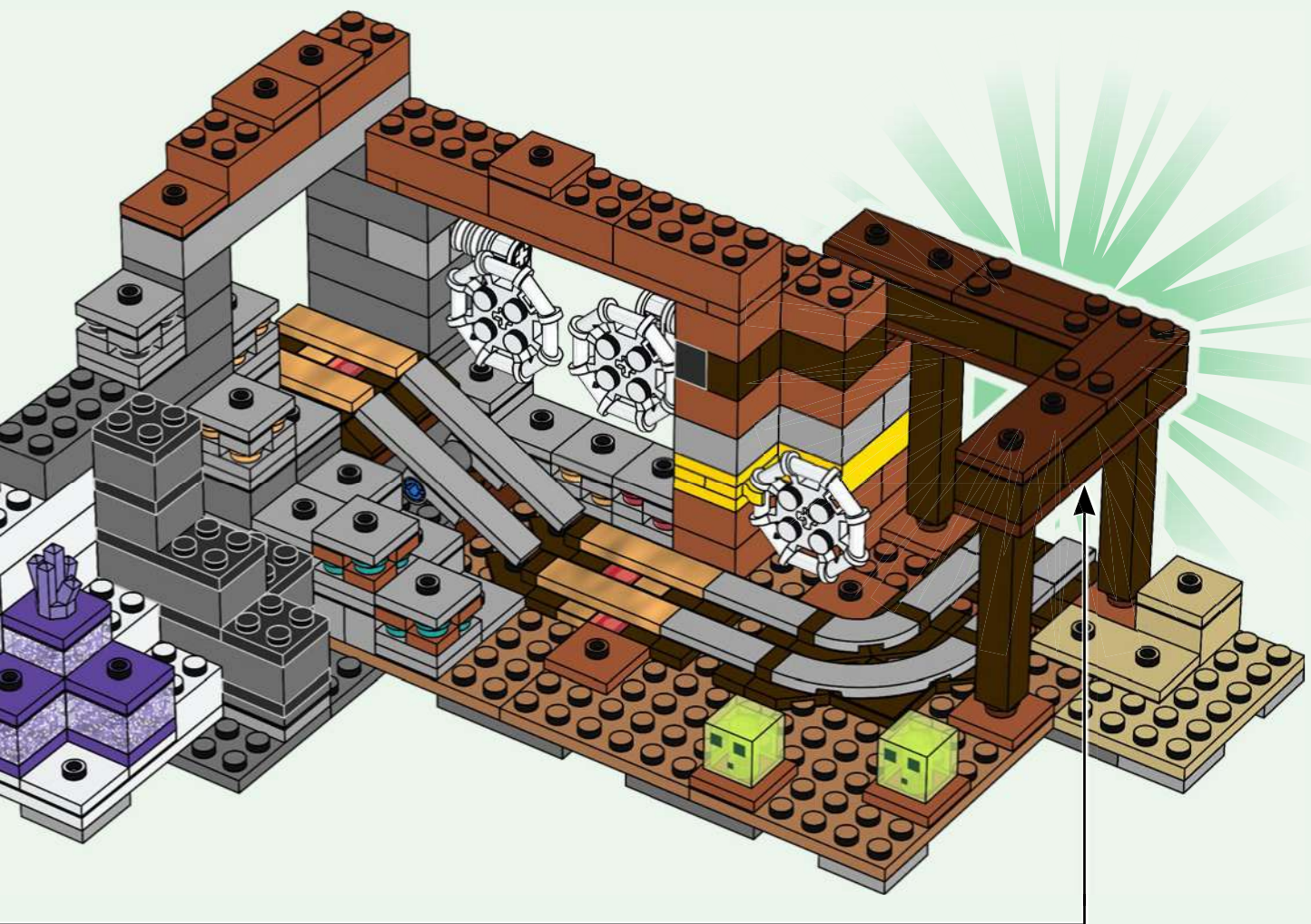

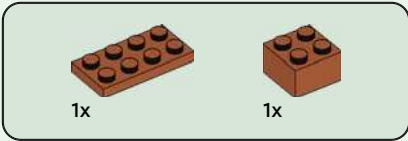

87

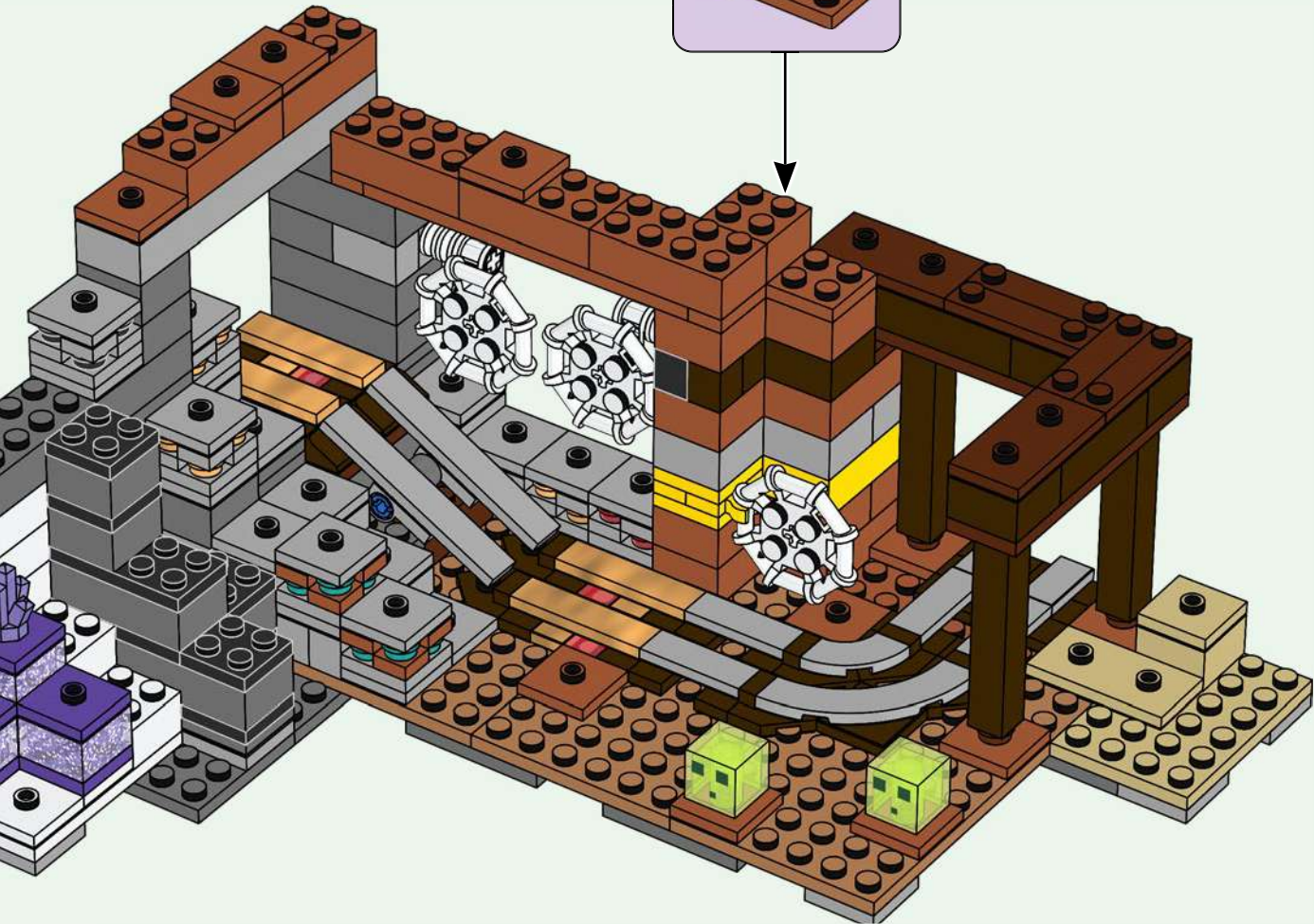
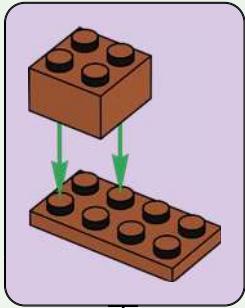

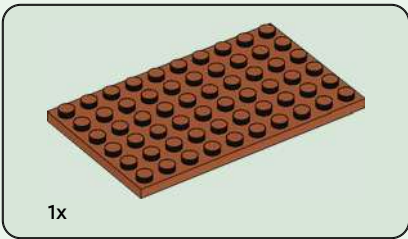

88

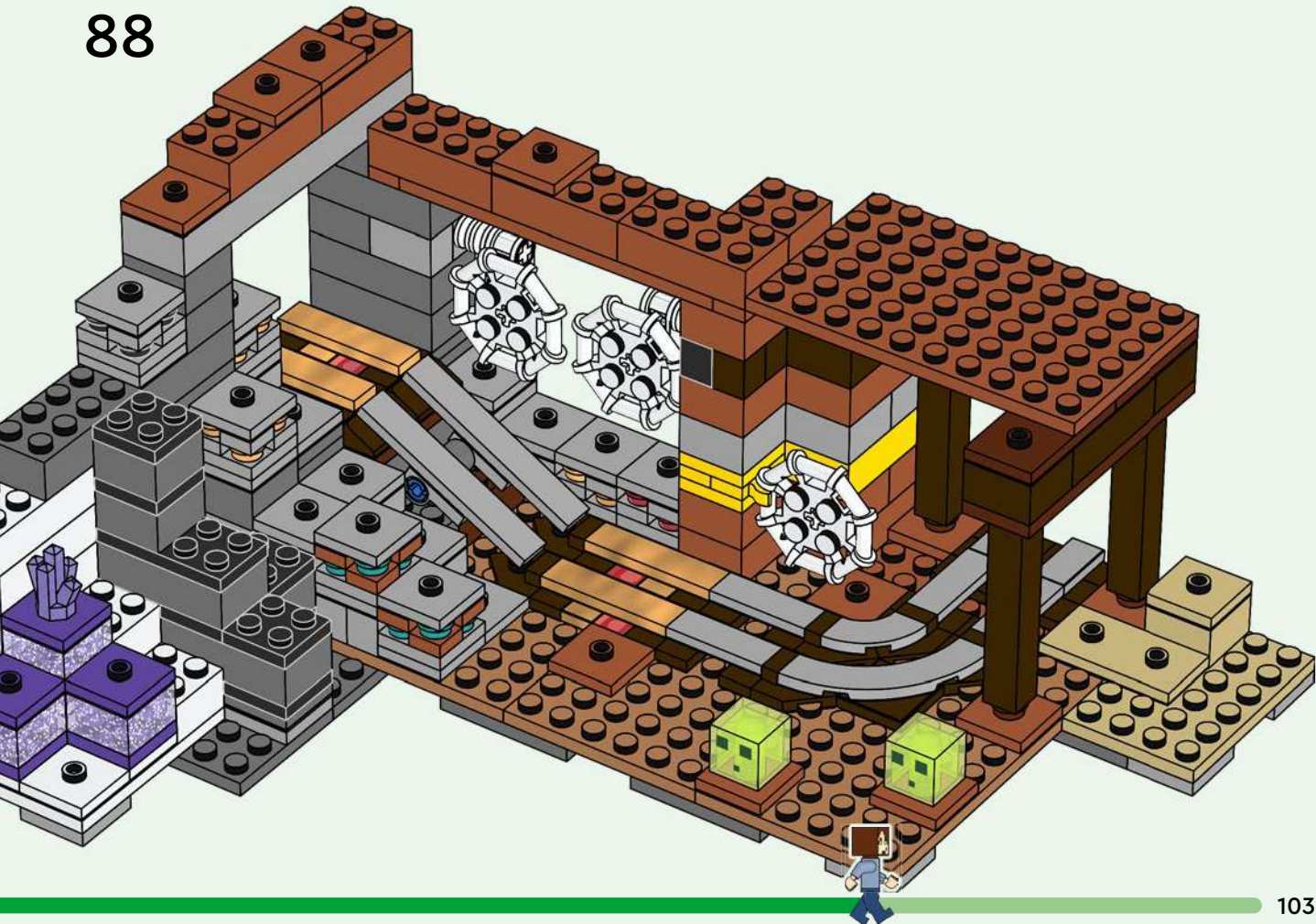

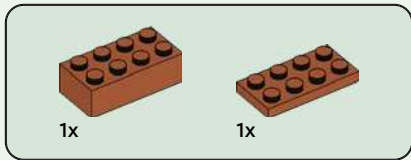

89

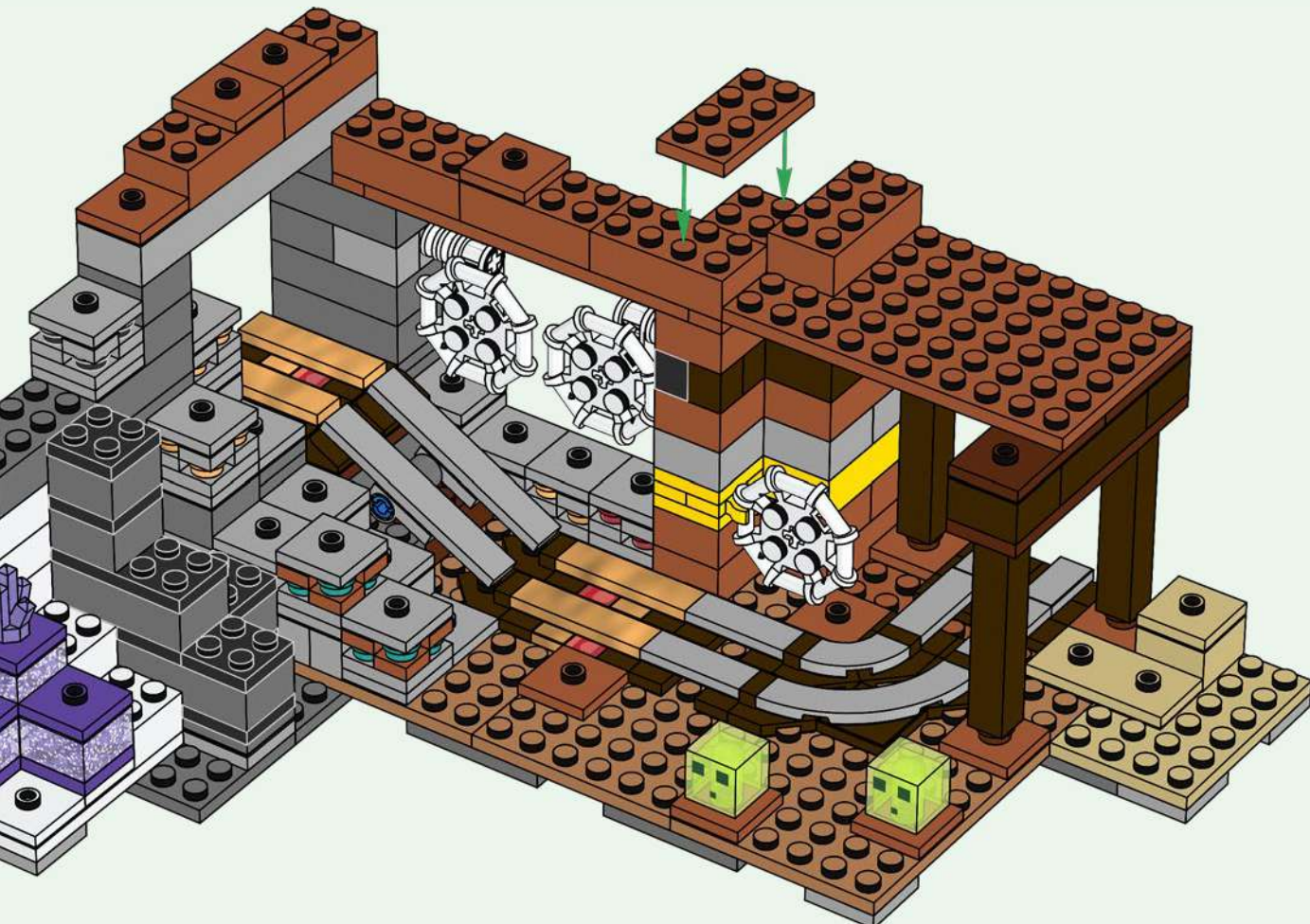

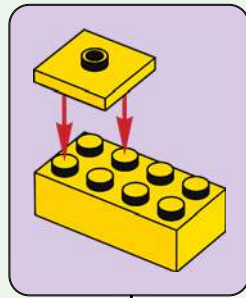
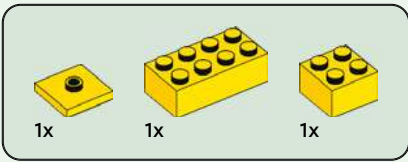

90



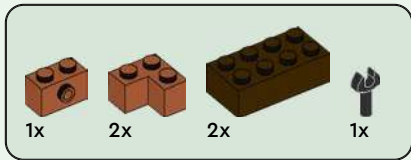

91

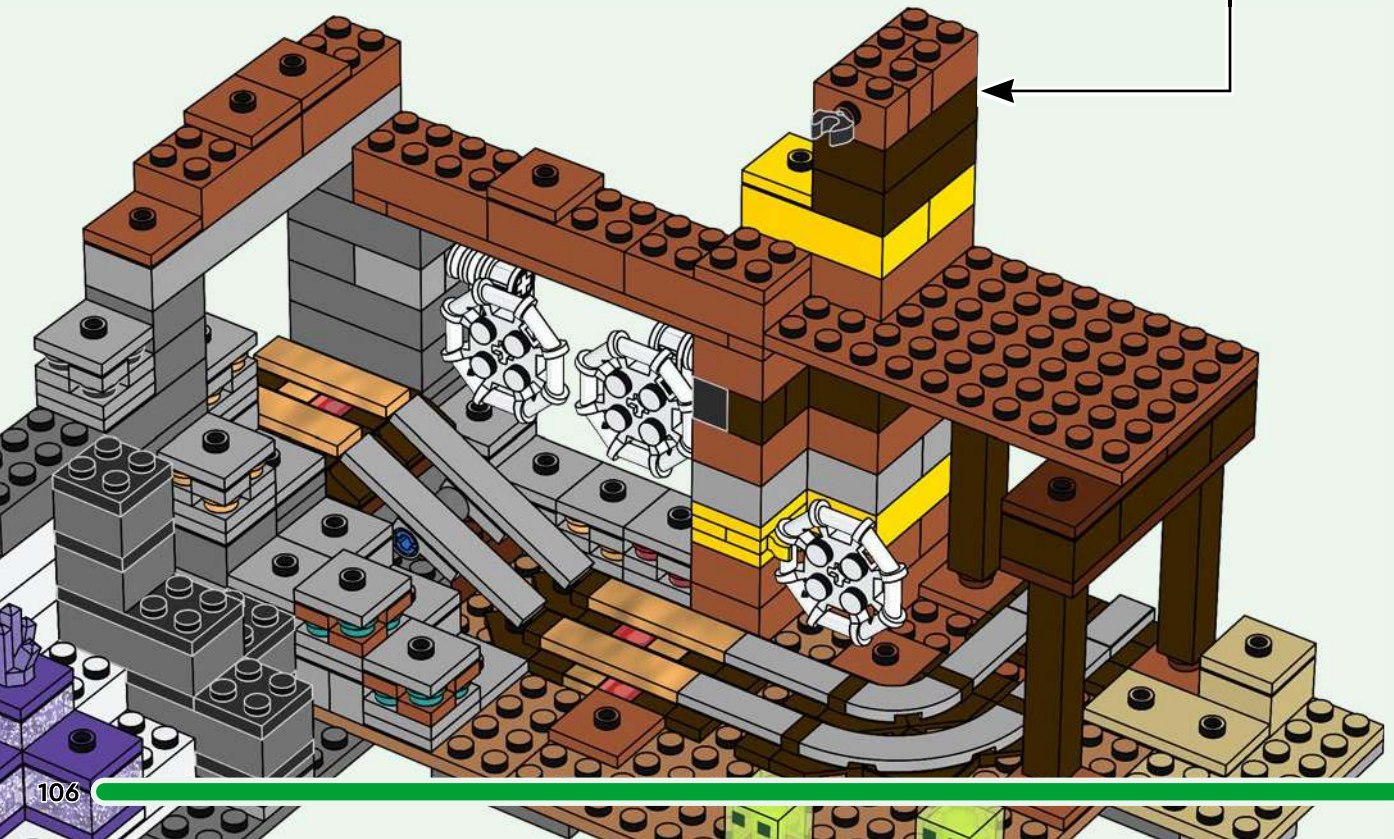
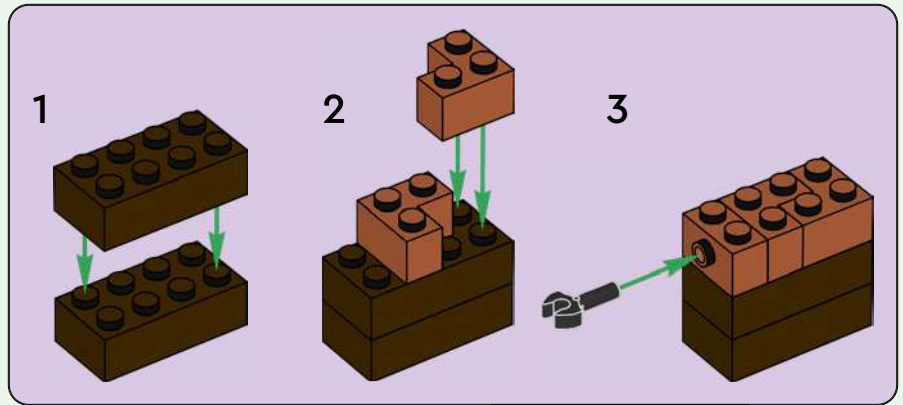

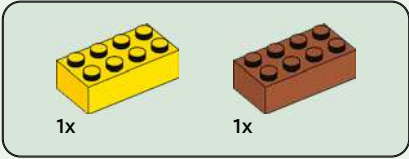
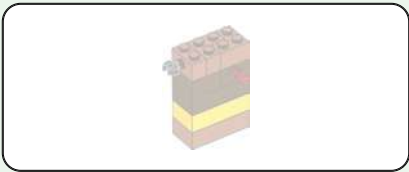

92

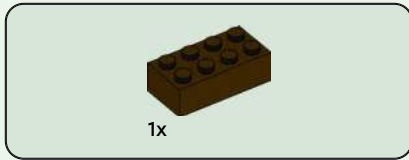
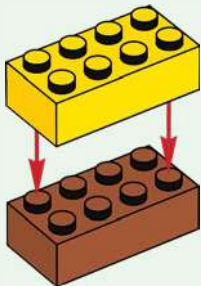

93

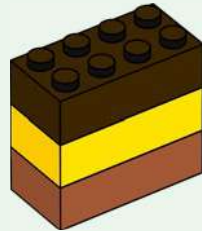

94

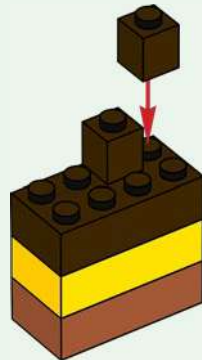



95

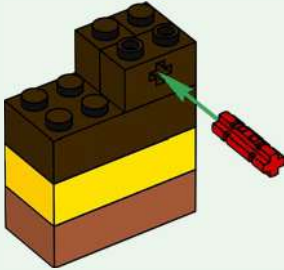

96

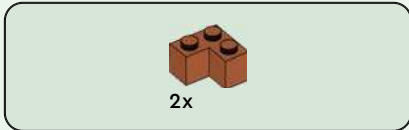

97

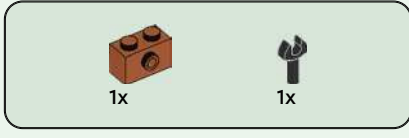

98

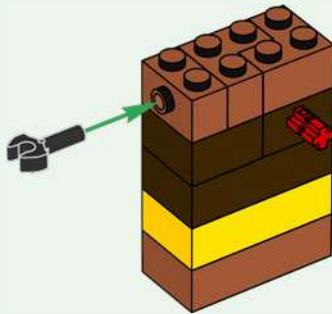

99

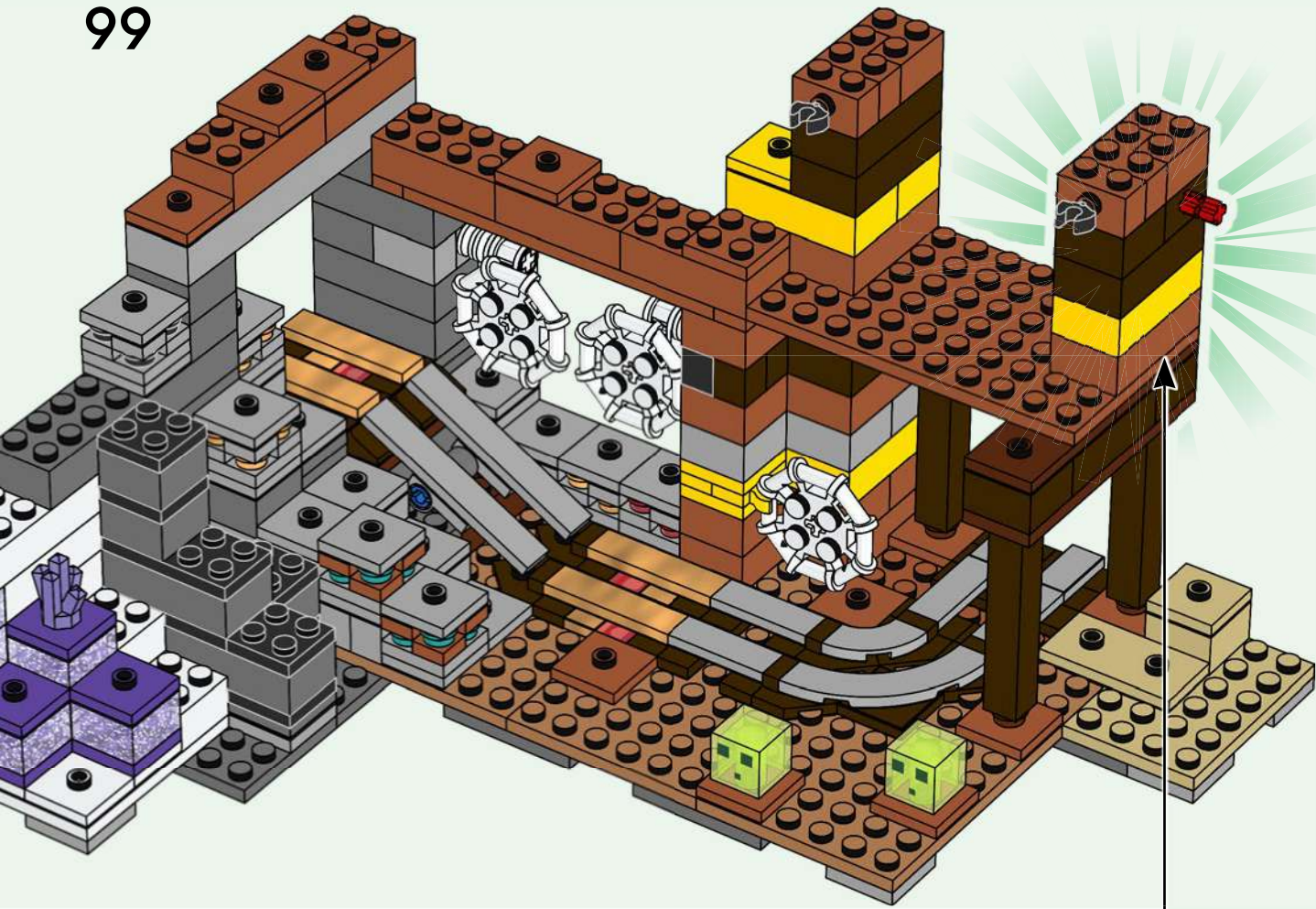

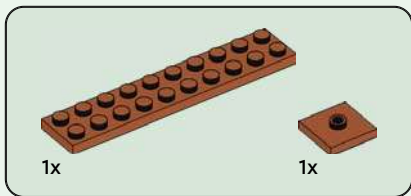

100

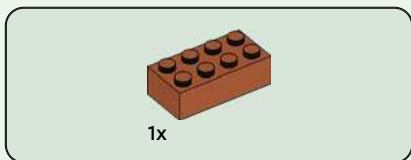
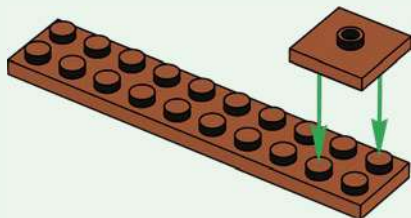

101

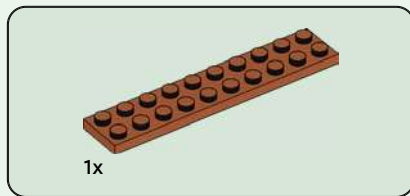
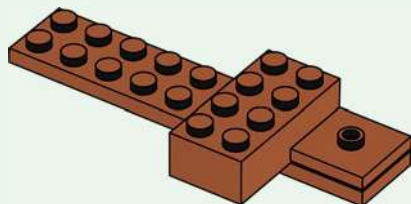

102

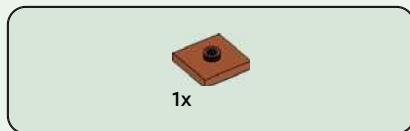
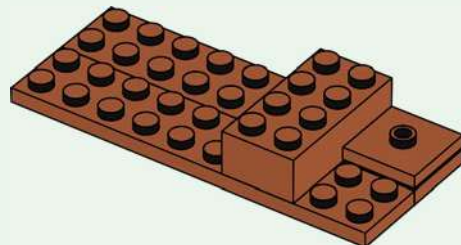

103

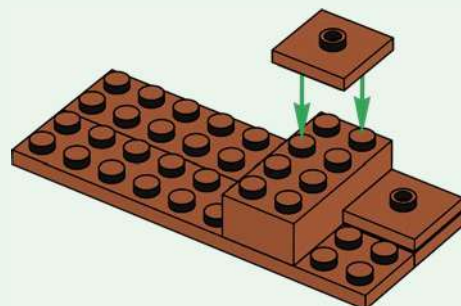



1x

# 104

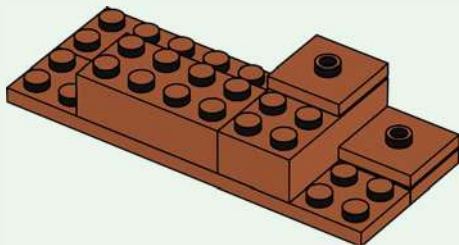

1x



1x

# 105

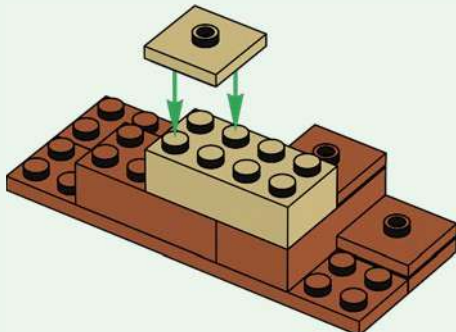

3x

# 106

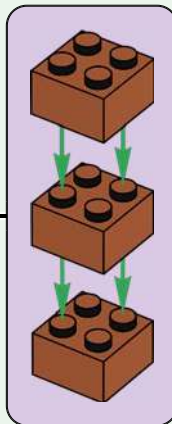
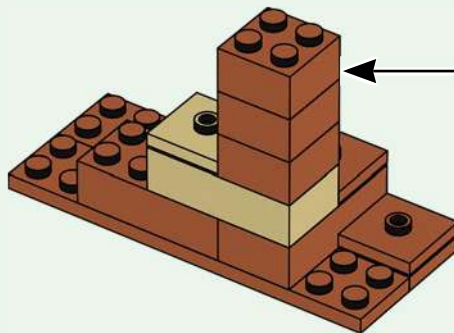

1x

# 107

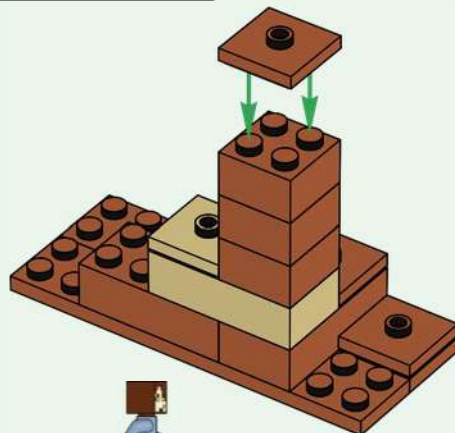

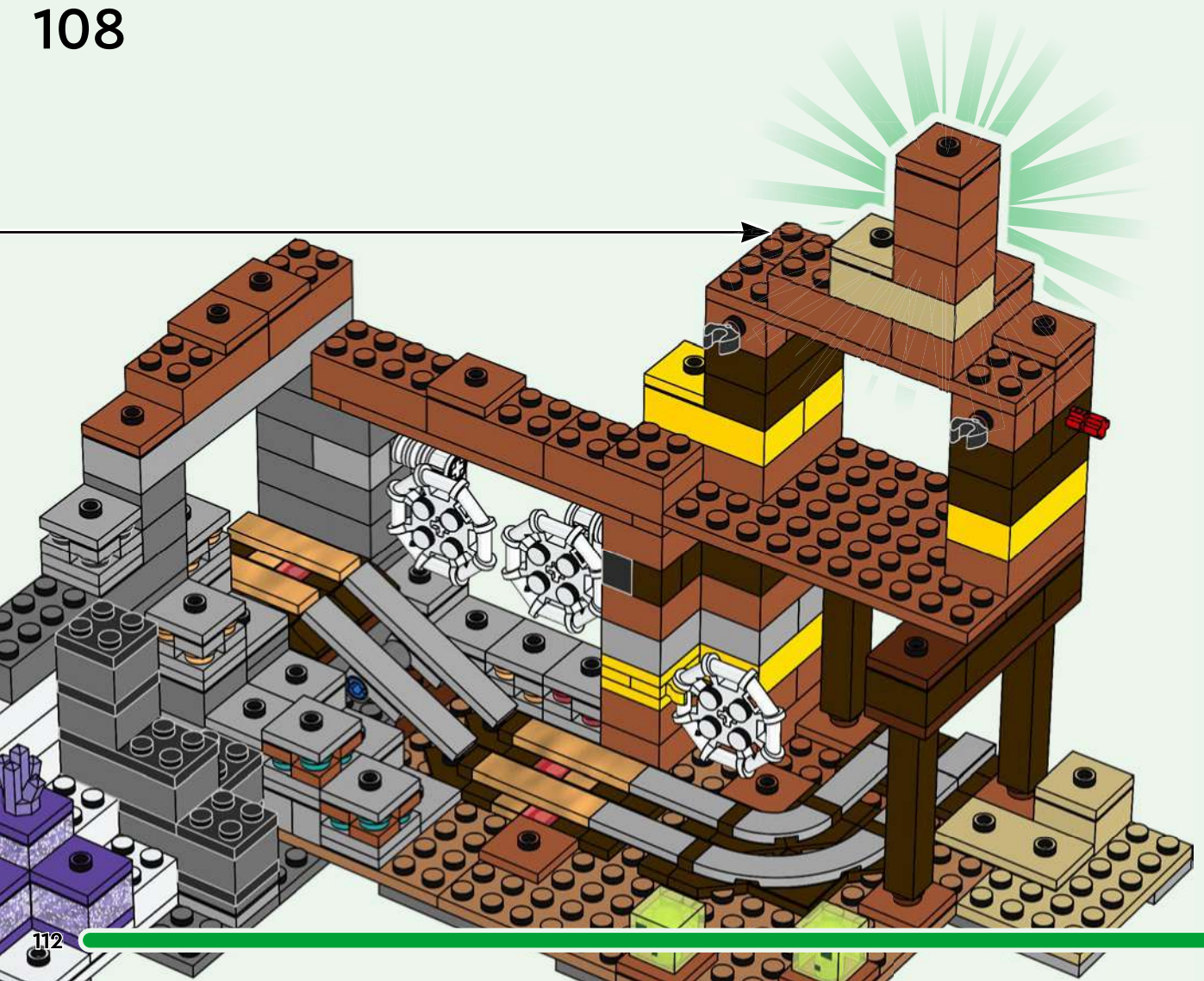



109

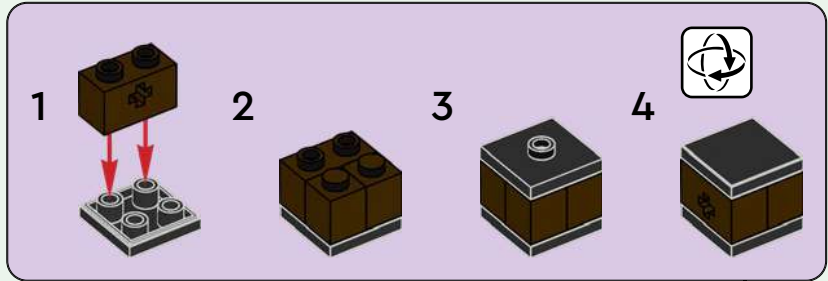



2x



4x



2x



2x



4x

# 110

1

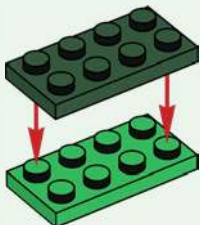

2

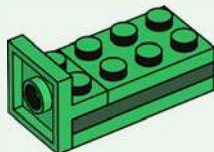

3

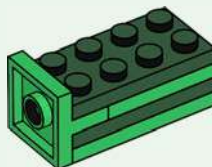

4

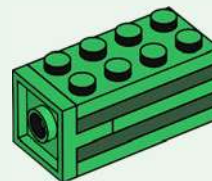

2x

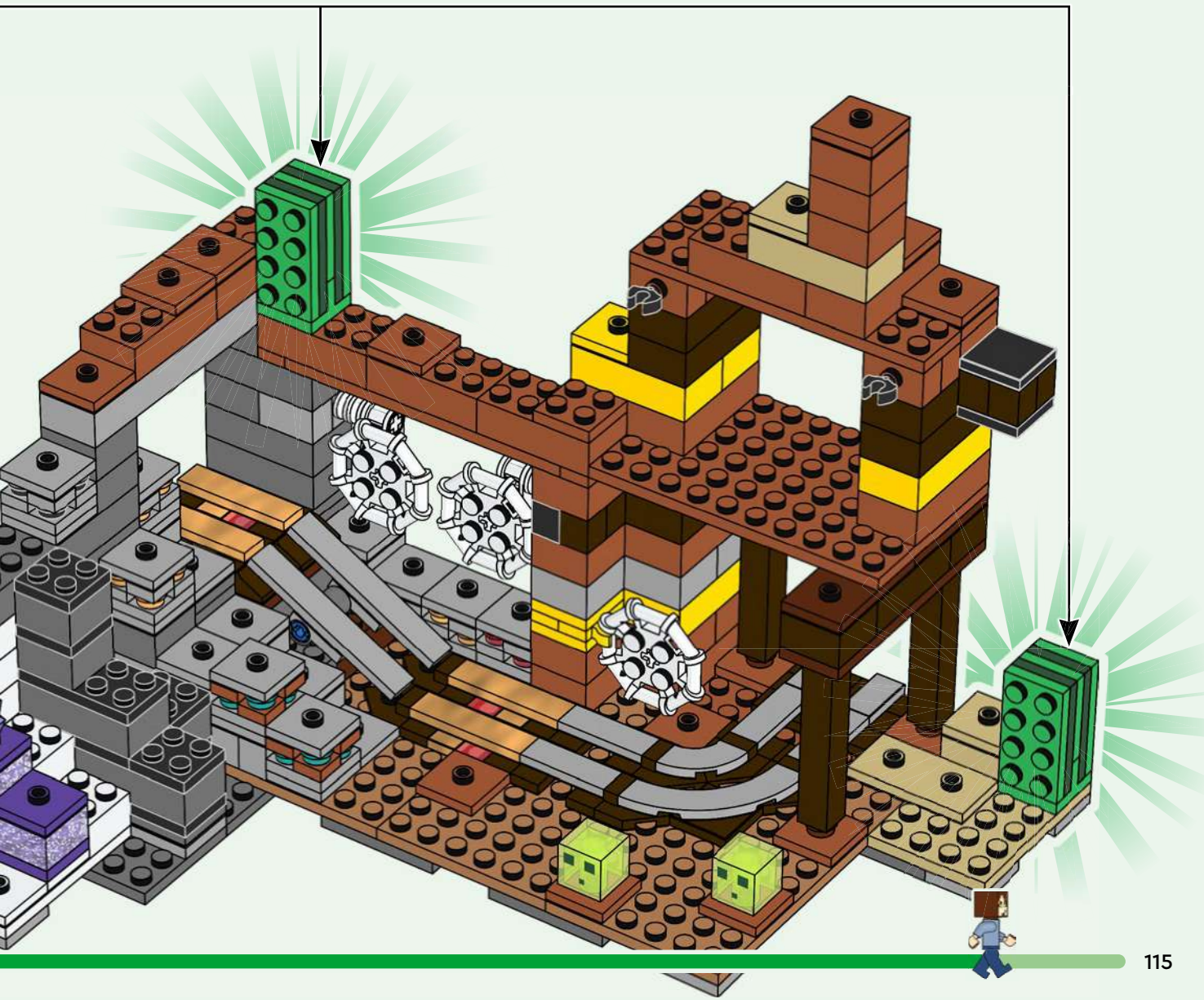



3x

111



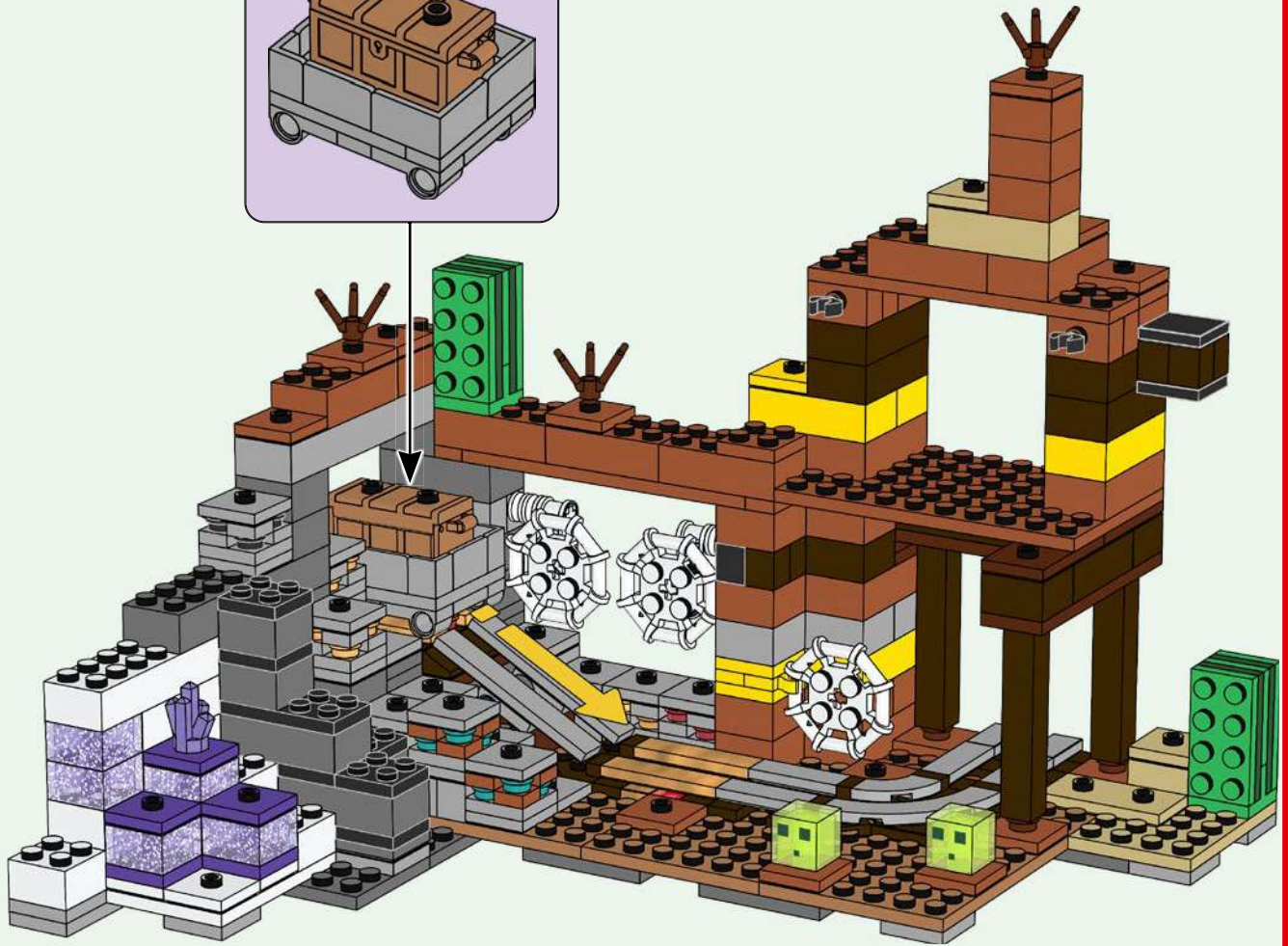
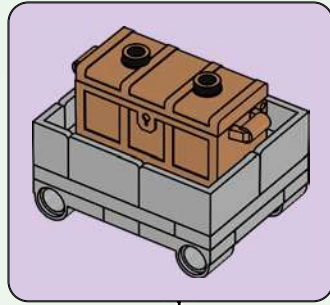



1

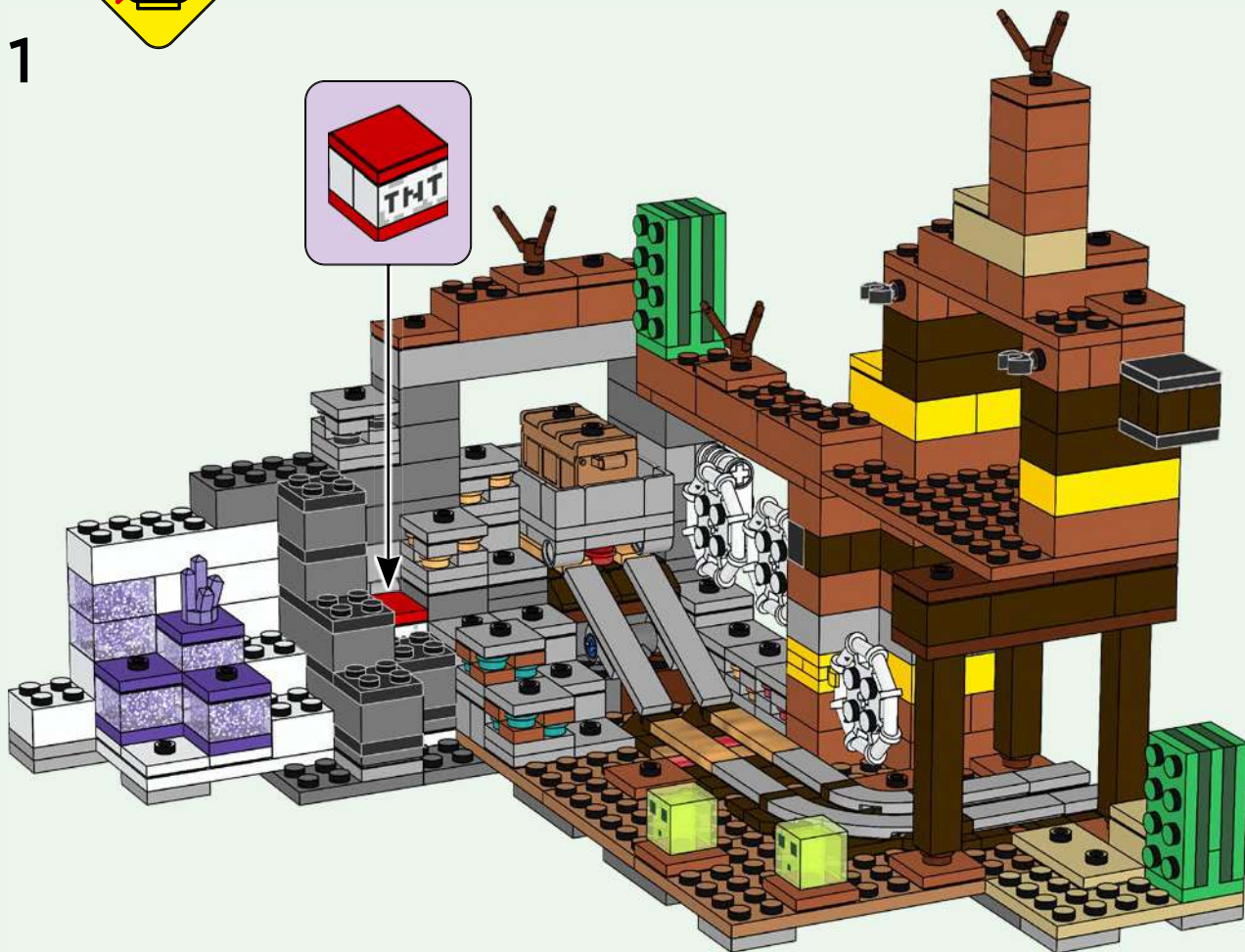
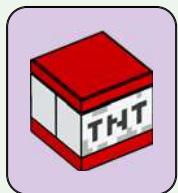

2

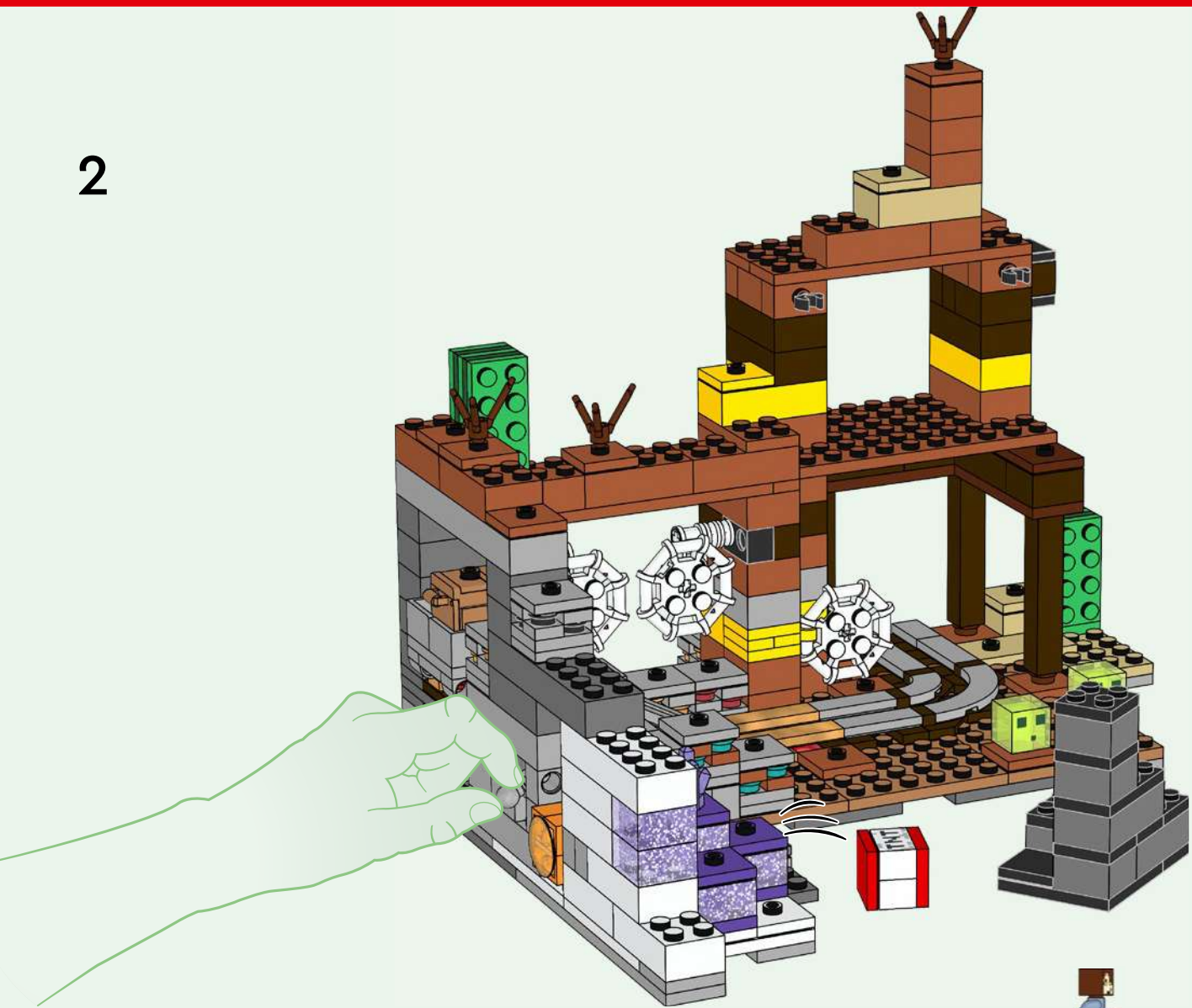

112

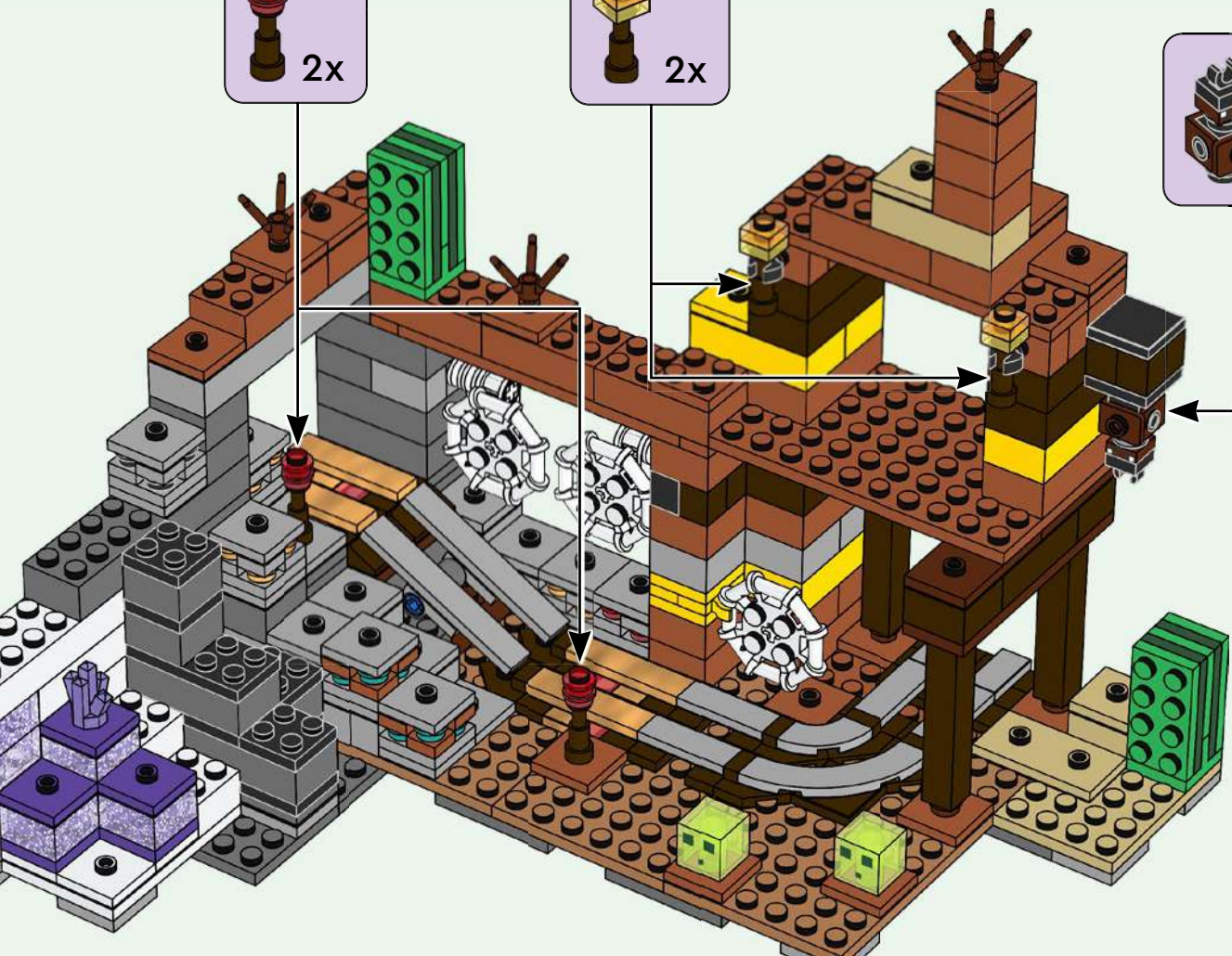

113

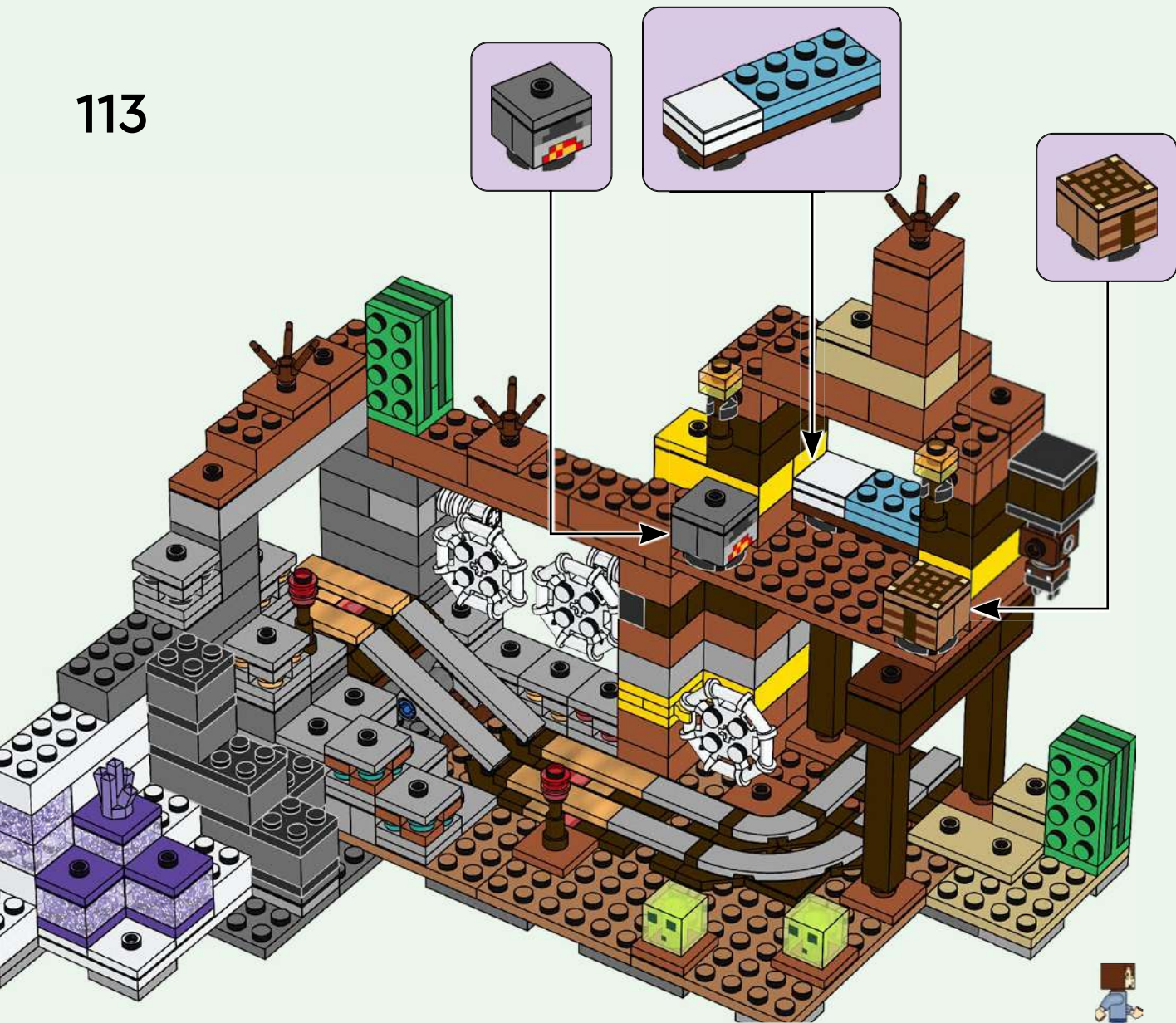





Rebuild  
the  
world™





# MINECRAFT

21263



21261



21262



21264



21259



21260



|               |               |               |                |               |                |               |                |
|---------------|---------------|---------------|----------------|---------------|----------------|---------------|----------------|
| 4x<br>6360263 | 1x<br>4161734 | 8x<br>614126  | 1x<br>306826   | 2x<br>6468067 | 1x<br>4211535  | 4x<br>4211445 | 4x<br>4211483  |
| 2x<br>6097028 | 1x<br>4159553 | 2x<br>6439039 | 4x<br>6416444  | 4x<br>6253417 | 24x<br>4211399 | 1x<br>4211385 | 2x<br>6211969  |
| 2x<br>6330960 | 2x<br>4666579 | 2x<br>4214559 | 1x<br>6438520  | 4x<br>6162485 | 1x<br>6443149  | 2x<br>4211549 | 2x<br>4215513  |
| 2x<br>302201  | 1x<br>6481501 | 2x<br>6210270 | 8x<br>6186012  | 2x<br>306928  | 1x<br>4211807  | 1x<br>6458164 | 2x<br>4211396  |
| 2x<br>302201  | 2x<br>4565387 | 4x<br>403226  | 2x<br>4570877  | 2x<br>6352550 | 1x<br>6268924  | 1x<br>4243797 | 2x<br>6181755  |
| 2x<br>300301  | 1x<br>4114306 | 2x<br>6335388 | 1x<br>4615606  | 2x<br>302128  | 1x<br>6313114  | 1x<br>4211452 | 3x<br>6146223  |
| 4x<br>6126046 | 1x<br>6468465 | 5x<br>302226  | 14x<br>6315197 | 1x<br>6192875 | 2x<br>4617170  | 1x<br>4211452 | 6x<br>6186633  |
| 1x<br>306801  | 1x<br>6488981 | 1x<br>3200026 | 6x<br>6212081  | 4x<br>302028  | 2x<br>4211398  | 5x<br>4211795 | 23x<br>6126082 |
| 4x<br>6126046 | 1x<br>4114319 | 4x<br>6336989 | 16x<br>6487946 | 1x<br>242024  | 1x<br>4211469  | 1x<br>4211795 | 1x<br>6163990  |
| 1x<br>306801  | 1x<br>6294227 | 2x<br>4225201 | 2x<br>4535928  | 1x<br>6348065 | 1x<br>4211470  | 1x<br>4211521 | 4x<br>4558169  |
| 2x<br>6289797 | 1x<br>4114001 | 1x<br>4565323 | 2x<br>6426644  | 1x<br>6126050 | 4x<br>4211541  | 1x<br>4617862 | 2x<br>4211387  |
| 3x<br>6009016 | 1x<br>4142865 | 1x<br>6013867 | 3x<br>6351327  | 2x<br>302224  | 5x<br>4211388  | 1x<br>4211360 | 1x<br>4211349  |
| 6x<br>300101  | 1x<br>306821  | 2x<br>302026  | 2x<br>6426644  | 2x<br>300324  | 2x<br>4211414  | 1x<br>4211360 | 1x<br>4211349  |
| 1x<br>4181142 | 1x<br>302221  | 1x<br>4243819 | 1x<br>6263971  | 3x<br>300124  | 1x<br>6481489  | 1x<br>4211486 |                |
| 2x<br>4144012 |               |               |                |               | 17x<br>4211397 |               |                |

2x  
6252040

1x  
6240550

1x  
6171727

3x  
4216581

3x  
6269973

2x  
4216695

1x  
4211190

4x  
6257604

2x  
6307618

1x  
6365882

1x  
4211247

2x  
4211211

1x  
6135014

1x  
6216860

1x  
6216862

9x  
4211060

2x  
4211055

1x  
6126083

1x  
4521187

1x  
4211103

8x  
4211085

1x  
4560184

5x  
4211065

7x  
4243831

1x  
6187438

1x  
4211061

1x  
4210678

2x  
6195336

4x  
6170809

1x  
6481485

3x  
6047422

3x  
6446090

1x  
6350506

1x  
6093629

2x  
4655256

2x  
6335370

16x  
4523159

4x  
6107197

2x  
6207933

4x  
6478933

8x  
6325978

12x  
6208450

8x  
6254248

2x  
6252045

1x  
6488731

2x  
6097024

1x  
6097003

1x  
6394960

1x  
6102984

3x  
6482273

3x  
4528981

1x  
4162916

1x  
6481490

1x  
4205004

1x  
4667595

2x  
6393309

1x  
6068996

1x  
4121739

1x  
6212079

1x  
4118828

1x  
6240515

6x  
6226437

3x  
6381675

2x  
6127366

1x  
4529672

6x  
6487948

20x  
6404033

2x  
6272144

4x  
4538950

1x  
6179803

2x  
6092677

7x  
6353072

1x  
6442192

1x  
6299413

5x  
6487947

1x  
6231386

2x  
4598955

4x  
4586057

 [LEGO.com/service](https://www.LEGO.com/service)



YOU COULD **WIN**



Scan this QR code or go to **LEGO.COM/PRODUCTFEEDBACK** and give us your short feedback about this LEGO® set for a chance to win a cool LEGO prize.

Terms and Conditions apply\*

**EN: YOU COULD WIN.** Terms and Conditions apply\* **DE: Du könntest GEWINNEN.** Es gelten die Teilnahmebedingungen\* **FR: Tu pourrais GAGNER.** Des conditions s'appliquent\* **IT: Potresti VINCERE tu.** Termini e condizioni sono applicabili\* **ES: Puedes GANAR.** Aplican términos y condiciones\* **PT: Poderá GANHAR.** Aplicam-se termos e condições\* **ZH: 轻松获奖. 条款和条件适用\*** **PL: Szansa na WYGRANĄ.** Obowiązują warunki korzystania\* **CS: Máte šanci VYHRÁT.** Platí všeobecné smluvní podmínky\* **SK: Máte šancu VYHRAŤ.** Platia všeobecné zmluvné podmienky\* **HU: TE IS NYERHETSZ.** Felhasználási feltételek érvényesek\* **RO: Ai putea CÂȘTIGA.** Se aplică termeni și condiții\* **BG: Можете да СПЕЧЕЛИТЕ.** Има определени правила и условия\* **LV: Tu vari LAIMĒT.** Ir spēkā noteikumi un nosacījumi.\* **ET: Sul on võimalus VÕITA.** Kehtivad tingimused\* **LT: Jūs galite LAIMĖTI.** Taikomos sąlygos\*

\*[LEGO.com/productfeedback-terms](https://www.lego.com/productfeedback-terms)

LEGO and the LEGO logo are trademarks of the LEGO Group. ©2024 The LEGO Group.

© 2024 Mojang AB. All Rights Reserved. Minecraft, the Minecraft logo, the Mojang Studios logo and the Creeper logo are trademarks of the Microsoft group of companies.

6520680