

ORIONE

frullatori
blenders



ORIONE Q VV

BPA
Free



ORIONE T VV

- Frullatori professionali nati dalle specifiche esigenze del bar, ristorante, mensa, ecc.
- Corpo macchina in alluminio estruso e fianchi in ABS.
- Sistema di tenuta a membrana per prevenire l'ingresso di liquidi all'interno della macchina.
- Potente motore con ventilazione forzata, per un utilizzo prolungato e una maggiore durata.
- Microinterruttore magnetico di sicurezza sul coperchio bicchiere senza posizione obbligatoria.
- Comandi a membrana siliconica con pulsante ON, OFF Pulse e dispositivo NVR.
- Variatore di velocità.
- Coperchio bicchiere in gomma con tappo per l'aggiunta di ingredienti.
- Corpo mozzo di trasmissione in acciaio inox, facilmente separabile dal corpo bicchiere per una facile pulizia.
- Albero coltelli supportato da cuscinetti a sfere per prevenire il surriscaldamento e garantire una lunga durata.
- Trascinatore a stella in acciaio sinterizzato ad alta resistenza.
- Coltello a 4 razze ricavato da un unico stampaggio in acciaio da coltelleria temperato adatto anche per tritare ghiaccio.

MODELLO Q **Q**

- Bicchiere quadro da 2 litri in Tritan (BPA Free), graduato in litri, galloni UK e USA.
- Il bicchiere quadro è stato sviluppato per lavorare al meglio con grandi quantità di ghiaccio anche a secco, pratico e funzionale, si può versare il prodotto su 3 diverse direzioni.
- Ideale per la preparazione di frozen drink o smoothies con sciroppi e concentrati.

MODELLO T **T**

- Bicchiere tondo da 2 litri in Tritan (BPA Free), graduato in litri, galloni UK e USA, ideale per frullati e frozen.
- Optional: bicchiere inox da 2 litri, ideale per frullati e frozen.

ALTRI MODELLI Q/T

- Modello 2 bicchieri in Tritan o inox opzionale.
- Modello Timer: timer a regolazione manuale e spegnimento automatico della macchina.
- Modello Plus: versione elettronica con 9 programmi di lavorazione preimpostati.

MODELLO 5 LITRI

- Corpo macchina in acciaio inox.
- Bicchiere tondo in acciaio inox da 5 litri.
- Coperchio bicchiere in PE e guarnizione di tenuta, bloccato con cerniere, tappo per l'aggiunta di ingredienti.
- Albero coltelli supportato da boccole in bronzo.
- Trascinatore metallico con denti contrapposti ideale per resistere alle lavorazioni con prodotti caldi.





- Professional mixer designed to cater for specific requirements of bars, restaurants, cafeterias, etc.
- Extruded aluminium machine body and sides in ABS.
- Membrane sealing system to prevent fluids from entering the machine.
- Powerful motor with forced ventilation, for prolonged use and enhanced durability.
- Magnetic safety micro-switch on glass lid without forced position.
- Siliconic membrane controls with ON, OFF Pulse button and NVR device.
- Speed control.
- Glass lid in rubber with plug for adding ingredients.
- Stainless steel transmission hub body; can be easily separated from the glass body for easy cleaning.
- Cutters shaft supported by ball bearings to prevent overheating and to guarantee enhanced durability.
- Star drive in high-resistance sintered steel.
- 4-Spoke cutter obtained from a single pressing of hardened steel for blades also suitable for crushing ice.

BPA Free



ORIONE 2T VV

Q MODEL

- 2 litre square glass in Tritan (BPA Free), graduated in litres, UK and U.S. gallons.
- Very practical square glass, with possibility of pouring in 3 different directions, ideal in the preparation of frozen drinks, Smoothies with syrups and concentrates.
- Ideal in the preparation of frozen drinks, Smoothies with syrups and concentrates.

ORIONE 2Q VV

T MODEL

- 2 litre round glass in Tritan, graduated in litres, UK and U.S. gallons, ideal for shakes and frozen drinks.
- Optional: round 2-litre glass, made in stainless steel, ideal in the preparation of shakes and frozen drinks.

OTHER MODELS Q/T

- 2 glass version, for T/Q models, in Tritan (BPA Free) or stainless steel optional.
- Orione Timer: manual adjustment timer and automatic machine switch-off.
- Orione Plus: electronic version with 9 pre-set processing programs.

5 LITERS MODEL

- Machine body in stainless steel.
- 5-Litre round glass in stainless steel.
- Glass lid in PE and sealer, locked with hinges and with plug for adding ingredients.
- Cutters shaft supported by bronze bushes.
- Metal driver with opposing teeth, ideal to withstand processing of hot products.



ORIONE FIVE





Bicchieri in Tritan (BPA Free)
Glasses in Tritan (BPA Free)



Bicchieri tondo e quadro intercambiabili
Interchangeable round and square glasses



Lame in acciaio da coltelleria bicchiere tondo
Stainless steel blades for round glass



Lame in acciaio da coltelleria bicchiere quadro
Stainless steel blades for square glass



Bicchieri intercambiabili facilmente smontabili per la pulizia
Disassembled and interchangeable glasses, easy to cleaning



Bicchieri quadri impilabili
Stackable square glass

Optionals



Applicazione frappè
Milkshakers application



Bicchiere tondo inox
S/steel round glass

ORIONE - ORIONE FIVE



Comandi VV
VV controls









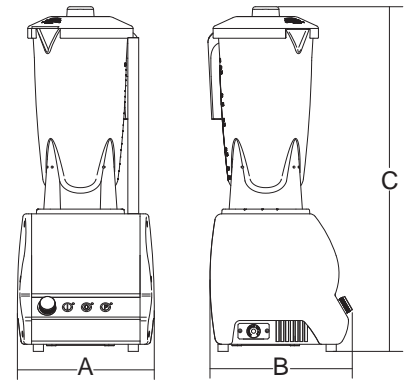



Comandi Timer VV
Timer VV controls



Comandi Plus VV
Plus VV controls



										
	watt/Hp		r.p.m.	lt	mm	mm	mm	kg	mm	kg
Orione Q VV	750/1	1ph	8.000 ÷ 16.000	2	202	210	486	5	310x300x530	7
Orione T VV	750/1	1ph	8.000 ÷ 16.000	2	202	210	508	5	310x300x530	7
Orione 2 Q VV	750+750/1+1	1ph	8.000 ÷ 16.000	2 + 2	380	210	486	10	480x300x530	12
Orione 2 T VV	750+750/1+1	1ph	8.000 ÷ 16.000	2+2	380	210	508	10	480x300x530	12
Orione Five VV	750/1	1ph	8.000 ÷ 16.000	5	245	260	540	7	340x330x640	9