



# SEPLUS 51.2V 280AH

## BATTERY PACK SPECIFICATION



DONGGUAN SEPLUS TECHNOLOGY CO., LTD

# CONTENT

1. Introduction .....	3
2. Functions .....	3
3. Specifications .....	5
3.1 Appearance and interface .....	5
3.2 Electrical schematic diagram .....	5
3.3 Parameters .....	6
3.3 Protection parameters .....	7
3.3.1 Individual cell over voltage parameters .....	7
3.3.2 Individual cell low voltage parameters .....	7
3.3.3 Pack over voltage parameters .....	8
3.3.4 Pack low voltage parameters .....	8
3.3.5 Cell high/low temperature(charging) parameters .....	9
3.3.6 Cell high/low temperature(charging) parameters .....	9
3.3.7 Ambient high/low temperature parameters .....	10
3.3.8 MOSFET high/low temperature parameters .....	11
3.3.9 Charging current limiting parameters .....	11
3.3.10 Charging over limiting parameters .....	12
3.3.11 Discharging over limiting parameters .....	12
3.3.12 Transient over limiting parameters .....	13
3.3.13 Short circuit parameters .....	13
3.3.14 Cell balance parameters .....	14
3.3.15 Cell balance parameters .....	14
3.3.16 Other parameters .....	15
4. Communication .....	16
4.1 CAN communication .....	16
4.2 RS485 .....	17
4.3 Parallel .....	18
4.4 DIP switch .....	18
5. Working mode .....	19
5.1 Charging mode .....	19
5.2 Discharging mode .....	19
5.3 Standby mode .....	19
5.4 Power off mode .....	19
5.4.1 Power off .....	19
5.4.2 Awaken .....	19
6. LED indicator .....	21
6.1 LED lights .....	21
6.2 Capacity indicators .....	21
6.3 Lights blinking explanation A .....	21
6.4 Running status indicators .....	22
6.5 Installation and commissioning .....	23
6.6 Installation instructions .....	23
7. Safety precautions .....	24
7.1 Harness connection .....	25
7.2 DIP setting .....	26
8. Package .....	29
9. Safety precaution .....	30

## 1. Introduction

This battery pack System, is applicable both for residential and commercial energy storage system, which is assembled with 3.2V 280Ah lithium iron phosphate cell in 16S1P configuration, and accompany with SEPLoS Smart BMS. Each pack support 16packs in parallel to easily expand capacity. Do not mix parallel the battery packs of different brands or models.

## 2. Functions

- Battery voltage calculation: 16 battery voltage sampling test, deviation  $\pm 20\text{mV}$
- Battery and ambient temperature detection: 4 battery temperature sensors, 1 ambient temperature sensor, 1 MOS temperature sensor, deviation  $\pm 2\text{ }^{\circ}\text{C}$ .
- Battery capacity and cycle times: complete a complete charging, discharging cycle to set the actual capacity. Monitor the remaining capacity of the battery with the capacity estimation accuracy within 5% deviation. In addition, the charging and discharging cycle time and the complete charging and discharging cycle time can be configured.
- Smart cell balance: charging and static balance strategies can be flexibly set to effectively extend the service life.

- Communication interface: PC or intelligent front-end can monitor battery data, control operation and set parameters through telemetry, remote signaling, remote adjustment, remote control and other commands. The communication protocol meets the requirements of YD/T 1363.3 and realizes cascade communication
- Historical data recording, saving and reading: when the battery is abnormal, record and save real-time battery status and alarm information. At present, up to 500 historical fault data can be stored.
- Battery management system parameter setting: battery management system parameters, including cell battery over voltage/under voltage, battery total voltage over voltage/under voltage, charge and discharge over current, battery high/low temperature, battery capacity, working mode, charge and discharge limit current, can be set in the battery monitoring system.
- Working mode: charging and discharging current limiting, constant voltage output, direct output and other working modes can be set in the monitoring system
- Multiple protection functions: hardware protection, battery protection, high and low temperature protection, output short circuit protection, etc.

### 3. Specifications

#### 3.1 Appearance and interface

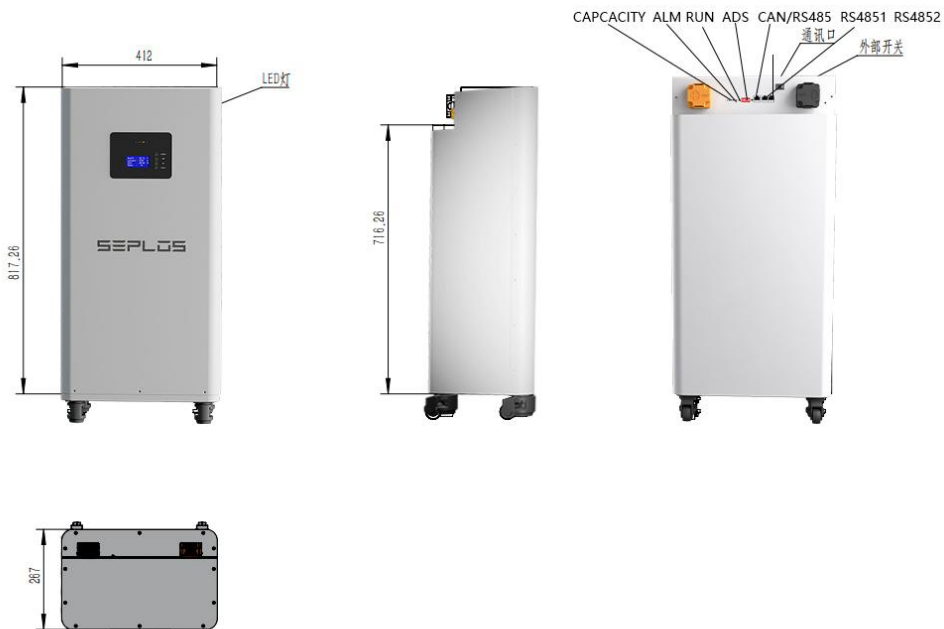

#### 3.2 Electrical schematic diagram

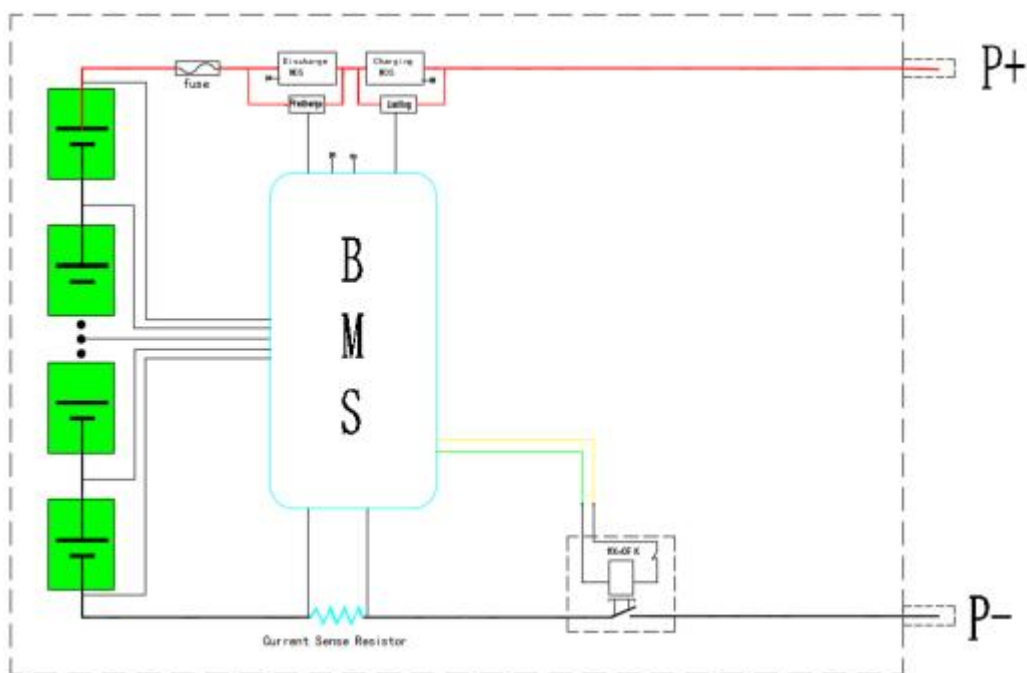

### 3.3 Parameters

Items	Specifications
Rated energy(kWh)	14.336KWh
Configuration	1P16S
Nominal Voltage(V)	51.2V
Working Voltage(V)	42V~58.4V
Nominal Capacity(Ah)	280Ah
Rated charge/discharge Current(A)	100A/200A @25±2℃
Maximum charging current	200A@25±2℃
Maximum discharge current	200A @25±2℃
Working Temperature	0~40℃ (Charge) -20~40℃ (Discharge)
Humidity(%)	5~95%
Altitude Limited(m)	0-3000m
Weight(Kg)	113Kg±3kg
Dimension(mm)	817×412×267mm
Storage temperature and humidity	-10℃~35℃ (Within one month of storage) 25±2℃ (Within three months of storage) 65%±20%RH
cycle life	6000 cycles @25℃ 50A Charge and discharge current 80%DOD
IP grade	IP20
Communication mode	CAN&RS485

### 3.3 Protection parameters

#### 3.3.1 Individual cell over voltage parameters

Individual cell over voltage parameter				
Functions	Status	Item	Default	Configurable Range
Over voltage warning	ON	Over voltage warning	3500mV	Over voltage warning recovery - over voltage protection
		Over voltage warning recovery	3400mV	3000mV - over voltage warning
		Under voltage warning	2900mV	Under voltage protection - under voltage warning recovery
		Under voltage warning recovery	3000mV	Under voltage warning - 3300mV
over voltage protection	ON	Over voltage protection	3650mV	Over voltage warning - 4500mV
		Over voltage protection recovery	3400mV	Over voltage warning recovery - over voltage protection
		Over voltage recovery condition	1. Individual cell voltage decrease to over voltage recovery threshold. 2. The remaining capacity lower than 96% of the intermittent power supply. <b>Both conditions should be satisfied.</b>	
			Output current $\geq 1A$	

#### 3.3.2 Individual cell low voltage parameters

Individual cell low voltage parameter				
Functions	Status	Item	Default	Configurable Range
under voltage protection	ON	Under voltage protection	2700mV	1500mV - under voltage protection recovery
		Under voltage protection recovery	2900mV	Under voltage protection - under voltage warning
		Under voltage protection condition	When an individual cell gets under voltage protection threshold, BMS maintain communication with inverter for 1 minutes and powered off.	
		Under voltage protection recovery	Input current $\geq 1A$	

### 3.3.3 Pack over voltage parameters

Pack over voltage parameter				
Functions	Status	Item	Default	Configurable Range
Over voltage warning	ON	Over voltage warning	56.0V	Over voltage warning recovery - over voltage protection
		Over voltage warning recovery	54.0V	53.0V - over voltage warning
		Under voltage warning	46.4V	Under voltage protection - under voltage warning recovery
		Under voltage warning recovery	48.0V	Under voltage warning - 55.0V
Over voltage protection	ON	Over voltage protection	57.6V	Over voltage warning - 60.0V
		Over voltage protection recovery	54.0V	Over voltage warning recovery - over voltage protection
		Over voltage protection recovery conditions	1. Individual cell voltage decrease to over voltage recovery threshold. 2. The remaining capacity is lower than 96% of the intermittent power supply. Both conditions should be satisfied.	
			Output current $\geq 1A$	

### 3.3.4 Pack low voltage parameters

Pack low voltage parameter				
Functions	Status	Item	Default	Configurable Range
Under voltage protection	ON	Under voltage protection	41.6V	36.0V - under voltage warning recovery
		Under voltage protection recovery	46.0V	Under voltage protection - under voltage warning
		Under voltage protection condition	When the total voltage gets under voltage protection threshold, BMS maintain communication with inverter for 1 minutes and powered off.	
		Under voltage protection recovery conditions	Input current $\geq 1A$	



### 3.3.5 Cell high/low temperature(charging) parameters

Cell high/low temperature (charging) parameters				
Functions	Status	Item	Default	Configurable Range
Cell temperature (Charging)	ON	High temperature warning	50°C	High temperature warning recovery - high temperature protection
		High temperature warning recovery	47°C	35°C - high temperature warning
		High temperature protection (charging)	55°C	High temperature protection recovery - 80°C
		High temperature protection recovery	50°C	High temperature warning recovery - high temperature protection
		Low temperature warning	2°C	Low temperature protection - low temperature warning recovery
		Low temperature warning recovery (charging)	5°C	Low temperature warning - 10°C
		Low temperature protection	-10°C	-20°C - low temperature protection recovery
		Low temperature protection recovery	0°C	Low temperature protection - low temperature warning recovery

### 3.3.6 Cell high/low temperature(charging) parameters

Cell high/low temperature (discharging) parameters				
Functions	Status	Item	Default	Configurable Range
Cell temperature (charging)	ON	High temperature warning	52°C	High temperature warning recovery - high temperature protection
		High temperature warning recovery	47°C	High temperature protection recovery - 80°C
		High temperature protection	55°C	High temperature warning recovery - high temperature protection
		High temperature protection recovery	50°C	High temperature warning recovery - high temperature protection
		Low temperature warning	-10°C	Low temperature protection - low temperature warning recovery
		Low temperature warning recovery	3°C	Low temperature warning - 10°C
		Low temperature protection	-15°C	-30°C - low temperature protection recovery
		Low temperature recovery	0°C	Low temperature protection - low temperature warning recovery

### 3.3.7 Ambient high/low temperature parameters

Ambient high/low temperature parameters				
Functions	Status	Item	Default	Configurable Range
Cell temperature (Discharging)	ON	High temperature warning	50°C	High temperature warning recovery - high temperature protection
		High temperature warning recovery	47°C	-20°C - high temperature warning recovery
		High temperature protection	60°C	High temperature protection recovery -80°C
		High temperature protection recovery	55°C	High temperature warning recovery - high temperature protection
		Low temperature warning	0°C	Low temperature protection - low temperature warning recovery
		Low temperature warning recovery	3°C	Low temperature warning - 60°C
		Low temperature protection	-10°C	-30°C - low temperature protection recovery
		Low temperature protection recovery	0°C	Low temperature protection - low temperature warning recovery

### 3.3.8 MOSFET high/low temperature parameters

MOSFET high/low temperature parameters				
Functions	Status	Item	Default	Configurable Range
MOSFET temperature	ON	High temperature warning	90°C	High temperature warning recovery - high temperature protection
		High temperature warning recovery	85°C	60°C - high temperature warning
		High temperature protection	100°C	High temperature warning - 120°C
		High temperature protection recovery	85°C	High temperature warning recovery - high temperature protection

### 3.3.9 Charging current limiting parameters

Charging current limiting parameters				
Functions	Status	Item	Default	Configurable Range
Current limiting (charging)	OFF	Active current limiting	10A	When the charger current > 10A, current limiting activated.
	ON	Passive current limiting		When the charger current > charging over current warning (configurable), current limiting activated.
		Charging current limiting time delay	5 min	After the current limiting being activated, BMS re-check the current to judge whether to maintain current limiting.

### 3.3.10 Charging over limiting parameters

Charging current limiting parameters				
Functions	Status	Item	Default	Configurable Range
Over current warning (charging)	ON	Over current warning	200A	Charging over current warning recovery - charging over current protection
		Over current warning recovery	195A	0A - charging over current warning
Over current protection (charging)	ON	Over current protection	210A	0A~150A
		Over current protection time delay	10S	Configurable
		Over current protection recovery conditions	BMS detects any output discharge current. After 60 seconds, the protection recovers automatically.	
Effective charging current	Charging current (in)		1000mA	
	Charging current (out)		700mA	

### 3.3.11 Discharging over limiting parameters

Discharging over current parameters				
Functions	Status	Item	Default	Configurable Range
Over current warning	ON	Over current warning	-205A	Over current protection - over current warning recovery
		Over current warning recovery	-203A	Over current warning -0A
Over current protection	ON	Over current protection	-210A	Transient over current protection - 0A
		Over current protection time delay	10S	Configurable
		Over current protection recovery conditions	BMS detects any input charge current. After 60 seconds, the protection recovers automatically.	

### 3.3.12 Transient over limiting parameters

Transient over current parameters				
Functions	Status	Item	Default	Configurable Range
Over current protection (Transient)	ON	Over current protection	-300A	Discharge over current protection - 300A
		Over current protection time delay	30mS	Configurable
		Over current protection recovery	BMS detects any input charge current. After 60 seconds, the protection recovers automatically.	
	OFF	Over current lock	Continuously over current for 2 times. The over current lock times exceeded.	
		Over current lock times	5 times	
		Over current lock release	Connected with charger	

### 3.3.13 Short circuit parameters

Short circuit parameters				
Functions	Status	Item	Default	Configurable Range
Short circuit protection	ON	Short circuit protection current value and time delay	Programmed into the software (can not be edited) Cannot be turned off	
		Short circuit protection recovery	BMS detects any input charge current. After 60 seconds, the protection recovers automatically.	
	ON	Short circuit protection lock	Continuously short in the output circuit. The over current protection lock times exceeded.	
		Short circuit protection lock times	5 times	
		Short circuit protection lock release	Connected with charger	
	Effective discharging current	Discharge current (in)		-1000mA
Discharge current (out)		-700mA		

### 3.3.14 Cell balance parameters

Short circuit parameters					
Functions	Status	Item	Default	Configurable Range	
Cell balance	ON	Standby balance	When there is no charging and discharging current flow, the standby equalization will be activated.		
		Standby time	10 hours	configurable	
	ON	Charging equalization	When at the charging or float charging status, the charging equalization will be activated.		
	Balance conditions	Activate voltage	3350mV	Configurable	
		Activate voltage difference	30mV		
		End voltage	20mV		
	ON	Temperature	According to the temperature range of no equalization (ambient temperature)		
		No equalization high temperature	50°C	Configurable	
		No equalization low temperature	0°C		
Cell failure	ON	Voltage difference	500mV	Configurable	
		Voltage difference recovery	300mV		

### 3.3.15 Cell balance parameters

Capacity parameters				
Capacity	Nominal capacity		200AH	5-200Ah
	Remaining capacity	Calculated accordingly to the cell voltage		Configurable
	Cycle life accumulated capacity	20%	Cycle life (configurable)	
	ON	Remaining capacity warning	15%	
	ON	Remaining capacity protection	8%	Output current flow will be cut off.
Reset button	Power on/activation		When the BMS is in the sleep state, press the 1S reset button, the BMS will be activated, and the LED indicators will turn on in turn, then the BMS will turn into the normal working state	
	Shut down/hibernate		When the BMS is in standby or working state (except charging), press the 3S reset button, the BMS will be hibernated, and the LED indicator lights will turn on in turn, and then the BMS will	

		go into hibernation state;
--	--	----------------------------

### 3.3.16 Other parameters

Pre-charging	2000ms	0-5000ms	The pre-charging function will be activated once the BMS powered on.	
BMS power consumption	ON	Longest standby time	48 hours (Do not connected with charger, and no effective charging current.)	
Heating	ON	Start heating temperature	0°C	Configurable
		Stop heating temperature	10°C	
		Heating function activation	When connected with charger, and the cell temperature reaches the setting value, the heating function activated. Heating function disabled when at standby and discharge status.	
External switch	OFF	When at the standby status, the BMS can be powered on/off through external switches.		
LCD screen	ON	Monitoring software to check the cell voltage, temperature and current.		
Charging activating	ON	1 minutes	The BMS powered off after under voltage protection. Press the button for recovering from protection status and activate output current.	Configurable
Compensating impedance	Connection fault impedance	10mΩ	Default between 8 and 9	Battery connection line impedance compensation
	Compensation 1	0m Ω	9	Configurable
	Compensation 2	0m Ω	13	

## 4. Communication

### 4.1 CAN communication

BMS transmit information through CAN interface. Buad rate 500KBITS/S. CAN interface applies 8P8C connectors. And CAN connector communicates with inverter or CAN TEST. RS485 collect the information. Then CAN transmit the battery pack information to PCS.

CAN connector definition:

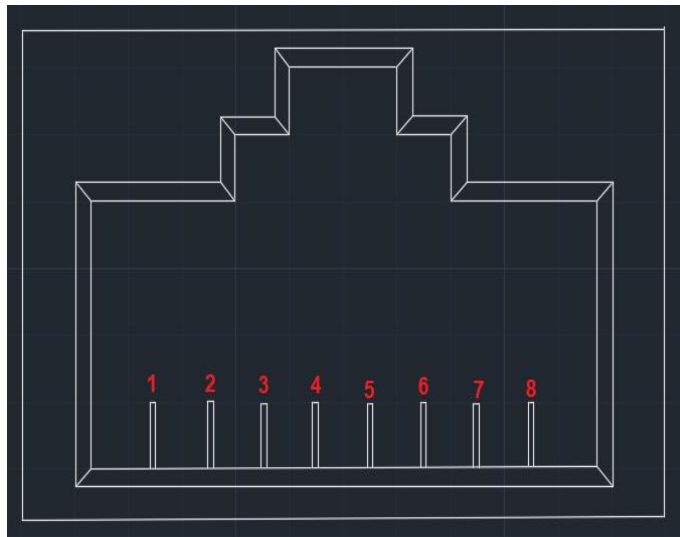

PINS	DEFINITION
1、 2、 7、 8	NC
4	CAN-L
5	CAN-H
3、 6	GND



### 4.2 RS485

BMS could collect battery pack information through RS485 communication.

Baud rate: 19200bps. RS485 interface applies 8p8c connectors.

RS485 connectors definition:

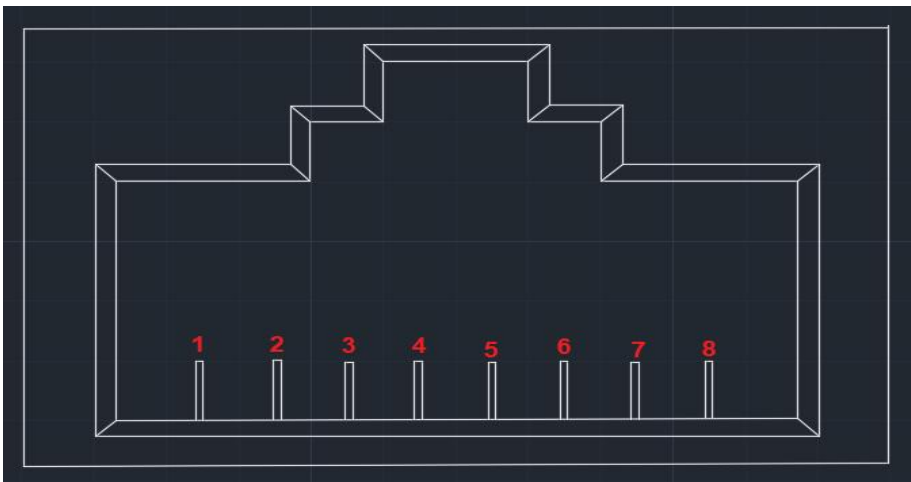

PINS	DEFINITION
1/8	RS485-B
2/7	RS485-A
3/6	GROUND
4/5	Internal communication (NC)

### 4.3 Parallel

When connected in parallel with RS485 connectors. CAN connectors act as upper communication interface. End devices could get the collected battery information through CAN interface.

RS485 connector connection:

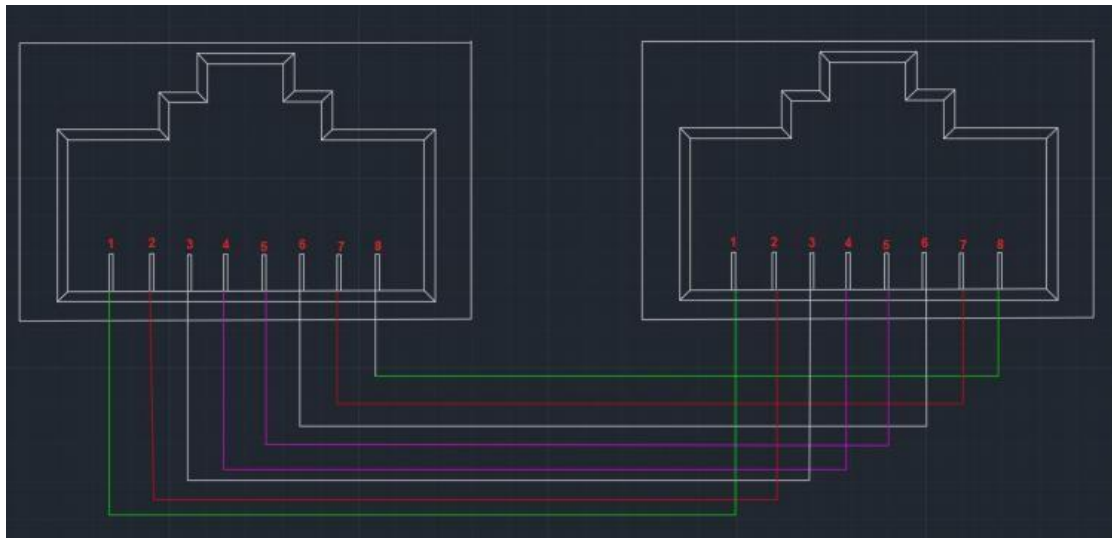

### 4.4 DIP switch

**DIP ADDRESS:** If the battery packs is connected in parallel, the DIP address identifies each pack with different addresses.

Bit 1 to 4 for different address of paralleled packs. Bit 5 to 8 for the quantity of slave packs.

**Host settings:** bit1 to bit4 are 0, the host address is fixed to 0, and bit5 to bit8 are set according to the number of parallel slaves. (See Table 2)

**Slave setting:** bit1 to bit4 are set according to the device sequence, and the slave address range is 1 to 15. Bit5 to bit8 are fixed to 0. (See Table 1)

Check Appendix for details.

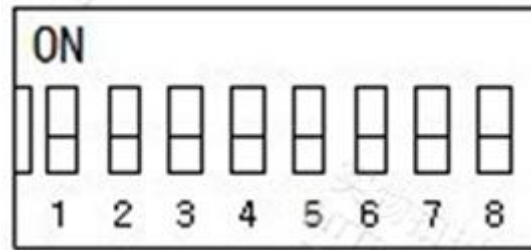

## 5. Working mode

### 5.1 Charging mode

When a charger was detected, and the charger voltage is 0.5V+ more than the battery voltage, BMS will turn on the charging MOSFET. And when the charging current reaches the effective charging current value, enters charging mode.

### 5.2 Discharging mode

When a loads was detected, and the discharging current reaches the effective charging current value, BMS enters discharging mode.

### 5.3 Standby mode

When the BMS not in charging mode, nor discharging mode, it enters standby mode.

### 5.4 Power off mode

#### 5.4.1 Power off

When meet any condition as below, the system will be power off (without charger only)

- 1) Individual or entirety battery remain over discharge protecting mode within 30 seconds.
- 2) Press the button in 3 seconds. (make sure no charger connected, otherwise it will not enter low power mode.)

#### 5.4.2 Awaken

When meet any condition as below, the system will be enter working

mode

- 1) Connect the charger and the voltage need reach more than 300V.
- 2) Press the power button in 3 seconds to start the system







## 6. LED indicator

### 6.1 LED lights









One running indicator (Green)

One warning indicator (Red)

And four capacity indicator (Green)

					
SOC				ALARM	RUN

### 6.2 Capacity indicators

Status	Charging				Discharging			
Capacity	L4 	L3 	L2 	L1 	L4 	L3 	L2 	L1 
0-25%	OFF	OFF	OFF	Blink	OFF	OFF	OFF	Green
25%-50%	OFF	OFF	Blink	Green	OFF	OFF	Green	Green
50%-75%	OFF	Blink	Green	Green	OFF	Green	Green	Green
≥75%	Blink	Green	Green	Green	Green	Green	Green	Green
Running	Green				Blink			

### 6.3 Lights blinking explanation A

Blink Type	Lighten TIEM	OFF TIME
Blink A	0.25S	3.75S
Blink B	0.5S	0.5S
Blink C	0.5S	1.5S

### 6.4 Running status indicators

SYSTEM	Running	RUN	ALM	SOC				REMARK
		●	●	●	●	●	●	
OFF	Sleeping	OFF	OFF	OFF	OFF	OFF	OFF	OFF
STANDBY	Running	Blink A	OFF	OFF	OFF	OFF	OFF	Standby
CHARGE	Running	Green	OFF	According to the remaining capacity				LED Blink B
	Over current warning	Green	Blink B	According to the remaining capacity				LED Blink B
	Over voltage protection	Blink A	OFF	OFF	OFF	OFF	OFF	
	Temp And over current protection	Blink A	Blink A	OFF	OFF	OFF	OFF	
DISCHARGE	Running	Blink C	OFF	According to the remaining capacity				
	warning	Blink C	Blink C	capacity				
	Temp Over current, short circuit protection	OFF	RED	OFF	OFF	OFF	OFF	
	Under voltage protection	OFF	OFF	OFF	OFF	OFF	OFF	No discharge

### 6.5 Installation and commissioning

NO.	Item	Quantity	Photo
1	Battery Box	1 PCS	

### 6.6 Installation instructions

Check battery status before installation



## 7. Safety precautions

- Do not place the battery on flammable building materials.
- Recommended to hang the battery on the vertical wall.
- The temperature should be between 10 °C and 30 °C to maintain the best operating state.
- The installation site should be some free space around the battery to dissipate heat (as shown in the figure below), which is suitable for installation on the concrete surface or other non-flammable surfaces.





## 7.1 Harness connection

The battery should be turned off before connecting.

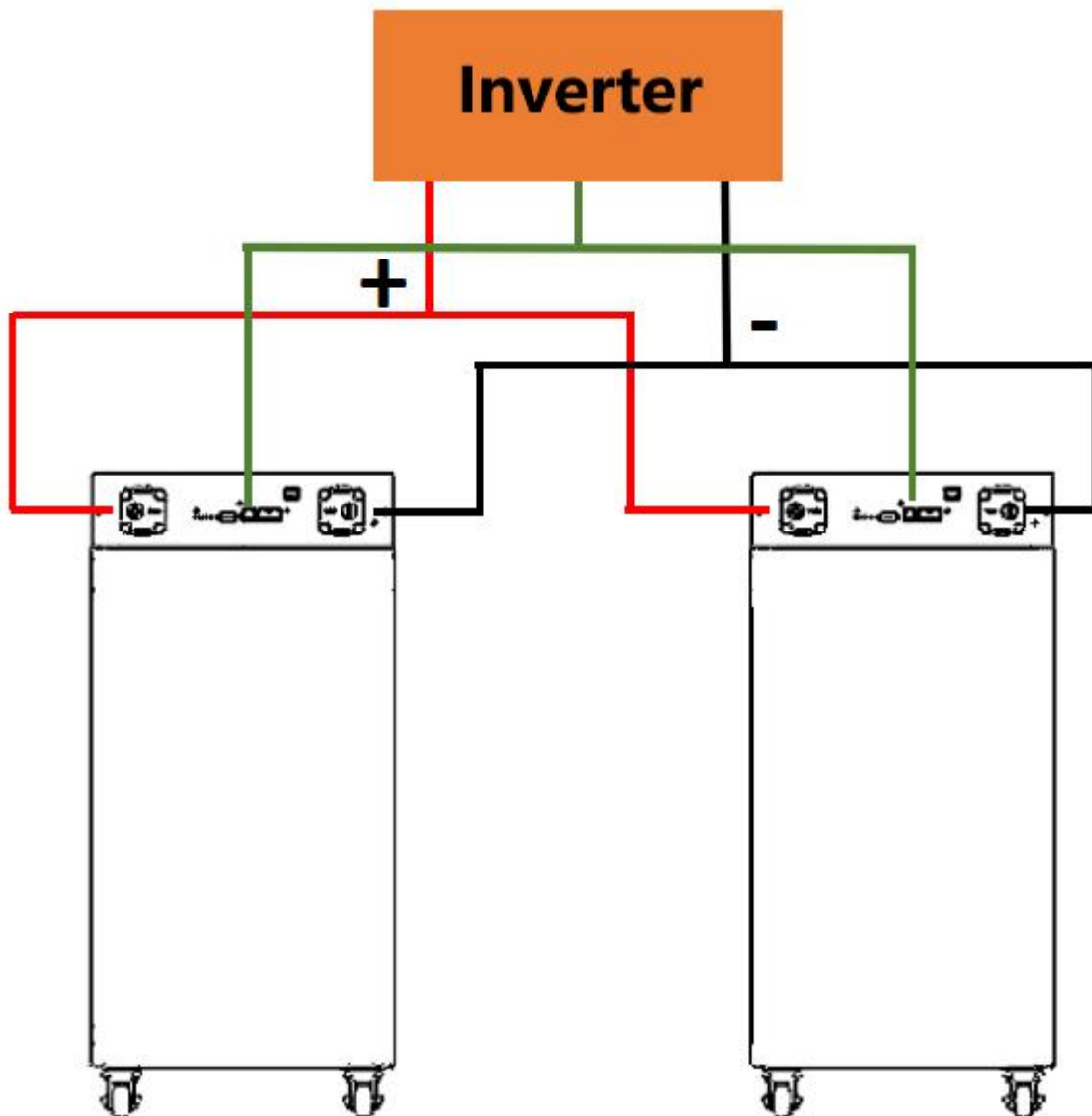

## 7.2 DIP setting

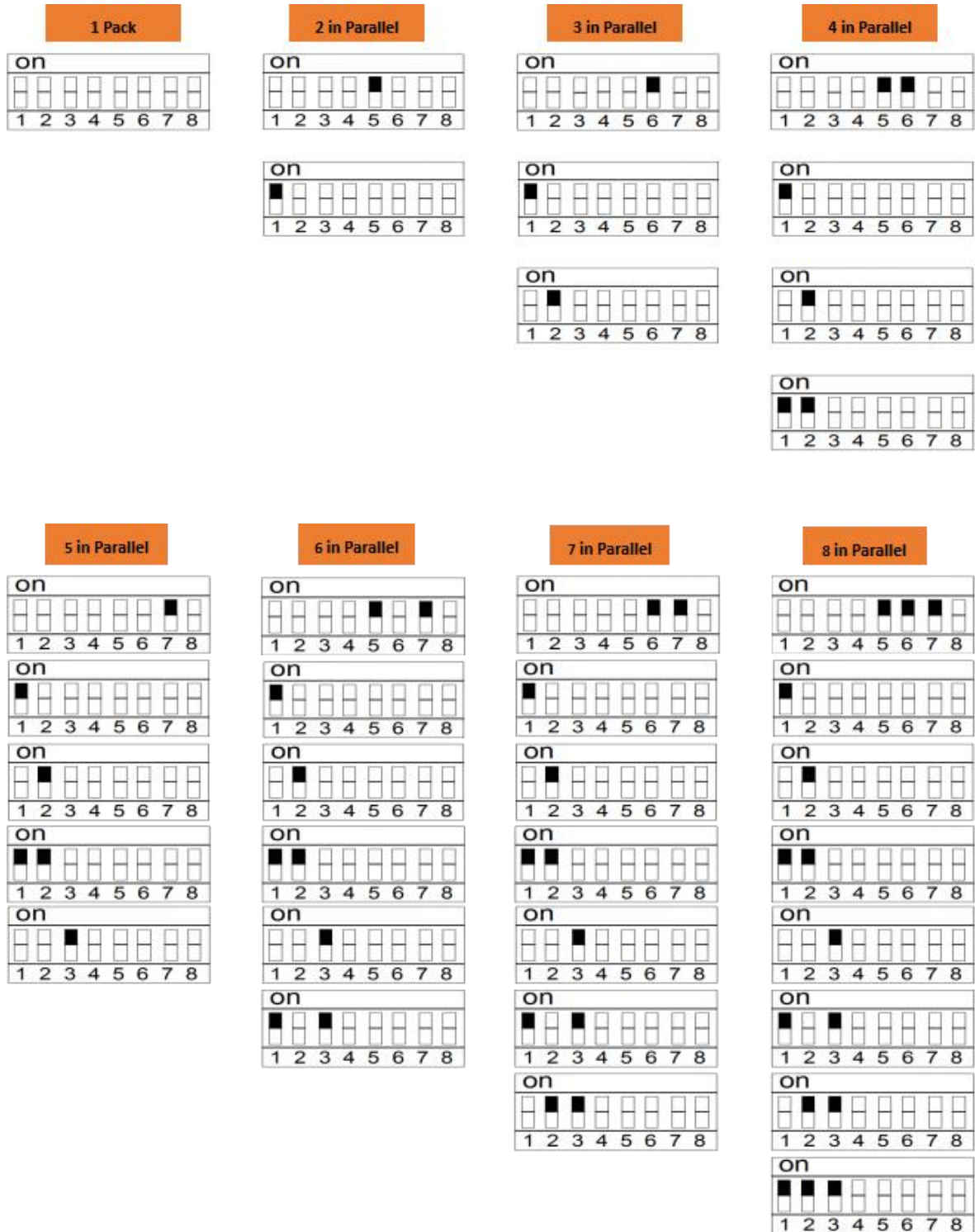

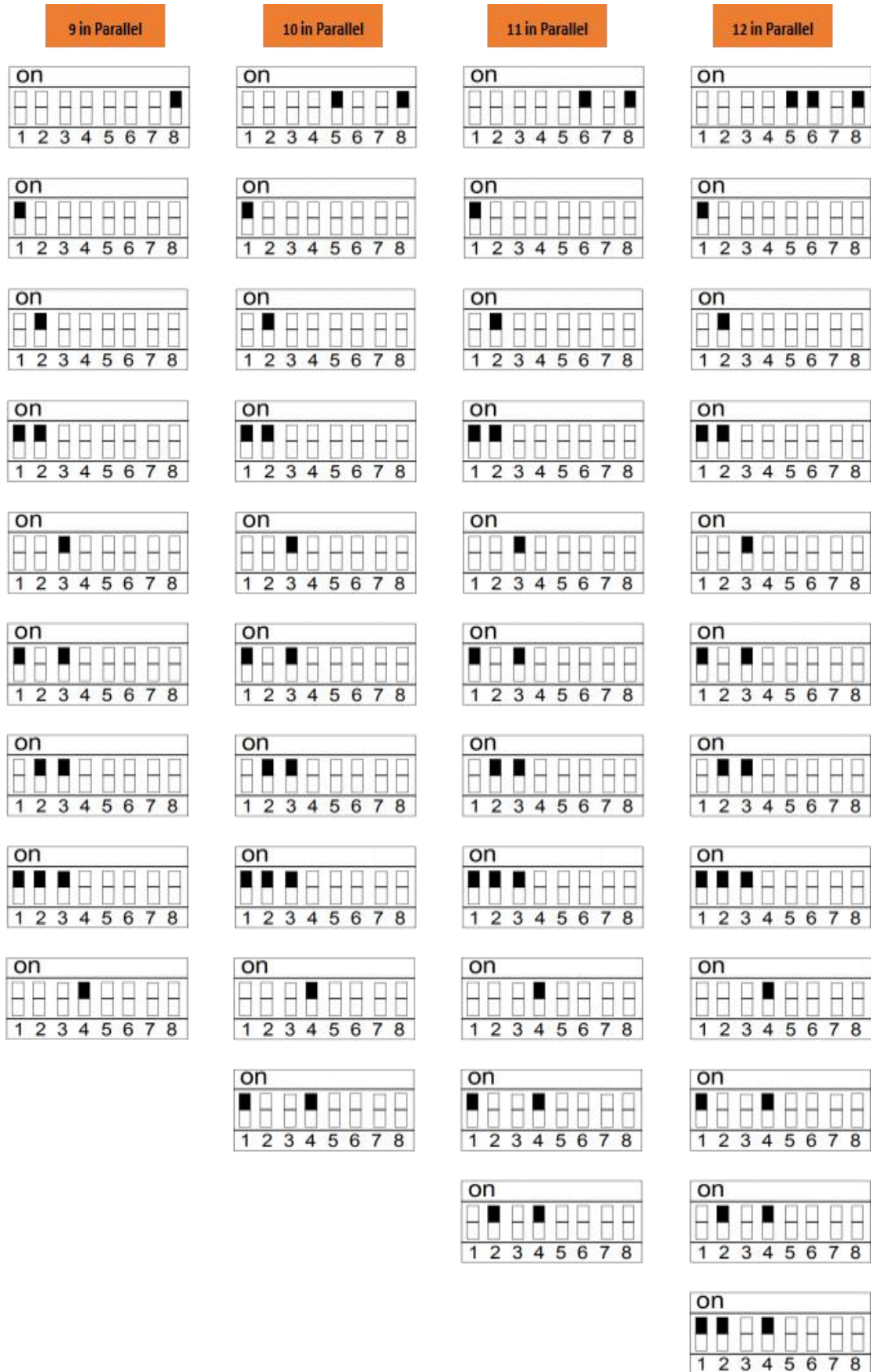

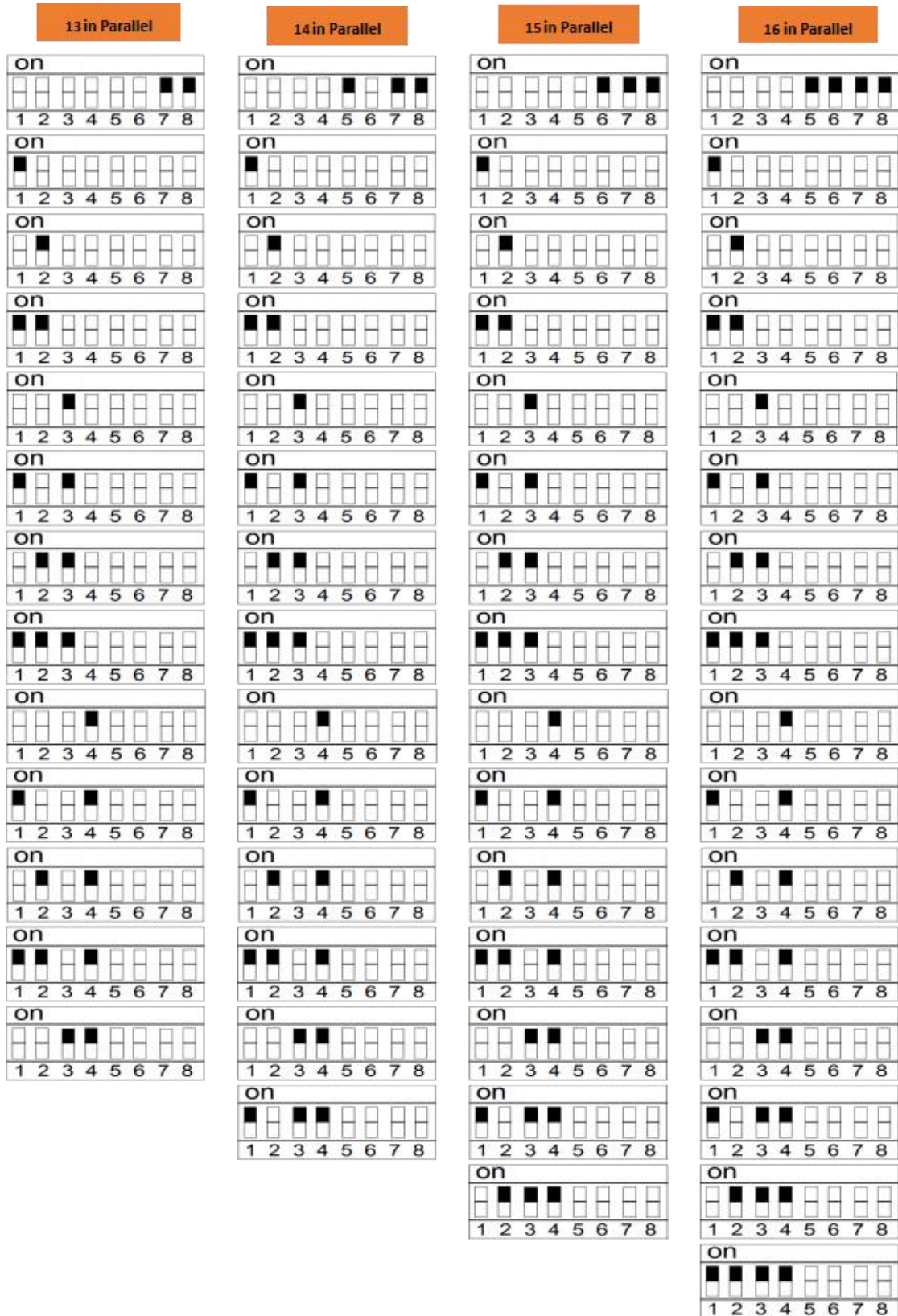

## 8. Package

Packed in a dry, dust proof and moisture-proof packaging box. The products shall be packed with plastic film/EPE and packed in cartons.

Specification: L 97cm\*W50cm\*H 36cm

Package quantity: 1 set

Weight: 113kg

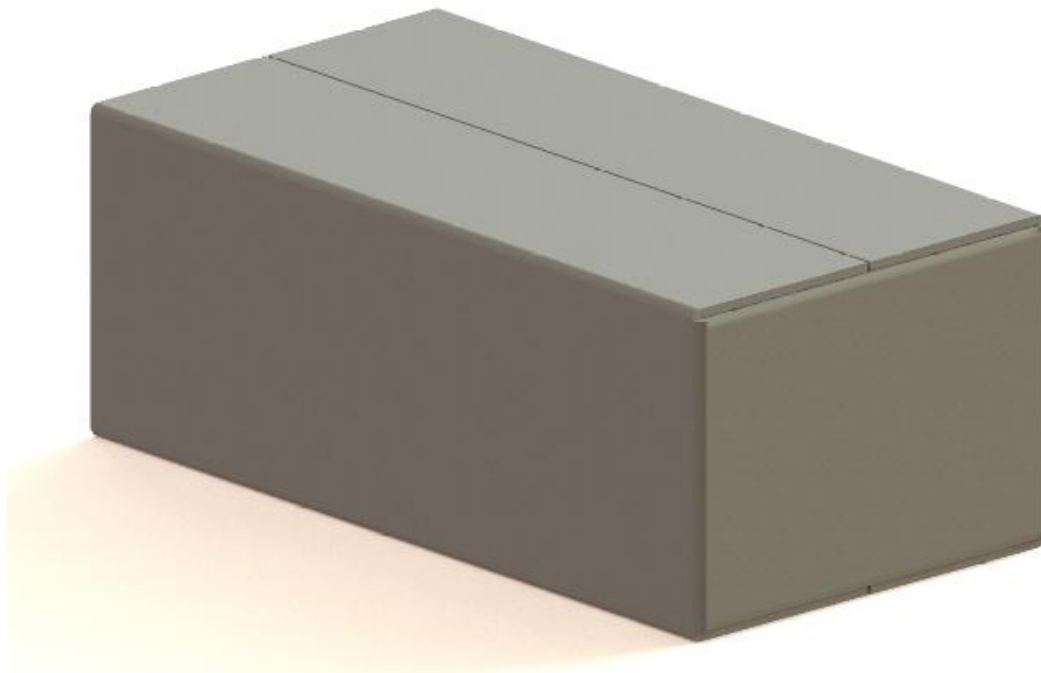

## 9. Safety precaution

- Do not use the pack if there's any deformation.
- Do not stack up the battery.
- Please be notice the polarity of the battery and port.
- Make sure the insulation of equipment, use the tool and instrument correctly.
- The installation site should stay away from fire and Inflammable,keep ventilating and dry.
- Do not disconnect the battery terminals when its running.
- Not allow non-technology staff to open all of function module.
- Please fully charge a new battery pack, or a long-time-no-use battery pack with a designed charger.
- Do not uninstall,open, extrude, bend, impale or break the battery.
- Do not refit the battery or connect to other object, do not immerse the battery into any water, sea water, or drinks and other liquids.stay away from fire, explosive material or other dangerous item.
- Do not allow the battery short circuit, do not any metal or conductor contact the terminal.
- Do not let the battery fall. if does, especially on the solid surface, please contact the service center.
- If there is any signs of Electrolyte leakage, do not let it get any direct contact with your bare skin or eyes. If it happened, use plenty of water to clean up or ask doctor for help.
- Do not uninstall the battery cell, or there will cause internal short even fire disaster or other issue.
- Do not burn the battery or throw it to the fire, otherwise, there will be cause the fire of the battery.