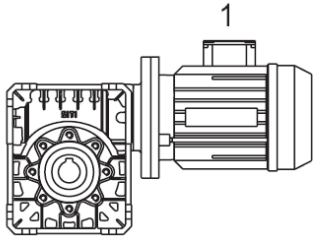
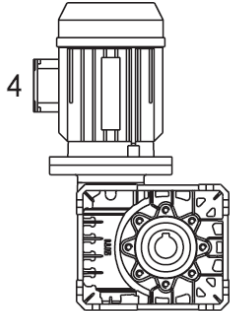
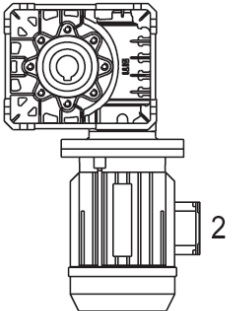
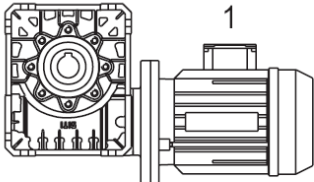
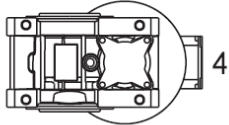
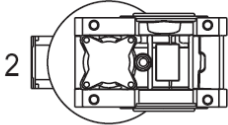
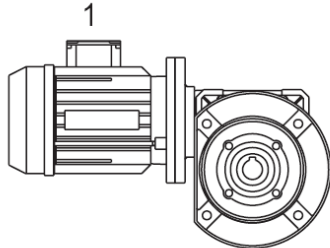
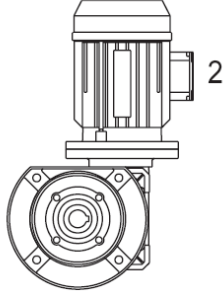
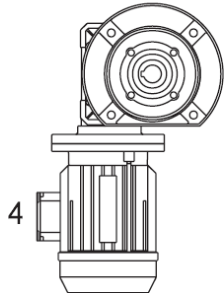
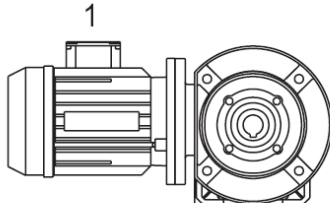
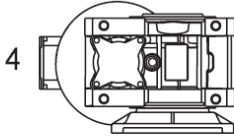
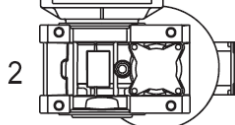

POSIZIONI DI MONTAGGIO / MOUNTING POSITION / EINBAULAGEN

U-MU	B3		V5		V6	
	B8		B6		B7	
F-FBR-FBM-FBML	B3		V5		V6	
	B8		B6		B7	

Per le posizioni di piazzamento non contemplate occorre rivolgersi al nostro servizio tecnico.

For not specified mounting positions contact our technical advise service.

Ist eine gewünschte Bauform nicht aufgeführt, bitten wir um Rücksprache.

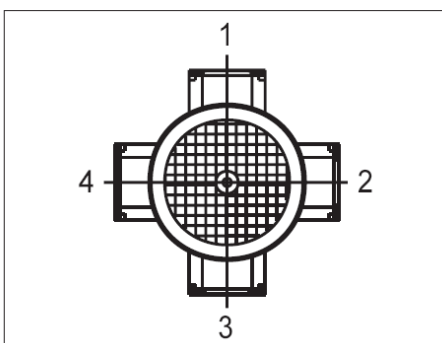

POSIZIONE MORSETTIERA / POSITION OF TERMINAL BOX / KLEMMENKASTEN

Nel caso di particolari esigenze specificare in fase di ordine la posizione della Morsettiera come da schema.

For special requirements, orders must specify the position of the terminal box with reference to the diagram. Unless otherwise specified the terminal box will be mounted as shown in the diagram for the mounting position.

Sofern in der Bestellbezeichnung nicht angegeben, wird das Klemmenbrett gemäß Übersicht angeordnet.