

VEVOR[®]

TOUGH TOOLS, HALF PRICE

Technical Support and E-Warranty Certificate

www.vevor.com/support

STAINLESS STEEL HANDRAIL

MODEL: BX-80 \ BX-100 \ BX-120

We continue to be committed to provide you tools with competitive price. "Save Half", "Half Price" or any other similar expressions used by us only represents an estimate of savings you might benefit from buying certain tools with us compared to the major top brands and does not necessarily mean to cover all categories of tools offered by us. You are kindly reminded to verify carefully when you are placing an order with us if you are actually saving half in comparison with the top major brands.

VEVOR[®]
TOUGH TOOLS, HALF PRICE

**STAINLESS STEEL
HANDRAIL**

MODEL: BX-80 \ BX-100 \ BX-120

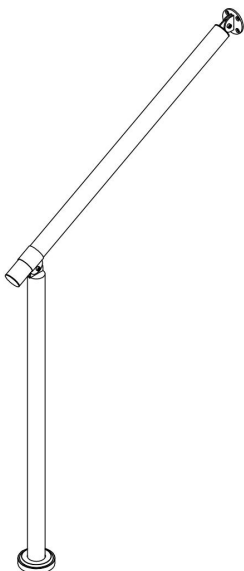

NEED HELP? CONTACT US!

Have product questions? Need technical support?
Please feel free to contact us:

Technical Support and E-Warranty Certificate
www.vevor.com/support

This is the original instruction, please read all manual instructions carefully before operating. VEVOR reserves a clear interpretation of our user manual. The appearance of the product shall be subject to the product you received. Please forgive us that we won't inform you again if there are any technology or software updates on our product.

SAFE INSTRUCTIONS

CAUTION: Carefully read instructions and procedures for safe operations. Failure to do so can result in serious injury.



WARNING:

1. Before using the handrail, ensure that the handrail is securely installed to prevent personal injury and accidents.
2. When using the handrail, do not overload the handrail to avoid personal injury or accident.
3. Do not draw, cut, or use sharp objects on the handrail to avoid damage.
4. If you need to disassemble the handrail, please follow the reverse steps to disassemble and store it properly.
5. This product is not a toy. Do not allow children to play with this item.









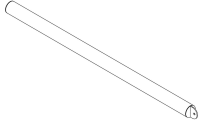

ASSEMBLY PRECAUTIONS

1. Assemble only according to these instructions. Improper assembly can create hazards.
2. Wear ANSI-approved safety goggles and heavy-duty work gloves during assembly.
3. Keep assembly area clean and well-lit.
4. Keep bystanders out of the area during assembly.
5. Do not assemble when tired or under the influence of alcohol, drugs or medication.
6. Product capabilities apply to properly and completely assembled products only.
7. For additional information regarding the parts listed in the following pages, please refer to the Assembly Diagram of this manual. Unwrap and separate all parts in a clean work area.
8. For safety reasons, this hardware is recommended to be installed by 2 people .

SAVE THESE INSTRUCTIONS

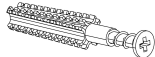
Model	Length Of Handrail (mm)
BX-80	800
BX-100	1000
BX-120	1200

COMPONENTS

No.	Name	Picture	QTY.
A	Pillar		1
B	Decorative Cover		1
C	Adjustable Support		1
D	Handrail		1
E	Fixed Part		1
F	Screw M6*16		2
G	Nut M6		2
H	Expansion Bolt		8
I	Wrench		1
J	Hex Key		2
K	Drill Bit		1

L	Scouring Pad		1
---	--------------	---	---

STEP 1:

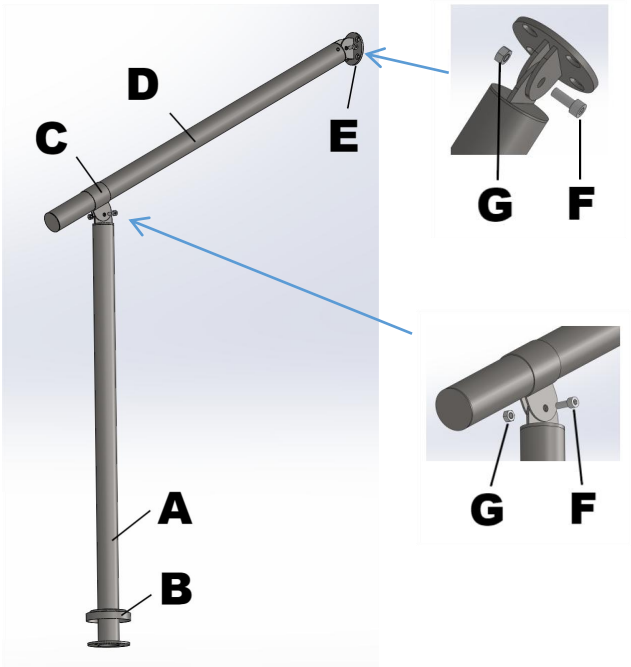

STEP 2:

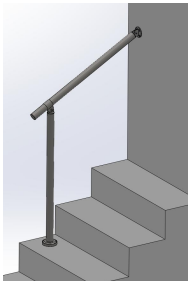

STEP 3:

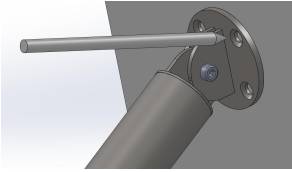

STEP 4:

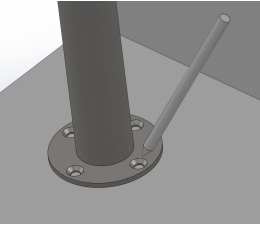

STEP 5:

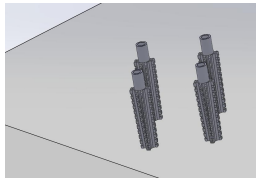
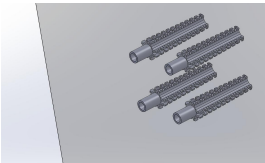

STEP 6:

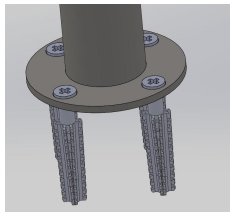
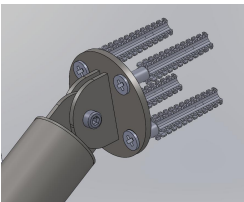

STEP 7:

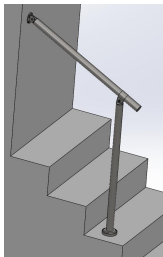

Manufacturer: Shanghaimuxinmuyeyouxiangongsi

Address: Shuangchenglu

803nong11hao1602A-1609shi, baoshanqu, shanghai
200000 CN.

Imported to AUS: SIHAO PTY LTD. 1 ROKEVA
STREETEASTWOOD NSW 2122 Australia

Imported to USA: Sanven Technology Ltd. Suite 250,
9166 Anaheim Place, Rancho Cucamonga, CA 91730



YH CONSULTING LIMITED.

C/O YH Consulting Limited Office 147,
Centurion House, London Road,
Staines-upon-Thames, Surrey, TW18 4AX



E-CrossStu GmbH

Mainzer Landstr.69,
60329 Frankfurt am Main.

VEVOR[®]

TOUGH TOOLS, HALF PRICE

Technical Support and E-Warranty Certificate

www.vevor.com/support

VEVOR[®]

TOUGH TOOLS, HALF PRICE

Assistance technique et certificat de garantie

électronique www.vevor.com/support

MAIN COURANTE EN ACIER INOXYDABLE

MODÈLE : BX-80 \ BX-100 \ BX-120

Nous continuons à nous engager à vous fournir des outils à des prix compétitifs. "Économisez la moitié", "Moitié prix" ou toute autre expression similaire que nous utilisons ne représente qu'une estimation des économies dont vous pourriez bénéficier en achetant certains outils chez nous par rapport aux grandes marques et ne signifie pas nécessairement couvrir toutes les catégories d'outils proposés. par nous. Nous vous rappelons de bien vouloir vérifier attentivement lorsque vous passez une commande chez nous si vous économisez réellement la moitié par rapport aux grandes mar

VEVOR[®]
TOUGH TOOLS, HALF PRICE

ACIER INOXYDABLE
BALUSTRADE

MODÈLE : BX-80 \ BX-100 \ BX-120

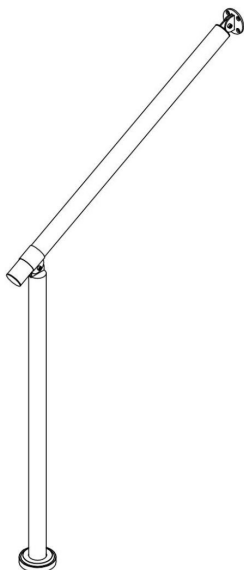

BESOIN D'AIDE? CONTACTEZ-NOUS!

Vous avez des questions sur les produits ? Besoin d'une assistance technique ?
N'hésitez pas à nous contacter:

Assistance technique et certificat de garantie électronique
www.vevor.com/support

Il s'agit des instructions originales, veuillez lire attentivement toutes les instructions du manuel avant de l'utiliser. VEVOR se réserve une interprétation claire de notre manuel d'utilisation. L'apparence du produit dépend du produit que vous avez reçu.

Veuillez nous pardonner que nous ne vous informerons plus s'il y a des mises à jour technologiques ou logicielles sur notre produit.

CONSIGNES DE SÉCURITÉ

ATTENTION : Lisez attentivement les instructions et les procédures pour des opérations en toute sécurité. Ne pas le faire peut entraîner de graves



blessure. AVERTISSEMENT :

1. Avant d'utiliser la main courante, assurez-vous qu'elle est solidement installé pour éviter les blessures corporelles et les accidents.
2. Lorsque vous utilisez la main courante, ne surchargez pas la main courante pour éviter des blessures ou des accidents.
3. Ne dessinez pas, ne coupez pas et n'utilisez pas d'objets pointus sur la main courante pour éviter les dommages.
4. Si vous devez démonter la main courante, veuillez suivre suivez les étapes inverses pour le démonter et le ranger correctement.
5. Ce produit n'est pas un jouet. Ne laissez pas les enfants jouer avec cet article.









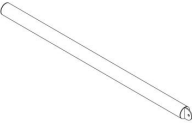

PRÉCAUTIONS DE MONTAGE

1. Assemblez uniquement selon ces instructions.
Un assemblage incorrect peut créer des dangers.
2. Portez des lunettes de sécurité approuvées par l'ANSI et des lunettes robustes. gants de travail lors du montage.
3. Gardez la zone de rassemblement propre et bien éclairée.
4. Gardez les spectateurs hors de la zone pendant l'assemblage.
5. Ne pas assembler lorsque vous êtes fatigué ou sous l'influence de alcool, drogues ou médicaments.
6. Les capacités du produit s'appliquent correctement et complètement produits assemblés uniquement.
7. Pour plus d'informations concernant les pièces répertoriées dans les pages suivantes, veuillez vous référer à l'Assemblée Schéma de ce manuel. Déballez et séparez toutes les pièces dans une zone de travail propre.
8. Pour des raisons de sécurité, il est recommandé d'utiliser ce matériel être installé par 2 personnes.

CONSERVEZ CES INSTRUCTIONS

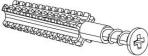
Modèle	Longueur de la main courante (mm)
BX-80	800
BX-100	1000
BX-120	1200

COMPOSANTS

Non.	Nom	Image	QTÉ.
UN	Pilier		1
B	Décoratif Couverture		1
C	Ajustable Soutien		1
D	Balustrade		1
ET	Partie fixe		1
	Vis F M6*16		2
g	Écrou M6		2
	Boulon d'expansion H		8
.	Clé		1
J.	Clé hexagonale		2
K	Foret		1

L	Tampon à récurer		1
---	------------------	---	---

ÉTAPE 1:

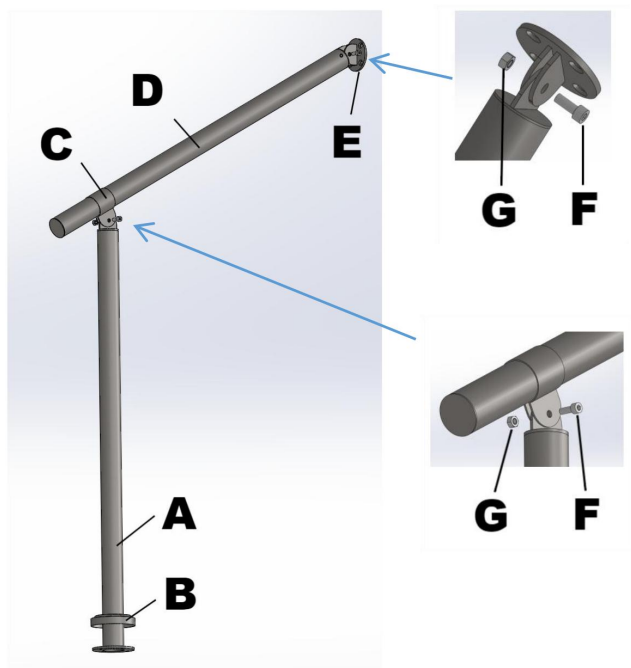

ÉTAPE 2:

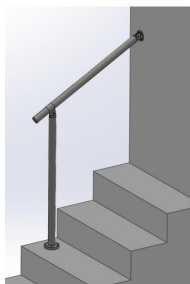

ÉTAPE 3:

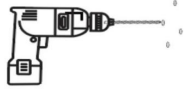
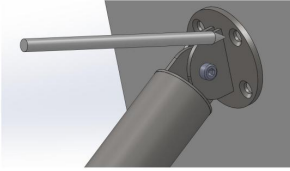

ÉTAPE 4:

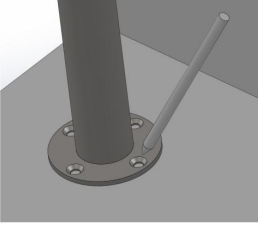

ÉTAPE 5 :

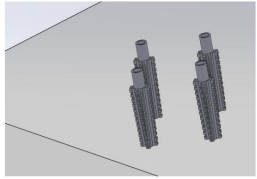
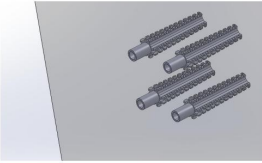

ÉTAPE 6 :

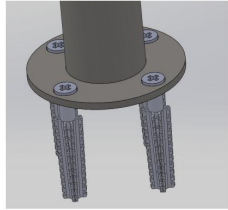
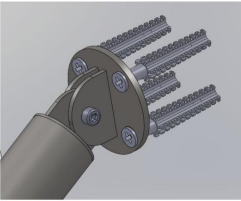

ÉTAPE 7 :

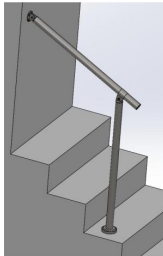

Fabricant : Shanghaimuxinmuyeyouxiangongsi Adresse :

Shuangchenglu

803nong11hao1602A-1609shi, baoshanqu, shanghai 200000 CN.

Importé en Australie : SIHAO PTY LTD. 1 ROKEVA

STREETASTWOOD NSW 2122 Australie

Importé aux États-Unis : Sanven Technology Ltd. Suite 250, 9166

Anaheim Place, Rancho Cucamonga, CA 91730



YH CONSULTING LIMITED.

C/O YH Consulting Limited Office 147,

Centurion House, London Road,

Staines-upon-Thames, Surrey, TW18 4AX



E-CrossStu GmbH

Mainzer Landstr.69,

60329 Frankfurt am Main.

VEVOR[®]

TOUGH TOOLS, HALF PRICE

Assistance technique et certificat de garantie

électronique www.vevor.com/support

VEVOR[®]

TOUGH TOOLS, HALF PRICE

Technischer Support und E-Garantie-Zertifikat

www.vevor.com/support

EDELSTAHL-HANDLAUF

MODELL: BX-80 \ BX-100 \ BX-120

Wir sind weiterhin bestrebt, Ihnen Werkzeuge zu wettbewerbsfähigen Preisen anzubieten. „Sparen Sie die Hälfte“, „Halber Preis“ oder andere ähnliche Ausdrücke, die wir verwenden, stellen nur eine Schätzung der Ersparnis dar, die Sie beim Kauf bestimmter Werkzeuge bei uns im Vergleich zu den großen Topmarken erzielen können, und decken nicht notwendigerweise alle von uns angebotenen Werkzeugkategorien ab. Wir möchten Sie freundlich daran erinnern, bei einer Bestellung bei uns sorgfältig zu prüfen, ob Sie im Vergleich zu den großen Topmarken

VEVOR[®]
TOUGH TOOLS, HALF PRICE

EDELSTAHL
GELÄNDER

MODELL: BX-80 \ BX-100 \ BX-120

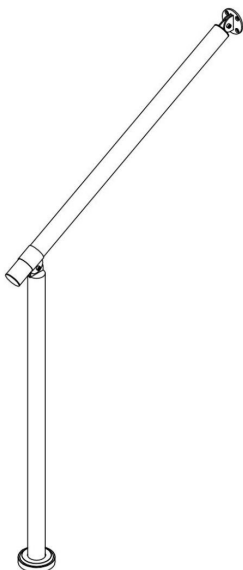

Brauchen Sie Hilfe? Kontaktieren Sie uns!

Sie haben Fragen zu Produkten? Benötigen Sie technischen Support?
Sie können uns gerne kontaktieren:

Technischer Support und E-Garantie-Zertifikat
www.vevor.com/support

Dies ist die Originalanleitung. Bitte lesen Sie alle Anweisungen sorgfältig durch, bevor Sie das Gerät in Betrieb nehmen. VEVOR behält sich eine klare Auslegung unserer Bedienungsanleitung vor. Das Aussehen des Produkts hängt vom Produkt ab, das Sie erhalten haben.
Bitte haben Sie Verständnis, dass wir Sie nicht erneut informieren, wenn es Technik- oder Software-Updates zu unserem Produkt gibt.

SICHERE ANWEISUNGEN

ACHTUNG: Lesen Sie die Anweisungen und Verfahren sorgfältig durch für einen sicheren Betrieb. Andernfalls kann es zu schweren



Verletzungen.WARNUNG:

1. Bevor Sie den Handlauf verwenden, stellen Sie sicher, dass der Handlauf sicher installiert, um Verletzungen zu verhindern und Unfälle.
2. Wenn Sie den Handlauf benutzen, überlasten Sie ihn nicht um Verletzungen oder Unfälle zu vermeiden.
3. Zeichnen, schneiden oder verwenden Sie keine scharfen Gegenstände am Handlauf um Schäden zu vermeiden.
4. Wenn Sie den Handlauf demontieren müssen, folgen Sie bitte
Führen Sie die Schritte in umgekehrter Reihenfolge aus, um es ordnungsgemäß zu zerlegen und zu lagern.
5. Dieses Produkt ist kein Spielzeug. Erlauben Sie Kindern nicht, damit zu spielen. mit diesem Artikel.









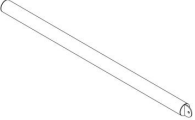

VORSICHTSMASSNAHMEN BEI DER MONTAGE

1. Die Montage muss ausschließlich gemäß dieser Anleitung erfolgen.
Durch unsachgemäße Montage können Gefahren entstehen.
2. Tragen Sie eine ANSI-zugelassene Schutzbrille und Arbeitshandschuhe bei der Montage.
3. Halten Sie den Versammlungsbereich sauber und gut beleuchtet.
4. Halten Sie während der Montage unbeteiligte Zuschauer vom Bereich fern.
5. Montieren Sie nicht, wenn Sie müde sind oder unter dem Einfluss von Alkohol, Drogen oder Medikamente.
6. Produktfunktionen gelten für richtig und vollständig nur montierte Produkte.
7. Weitere Informationen zu den in
Auf den folgenden Seiten finden Sie die Montageanleitung Diagramm dieses Handbuchs. Alle Teile auspacken und trennen in einem sauberen Arbeitsbereich.
8. Aus Sicherheitsgründen wird empfohlen, diese Hardware von 2 Personen zu montieren.

ANLEITUNG AUFBEWAHREN

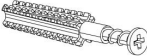
Modell	Länge des Handlaufs (mm)
BX-80	800
BX-100	1000
BX-120	1200

KOMPONENTEN

NEIN.	Name	Bild	MENGE.
A	Säule		1
B	Dekorativ Abdeckung		1
C	Einstellbar Unterstützung		1
D	Geländer		1
UND	Fester Teil		1
F	Schraube M6*16		2
G	Mutter M6		2
H	Spreizdübel		8
.	Schlüssel		1
J	Sechskantschlüssel		2
K	Bohrer		1

M	Scheuerschwamm		1
---	----------------	---	---

SCHRITT 1:

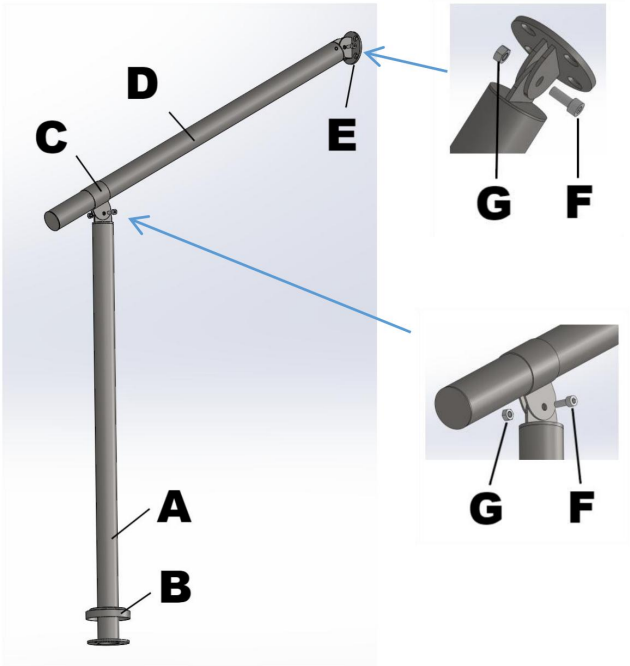

SCHRITT 2:

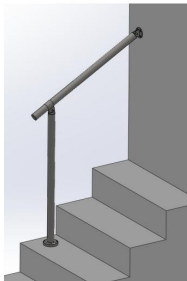

SCHRITT 3:

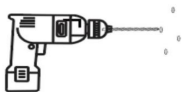
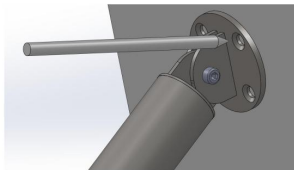

SCHRITT 4:

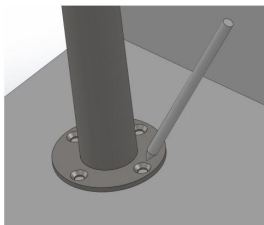

SCHRITT 5:

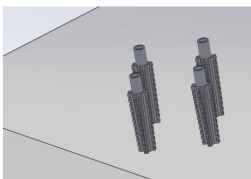
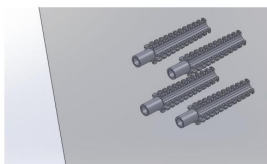

SCHRITT 6:

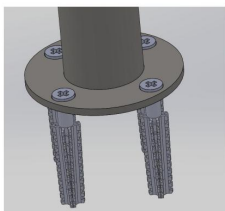
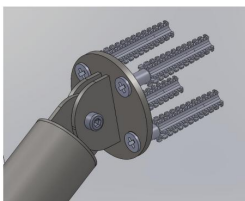

SCHRITT 7:

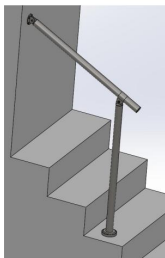

Hersteller: Shanghaimuxinmuyeyouxiangongsi **Adresse:**

Shuangchenglu

803nong11hao1602A-1609shi, baoshanqu, Shanghai 200000 CN.

Nach AUS importiert: SIHAO PTY LTD. 1 ROKEVA

STREETEASTWOOD NSW 2122 Australien

Importiert in die USA: Sanven Technology Ltd. Suite 250, 9166

Anaheim Place, Rancho Cucamonga, CA 91730



YH CONSULTING LIMITED.

C/O YH Consulting Limited Office 147,

Centurion House, London Road,

Staines-upon-Thames, Surrey, TW18 4AX



E-CrossStu GmbH

Mainzer Landstr.69,

60329 Frankfurt am Main.

VEVOR[®]

TOUGH TOOLS, HALF PRICE

Technischer Support und E-Garantie-Zertifikat

www.vevor.com/support

VEVOR[®]

TOUGH TOOLS, HALF PRICE

Supporto tecnico e certificato di garanzia

elettronica www.vevor.com/support

CORRIMANO IN ACCIAIO INOSSIDABILE

MODELLO: BX-80 \ BX-100 \ BX-120

Continuiamo a impegnarci per fornirvi strumenti a prezzi competitivi. "Risparmia la metà", "Metà prezzo" o qualsiasi altra espressione simile da noi utilizzata rappresenta solo una stima del risparmio che potresti trarre dall'acquistare determinati strumenti con noi rispetto ai principali marchi più importanti e non significa necessariamente coprire tutte le categorie di strumenti offerti da noi. Ti ricordiamo di verificare attentamente quando effettui un ordine con noi se stai effettivamente risparmiando la metà rispetto ai migliori marchi pr

VEVOR[®]
TOUGH TOOLS, HALF PRICE

ACCIAIO INOSSIDABILE
CORRIMANO

MODELLO: BX-80 \ BX-100 \ BX-120

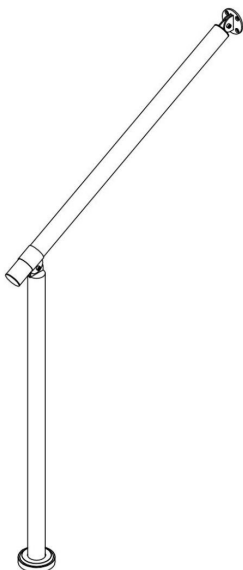

HO BISOGNO DI AIUTO? CONTATTACI!

Hai domande sul prodotto? Hai bisogno di supporto tecnico?
Non esitate a contattarci:

Supporto tecnico e certificato di garanzia elettronica
www.vevor.com/support

Queste sono le istruzioni originali, leggere attentamente tutte le istruzioni del manuale prima dell'uso. VEVOR si riserva una chiara interpretazione del nostro manuale d'uso. L'aspetto del prodotto sarà soggetto al prodotto ricevuto.

Ti preghiamo di perdonarci se non ti informeremo più se sono presenti aggiornamenti tecnologici o software sul nostro prodotto.

ISTRUZIONI SICURE

ATTENZIONE: leggere attentamente le istruzioni e le procedure per operazioni in sicurezza. In caso contrario, si possono verificare gravi conseguenze



lesioni.AVVERTENZA:

1. Prima di utilizzare il corrimano, assicurarsi che il corrimano sia installato in modo sicuro per evitare lesioni personali e incidenti.
2. Quando si utilizza il corrimano, non sovraccaricare il corrimano per evitare lesioni personali o incidenti.
3. Non disegnare, tagliare o utilizzare oggetti appuntiti sul corrimano per evitare danni.
4. Se è necessario smontare il corrimano, seguire le istruzioni eseguire i passaggi inversi per smontarlo e conservarlo correttamente.
5. Questo prodotto non è un giocattolo. Non permettere ai bambini di giocare con questo articolo.









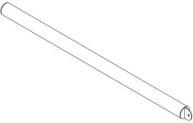

PRECAUZIONI DI MONTAGGIO

1. Assemblare solo secondo queste istruzioni.
Un montaggio improprio può creare pericoli.
2. Indossare occhiali di sicurezza approvati ANSI e per carichi pesanti guanti da lavoro durante il montaggio.
3. Mantenere l'area di assemblaggio pulita e ben illuminata.
4. Tenere gli astanti lontani dall'area durante l'assemblaggio.
5. Non montare in caso di stanchezza o sotto l'influenza di alcol, droghe o farmaci.
6. Le funzionalità del prodotto si applicano correttamente e completamente solo prodotti assemblati.
7. Per ulteriori informazioni riguardanti le parti elencate in
Nelle pagine seguenti si rinvia all'Assemblea
Schema di questo manuale. Scartare e separare tutte le parti
in un'area di lavoro pulita.
8. Per motivi di sicurezza, si consiglia di utilizzare questo hardware
essere installato da 2 persone.

CONSERVA QUESTE ISTRUZIONI

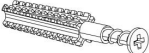
Modello	Lunghezza del corrimano (mm)
BX-80	800
BX-100	1000
BX-120	1200

COMPONENTI

NO.	Nome	Immagine	QUANTITÀ.
UN	Pilastro		1
B	Decorativo Copertina		1
C	Regolabile Supporto		1
D	Corrimano		1
E	Parte fissa		1
F	Vite M6*16		2
G	Dado M6		2
	Bullone di espansione H		8
.	Chiave inglese		1
J	Chiave esagonale		2
K	Punta da trapano		1

I	Pagliette		1
---	-----------	---	---

PASSO 1:

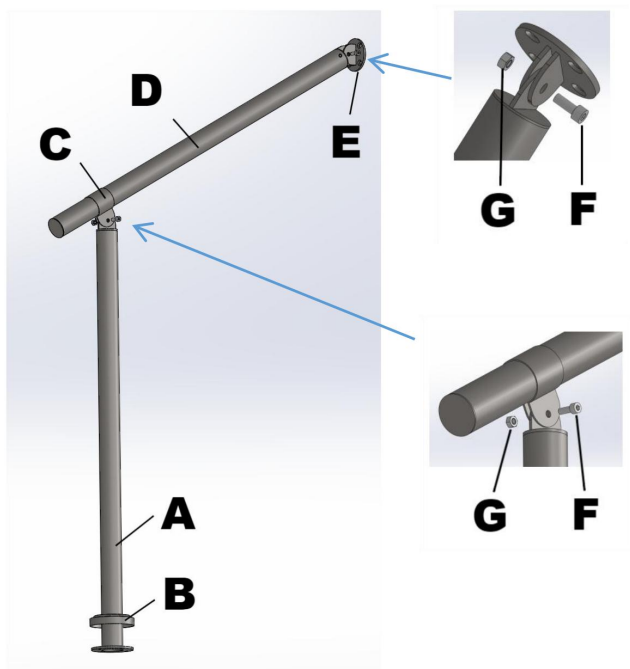

PASSO 2:

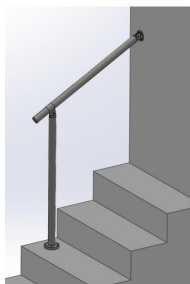

PASSO 3:

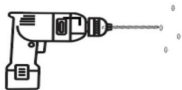
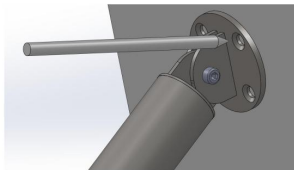

PASSO 4:

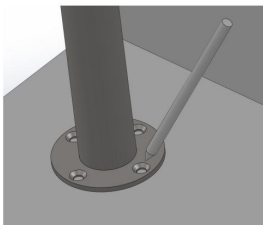

PASSO 5:

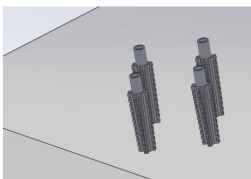
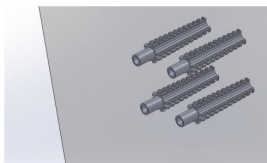

PASSO 6:

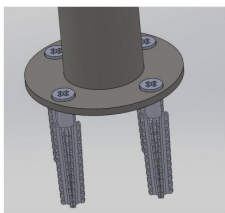
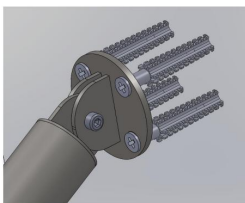

PASSO 7:

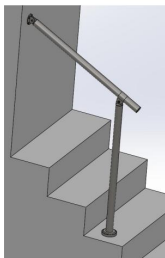

Produttore: Shanghaimuxinmuyeyouxiangongsi **Indirizzo:**

Shuangchenglu

803nong11hao1602A-1609shi, baoshanqu, shanghai 200000 CN.

Importato in AUS: SIHAO PTY LTD. 1 ROKEVA

STREETEASTWOOD NSW 2122 Australia

Importato negli Stati Uniti: Sanven Technology Ltd. Suite 250,

9166 Anaheim Place, Rancho Cucamonga, CA 91730



YH CONSULTING LIMITED.

C/O YH Consulting Limited Office 147,

Centurion House, London Road,

Staines-upon-Thames, Surrey, TW18 4AX



E-CrossStu GmbH

Mainzer Landstr.69,

60329 Frankfurt am Main.

VEVOR[®]

TOUGH TOOLS, HALF PRICE

Supporto tecnico e certificato di garanzia

elettronica www.vevor.com/support

VEVOR®

TOUGH TOOLS, HALF PRICE

Soporte técnico y certificado de garantía electrónica

www.vevor.com/support

PASAMANOS DE ACERO INOXIDABLE

MODELO: BX-80 \ BX-100 \ BX-120

Seguimos comprometidos a proporcionarle herramientas a precios competitivos. "Ahorre a mitad de precio", "A mitad de precio" o cualquier otra expresión similar utilizada por nosotros solo representa una estimación de los ahorros que podría beneficiarse al comprar ciertas herramientas con nosotros en comparación con las principales marcas y no significa necesariamente cubrir todas las categorías de herramientas ofrecidas. por nosotros. Le recordamos que, cuando realice un pedido con nosotros, verifique cuidadosamente si realmente está ahorrando la mitad en comparación con las principales mar

VEVOR[®]
TOUGH TOOLS, HALF PRICE

ACERO INOXIDABLE
PRETIL

MODELO: BX-80 \ BX-100 \ BX-120

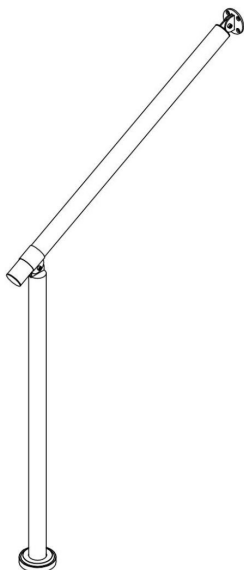

¿NECESITAS AYUDA? ¡CONTÁCTENOS!

¿Tiene preguntas sobre el producto? ¿Necesita soporte técnico?
Siéntete libre de contactarnos:

Soporte técnico y certificado de garantía electrónica
www.vevor.com/support

Estas son las instrucciones originales; lea atentamente todas las instrucciones del manual antes de operar. VEVOR se reserva una interpretación clara de nuestro manual de usuario. La apariencia del producto estará sujeta al producto que recibió. Perdón que no le informaremos nuevamente si hay actualizaciones de tecnología o software en nuestro producto.

INSTRUCCIONES DE SEGURIDAD

PRECAUCIÓN: Lea atentamente las instrucciones y procedimientos. para operaciones seguras. No hacerlo puede resultar en graves



lesiones. **ADVERTENCIA:**

1. Antes de usar el pasamano, asegúrese de que esté instalado de forma segura para evitar lesiones personales y accidentes.
2. Cuando utilice el pasamano, no lo sobrecargue. para evitar lesiones personales o accidentes.
3. No dibuje, corte ni utilice objetos afilados en el pasamanos. para evitar daños.
4. Si necesita desmontar el pasamanos, siga siga los pasos inversos para desmontarlo y guardarlo correctamente.
5. Este producto no es un juguete. No permita que los niños jueguen. con este artículo.









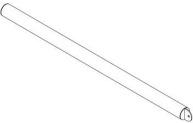

PRECAUCIONES DE MONTAJE

1. Ensamble únicamente de acuerdo con estas instrucciones. Un montaje inadecuado puede crear peligros.
2. Utilice gafas de seguridad aprobadas por ANSI y gafas guantes de trabajo durante el montaje.
3. Mantenga el área de reunión limpia y bien iluminada.
4. Mantenga a las personas transeúntes fuera del área durante el montaje.
5. No se reúna cuando esté cansado o bajo la influencia de alcohol, drogas o medicamentos.
6. Las capacidades del producto se aplican de forma adecuada y completa. Productos ensamblados únicamente.
7. Para obtener información adicional sobre las piezas enumeradas en las siguientes páginas, consulte la Asamblea Diagrama de este manual. Desenvolver y separar todas las piezas. en un área de trabajo limpia.
8. Por razones de seguridad, se recomienda este hardware para Ser instalado por 2 personas.

GUARDA ESTAS INSTRUCCIONES

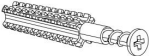
Modelo	Longitud del pasamano (mm)
BX-80	800
BX-100	1000
BX-120	1200

COMPONENTES

No.	Nombre	Imagen	CANT.
A	Pilar		1
B	Decorativo Cubrir		1
C	Ajustable Apoyo		1
D	Pretil		1
Y	Parte fija		1
	Tornillo F M6*16		2
	Tuerca M6		2
	Perno de expansión H		8
l	Llave inglesa		1
j	Llave hexagonal		2
k	Broca		1

I	Estropajo		1
---	-----------	---	---

PASO 1:

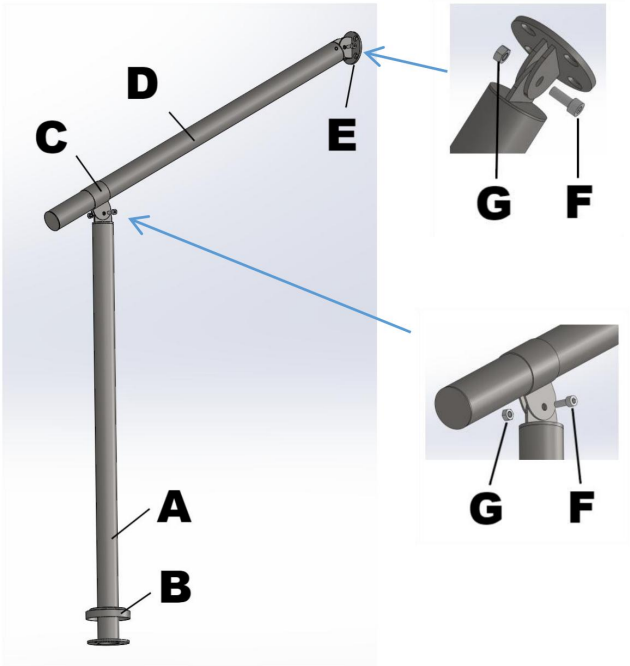

PASO 2:

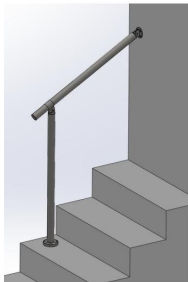

PASO 3:

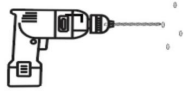
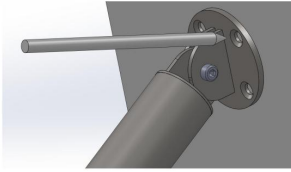

ETAPA 4:

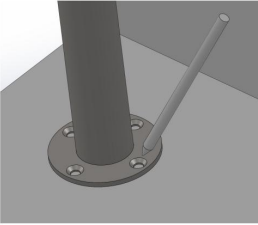

PASO 5:

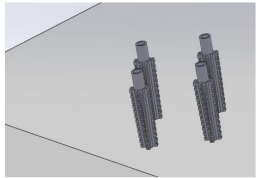
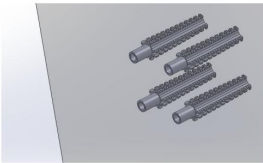

PASO 6:

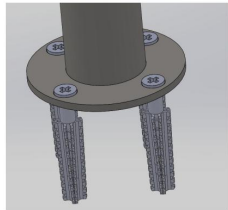
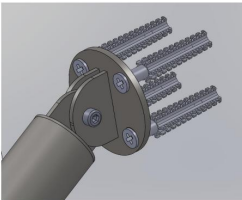

PASO 7:

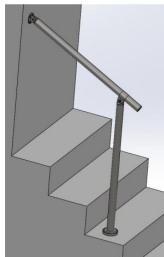

Fabricante: Shanghaimuxinmuyeyouxiangongsi Dirección:
Shuangchenglu
803nong11hao1602A-1609shi, baoshanqu, shanghai 200000 CN.

Importado a AUS: SIHAO PTY LTD. 1 ROKEVA
STREETASTWOOD NSW 2122 Australia

Importado a EE. UU.: Sanven Technology Ltd. Suite 250, 9166
Anaheim Place, Rancho Cucamonga, CA 91730



YH CONSULTING LIMITED.
C/O YH Consulting Limited Office 147,
Centurion House, London Road,
Staines-upon-Thames, Surrey, TW18 4AX



E-CrossStu GmbH
Mainzer Landstr.69,
60329 Frankfurt am Main.

VEVOR[®]

TOUGH TOOLS, HALF PRICE

Soporte técnico y certificado de garantía
electrónica www.vevor.com/support

VEVOR[®]

TOUGH TOOLS, HALF PRICE

Wsparcie techniczne i certyfikat e-gwarancji

www.vevor.com/support

PORĘCZ ZE STALI NIERDZEWNEJ

MODEL: BX-80 \ BX-100 \ BX-120

Nadal dokładamy wszelkich starań, aby zapewnić Państwu narzędzia w konkurencyjnej cenie. „Zaoszczędź połowę”, „połowa ceny” lub inne podobne wyrażenia używane przez nas przedstawiają jedynie szacunkową oszczędność, jaką możesz zyskać kupując u nas określone narzędzia w porównaniu z głównymi najlepszymi markami i niekoniecznie oznaczają uwzględnienie wszystkich kategorii oferowanych narzędzi przez nas. Przypominamy, aby podczas składania zamówienia u nas dokładnie sprawdzić, czy rzeczywiście oszczędzasz połowę w porównaniu z czołowym

VEVOR[®]
TOUGH TOOLS, HALF PRICE

STAL NIERDZEWNA
PORĘCZ

MODEL: BX-80 \ BX-100 \ BX-120

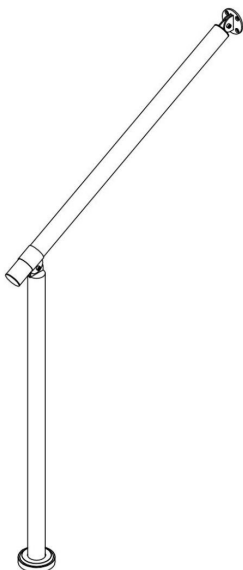

POTRZEBUJĘ POMOCY? SKONTAKTUJ SIĘ Z NAMI!

Masz pytania dotyczące produktu? Potrzebujesz wsparcia technicznego?
Śmiało możesz się z nami skontaktować:

Wsparcie techniczne i certyfikat e-gwarancji
www.vevor.com/support

To jest oryginalna instrukcja. Przed przystąpieniem do obsługi prosimy o dokładne zapoznanie się ze wszystkimi instrukcjami. VEVOR zastrzega sobie jasną interpretację naszej instrukcji obsługi. Wygląd produktu zależy od produktu, który otrzymałeś. Proszę wybaczyć nam, że nie będziemy ponownie informować Państwa, jeśli pojawią się jakieś aktualizacje technologii lub oprogramowania naszego produktu.

BEZPIECZNE INSTRUKCJE

UWAGA: Przeczytaj uważnie instrukcje i procedury dla bezpiecznych operacji. Niezastosowanie się do tego może skutkować poważnymi



obrażenia. OSTRZEŻENIE:

1. Przed użyciem poręczy należy upewnić się, że poręcz jest zamontowana bezpiecznie zainstalowany, aby zapobiec obrażeniom ciała i wypadki.
2. Podczas korzystania z poręczy nie przeciążaj poręczy aby uniknąć obrażeń ciała lub wypadku.
3. Nie rysuj, nie przecinaj ani nie używaj ostrych przedmiotów na poręcz aby uniknąć uszkodzeń.
4. Jeśli chcesz zdemontować poręcz, postępuj zgodnie z instrukcjami należy wykonać odwrotne kroki, aby zdemontować i prawidłowo przechowywać.
5. Ten produkt nie jest zabawką. Nie pozwalaj dzieciom bawić się z tym przedmiotem.









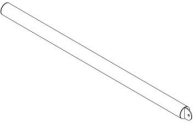

ŚRODKI OSTROŻNOŚCI PRZY MONTAŻU

1. Montaż wyłącznie zgodnie z niniejszą instrukcją. Nieprawidłowy montaż może stworzyć zagrożenie.
2. Nosić okulary ochronne o dużej wytrzymałości, zatwierdzone przez ANSI rękawice robocze podczas montażu.
3. Utrzymuj miejsce montażu w czystości i dobrze oświetlone.
4. Podczas montażu trzymaj osoby postronne z dala od obszaru.
5. Nie montuj będąc zmęczonym lub pod wpływem alkoholu, narkotyki lub leki.
6. Możliwości produktu dotyczą prawidłowo i całkowicie wyłącznie produkty zmontowane.
7. Aby uzyskać dodatkowe informacje dotyczące części wymienionych w na kolejnych stronach, prosimy zapoznać się ze Zgromadzeniem Schemat tej instrukcji. Rozwiń i oddziel wszystkie części w czystym miejscu pracy.
8. Ze względów bezpieczeństwa zaleca się stosowanie tego sprzętu być instalowane przez 2 osoby.

ZACHOWAJ TE INSTRUKCJE

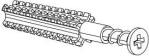
Model	Długość poręczy (mm)
BX-80	800
BX-100	1000
BX-120	1200

SKŁADNIKI

NIE.	Nazwa	Zdjęcie	ILOŚĆ.
A	Filar		1
B	Dekoracyjny Okładka		1
C	Nastawny Wsparcie		1
D	Poręcz		1
I	Część stała		1
F	Śruba M6*16		2
G	Nakrętka M6		2
H	Śruba rozporowa		8
I	Klucz		1
J	Klucz sześciokątny		2
K	Wiertło		1

L	Podkładka do szorowania		1
---	-------------------------	---	---

KROK 1:

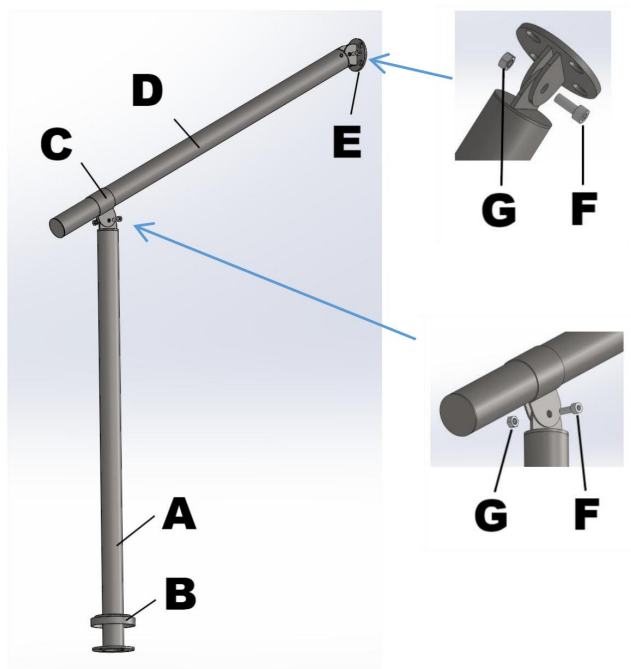

KROK 2:

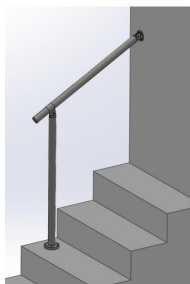

KROK 3:

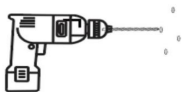
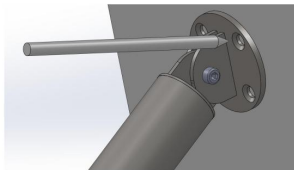

KROK 4:

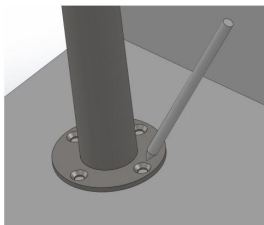

KROK 5:

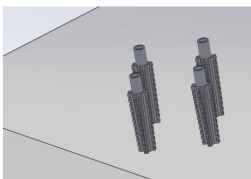
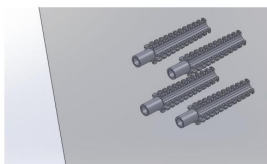

KROK 6:

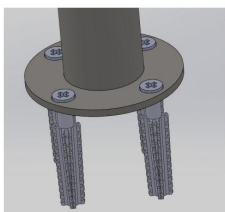
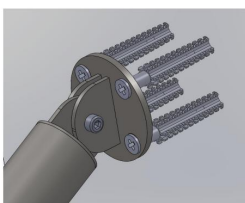

KROK 7:

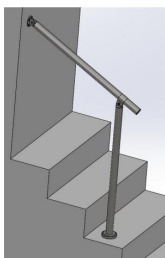

Producent: Shanghaimuxinmuyeyouxiangongsi Adres:

Shuangchenglu

803nong11hao1602A-1609shi, baoshanqu, szanghaj 200000 CN.

Import do AUS: SIHAO PTY LTD. 1 ROKEVA STREETEASTWOOD

NSW 2122 Australia

Import do USA: Sanven Technology Ltd. Suite 250, 9166 Anaheim

Place, Rancho Cucamonga, CA 91730



YH CONSULTING LIMITED.

C/O YH Consulting Limited Office 147,

Centurion House, London Road,

Staines-upon-Thames, Surrey, TW18 4AX



E-CrossStu GmbH

Mainzer Landstr.69,

60329 Frankfurt am Main.

VEVOR[®]

TOUGH TOOLS, HALF PRICE

Wsparcie techniczne i certyfikat e-gwarancji

www.vevor.com/support

VEVOR[®]

TOUGH TOOLS, HALF PRICE

Technische ondersteuning en e-garantiecertificaat

www.vevor.com/support

ROESTVRIJ STALEN LEUNING

MODEL: BX-80 \ BX-100 \ BX-120

We blijven ons inzetten om u gereedschap tegen een concurrerende prijs te bieden. 'Bespaar de helft', 'Halve prijs' of andere soortgelijke uitdrukkingen die door ons worden gebruikt vertegenwoordigen slechts een schatting van de besparingen die u zou kunnen profiteren als u bepaalde gereedschappen bij ons koopt in vergelijking met de grote topmerken en betekenen niet noodzakelijkerwijs dat ze alle aangeboden categorieën gereedschappen dekken. door ons. U wordt er vriendelijk aan herinnerd om bij het plaatsen van een bestelling bij ons zorgvuldig te verifiëren of u daadwerkelijk de helft bespaart in vergelijking met de g

VEVOR[®]
TOUGH TOOLS, HALF PRICE

ROESTVRIJ STAAL
LEUNING

MODEL: BX-80 \ BX-100 \ BX-120

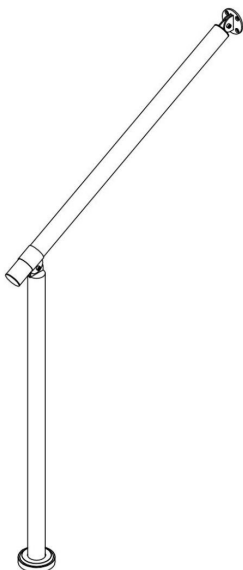

HULP NODIG? NEEM CONTACT MET ONS OP!

Heeft u productvragen? Technische ondersteuning nodig?
Neem dan gerust contact met ons op:

Technische ondersteuning en e-garantiecertificaat
www.vevor.com/support

Dit is de originele instructie. Lees alle handleidingen zorgvuldig door voordat u ermee aan de slag gaat. VEVOR behoudt zich een duidelijke interpretatie van onze gebruikershandleiding voor. Het uiterlijk van het product is afhankelijk van het product dat u heeft ontvangen. Vergeef ons alstublieft dat we u niet opnieuw informeren als er technologie- of software-updates zijn voor ons product.

VEILIGE INSTRUCTIES

LET OP: Lees de instructies en procedures zorgvuldig door voor veilige operaties. Als u dit niet doet, kan dit ernstige gevolgen hebben



letsel. WAARSCHUWING:

1. Zorg ervoor dat de leuning goed is voordat u de leuning gebruikt veilig geïnstalleerd om persoonlijk letsel te voorkomen en ongelukken.
2. Wanneer u de leuning gebruikt, overbelast de leuning dan niet om persoonlijk letsel of ongelukken te voorkomen.
3. Teken, snij of gebruik geen scherpe voorwerpen op de leuning om schade te voorkomen.
4. Volg onderstaande stappen als u de leuning moet demonteren voer de omgekeerde stappen uit om het te demonteren en op de juiste manier op te slaan.
5. Dit product is geen speelgoed. Laat kinderen niet spelen met dit artikel.









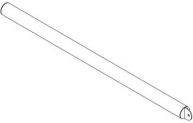

MONTAGEVOORZORGSMAATREGELEN

1. Monteer uitsluitend volgens deze instructies.
Onjuiste montage kan gevaren veroorzaken.
2. Draag een ANSI-goedgekeurde veiligheidsbril en een zware veiligheidsbril werkhandschoenen tijdens de montage.
3. Houd de verzamelplaats schoon en goed verlicht.
4. Houd omstanders tijdens de montage uit de buurt.
5. Niet monteren als u moe bent of onder invloed bent alcohol, drugs of medicijnen.
6. Productmogelijkheden zijn correct en volledig van toepassing uitsluitend samengestelde producten.
7. Voor aanvullende informatie over de onderdelen vermeld in de volgende pagina's, verwijzen wij u naar de Algemene Vergadering Diagram van deze handleiding. Haal alle onderdelen uit de verpakking en scheid ze in een schone werkomgeving.
8. Om veiligheidsredenen wordt deze hardware aanbevolen door 2 personen geïnstalleerd worden.

BEWAAR DEZE INSTRUCTIES

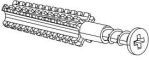
Model	Lengte van leuning (mm)
BX-80	800
BX-100	1000
BX-120	1200

COMPONENTEN

Nee.	Naam	Afbeelding	AANTAL.
A	Pijler		1
B	Decoratief Omslag		1
C	Verstelbaar Steun		1
D	Leuning		1
EN	Vast onderdeel		1
F	Schroef M6*16		2
G	Moer M6		2
H	Expansiebout		8
I	Moersleutel		1
J	Inbussleutel		2
K	Boor		1

L	Schuursponsje		1
---	---------------	---	---

STAP 1:

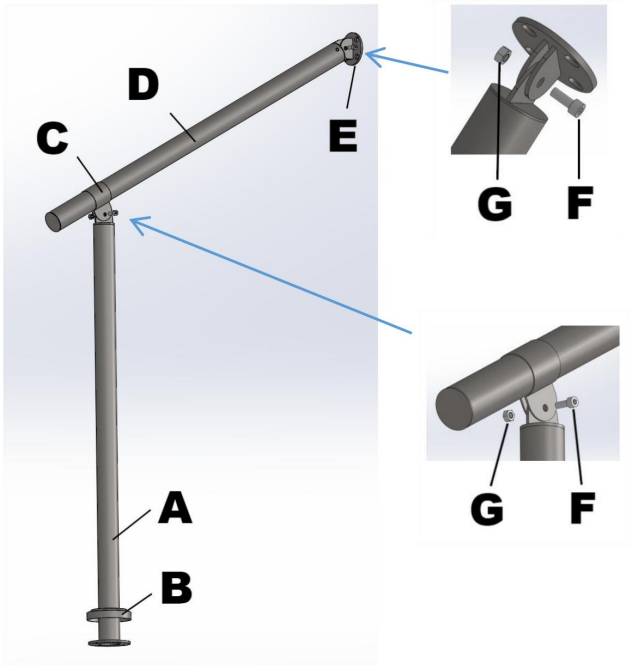

STAP 2:

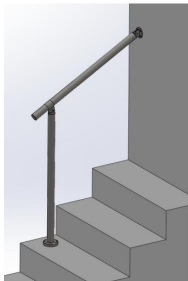

STAP 3:

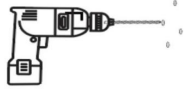
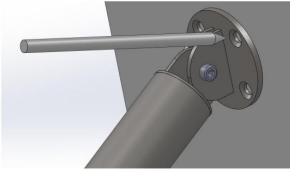

STAP 4:

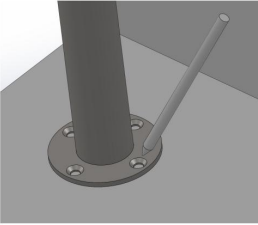

STAP 5:

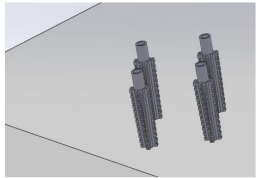
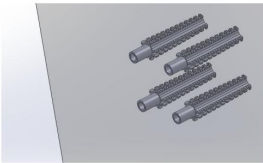

STAP 6:

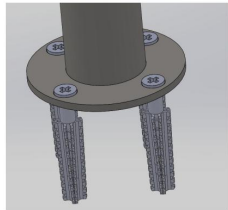
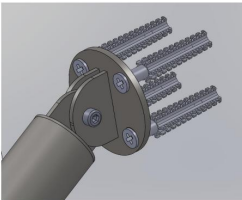

STAP 7:

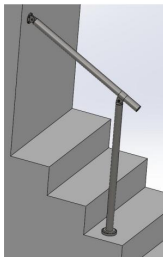

Fabrikant: Shanghaimuxinmuyeyouxiangongsi **Adres:**

Shuangchenglu

803nong11hao1602A-1609shi, baoshanqu, shanghai 200000 CN.

Geïmporteerd naar AUS: SIHAO PTY LTD. 1 ROKEVA

STREETEASTWOOD NSW 2122 Australië

Geïmporteerd naar de VS: Sanven Technology Ltd. Suite 250,

9166 Anaheim Place, Rancho Cucamonga, CA 91730



YH CONSULTING LIMITED.

C/O YH Consulting Limited Office 147,

Centurion House, London Road,

Staines-upon-Thames, Surrey, TW18 4AX



E-CrossStu GmbH

Mainzer Landstr.69,

60329 Frankfurt am Main.

VEVOR[®]

TOUGH TOOLS, HALF PRICE

Technische ondersteuning en e-
garantiecertificaat www.vevor.com/support

VEVOR[®]

TOUGH TOOLS, HALF PRICE

Teknisk support och e-garanticertifikat

www.vevor.com/support

ROSTFRITT STÅL RÄKKE

MODELL: BX-80 \ BX-100 \ BX-120

Vi fortsätter att vara engagerade i att ge dig verktyg till konkurrenskraftiga priser. "Spara hälften", "halva priset" eller andra liknande uttryck som används av oss representerar bara en uppskattning av besparingar du kan dra nytta av att köpa vissa verktyg hos oss jämfört med de stora toppmärkena och betyder inte nödvändigtvis att täcka alla kategorier av verktyg som erbjuds av oss. Du påminns vänligen om att noggrant kontrollera när du gör en beställning hos oss om du faktiskt sparar hälften i jämförelse med de främsta stora varumärkena

VEVOR[®]
TOUGH TOOLS, HALF PRICE

ROSTFRITT STÅL
LEDSTÅNG

MODELL: BX-80 \ BX-100 \ BX-120

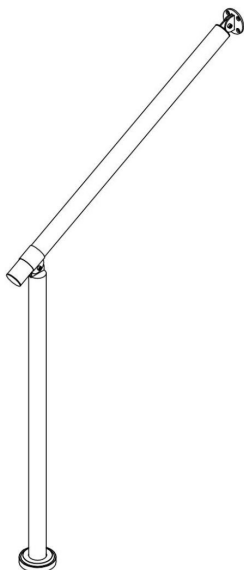

BEHÖVS HJÄLP? KONTAKTA OSS!

Har du produktfrågor? Behöver du teknisk support?

Kontakta oss gärna:

Teknisk support och e-garanticertifikat
www.vevor.com/support

Detta är den ursprungliga instruktionen, läs alla instruktioner noggrant innan du använder den. VEVOR reserverar sig för en tydlig tolkning av vår användarmanual. Utseendet på produkten är beroende av den produkt du fått.

Ursäkta oss att vi inte kommer att informera dig igen om det finns någon teknik eller mjukvaruuppdateringar på vår produkt.

SÄKERHETSINSTRUKTIONER

VARNING: Läs instruktionerna och procedurerna noggrant för säker verksamhet. Underlåtenhet att göra det kan leda till allvarliga konsekvenser



skada. VARNING:

1. Innan du använder ledstången, se till att ledstången är säkert installerat för att förhindra personskador och olyckor.
2. När du använder ledstången, överbelasta inte ledstången för att undvika personskador eller olyckor.
3. Rita, skär eller använd inte vassa föremål på ledstången för att undvika skador.
4. Om du behöver ta isär ledstången, vänligen följ de omvända stegen för att ta isär och förvara den på rätt sätt.
5. Denna produkt är inte en leksak. Låt inte barn leka med detta föremål.









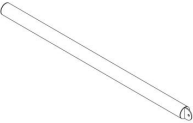

FÖRSIKTIGHETSÅTGÄRDER FÖR MONTERING

1. Montera endast enligt dessa instruktioner.
Felaktig montering kan skapa faror.
2. Bär ANSI-godkända skyddsglasögon och kraftiga skyddsglasögon arbetshandskar vid montering.
3. Håll monteringsområdet rent och väl upplyst.
4. Håll åskådare borta från området under monteringen.
5. Montera inte när du är trött eller påverkad av alkohol, droger eller mediciner.
6. Produktens kapacitet gäller korrekt och fullständigt endast sammansatta produkter.
7. För ytterligare information om delarna som listas i på följande sidor, hänvisa till församlingen Diagram över denna manual. Packa upp och separera alla delar i ett rent arbetsområde.
8. Av säkerhetsskäl rekommenderas denna hårdvara att installeras av 2 personer.

SPARA DESSA INSTRUKTIONER

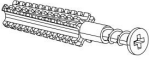
Modell	Ledstångens längd (mm)
BX-80	800
BX-100	1000
BX-120	1200

KOMPONENTER

Nej.	namn	Bild	ANTAL.
A	Pelare		1
B	Dekorativ Omslag		1
C	Justerbar Stöd		1
D	Ledstång		1
OCH	Fast del		1
F	Skruv M6*16		2
G	Mutter M6		2
H	Expansionsbult		8
.	Rycka		1
J	Insexnyckel		2
K	Borr		1

L	Skurdyna		1
---	----------	---	---

STEG 1:

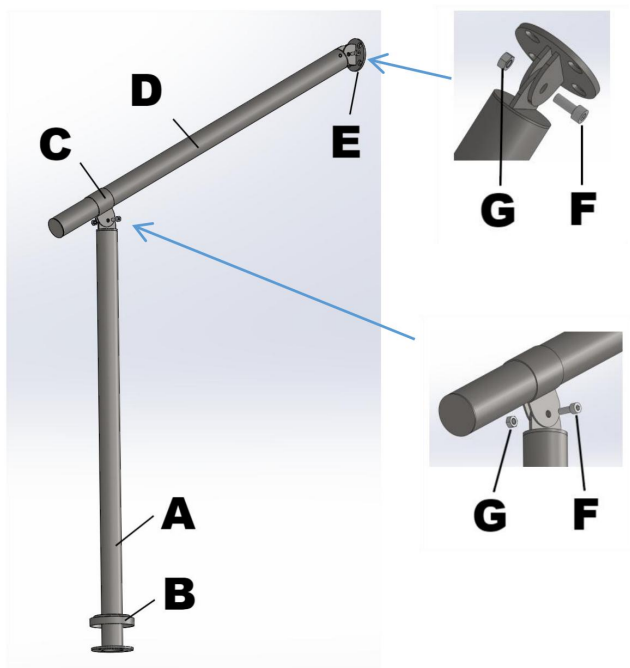

STEG 2:

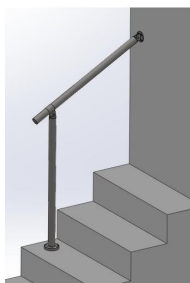

STEG 3:

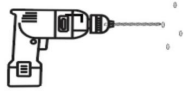
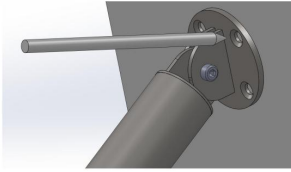

STEP 4:

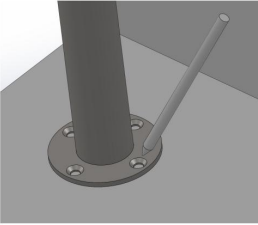

STEP 5:

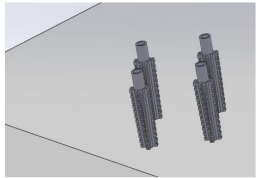
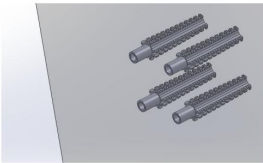

STEP 6:

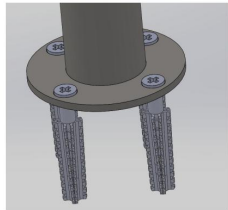
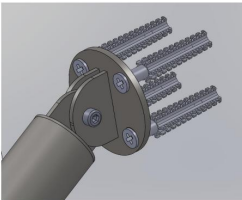

STEP 7:

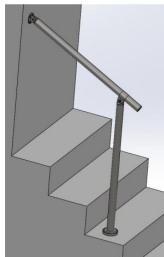

Tillverkare: Shanghaimuxinmuyeyouxiangongsi **Adress:**

Shuangchenglu

803nong11hao1602A-1609shi, baoshanqu, shanghai 200000 CN.

Importerad till AUS: SIHAO PTY LTD. 1 ROKEVA

STREETEASTWOOD NSW 2122 Australien

Importerad till USA: Sanven Technology Ltd. Suite 250, 9166

Anaheim Place, Rancho Cucamonga, CA 91730



YH CONSULTING LIMITED.

C/O YH Consulting Limited Office 147,

Centurion House, London Road,

Staines-upon-Thames, Surrey, TW18 4AX



E-CrossStu GmbH

Mainzer Landstr.69,

60329 Frankfurt am Main.

VEVOR[®]

TOUGH TOOLS, HALF PRICE

Teknisk support och e-garanticertifikat

www.vevor.com/support