

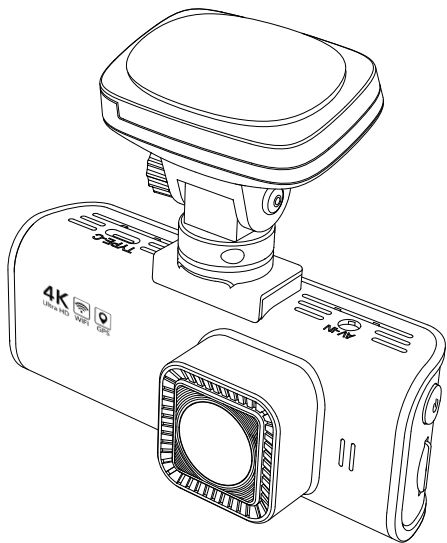

V1.1

# REDTIGER

Truly Peace of Mind™



## F7N Pro User Manual

[redtigercam.com](http://redtigercam.com)

The information in this manual is subject to change without notice.

# Content

Notice . . . . .	<b>2</b>
Product Specifications . . . . .	<b>3</b>
Package Contents . . . . .	<b>4</b>
Appearance . . . . .	<b>5</b>
Buttons and Functions . . . . .	<b>6</b>
User Interface Overview . . . . .	<b>8</b>
Function Overview . . . . .	<b>11</b>
Over-The-Air Updates . . . . .	<b>14</b>
How to Play Video on Computer . . . . .	<b>14</b>
Installation . . . . .	<b>16</b>
Troubleshooting . . . . .	<b>20</b>
Customer Service Center . . . . .	<b>22</b>

## Notice

- Please read this manual carefully before operation and keep it for future reference. It will be helpful should you encounter any operational problems.
- Improper installation will void the manufacturer's warranty. The installation instructions do not apply to all types of vehicles and are written as guidelines to assist in installing the system.
- Consult with an experienced technician if you are not comfortable installing the device on your own.
- Please make sure to read and understand local laws and regulations regarding cameras and their use in a vehicle. Laws may vary by state.
- Do not obscure the view of the road ahead or obstruct the deployment of any airbags in the event of an accident.
- When not in use, please disconnect the car adapter from both the 12/24V DC outlet in your vehicle and the device itself.
- Only clean the device with a soft dry cloth, for tough dirt, apply some neutral detergent diluted in 5 to 6 parts water on a soft cloth.
- Note that alcohol, thinner, benzene, etc. could cause damage to the paint or coatings on the device.
- Avoid making contact with the lens as this may cause damage.
- The video recordings made by this device are intended for personal use only.
- While driving, do not adjust the controls of your device, as it may draw your attention from your surroundings.

## Product Specifications

Item Name	F7N Pro Dash Cam	Video Format	MP4
Screen Size	3.18" IPS Screen	Photo Format	JPG
Recording Resolution	Front 2160P+Rear1080P		
Input	DC 5V-2.5A	Lens	Front cam F1.8 Rear camera F2.0
Operating Temperature	-4°F~158°F		
Memory Card	32GB-256GB	Warranty Period	18 months

### Note:

If you have any problems during use, we will provide free device replacement within 18 months of purchase, in addition to lifetime technical support.

### Extended Warranty Service:

You may also receive an additional 6 months of extended warranty service by registering your device on our website.

URL: <https://www.redtigercam.com/pages/warranty-form>

## Package Contents

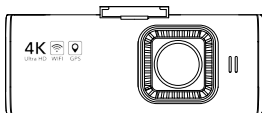

- F7N Pro 4K Dash Cam

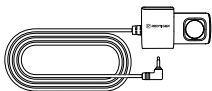

- 1080P Rear Camera



- GPS Mount

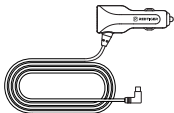

- Power Supply Cable with Car Charger



- Rear Cam Cable



- Adhesive

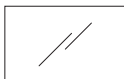

- Electrostatic Sticker \*2



- Cable Clips\*5



- User Manual



- Tool

## Appearance

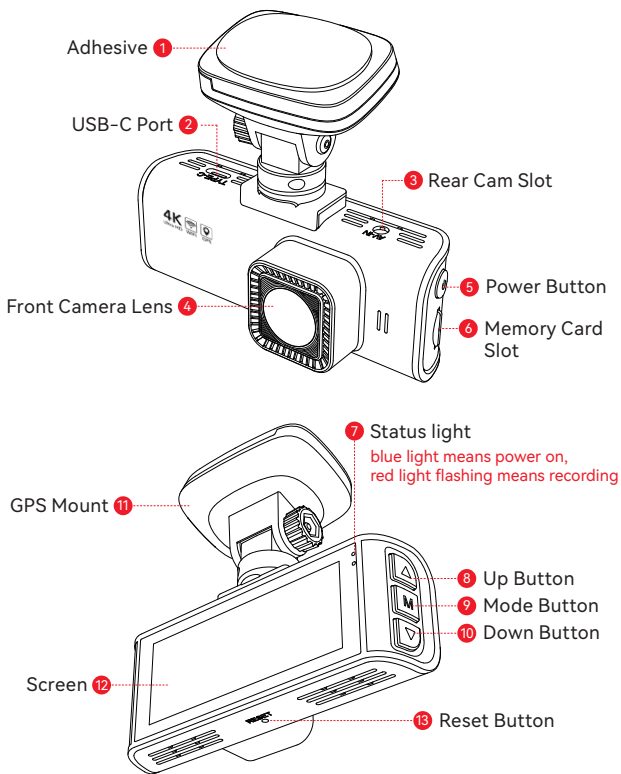

## Buttons and Functions



### Power Button

Recording Mode:

- Short press-to Switch screen
- Long press-to Turn off the Camera

Setup Mode:

- Short press-to Return to the previous screen

Playback Mode:

- Short press-to Return to the previous screen



### Menu Button

Recording Mode:

- Short press to Enter main menu

Setup Mode:

- Short press-to Enter/Confirm specific settings

Playback Mode:

- Short press-to Select and play the specific file
- Long press-to Delete/Lock/Unlock the specific file



### Up Button

Recording Mode:

- Short press-to Lock the recording file
- Long press-to Turn on or off Wi-Fi

Setup Mode:

- Short press-to Select the previous function

Playback Mode:

- Short press-to Select the previous file
- Short press-to Fast rewind (while video is playing)



## **Down Button**

### Recording Mode:

- Short press-to Take a snapshot
- Long press-to Stop recording

### Setup Mode:

- Short press-to Select the next function







### Playback Mode:

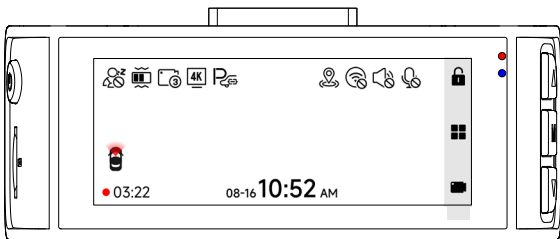





- Short press-to Select the next file
- Short press-to Fast forward (while video is playing)

# User Interface Overview

## • Recording Mode



Icon	Description
	Fatigue driving function is on
	G-Sensor sensitivity
	Loop recording in 1 min/3 mins/5 mins per file
	Recording resolution
	Whether to connect the hardwired kit and set up parking monitoring
	GPS status
	Wi-Fi status

Icon	Description
	Camera system sound status
	Voice recording status
	Whether the rear camera is connected
● 03:22	Recording status and recording time
● 03:22	Emergency recording is on
08-16 10:52 AM	Date and time of the camera
	Emergency Video Lock
	Enter the menu
	Photograph function
●	Power Indicator
●	Red led blinking: Recording Video /No Red led: Not Recording Video

## • Playback Mode

- 1 Press the M button to enter Playback mode.
- 2 Press the Up or Down button to select the folder you want to play, then press the M button to enter.

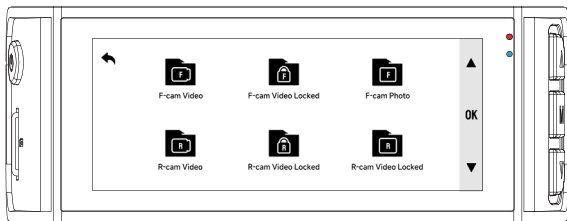



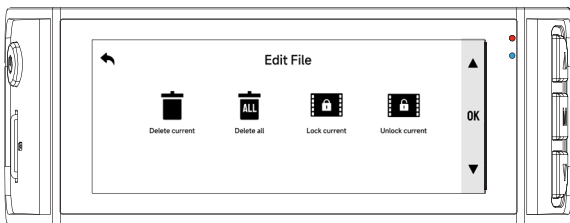



















- 3 Press the M button to watch the recorded video.
- 4 Long press the M button for 3 seconds to edit your recorded videos.









## Function Overview

Short press M button to enter settings menu, where you can adjust various functions and parameters of the entire machine.

Icon	Function	Option/Description
	Resolution	2160P @30fps/1440P @60fps/1080P @120fps
	Audio	Sound Recording
	Date Stamp	ON/OFF
	Loop recording	1/3/5mins
	G-sensor	Off/Low/Medium/High
	Fatigue Driving	A Reminder Will be Made During 1h/2h/3h/4h/OFF
	Speed Stamp	ON/OFF
	GPS Stamp	ON/OFF
	Speed Units	KMH/MPH
	GPS Info	Display GPS signal strength

Icon	Function	Option/Description
	Rear Cam Flip	Vertical Flip Your Rear View *Need to connect rear camera
	Mirror Flip	Horizontal Flip Your Rear View *Need to connect rear camera
	APP	A QR Code for Redtiger app
	Wi-Fi	ON/OFF
	Language	Choose Your Preferred Language
	Time Format	12h/24h
	Date / Time	Update With GPS
	Time Zone	Choose Your Time Zone
	DST	Daylight Saving Time ON/OFF
	Frequency	60Hz/50Hz
	Click Tone	ON/OFF
	Screen Saver	OFF/10s/30s/2mins, Screen goes off after the set time

Icon	Function	Option/Description
	Parking Mode	Please connect the ACC hardwire kit
	Format Reminder	Reminder to Clear Data
	Format	Format SD card. All data will be deleted
	Card Speed	Card Speed Detection
	Default Setting	Reset All Settings
	Version	Software Version
	Help Center	Scan the QR code to contact us

## Note:

- In order to a Clean, Smooth, Comfortable using experience, we suggest you format your Memory Card once a month.
- When you turn off Click Tone, the startup and shutdown sounds will also be turned off.

## Over-The-Air Updates

**Note:** Please update the Redtiger Cam App to the latest version to use this function.

1. To perform an over-the-air update, disconnect your phone from the dash cam's Wi-Fi network. Connect your phone to LAN (not the dash cam's Wi-Fi) for 5 seconds, then disconnect. Reconnect to the dash cam's Wi-Fi network.
2. Once Wi-Fi connection is successful, open the Redtiger Cam App to start using it. If new software is detected, the App page will indicate the availability of an update.
3. To perform the update, click on "Upgrade Now". The Redtiger Cam App will prompt you to download the update package.
4. Connect the dash cam to send the update package. Do not power off the dash cam during the upgrade process. Once the upgrade is completed, the app will display the upgrade success message, and the dash cam will automatically restart.

## How to Play Video on Computer

We recommend using REDTIGER Player as the correct video player to watch/play videos. It can also view Google Maps.

You can Download it for free on Mac or Windows from the following link: <https://www.redtigercam.com/pages/gps-player>

You can choose different playback modes in Settings > Video Playback Mode. You can set playback speed, language, map, and various other functions.

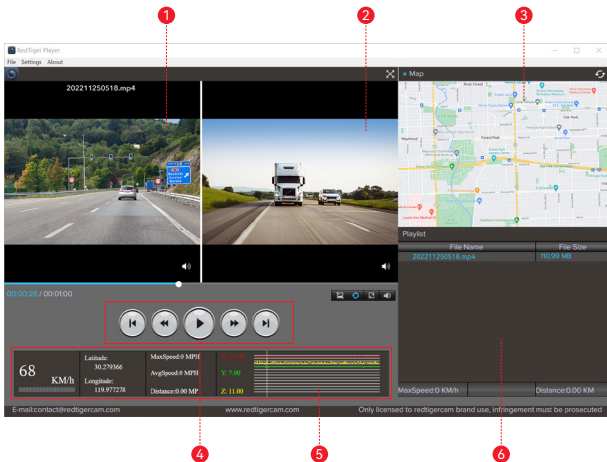

- ① Video play window (Front)
- ② Video play window (Rear)
- ③ Map and track display
- ④ Play control panel
- ⑤ Speed and driving state indication
- ⑥ Play list

### Note:

If the video files of front and rear road tracks are recorded synchronously and loaded into the playing list at the same time, they can be played separately in split left and right screens.

When you find the desired video file, hold down the left mouse button and drag the desired files to the video play window to play it.

## Installation

### **⚠ WARNING**

Please make sure to connect all cameras and wires before powering on the camera screen, otherwise the camera will not work properly. Please follow the instructions below for the first-time installation of the Redtiger dash cam.

Scan the QR code on the right to view the installation tutorial video.



### **• Insert Memory Card**

Insert the memory card into the dash cam, ensuring that it is oriented correctly so that the gold contacts are facing towards the screen of the dash cam. Push the memory card until it clicks into the slot.

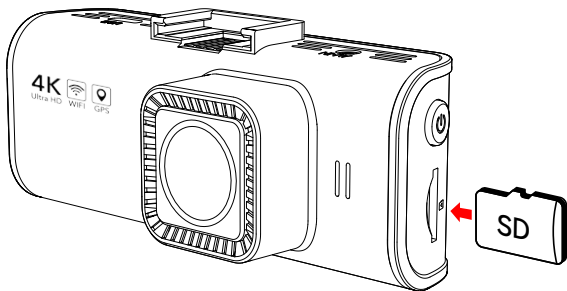

## • Front Camera Installation

Peel off the electrostatic sticker on the cellophane and transfer it to where you want to stick it. Attach the front camera to the electrostatic sticker and firmly press to secure it.

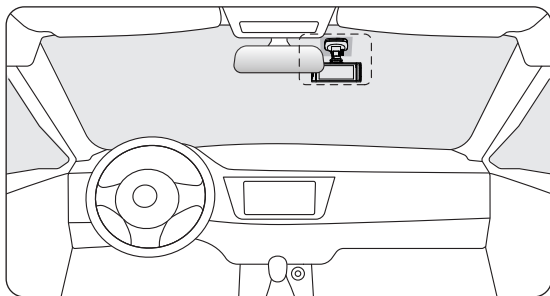
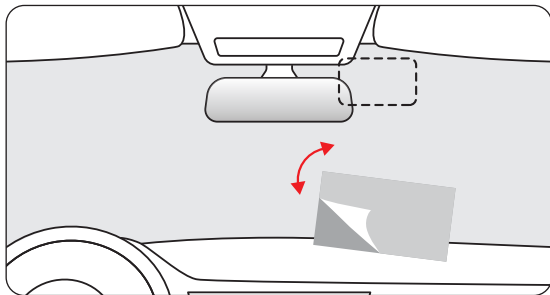

## • Mount The Rear Camera

- 1 Use a clean cloth to wipe the rear windshield where the rear camera needs to be installed.
- 2 Peel off the electrostatic sticker, transfer it to the place you want to stick it.
- 3 Drain the air bubbles on the electrostatic sticker.
- 4 Peel off the adhesive on the rear camera and stick it on the electrostatic sticker.

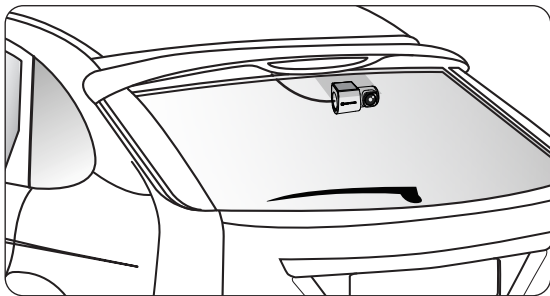

## • Wire Layout In The Vehicle

- 1 The car charger is connected to the cigar socket.
- 2 Connect the other end of the car charger to the dash cam.
- 3 Use the crowbar to run the power cable along the front windshield and the roof, and hide the cable down the A-pillar, so as not to block the driver's sight and cause danger.

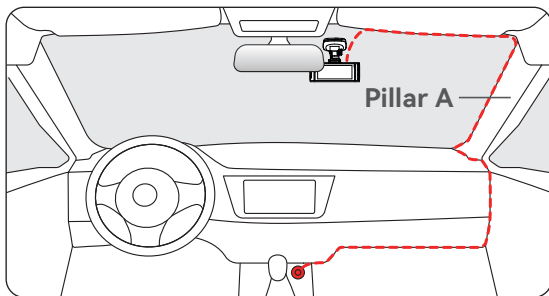

- 4 Connect the interface of the rear cable with the interface of the rear cam cable.
- 5 Hide the rear cam cable along the gaps between the front windshield and the ceiling, between the car body and the ceiling on the side of the passenger seat, and between the rear seats and the ceiling.

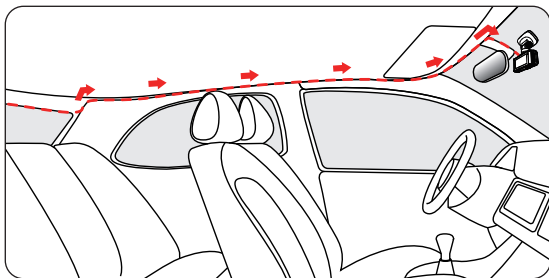

## Troubleshooting

### • Why is there no GPS signal?

1. Disconnect and clean the cable and port of any dust that may have accumulated around the dash cam. Check for any interference in your car, like metal film on the windshield, a radio antenna, or radar detector.
2. Move your car to an open area. Observe if the GPS icon on the screen turns green and displays GPS information.
3. Once the GPS locks on to a signal, a satellite icon will appear at the bottom left of the screen. Green indicates positioning, while white indicates no positioning.

### • How to turn off the on/off music of dash cam?

Please go to Settings > Click Tone > Off.

When the click tone is turned off, the power on and off music will also be turned off.

### • Why does my dash cam prompt “Card Error” or “Please Format Memory Card” occasionally?

Please follow the steps below to check:

1. Please go to Settings > Format Reminder to check whether the regular format reminder is enabled.
2. Format the Memory Card.
3. Restore factory settings and restart the dash cam.
4. Update the firmware.

### • Device restarts repeatedly/no boot?

1. Ensure you're using the included charger/cables.
2. Remove the memory card, camera cable, and car charger and reinstall them. Check if an issue was caused by the accessories.
3. Reset the device using the button at the bottom of the camera.

4. If the issue persists, connect the dash cam to a computer using a USB cable. If the device powers on, the issue may be caused by the car charger cable. If it does not power on while connected, there may be an issue with the dash cam itself.
5. Please go to the official website to update the firmware.
6. If it is not resolved, please contact our dedicated customer service for a replacement.

• **Why "Mass storage" appears on the screen?**

"Mass storage" happens when you use a USB cable with data transfer mode causing the dash cam to enter transfer mode. In this mode, data can only be transferred; no other functions work. For best results, use the original car charger or a USB cable without data transfer mode.

• **Why can't I connect to Wi-Fi?**

1. Check the working distance of Wi-Fi, about 15ft.
2. Check the SSID and password of the Wi-Fi, or whether there are other devices connected to the Wi-Fi.
3. Turn off mobile data, security software, and VPN on your phone.
4. If the issue persists, please contact customer support for assistance.

• **Why is the time setting incorrect?**

The dash cam features built-in GPS. It automatically adjusts time based on your location and time zone, eliminating the need for manual time changes. And you can adjust the time through Settings > Time Zone/DST.

## Customer Service Center

If you have any problems with the function or installation of your dash cam, please feel free to reach out to us.



Help Center



WhatsApp



### For more information:

After Sales: [help@redtigercam.com](mailto:help@redtigercam.com)

Business Cooperation: [contact@redtigercam.com](mailto:contact@redtigercam.com)

Customer Phone Service: +1 888 966 8028 (US)



#### IC warning:

This device contains licence-exempt transmitter(s)/receiver(s) that comply with Innovation Science and Economic Development Canada's licence-exempt RSS(s). Operation is subject to the following two conditions:

1. this device may not cause interference and
2. this device must accept any interference, including interference that may cause undesired operation of the device.

**Radiation Exposure:** This equipment complies with Canada radiation exposure limits set forth for an uncontrolled environment; To maintain compliance with IC's RF Exposure guidelines, This equipment should be installed and operated with minimum distance of 20cm the radiator your body. This device and its antenna(s) must not be co-located or operation in conjunction with any other antenna or transmitter.

#### Déclaration de l'ISED Canada:

Cet appareil contient des tasmittre (s) / récepteur (s) sans licence / conformes à l'innovationRSS exemptes de licence de Sciences et Développement économique Canada.

L'opération est sous réserve des deux conditions suivantes :

3. cet appareil ne peut pas causer d'interférences et
4. ce dispositif doit accepter toute interférence, y compris peut provoquer le fonctionnement indésirable de l'appareil.

**Exposition aux rayonnements :** Cet équipement est conforme aux radiations du Canada limites d'exposition pour un environnement incontrôlé noncé d'exposition RF Pour maintenir le respect des guides d'exposition RF d'IC, cquipment doit être installé et actionné avec une distance minimale de 20cm le radiateur de votre corps. Cet appareil et ses antennes ne doivent pas être co-localisé ou en opération en conjonction avec toute autre antenne ou émetteur.

#### **FCC Warning Statement:**

Changes or modifications not expressly approved by the party responsible for compliance could void the user's authority to operate the equipment. This equipment has been tested and found to comply with the limits for a Class B digital device, pursuant to Part 15 of the FCC Rules. These

limits are designed to provide reasonable protection against harmful interference in a residential installation. This equipment generates uses and can radiate radio frequency energy and, if not installed and used in accordance with the instructions, may cause harmful interference to radio communications. However, there is no guarantee that interference will not occur in a particular installation. If this equipment does cause harmful interference to radio or television reception, which can be determined by turning the equipment off and on, the user is encouraged to try to correct the interference by one or more of the following measures:

- Reorient or relocate the receiving antenna.
- Increase the separation between the equipment and receiver.
- Connect the equipment into an outlet on a circuit different from that to which the receiver is connected.
- Consult the dealer or an experienced radio/TV technician for help.

This device complies with part 15 of the FCC Rules. Operation is subject to the following

two conditions: (1) This device may not cause harmful interference, and

(2) this device must accept any interference received, including interference that may cause undesired operation.

#### **RF Exposure Statement**

To maintain compliance with FCC's RF Exposure guidelines, This

equipment should be installed and operated with minimum distance of 20cm the radiator your body.



# REDTIGER

Truly Peace of Mind™

Check us out here.  
Product and service are the foundation of Redtiger.

Instagram: @redtiger\_dashcam  
Facebook: Redtiger Dash Cam



[www.redtigercam.com](http://www.redtigercam.com)