

# DS-1N-2W-40/60

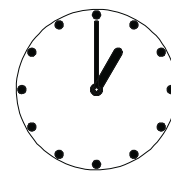

30 min

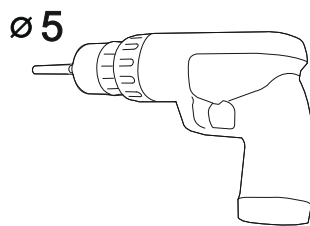

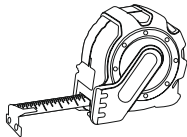
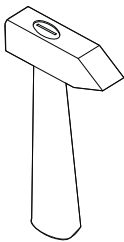
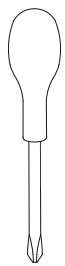
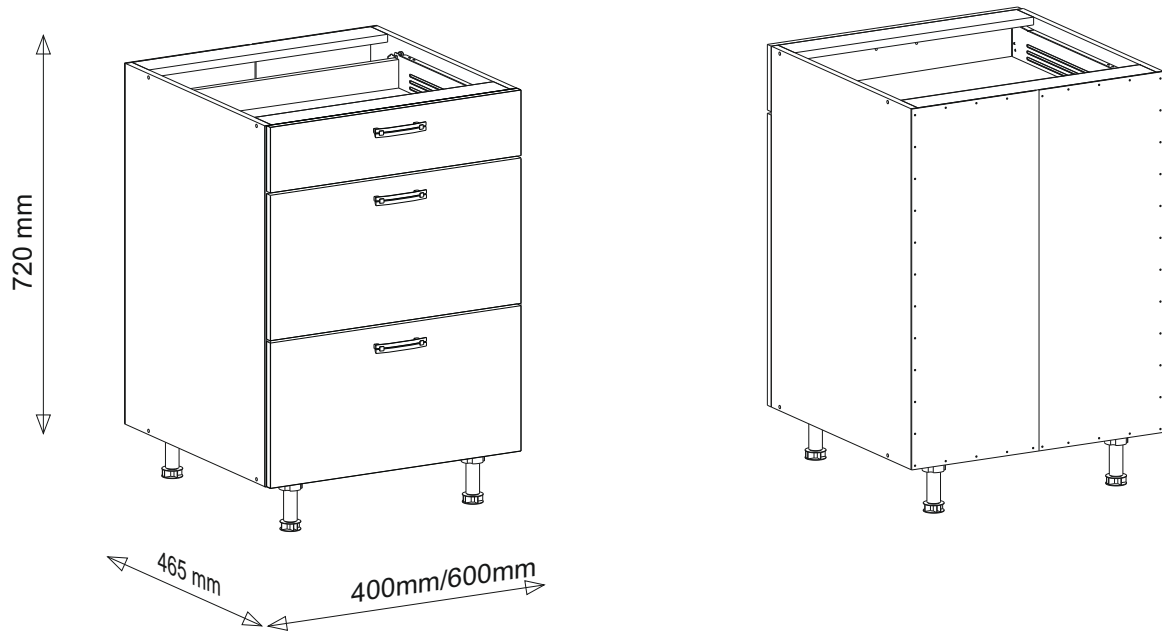
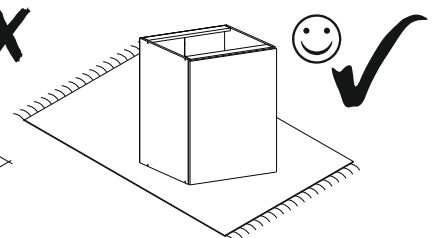
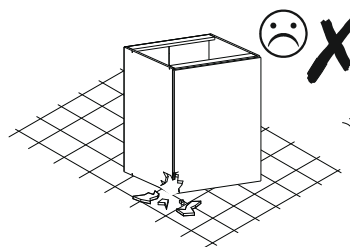
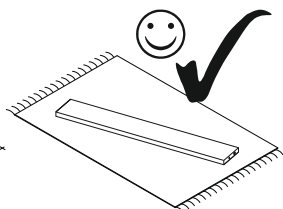
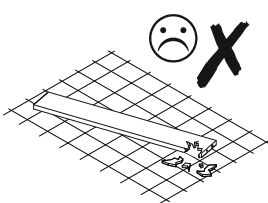
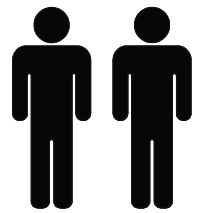
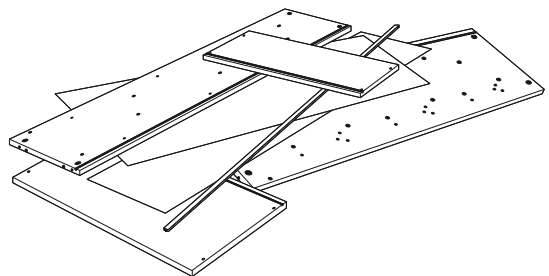
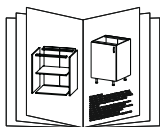
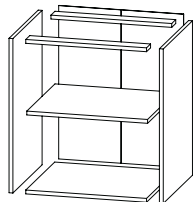
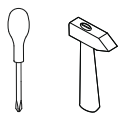
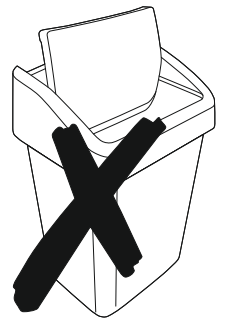
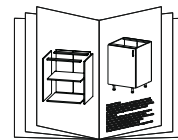
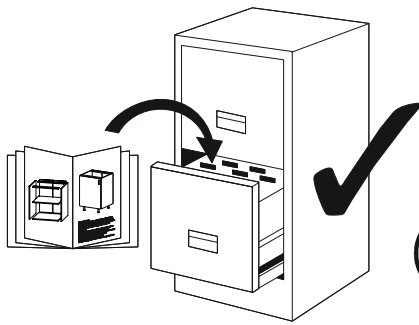
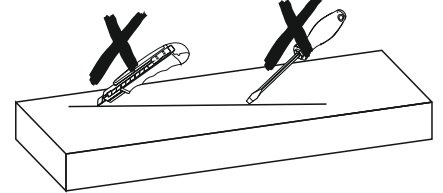
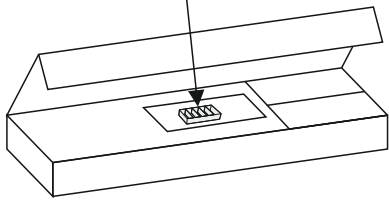
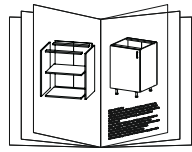

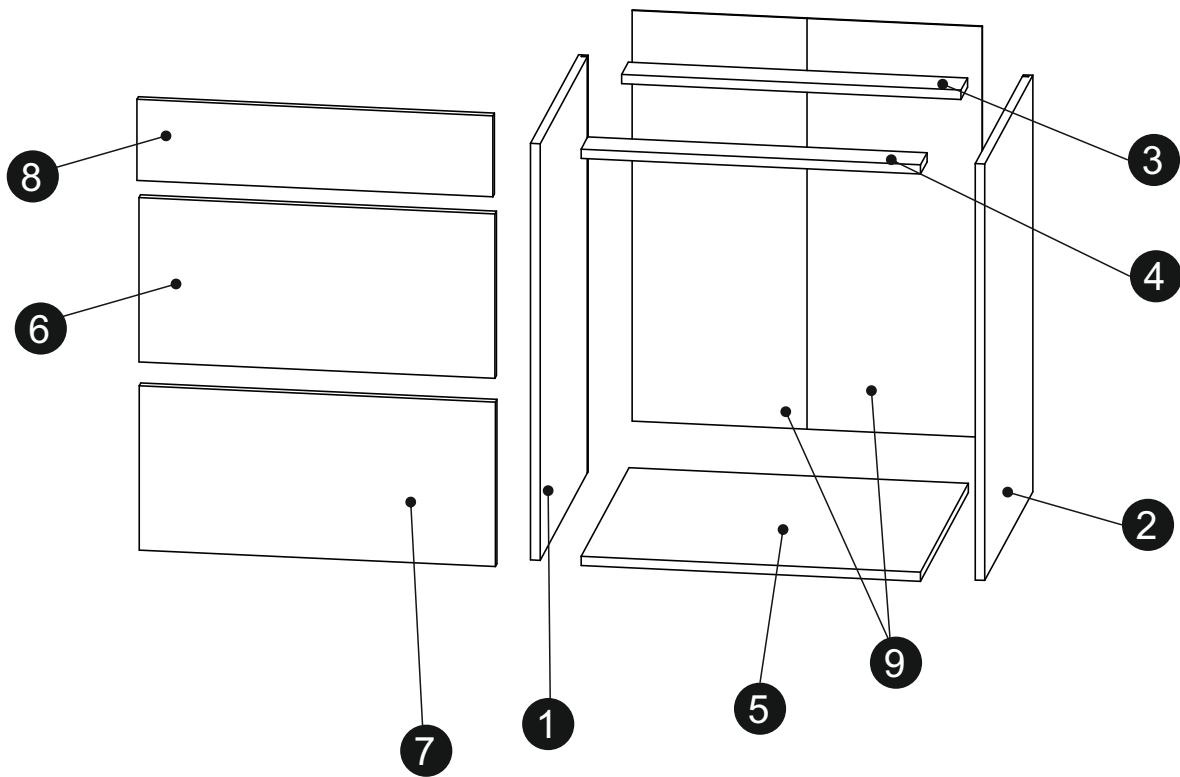

## DS-1N-2W-40

	DLUGOŚĆ LENGTH LÄNGE LONGUEUR	SZEROKOŚĆ WIDTH BREITE LARGEUR	GRUBOŚĆ THICKNESS STÄRKE GROSSEUR	ILOŚĆ QUANTITY ANZAHL QUANTITÉ	KOD CODE CODE CODE	PACZKA BOX SCHACHTEL BOITE
1	720	465	16	1		
2	720	465	16	1		
3	367	70	16	1		
4	367	70	16	1		
5	367	464	16	1		
6	284	396	16	1		
7	284	396	16	1		
8	140	396	16	1		
9	717	397	3	1		

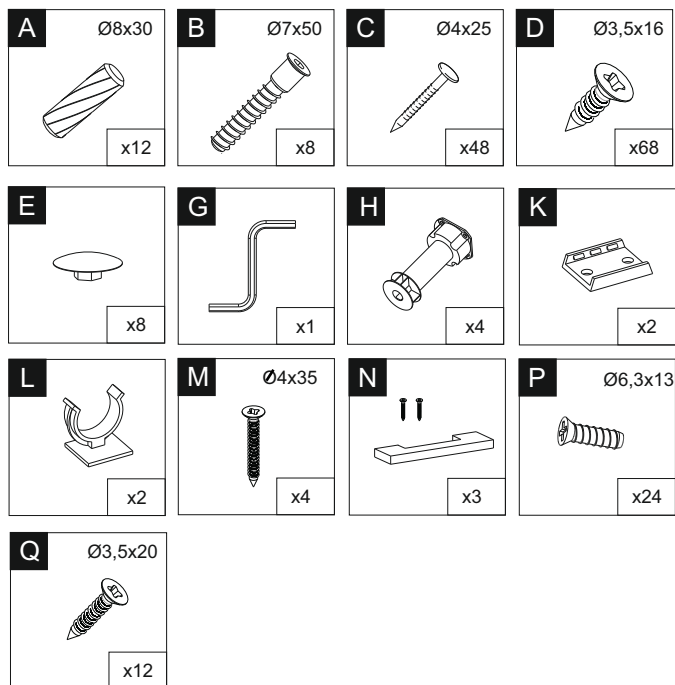

## DS-1N-2W-60

	DLUGOŚĆ LENGTH LÄNGE LONGUEUR	SZEROKOŚĆ WIDTH BREITE LARGEUR	GRUBOŚĆ THICKNESS STÄRKE GROSSEUR	ILOŚĆ QUANTITY ANZAHL QUANTITÉ	KOD CODE CODE CODE	PACZKA BOX SCHACHTEL BOITE
1	720	465	16	1		
2	720	465	16	1		
3	567	70	16	1		
4	567	70	16	1		
5	567	464	16	1		
6	284	596	16	1		
7	284	596	16	1		
8	140	596	16	1		
9	717	598	3	1		

