

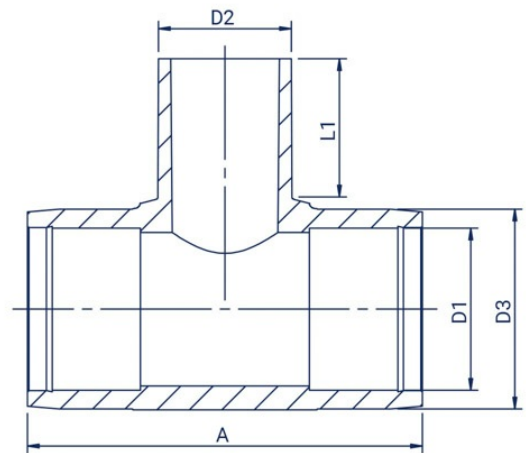

- material: PE 100-RC
- application: water and gas
- 16 bar water, 10 bar gas
- MRS - 10 MPa
- centre stop



D1 (mm)	D2 (mm)	Code	D3 (mm)	A (mm)	L1 (mm)	SDR	Net Weight (kg)	Packing
63	40	TE06304011	82	156	59	11	0.33	25

