

**+48 734 481 529** [filip@kosbel.pl](mailto:filip@kosbel.pl)

Infolinia czynna: pon. - pt. 8:00 - 14:00

**+48 608 567 678** [ewa@kosbel.pl](mailto:ewa@kosbel.pl)

Infolinia czynna: pon. - pt. 12:00 - 18:00



# Velvet



**Fronty** wykonane z solidnej płyty meblowej o grubości **18 mm**.



**Nóżki regulowane** (10 cm) umożliwiają precyzyjne ustawienie szafki nawet na nierównym podłożu.

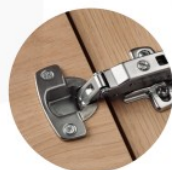

**Zawiasy HETTICH**  
Solidne i wytrzymałe zawiasy wyposażone w ciche domykanie.

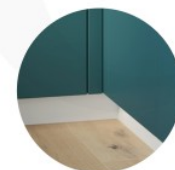

**Cokół (10 cm)** docięty do szerokości szafki dołączony jest do każdej paczki.



**Korpusy** wykonane z płyty meblowej o grubości **18 mm**.

- **Krawędzie frontów** oklejone są obrzeżem ABS o grubości 2 mm. Strona **wewnętrzna frontów ma kolor biały (nie dotyczy koloru DUST GREY)**.
- **Dostępna opcja LONG**, czyli możliwość wykonania dłuższego od korpusu frontu a dolna „wystająca” część tworzy uchwyt (o cenę pytaj handlowca)

# DOSTĘPNE KOLORY KORPUSÓW



Korpusy wykonane są z płyty meblowej, laminowanej o grubości **18 mm**.



Wysokiej jakości zawias Hettich z cichym domykaniem\* w standardzie.



CZARNY



LAVA



GREY



BIAŁY



DĄB ARTISAN

Wysokość szafek wiszących  
**360 / 720 / 960 mm**

Głębokość\* szafek wiszących  
**325 mm**

Wysokość szafek stojących  
z nóżkami i cokołem  
**820 / 154 / 2070 mm**

Głębokość\* szafek stojących  
**500 mm**

Głębokość\* słupków wysokich  
**565 mm**

# SZAFKI WISZĄCE / 72 CM



Solidne i wytrzymałe, zawiasy **HETTICH** z cichym zamykaniem.



Zawieszki regulowane, umożliwiają łatwe i precyzyjne zawieszenie szafek.



Zalecamy stosowanie listw montażowych.

(szer./wys./gł.)

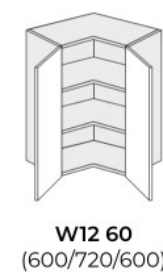
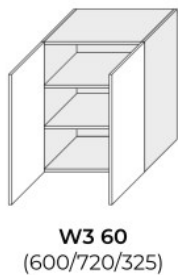
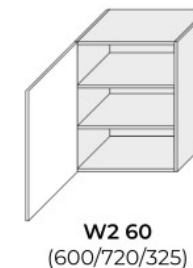
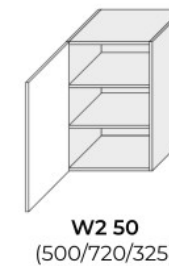
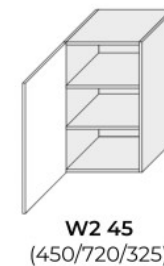
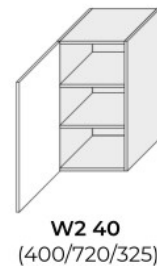
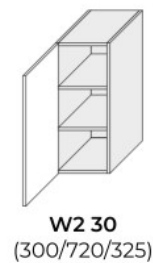
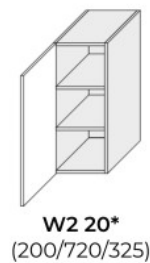
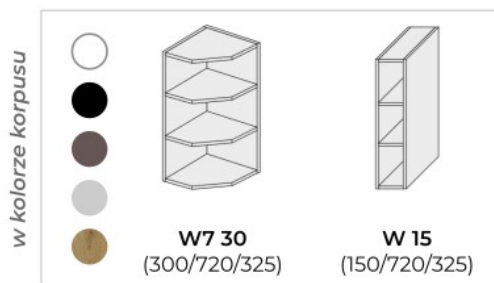

\*szafka **niedostępna** w korpusie LAVA

**NOWOŚĆ! Fronty long**, czyli możliwość wykonania dłuższego od korpusu frontu a dolna „wystająca” część tworzy uchwyt (o cenę pytaj handlowca)



# SZAFKI WISZĄCE / 36 CM

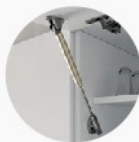

Zastosowanie **teleskopów gazowych** w szafkach otwieranych do góry.



**Zawieszki regulowane**, umożliwiają łatwe i precyzyjne zawieszenie szafek.

(szer./wys./gł.)



**W4B 30**  
(300/360/325)



**W4B 40\***  
(400/360/325)



**W4B 45\***  
(450/360/325)

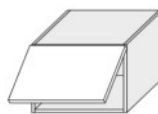

**W4B 50**  
(500/360/325)

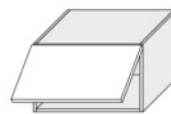

**W4B 60**  
(600/360/325)

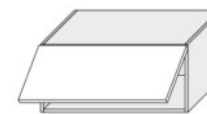

**W4B 80**  
(800/360/325)



**W4B 90**  
(900/360/325)



**W4BS 60 LAM\***  
(600/360/325)



**W4BS 80 LAM\***  
(800/360/325)

LAM - szyba w ramce z płyty meblowej, ramka w kolorze frontu

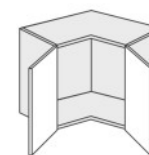

**W12/60**  
(600/360/600)

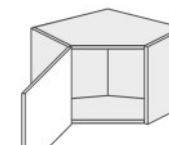

**W10/60**  
(600/360/600)

## NADSTAWKI



**W6B 40**  
(400/360/565)  
nadstawka



**W6B 45\***  
(450/360/565)  
nadstawka



**W6B 50\***  
(500/360/565)  
nadstawka

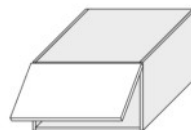

**W6B 60**  
(600/360/565)  
nadstawka



**W6B 80**  
(800/360/565)  
nadstawka

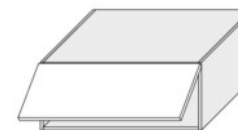

**W6B 90**  
(900/360/565)  
nadstawka



**W14 90**  
(900/360/900)  
nadstawka narożna

\*szafka **niedostępna** w korpusie LAVA

**NOWOŚĆ! Fronty long**, czyli możliwość wykonania dłuższego od korpusu frontu a dolna „wystająca” część tworzy uchwyt (o cenę pytaj handlowca)

# SZAFKI WISZĄCE / 96 CM



Solidne i wytrzymałe, zawiasy **HETTICH** z cichym zamykaniem.



Zawieszki regulowane, umożliwiają łatwe i precyzyjne zawieszenie szafek.



Zalecamy stosowanie listw montażowych.

(szer./wys./gł.)



**W4 20\***  
(200/960/325)

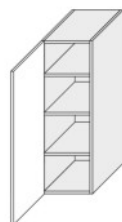

**W4 30**  
(300/960/325)

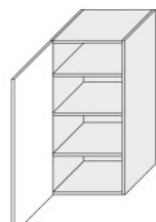

**W4 40**  
(400/960/325)

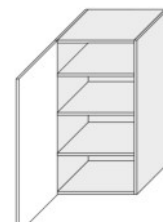

**W4 45**  
(450/960/325)

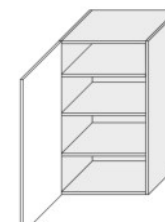

**W4 50**  
(500/960/325)

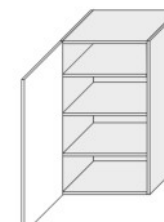

**W4 60**  
(600/960/325)

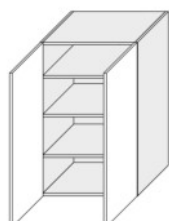

**W4 60 2F**  
(600/960/325)

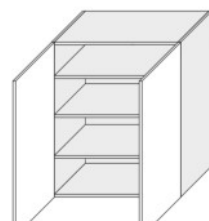

**W4 80**  
(800/960/325)

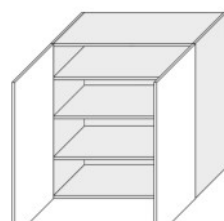

**W4 90**  
(900/960/325)

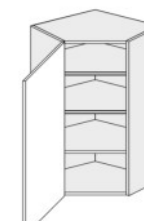

**W4 10/60**  
(600/960/600)

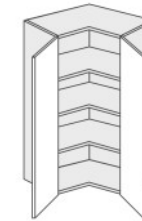

**W14 60/96**  
(600/960/600)

\*szafka **niedostępna** w korpusie LAVA

**NOWOŚĆ!** Fronty long, czyli możliwość wykonania dłuższego od korpusu frontu a dolna „wystająca” część tworzy uchwyt (o cenę pytaj handlowca)



System **AVENTOS** oraz **AVENTOS HK** firmy **BLUM**.  
Komfort ruchu oraz swoboda  
użytkowania każdego dnia.

(szer./wys./gł.)

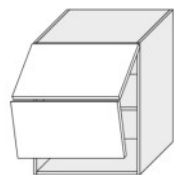

**W8B 60 AVENTOS**  
(600/720/325)

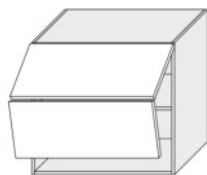

**W8B 80 AVENTOS**  
(800/720/325)

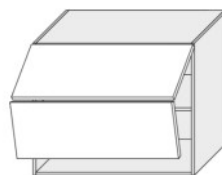

**W8B 90 AVENTOS**  
(900/720/325)



**W4B 60 AVENTOS HK**  
(600/360/325)



**W4B 80 AVENTOS HK**  
(800/360/325)



**W4B 90 AVENTOS HK**  
(900/360/325)



**W8BS 60 AV WKF\***  
(600/720/325)



**W8BS 80 AV WKF\***  
(800/720/325)



**W8BS 90 AV WKF\***  
(900/720/325)

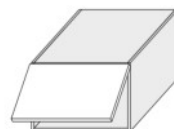

**W6B 40 AV HK**  
(400/360/565)  
nadstawka

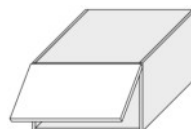

**W6B 45 AV HK\***  
(450/360/565)  
nadstawka



**W6B 50 AV HK\***  
(500/360/565)  
nadstawka



**W6B 80 AV HK**  
(800/360/565)  
nadstawka



**W6B 90 AV HK**  
(900/360/565)  
nadstawka

\*szafka **niedostępna** w korpusie LAVA

**NOWOŚĆ!** Fronty long, czyli możliwość wykonania dłuższego od korpusu frontu a dolna „wystająca” część tworzy uchwyt (o cenę pytaj handlowca)

## SZAFKA PRZYGOTOWANA POD OKAP

## SZAFKA POD MIKROFAŁĘ

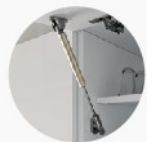

Zastosowanie **teleskopów gazowych** w szafkach otwieranych do góry.

(szer./wys./gł.)



zdjęcie przykładowe

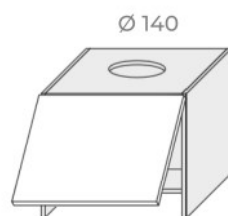

**W8 60**  
(600/500/325)



zdjęcie przykładowe

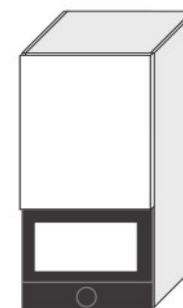

**W4MK 60/96**  
(600/960/325)

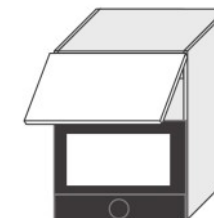

**W2MK/60**  
(600/720/325)



Szafka **PREMIUM** w korpusie **CZARNA PERŁA** z szybą przezroczystą w czarnej ramce aluminiowej.

\*brak opcji cichego domykania w standardzie.



zdjęcie przykładowe

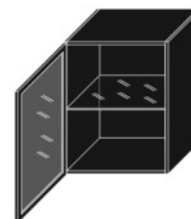

**W3S 60 BLACK ALU\***  
(600/720/325)





# SZAFKI STOJĄCE



Solidne i wytrzymałe, zawiasy HETTICH z cichym zamykaniem.



Nóżki regulowane, umożliwiające precyzyjne ustawienie szafki nawet na nierównym podłożu.

(szer./wys./gt.)

w kolorze korpusu

- 
- 
- 
- 
- 

**D6 30**  
(300/820/500)

**D15 O**  
(150/820/500)

**D1D 20\***  
(200/820/500)

**D1D 30**  
(300/820/500)

**D1D 40**  
(400/820/500)

**D1D 45**  
(450/820/500)

**D1D 50**  
(500/820/500)

**D1D 60**  
(600/820/500)

zabudowa piekarnika

**D11K 60**  
(600/820/500)

pod zlew

**D8Z 80**  
(800/820/500)

**D11 60**  
(600/820/500)

**D11 80**  
(800/820/500)

**D11 90**  
(900/820/500)

**D1D 50 + SEGREGO**  
(500/820/500)

**D1D 60 + SEGREGO**  
(600/820/500)

**D1Z 80 + SEGREGO**  
(800/820/500)



\*szafka niedostępna w korpusie LAVA

## KOSZE CARGO

Przy składaniu zamówienia podaj informację, który typ kosza cargo wybierasz - PURO czy VARIANT.

### SERIA PURO

Kolor czarny + dąb, dostępny w wymiarach 15, 30, 40

**LUB**

### SERIA VARIANT MULTI

\*Kolor srebrny, dostępny w wymiarach 15, 30, 40, 50, 60

(szer./wys./gł.)

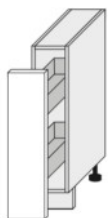

D15 + cargo 15  
(150/820/500)

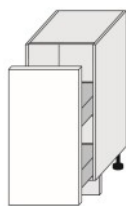

D1D 20 + cargo 20  
(200/820/500)

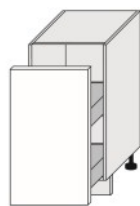

D1D 30 + cargo 30  
(300/820/500)

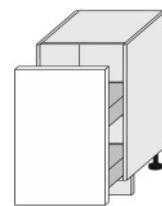

D1D 40 + cargo 40  
(400/820/500)

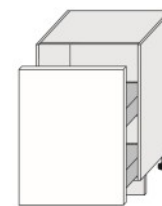

D1D 50 + cargo 50\*  
(500/820/500)

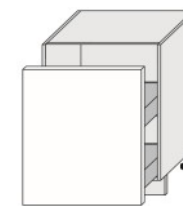

D1D 60 + cargo 60\*  
(600/820/500)

## FRONTY ZMYWARKOWE

Zmywarki do zabudowy wymagają jedynie przedniego panelu. Do ich zabudowy nie jest wymagany dodatkowy korpus.

(szer./wys./gł.)

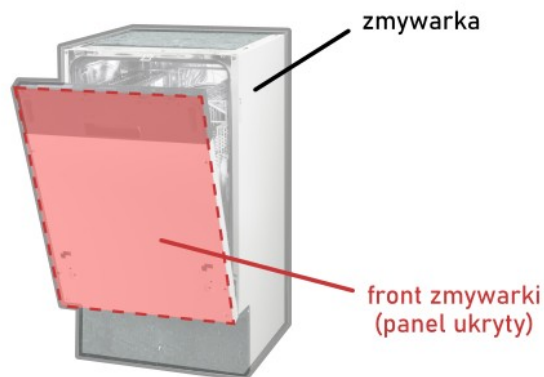

Panel zmywarkowy widoczny



ZM 45/57  
(450/570)



ZM 60/57  
(600/570)

Panel zmywarkowy niewidoczny



ZM 45  
(450/720)



ZM 60  
(600/720)



Wysokiej jakości system szuflad **METABOX / BLUM** zapewniają wysoką stabilność, także w przypadkach **maksymalnego obciążenia, które wynosi 30 kg.** Brak cichego domykania w standardzie\*.

(szer./wys./gł.)

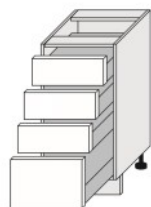

**D4M 40** ●  
(400/820/500)



**D3M 50** ●  
(500/820/500)

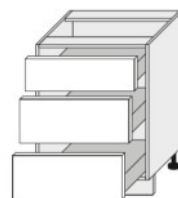

**D3M 60** ●  
(600/820/500)

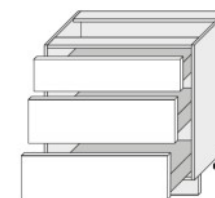

**D3M 80** ●  
(800/820/500)

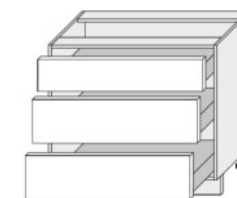

**D3M 90** ●  
(900/820/500)



Szuflady dostępne w kolorze szarym.

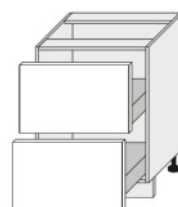

**D2M 60** ●  
(600/820/500)

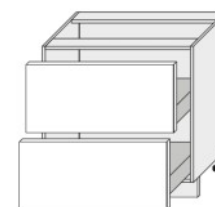

**D2M 80** ●  
(800/820/500)

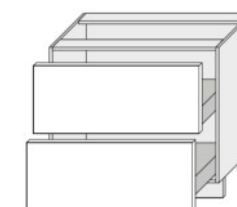

**D2M 90** ●  
(800/820/500)

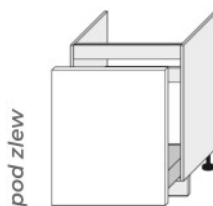

**D1ZM 60** ●  
(600/820/500)

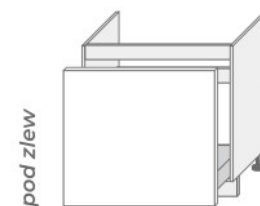

**D1ZM 80** ●  
(800/820/500)

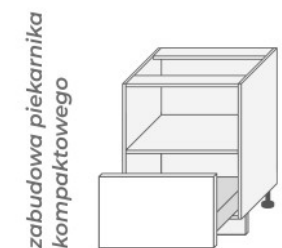

**D11K M/60 KOMPAKT** ●  
(600/820/500)

● - brak cichego domykania\* w standardzie. Opcja dodatkowo płatna.

\*Do szuflady METABOX z częściowym wysuwem można zastosować sprawdzoną funkcję **BLUMOTION** - jest to dodatkowy hamulec do szuflady, który należy dodatkowo zakupić i zamontować.

Szuflady z serii **COMFORT BOX** to innowacyjne produkty umożliwiające utrzymanie porządku na najwyższym poziomie. **Ładowność do 35kg. Pełny wysuw, prowadnica z miękkim dociągiem.**



(szer./wys./gł.)

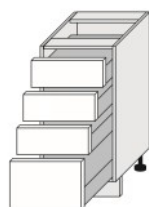

**D4R 40**  
(400/820/500)

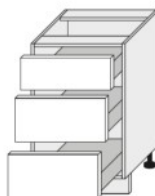

**D3R 50**  
(500/820/500)

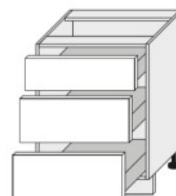

**D3R 60**  
(600/820/500)

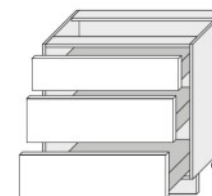

**D3R 80**  
(800/820/500)

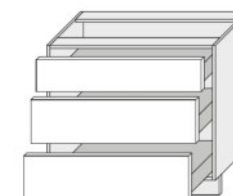

**D3R 90**  
(900/820/500)

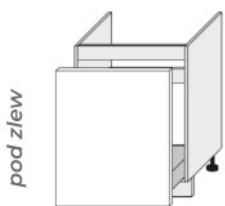

**D1ZR 60**  
(600/820/500)

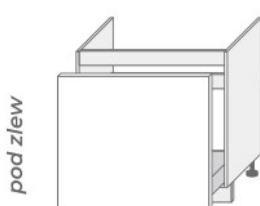

**D1ZR 80**  
(800/820/500)

zabudowa piekarnika  
kompaktowego

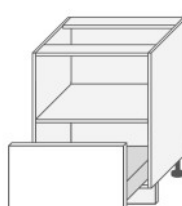

**D11K R/60 KOMPAKT**  
(600/820/500)

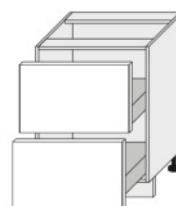

**D2R 60**  
(600/820/500)

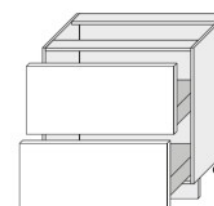

**D2R 80**  
(800/820/500)

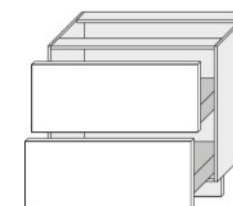

**D2R 90**  
(900/820/500)

PROWADNICE W KOLORZE BIAŁYM.







Wysokiej jakości system szuflad **InnoTech ATIRA** wyposażonych w pełen wysuw oraz **ciche domykanie**. maksymalne obciążenie do **30 kilogramów**.

(szer./wys./gł.)



**D4A 40**  
(400/820/500)

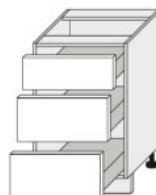

**D3A 50**  
(500/820/500)

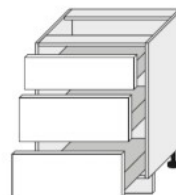

**D3A 60**  
(600/820/500)

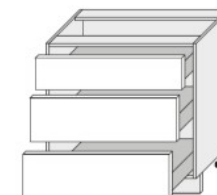

**D3A 80**  
(800/820/500)

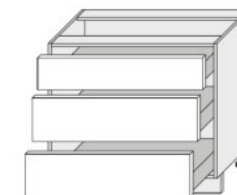

**D3A 90**  
(900/820/500)

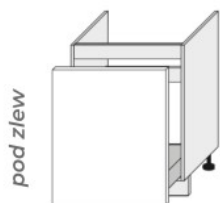

**D1ZA 60**  
(600/820/500)

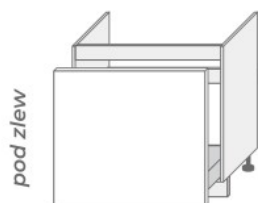

**D1ZA 80**  
(800/820/500)

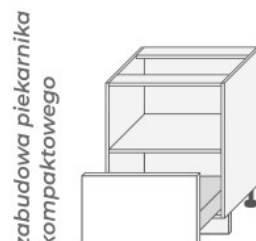

**D11K A/60 KOMPAKT**  
(600/820/500)

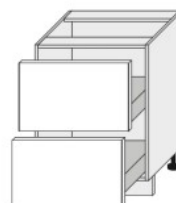

**D2A 60**  
(600/820/500)

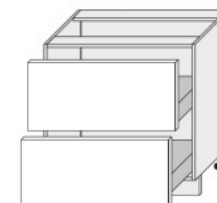

**D2A 80**  
(800/820/500)

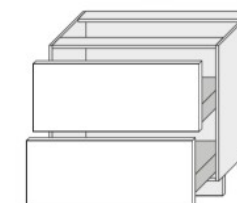

**D2A 90**  
(900/820/500)



**PROWDANICE W KOLORZE ANTRACYT.**

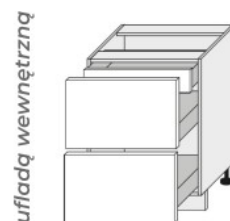

**D2A/60/1A**  
(600/820/500)

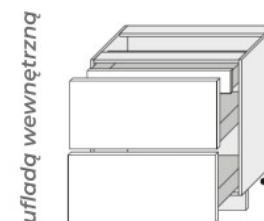

**D2A/80/1A**  
(800/820/500)

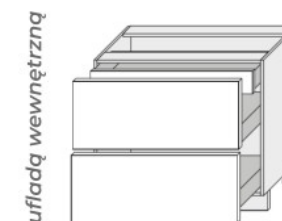

**D2A/90/1A**  
(900/820/500)



# SZAFKI STOJĄCE, NAROŻNE

(szer./wys./gł.)

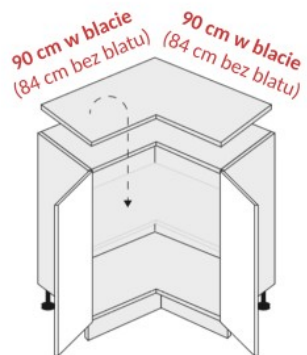

**D12 90 bez półki**  
(840/820/840)

półka dla D12 90



kosz obrotowy

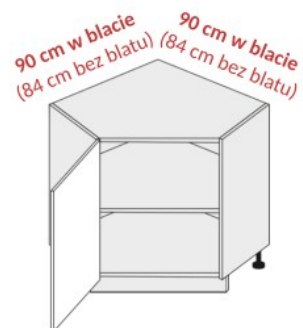

**D12R 90**  
(840/820/840)



**D13U 90 L/P**  
(900/820/500)

## SŁUPKI 154 CM

(szer./wys./gł.)



**D5AM 60 / 154** ●  
(600/1540/565)



**D5AR 60 / 154**  
(600/1540/565)



**D5AA 60 / 154**  
(600/1540/565)

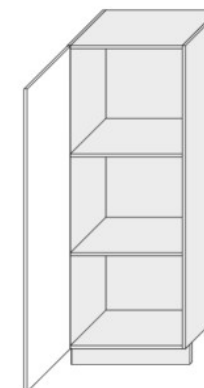

**D5D 60 / 154**  
(600/1540/565)

# SŁUPKI 207 CM

(szer./wys./gł.)

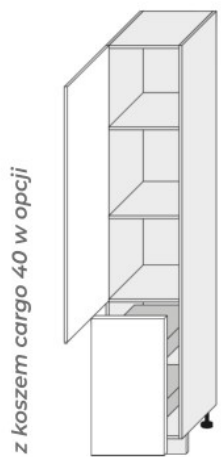

**2D14K 40**  
(400/2070/565)

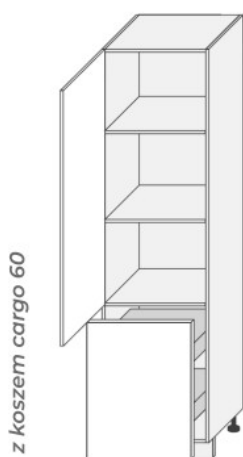

**D14DP 60**  
(600/2070/565)

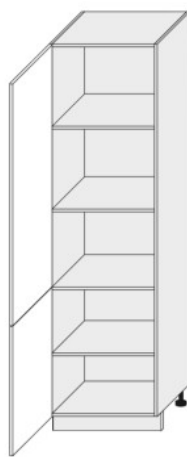

**D14 DP 60**  
(600/2070/565)

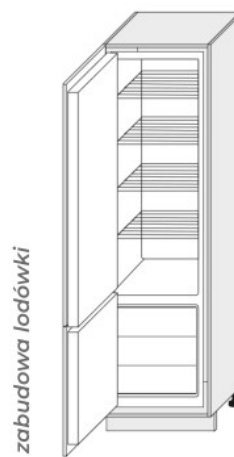

**D14 DL 60**  
(600/2070/565)

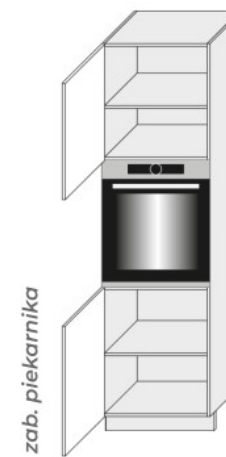

**D14 RU 2D 60**  
(600/2070/565)

**blum**

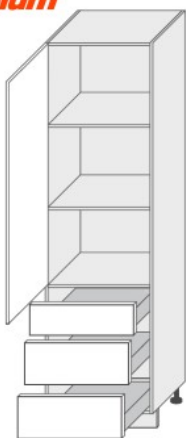

**D/14/DP/3M** ●  
(600/2070/565)

**REJS**

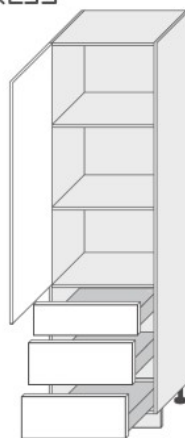

**D/14/DP/3R**  
(600/2070/565)

**Hettich**

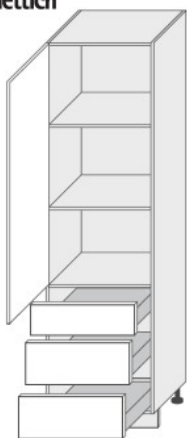

**D/14/DP/3A**  
(600/2070/565)





zab. piekarnika kompakt i mikrofalni

**D14 RU 2M KOMPAKT** ●  
(600/2070/565)

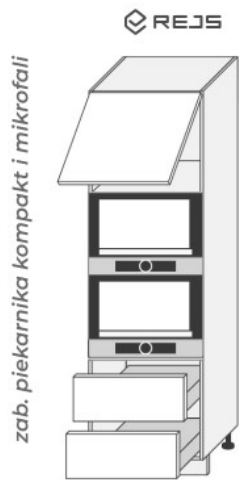

zab. piekarnika kompakt i mikrofalni

**D14 RU 2R KOMPAKT**  
(600/2070/565)

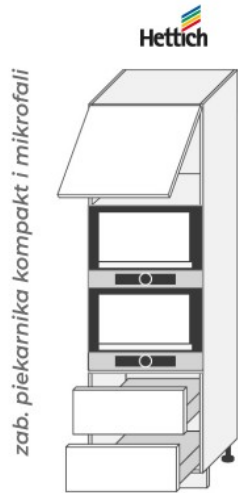

zab. piekarnika kompakt i mikrofalni

**D14 RU 2A KOMPAKT**  
(600/2070/565)

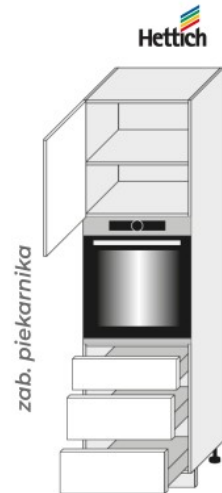

zab. piekarnika

**D14 RU 3A 60**  
(600/2070/565)



zab. piekarnika

**D14 RU 2A 60 356**  
(600/2070/565)



zab. piekarnika i mikrofalni

**D14 RU 2A 60 284**  
(600/2070/565)

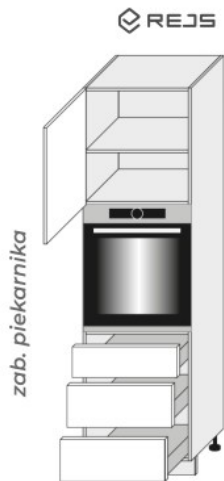

zab. piekarnika

**D14 RU 3R 60**  
(600/2070/565)



zab. piekarnika

**D14 RU 2R 60 356**  
(600/2070/565)



zab. piekarnika i mikrofalni

**D14 RU 2R 60 284**  
(600/2070/565)

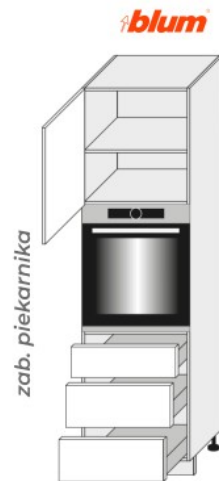

zab. piekarnika

**D14 RU 3M 60** ●  
(600/2070/565)

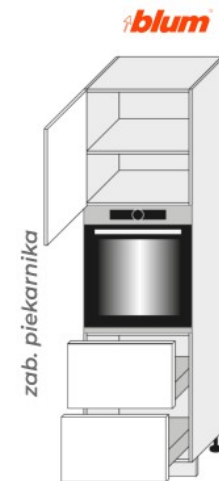

zab. piekarnika

**D14 RU 2M 60 356** ●  
(600/2070/565)

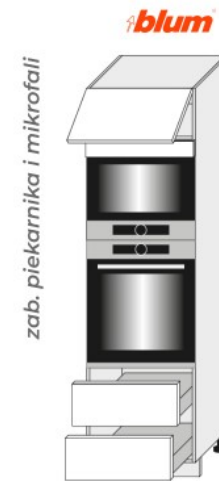

zab. piekarnika i mikrofalni

**D14 RU 2M 60 284** ●  
(600/2070/565)

● - brak cichego domykania szuflad w standardzie

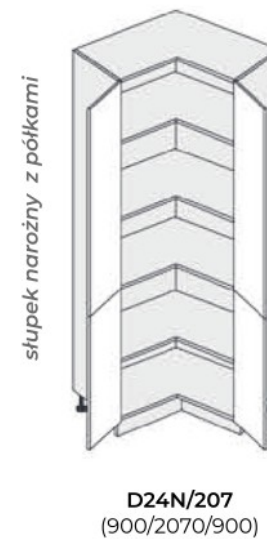
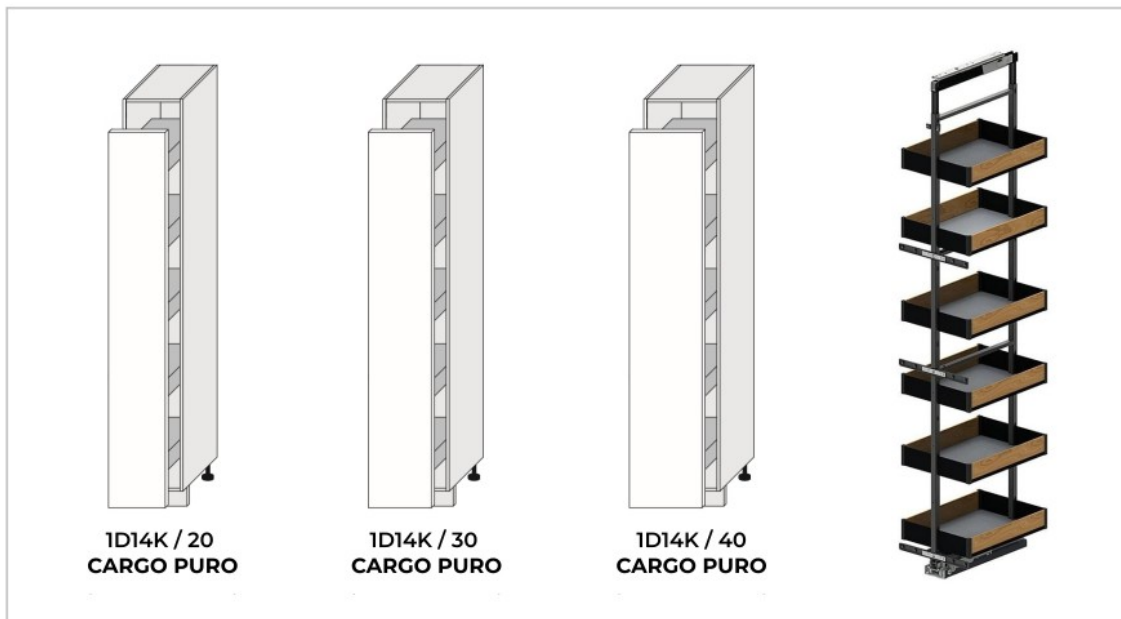

Meble Kosbel

[www.kosbel.pl](http://www.kosbel.pl)



[kosbel.pl](https://www.instagram.com/kosbel.pl)

# WYMIARY AGD DO NASZYCH SZAFEK

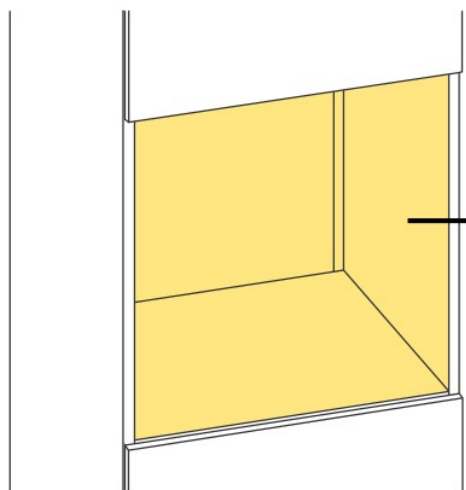

PIEKARNIK  
max.  
**564/590/565**  
(szer./wys./gł.)

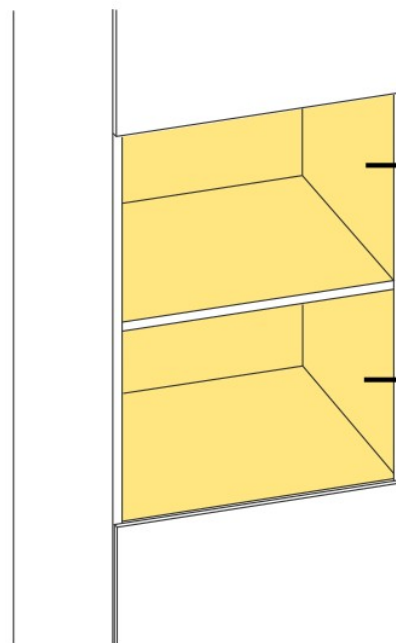

SŁUPEK KOMPAKT  
max.  
**564/450/565**  
(szer./wys./gł.)

max.  
**564/450/565**  
(szer./wys./gł.)

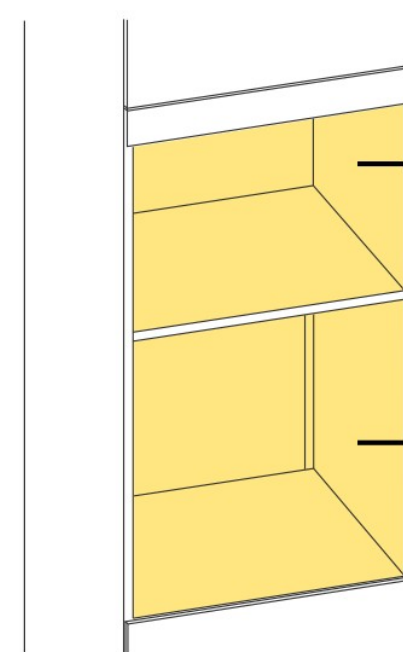

MIKROFALA  
max.  
**564/458/565**  
(szer./wys./gł.)

PIEKARNIK  
max.  
**564/590/565**  
(szer./wys./gł.)

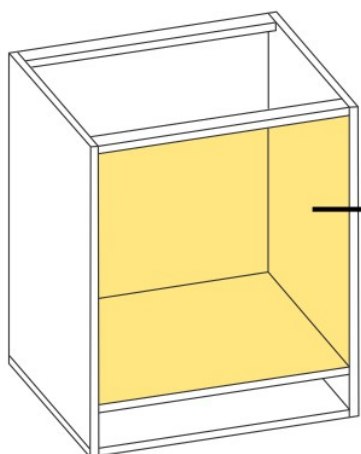

D11K 60  
max.  
**564/600/500**  
(szer./wys./gł.)

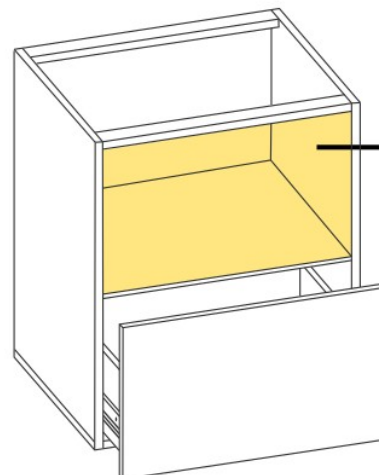

D11K KOMPAKT  
max.  
**564/450/500**  
(szer./wys./gł.)

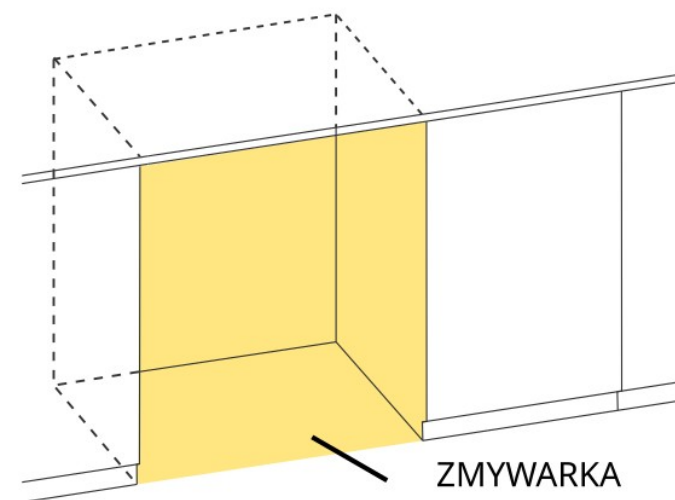

ZMYWARKA  
max. **450/820/550**  
max. **600/820/550**  
(szer./wys./gł.)



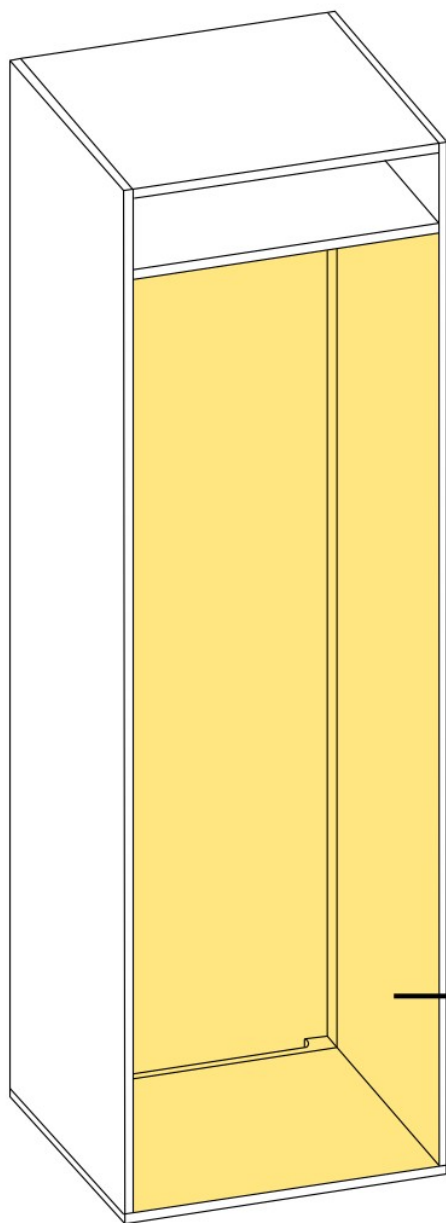

LODÓWKA  
**max.**  
**1780/564/565**  
*(szer./wys./gł.)*

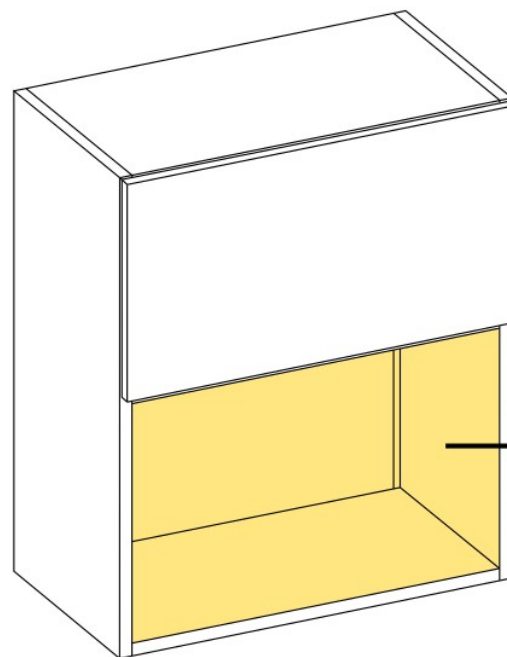

MIKROFALA  
**max.**  
**564/360/305-325\***  
*(szer./wys./gł.)*

OKAP  
**max.**  
**564/329/305**  
*(szer./wys./gł.)*

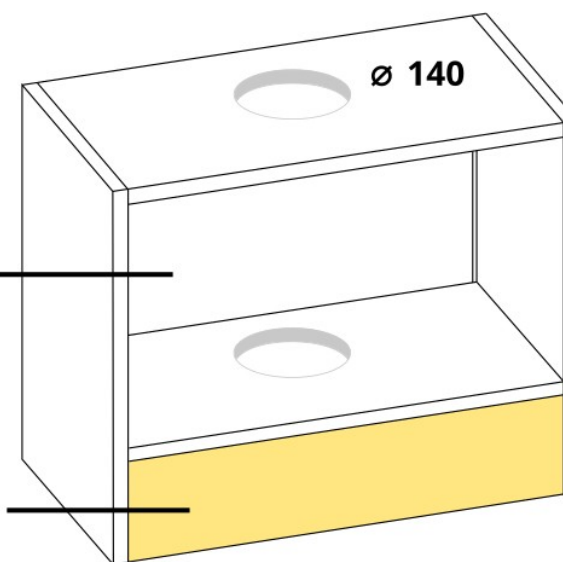

**max.**  
**564/135/305**  
*(szer./wys./gł.)*

Ø 140

## W NASZEJ OFERCIE ZNAJDZIESZ RÓWNIEŻ



blaty laminowane na wymiar  
według potrzeb klienta



uchwyty standardowe, gałki,  
uchwyty krawędziowe



pojemniki na odpady,  
szuflady z pojemnikami  
na odpady



oświetlenie podszawkowe,  
szafkowe oraz cokołów



możliwość zakupu  
pojedynczych frontów  
lub korpusów



kosze cargo, nóżki cokołowe,  
listwy, spawalnicze, stelaże  
metalowe i wiele więcej...

O SZCZEGÓŁY PYTAJ HANDLOWCÓW

[ewa@kosbel.pl](mailto:ewa@kosbel.pl)

[filip@kosbel.pl](mailto:filip@kosbel.pl)

Katalog nie stanowi oferty w rozumieniu prawa i jest publikowany jedynie dla celów informacyjnych. Prowadząc politykę ciągłego rozwoju zastrzegamy sobie prawo do zmian i ulepszeń produktów przedstawionych w katalogu bez uprzedniego powiadomienia. Kolorystyka przedstawiona w katalogu może się różnić od rzeczywistej. Zastrzegamy sobie prawo do błędów w druku.