

VEVOR[®]

TOUGH TOOLS, HALF PRICE

Technical Support and E-Warranty Certificate

www.vevor.com/support

DRYWALL STILTS USER MANUAL

We continue to be committed to provide you tools with competitive price.

"Save Half", "Half Price" or any other similar expressions used by us only represents an estimate of savings you might benefit from buying certain tools with us compared to the major top brands and does not necessarily mean to cover all categories of tools offered by us. You are kindly reminded to verify carefully when you are placing an order with us if you are actually saving half in comparison with the top major brands.

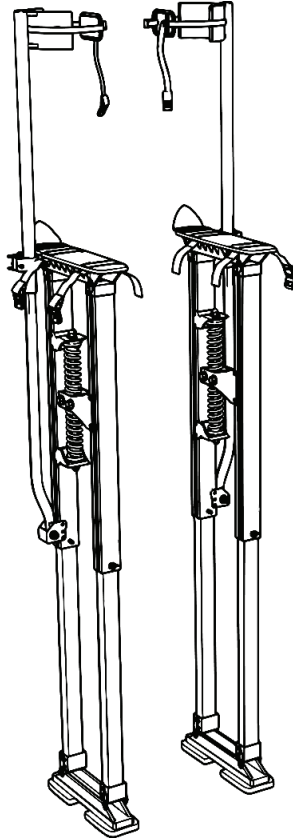

NEED HELP? CONTACT US!

Have product questions? Need technical support? Please feel free to contact us:

Technical Support and E-Warranty Certificate

www.vevor.com/support

This is the original instruction. Please read all manual instructions carefully before operating. VEVOR reserves a clear interpretation of our user manual. The appearance of the product shall be subject to the product you received. Please forgive us that we won't inform you again if there are any technology or software updates on our product.



Safety Instructions

1. Inspect the stilts thoroughly before use. Ensure that the parts are free of damage and that all the bolts and screws are fully tightened enough.
2. Use this product only on level and flat ground surfaces and there is no low profile furniture and other obstructions around.
3. When adjusting the height of the stilts, take them off your legs first for safety concerns.
4. Keep all straps fastened and secured before you walk on the stilts.
5. When walking on the stilts, never take a big step. Instead, make sure the stilts are raised well above the ground with each step.
6. Never use the stilts to walk on a slippery ground.
7. Never overload the stilts.
8. Walk slowly. Don't run or walk fast on the stilts.
9. Don't modify the stilts arbitrarily.
10. Don't walk on the stilts if you are influenced by alcohol or drugs.
11. Children are not allowed to use this product. Minors and seniors are not recommended to use this product.
12. Ensure the surrounding area is clean when using this product. Always wear protective gear (especially for the knee and elbow) and a helmet before using the product. It's recommended that the beginner uses two supporting sticks for balance.
13. It is forbidden to use this product on public roads or streets.
14. When using the product, it is recommended to wear anti-slip shoes.
15. The intended purpose of this product is for architectural decoration or ceiling repair. It is not for entertaining or dancing.
16. It's recommended to let the other 2 people assist the user stand on the stilts.

PACKAGE CONTENT

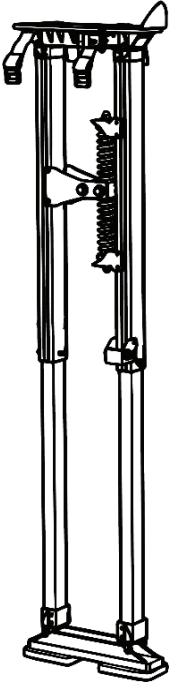

Skid-proof Rubber Sole x 2

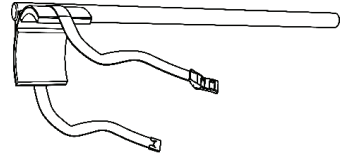

Metal Buckle x 2

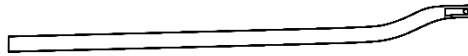

Supporting Stick x 2

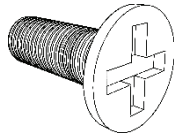

Bolt x 4

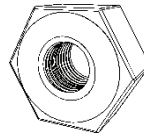

Nut x 4

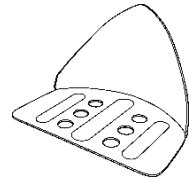

3-Position Heel Bracket x 2

SPECIFICATIONS

Model Series	HCST-18SI	HCST-24SI	HCST-24BK	HCST-36SI
Overall Dimensions (L x W x H)	32.5" x 10.8" x 5.3" (825x275x135mm)	36.2" x 11" x 5.5" (920x280x140mm)	36.2" x 11" x 5.5" (920x280x140mm)	48" x 11" x 5.5" (1220x280x140 mm)
Weight Capacity	228 lbs (103 kg)	228 lbs (103 kg)	228 lbs (103 kg)	228 lbs (103 kg)
Adjustable Height	18" to 30" (457 to 762 mm)	24" to 40" (610 to 1016mm)	24" to 40" (610 to 1016mm)	36" to 50" (914 to 1267mm)

ASSEMBLY INSTRUCTIONS

The assembly procedures of the two stilts are the same. Here we take one stilt as an example. You can follow the same steps to finish the assembly for the other stilt.

1

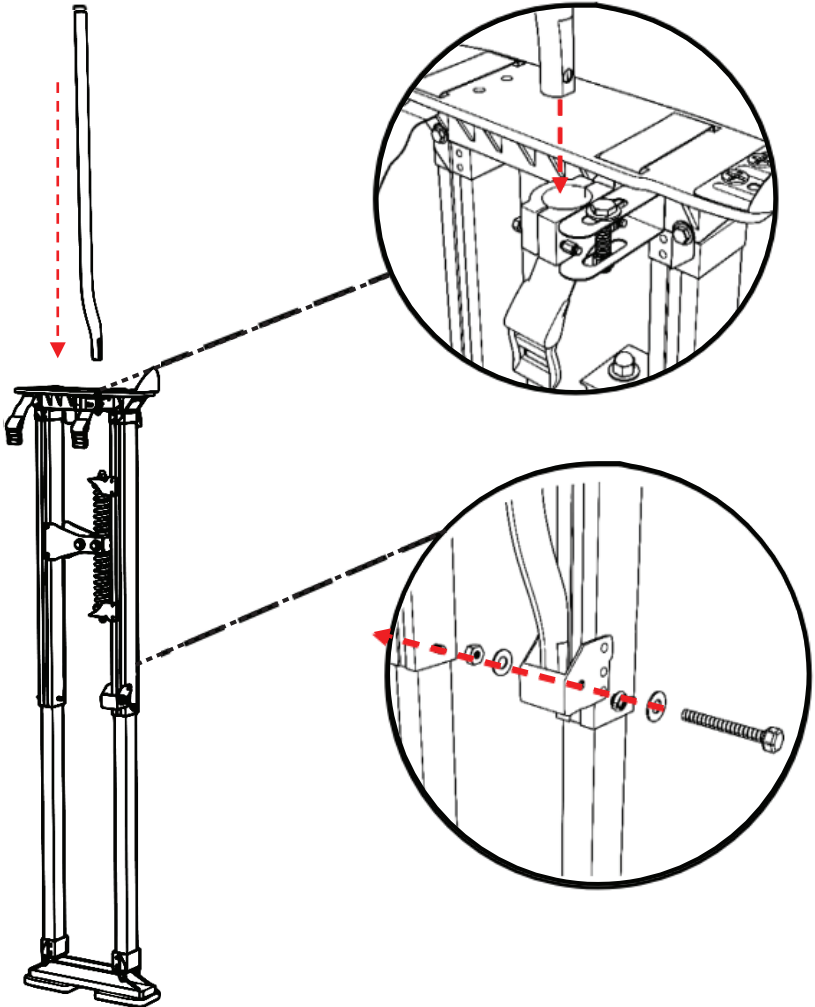

1. Insert the supporting stick through the side hole on the left stilt.
2. Secure the end of the supporting stick on the side bracket of the left stilt with the bolt and nut.
(The bolt and nut are preinstalled on the side bracket.)

2

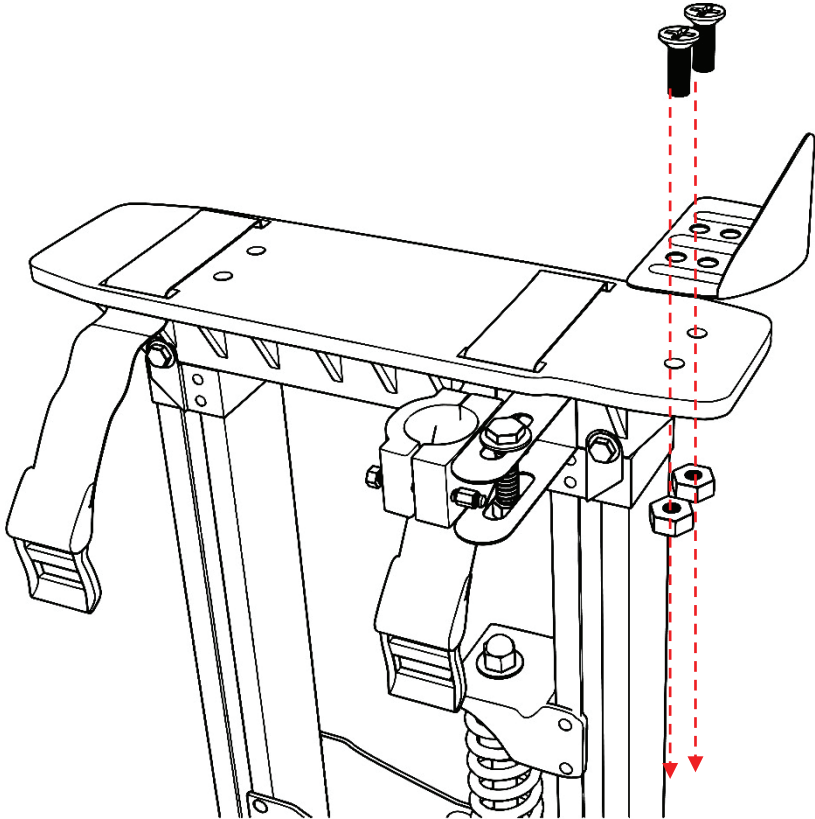

Install the heel bracket on the top of the stilt with two bolts and two nuts. Depending on the size of your feet, choose the front or back holes to install.

3

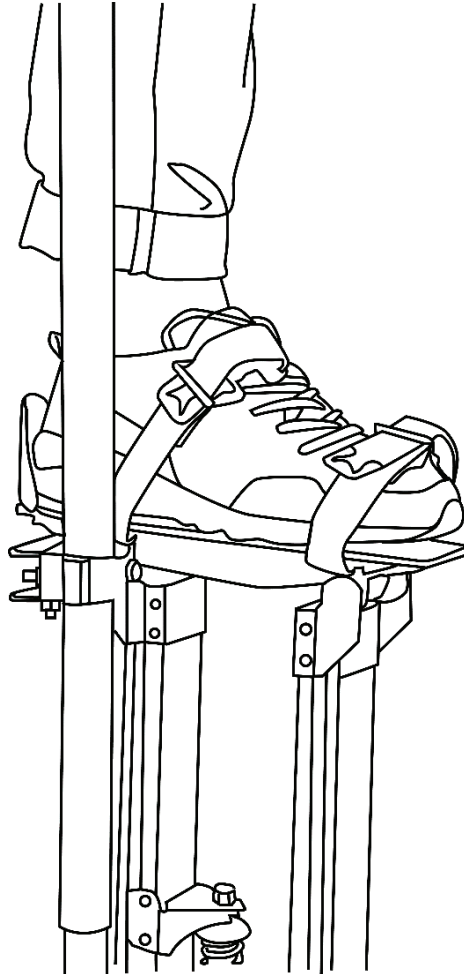

Use the straps on the stilt to secure your feet. Ensure that the straps are fastened tightly.

4

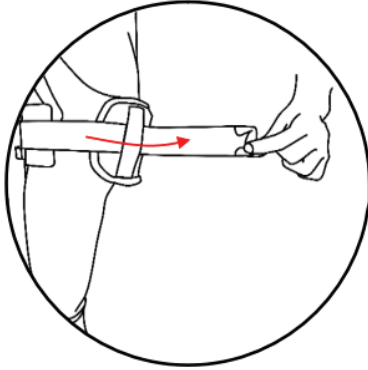

Thread the ends of the strap through the skid-proof rubber sole.



Thread the end of the strap through their buckles.

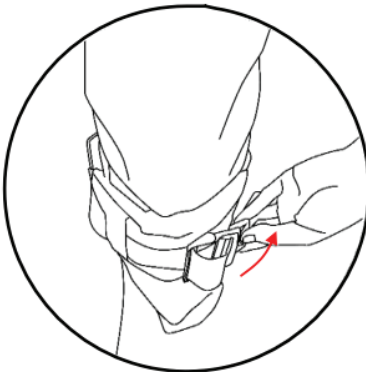
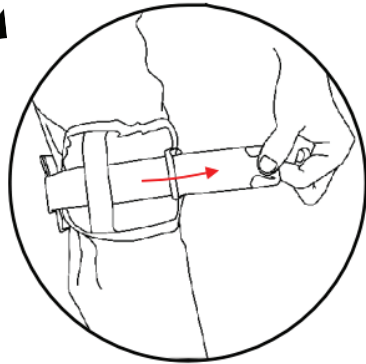

Fasten up the strap.

Ensure that the strap is fastened tightly and then the preparation is finished.

ADJUST THE STILT HEIGHT

NOTE:

Before adjusting the height of the stilts, take your feet off the stilts first.

1

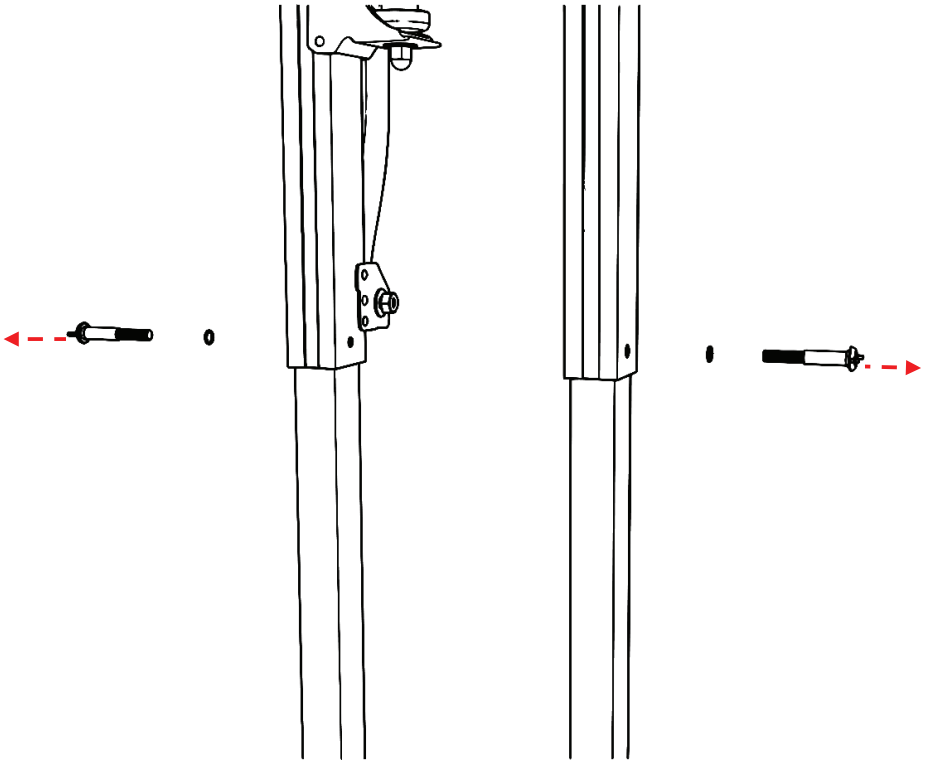

Loosen and separate the 4 bolts on the stilts.

2

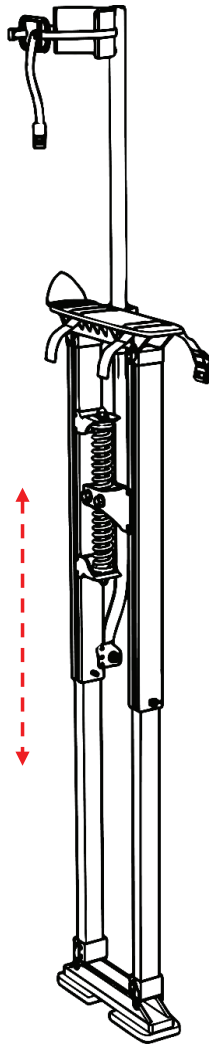

Adjust the height of the stilts. Ensure that the heights of both stilts are the same. After that, fasten the bolts.

Manufacturer: Shanghaimuxinmuyeyouxiangongsi

Address: Shuangchenglu 803nong11hao1602A-1609shi, baoshanqu, shanghai 200000 CN.

Imported to AUS: SIHAO PTY LTD. 1 ROKEVA STREETEASTWOOD NSW 2122 Australia

Imported to USA: Sanven Technology Ltd. Suite 250, 9166 Anaheim Place, Rancho Cucamonga, CA 91730



E-CrossStu GmbH
Mainzer Landstr.69,
60329 Frankfurt am Main.



YH CONSULTING LIMITED. C/O YH Consulting
Limited Office 147, Centurion House, London
Road, Staines-upon-Thames, Surrey, TW18 4AX

VEVOR[®]

TOUGH TOOLS, HALF PRICE

Technical Support and E-Warranty Certificate

www.vevor.com/support

VEVOR[®]

TOUGH TOOLS, HALF PRICE

Technical Support and E-Warranty Certificate

www.vevor.com/support

DRYWALL STILTS USER MANUAL

We continue to be committed to provide you tools with competitive price.

"Save Half", "Half Price" or any other similar expressions used by us only represents an estimate of savings you might benefit from buying certain tools with us compared to the major top brands and does not necessarily mean to cover all categories of tools offered by us. You are kindly reminded to verify carefully when you are placing an order with us if you are actually saving half in comparison with the top major brands.

VEVOR[®]

DRYWALL STILTS USER MANUAL

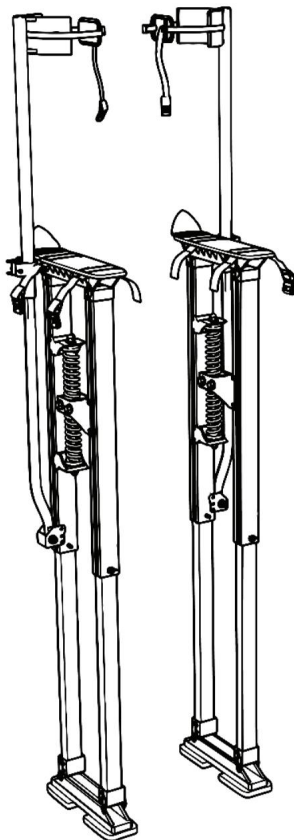

NEED HELP? CONTACT US!

Have product questions? Need technical support? Please feel free to contact us:

Assistance technique et certificat de garantie

électronique www.vevor.com/support

This is the original instruction. Please read all manual instructions carefully before operating. VEVOR reserves a clear interpretation of our user manual. The appearance of the product shall be subject to the product you received. Please forgive us that we won't inform you again if there are any technology or software updates on our product.



Safety Instructions

1. Inspect the stilts thoroughly before use. Ensure that the parts are free of damage and that all the bolts and screws are fully tightened enough.
2. Use this product only on level and flat ground surfaces and there is no low profile furniture and other obstructions around.
3. When adjusting the height of the stilts, take them off your legs first for safety concerns.
4. Keep all straps fastened and secured before you walk on the stilts.
5. When walking on the stilts, never take a big step. Instead, make sure the stilts are raised well above the ground with each step.
6. Never use the stilts to walk on a slippery ground.
7. Never overload the stilts.
8. Walk slowly. Don't run or walk fast on the stilts.
9. Don't modify the stilts arbitrarily.
10. Don't walk on the stilts if you are influenced by alcohol or drugs.
11. Children are not allowed to use this product. Minors and seniors are not recommended to use this product.
12. Ensure the surrounding area is clean when using this product. Always wear protective gear (especially for the knee and elbow) and a helmet before using the product. It's recommended that the beginner uses two supporting sticks for balance.
13. It is forbidden to use this product on public roads or streets.
14. When using the product, it is recommended to wear anti-slip shoes.
15. The intended purpose of this product is for architectural decoration or ceiling repair. It is not for entertaining or dancing.
16. It's recommended to let the other 2 people assist the user stand on the stilts.

PACKAGE CONTENT

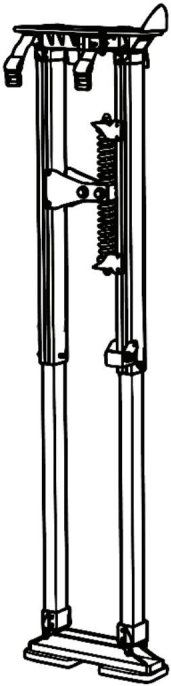

Skid-proof Rubber Sole x 2

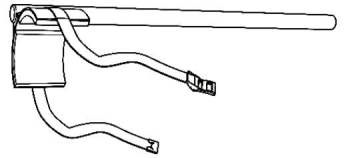

Metal Buckle x 2

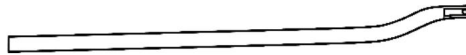

Supporting Stick x 2

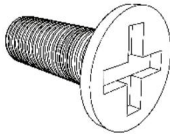

Bolt x 4

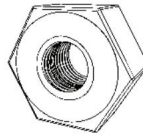

Nut x 4

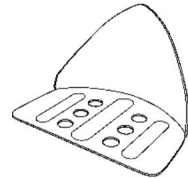

3-Position Heel Bracket x 2

SPECIFICATIONS

Série de modèles	HCST-18SI	HCST-24SI	HCST-24BK	HCST-36SI
Dimensions hors tout (L x l x H)	32,5" x 10,8" x 5,3" (825 x 275 x 135 mm)	36,2" x 11" x 5,5" (920x280x140mm)	36,2" x 11" x 5,5" (920x280x140mm)	48" x 11" x 5,5" (1220x280x140 mm)
Capacité de poids	228 livres (103 kg)	228 livres (103 kg)	228 livres (103 kg)	228 livres (103 kg)
Hauteur réglable	18" à 30" (457 à 762 mm)	24" à 40" (610 à 1016 mm)	24" à 40" (610 à 1016 mm)	36" à 50" (914 à 1267 mm)

ASSEMBLY INSTRUCTIONS

The assembly procedures of the two stilts are the same. Here we take one stilt as an example. You can follow the same steps to finish the assembly for the other stilt.

1

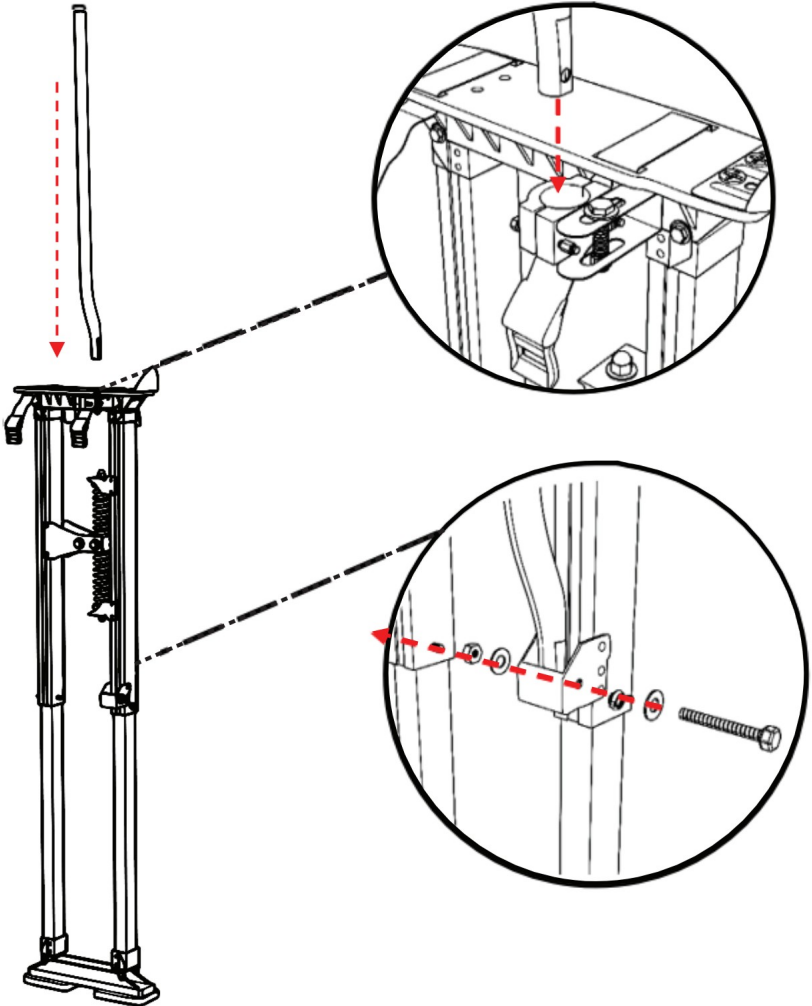

1. Insert the supporting stick through the side hole on the left stilt.
2. Secure the end of the supporting stick on the side bracket of the left stilt with the bolt and nut.
(The bolt and nut are preinstalled on the side bracket.)

2

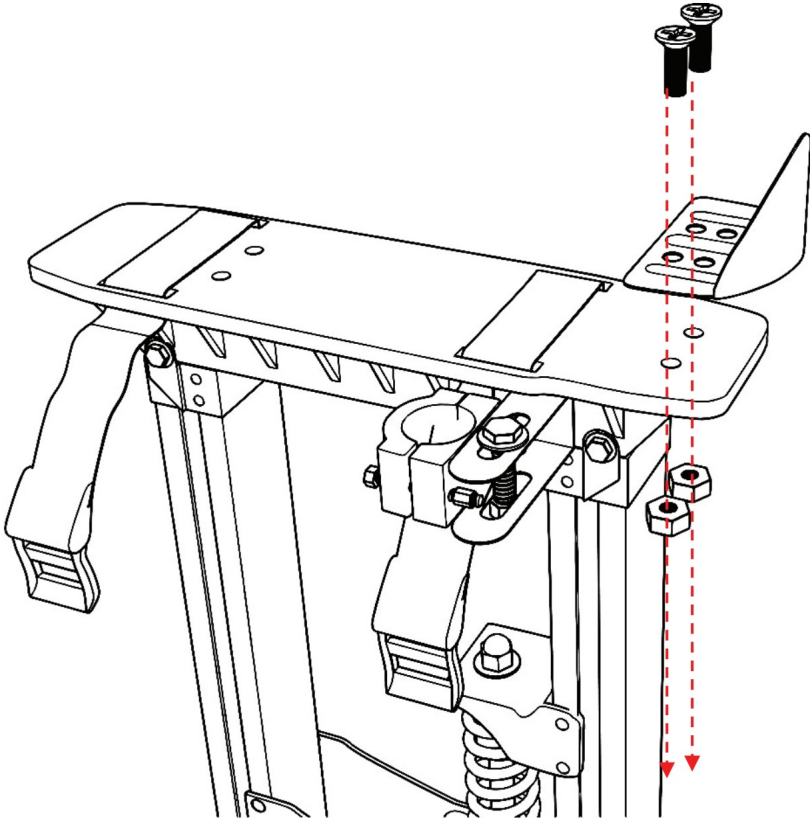

Install the heel bracket on the top of the stilt with two bolts and two nuts. Depending on the size of your feet, choose the front or back holes to install.

3



Use the straps on the stilt to secure your feet. Ensure that the straps are fastened tightly.

4

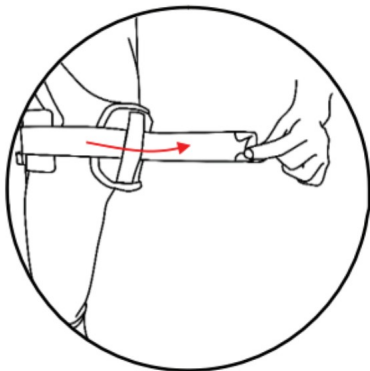

Thread the ends of the strap through the skid-proof rubber sole.

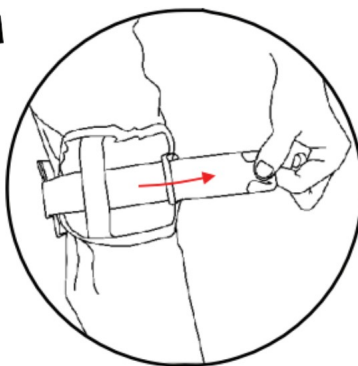

Thread the end of the strap through their buckles.

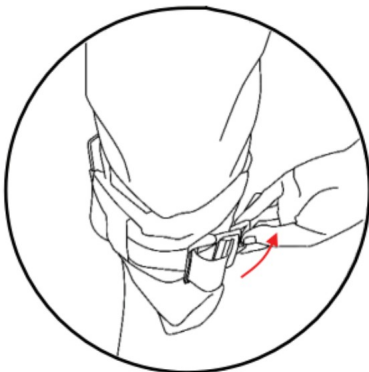

Fasten up the strap.

Ensure that the strap is fastened tightly and then the preparation is finished.

ADJUST THE STILT HEIGHT

NOTE:

Before adjusting the height of the stilts, take your feet off the stilts first.

1

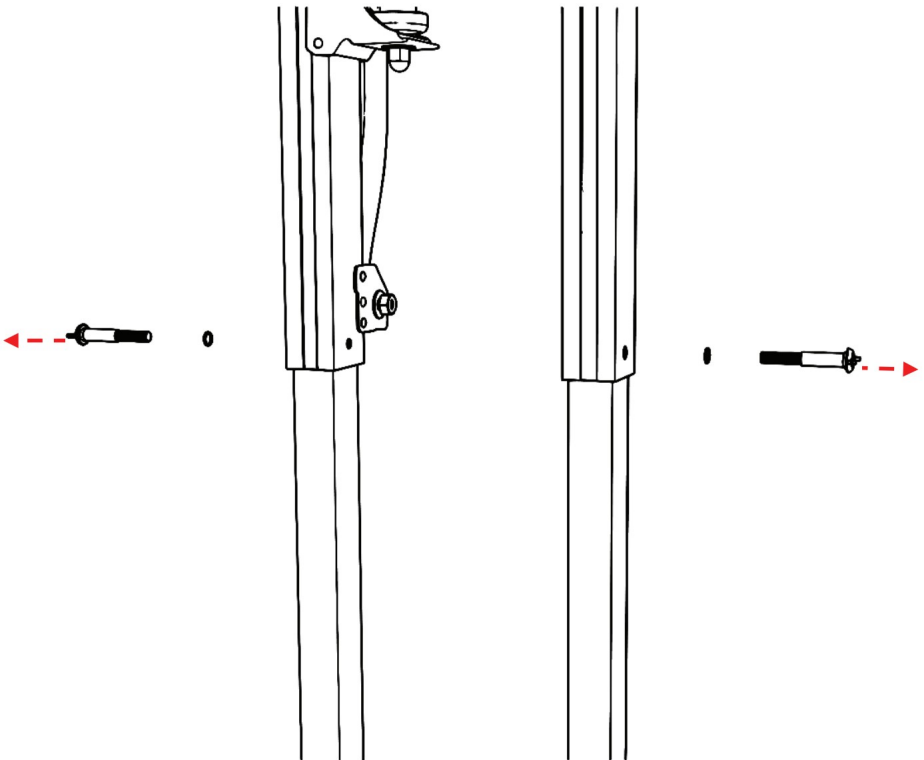

Loosen and separate the 4 bolts on the stilts.

2

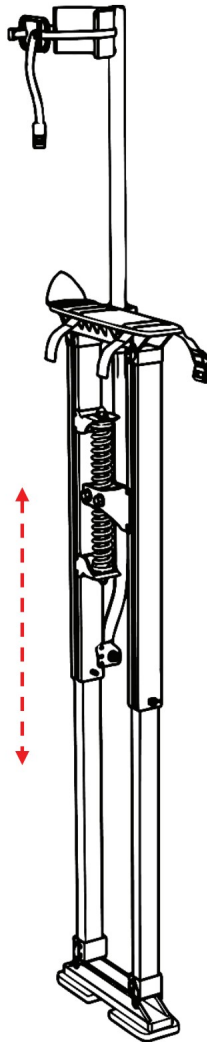

Adjust the height of the stilts. Ensure that the heights of both stilts are the same. After that, fasten the bolts.

Fabricant : Shanghaimuxinmuyeyouxiangongsi

Adresse : Shuangchenglu 803nong11hao1602A-1609shi, baoshanqu, shanghai 200000 CN.

Importé en AUS : SIHAO PTY LTD. 1 ROKEVA STREETEASTWOOD NSW 2122 Australie

Importé aux USA : Sanven Technology Ltd. Suite 250, 9166 Anaheim Place, Rancho Cucamonga, CA 91730



E-CrossStu GmbH
Mainzer Landstr.69,
60329 Francfort-sur-le-Main.



YH CONSULTING LIMITED. C/O YH Consulting
Limited Bureau 147, Centurion House, London
Road, Staines-upon-Thames, Surrey, TW18 4AX

VEVOR[®]

TOUGH TOOLS, HALF PRICE

Technical Support and E-Warranty Certificate

www.vevor.com/support

VEVOR[®]

TOUGH TOOLS, HALF PRICE

Technical Support and E-Warranty Certificate

www.vevor.com/support

DRYWALL STILTS USER MANUAL

We continue to be committed to provide you tools with competitive price.

"Save Half", "Half Price" or any other similar expressions used by us only represents an estimate of savings you might benefit from buying certain tools with us compared to the major top brands and does not necessarily mean to cover all categories of tools offered by us. You are kindly reminded to verify carefully when you are placing an order with us if you are actually saving half in comparison with the top major brands.

VEVOR[®]

DRYWALL STILTS USER MANUAL

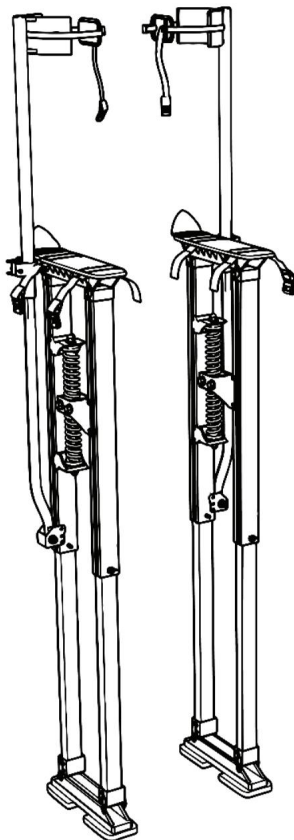

NEED HELP? CONTACT US!

Have product questions? Need technical support? Please feel free to contact us:

**Technischer Support und E-Garantie-
Zertifikat www.vevor.com/support**

This is the original instruction. Please read all manual instructions carefully before operating. VEVOR reserves a clear interpretation of our user manual. The appearance of the product shall be subject to the product you received. Please forgive us that we won't inform you again if there are any technology or software updates on our product.



Safety Instructions

1. Inspect the stilts thoroughly before use. Ensure that the parts are free of damage and that all the bolts and screws are fully tightened enough.
2. Use this product only on level and flat ground surfaces and there is no low profile furniture and other obstructions around.
3. When adjusting the height of the stilts, take them off your legs first for safety concerns.
4. Keep all straps fastened and secured before you walk on the stilts.
5. When walking on the stilts, never take a big step. Instead, make sure the stilts are raised well above the ground with each step.
6. Never use the stilts to walk on a slippery ground.
7. Never overload the stilts.
8. Walk slowly. Don't run or walk fast on the stilts.
9. Don't modify the stilts arbitrarily.
10. Don't walk on the stilts if you are influenced by alcohol or drugs.
11. Children are not allowed to use this product. Minors and seniors are not recommended to use this product.
12. Ensure the surrounding area is clean when using this product. Always wear protective gear (especially for the knee and elbow) and a helmet before using the product. It's recommended that the beginner uses two supporting sticks for balance.
13. It is forbidden to use this product on public roads or streets.
14. When using the product, it is recommended to wear anti-slip shoes.
15. The intended purpose of this product is for architectural decoration or ceiling repair. It is not for entertaining or dancing.
16. It's recommended to let the other 2 people assist the user stand on the stilts.

PACKAGE CONTENT

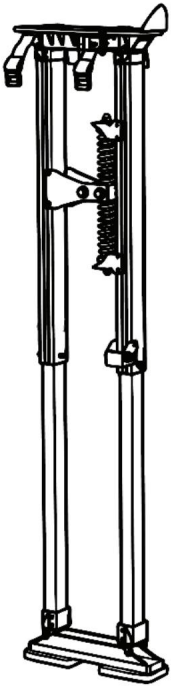

Skid-proof Rubber Sole x 2

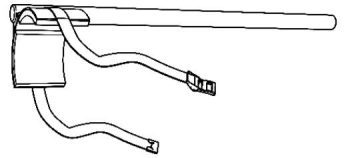

Metal Buckle x 2

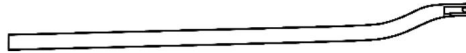

Supporting Stick x 2

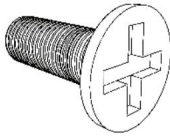

Bolt x 4

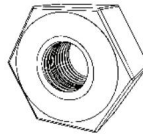

Nut x 4

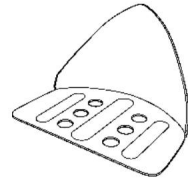

3-Position Heel Bracket x 2

SPECIFICATIONS

Modellreihe	HCST-18SI	HCST-24SI	HCST-24BK	HCST-36SI
Gesamtabmessungen (L x B x H)	32,5 x 10,8 x 5,3 Zoll (825 x 275 x 135 mm)	36,2" x 11" x 5,5" (920x280x140 mm)	36,2" x 11" x 5,5" (920x280x140 mm)	48" x 11" x 5,5" (1220x280x140 mm)
Gewichtskapazität	103 kg	228 Pfund (103 kg)	228 Pfund (103 kg)	103 kg
Einstellbare Höhe	18 bis 30 Zoll (457 bis 762 mm)	24 bis 40 Zoll (610 bis 1016 mm)	24 bis 40 Zoll (610 bis 1016 mm)	36" bis 50" (914 bis 1267 mm)

ASSEMBLY INSTRUCTIONS

The assembly procedures of the two stilts are the same. Here we take one stilt as an example. You can follow the same steps to finish the assembly for the other stilt.

1

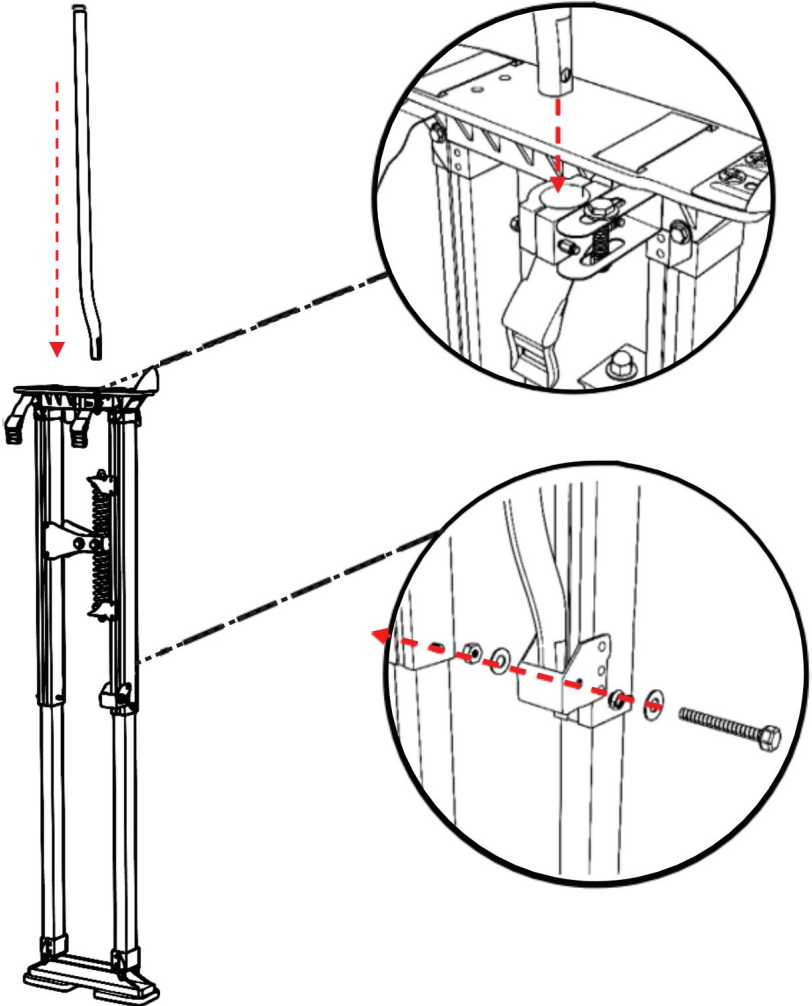

1. Insert the supporting stick through the side hole on the left stilt.
2. Secure the end of the supporting stick on the side bracket of the left stilt with the bolt and nut.
(The bolt and nut are preinstalled on the side bracket.)

2

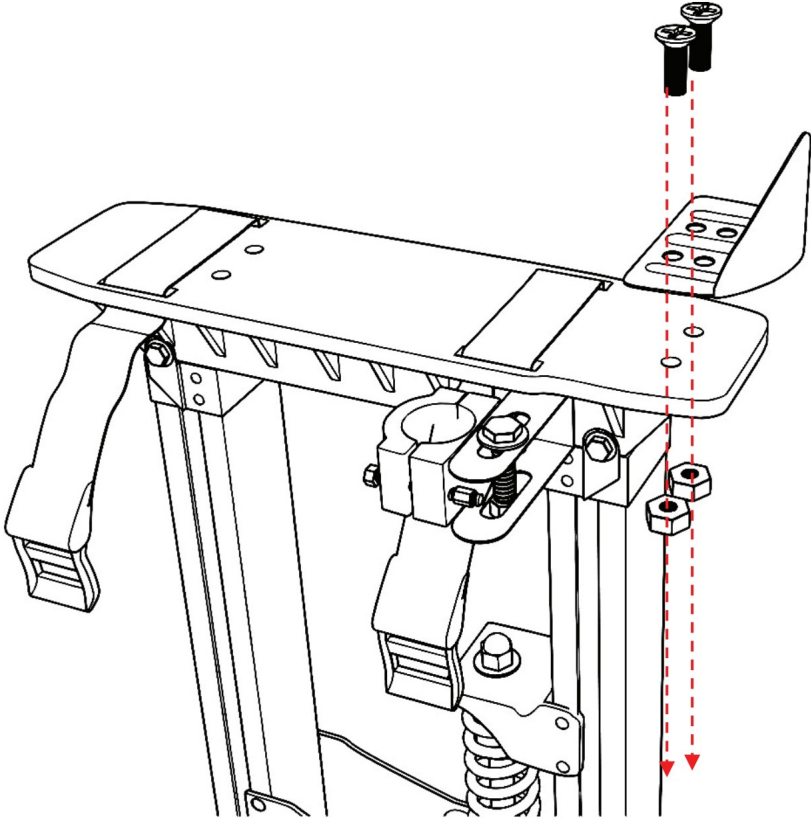

Install the heel bracket on the top of the stilt with two bolts and two nuts. Depending on the size of your feet, choose the front or back holes to install.

3

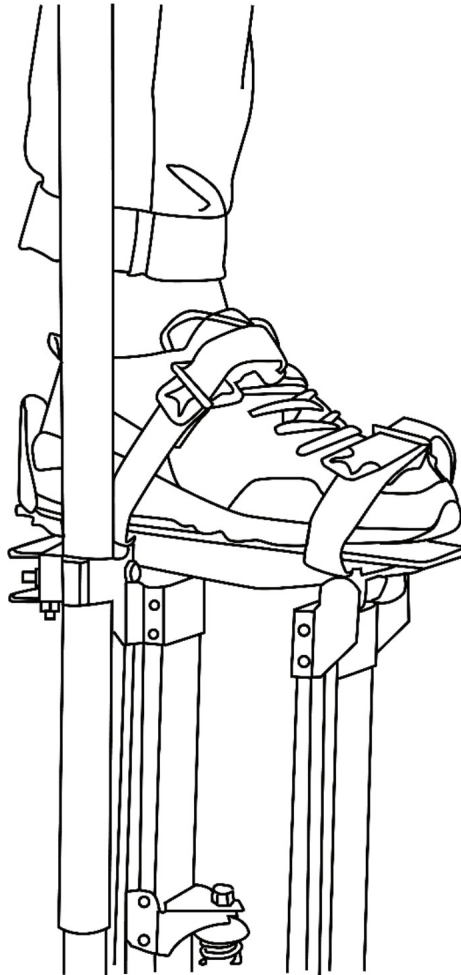

Use the straps on the stilt to secure your feet. Ensure that the straps are fastened tightly.

4

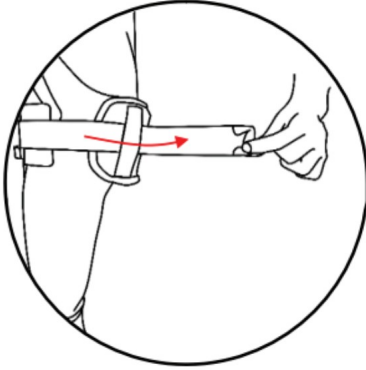

Thread the ends of the strap through the skid-proof rubber sole.

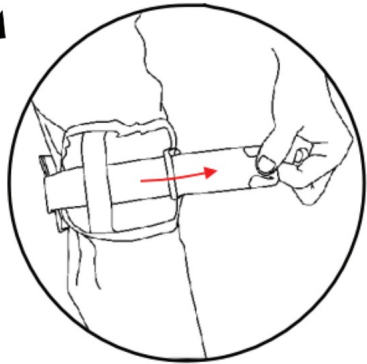

Thread the end of the strap through their buckles.

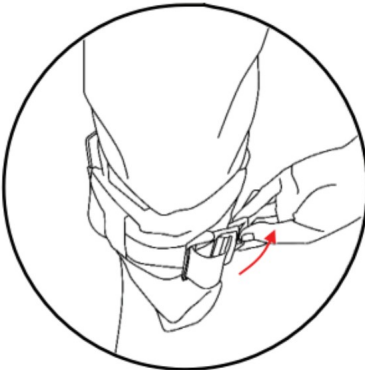

Fasten up the strap.

Ensure that the strap is fastened tightly and then the preparation is finished.

ADJUST THE STILT HEIGHT

NOTE:

Before adjusting the height of the stilts, take your feet off the stilts first.

1

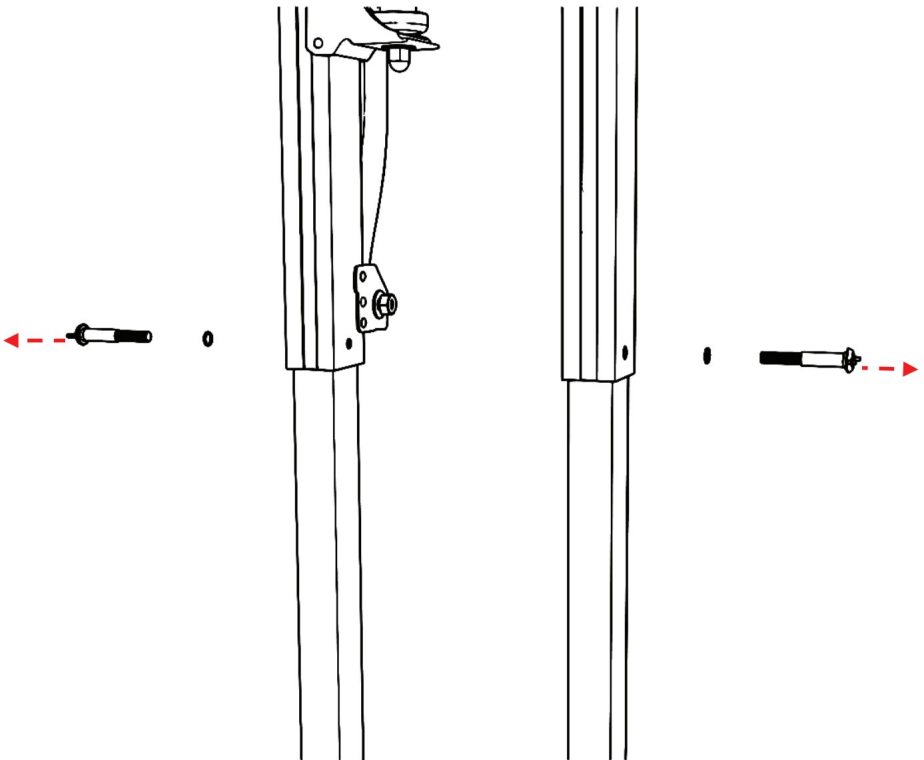

Loosen and separate the 4 bolts on the stilts.

2

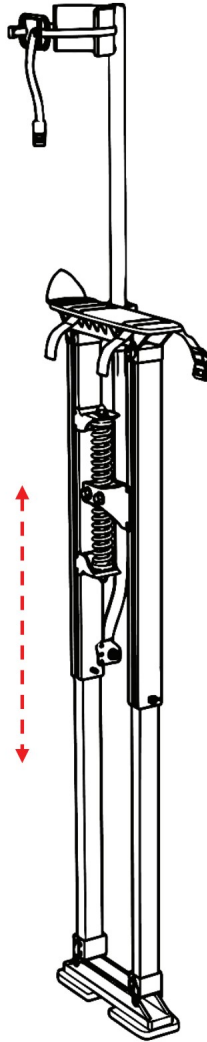

Adjust the height of the stilts. Ensure that the heights of both stilts are the same. After that, fasten the bolts.

Hersteller: Shanghaimuxinmuyeyouxiangongsi Adresse:
Shuangchenglu 803nong11hao1602A-1609shi, baoshanqu, Shanghai
200000 CN.

Importiert nach AUS: SIHAO PTY LTD. 1 ROKEVA STREETEASTWOOD
NSW 2122 Australien

Importiert nach USA: Sanven Technology Ltd. Suite 250, 9166 Anaheim Place,
Rancho Cucamonga, CA 91730



E-CrossStu GmbH
Mainzer Landstr.69,
60329 Frankfurt am Main.



YH CONSULTING LIMITED. C/O YH Consulting
Limited Office 147, Centurion House, London
Road, Staines-upon-Thames, Surrey, TW18 4AX

VEVOR[®]

TOUGH TOOLS, HALF PRICE

Technical Support and E-Warranty Certificate

www.vevor.com/support

VEVOR[®]

TOUGH TOOLS, HALF PRICE

Technical Support and E-Warranty Certificate

www.vevor.com/support

DRYWALL STILTS USER MANUAL

We continue to be committed to provide you tools with competitive price.

"Save Half", "Half Price" or any other similar expressions used by us only represents an estimate of savings you might benefit from buying certain tools with us compared to the major top brands and does not necessarily mean to cover all categories of tools offered by us. You are kindly reminded to verify carefully when you are placing an order with us if you are actually saving half in comparison with the top major brands.

VEVOR[®]

DRYWALL STILTS USER MANUAL

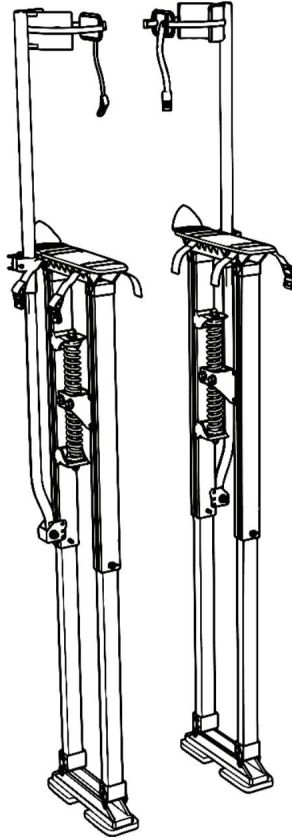

NEED HELP? CONTACT US!

Have product questions? Need technical support? Please feel free to contact us:

**Supporto tecnico e certificato di garanzia
elettronica www.vevor.com/support**

This is the original instruction. Please read all manual instructions carefully before operating. VEVOR reserves a clear interpretation of our user manual. The appearance of the product shall be subject to the product you received. Please forgive us that we won't inform you again if there are any technology or software updates on our product.



Safety Instructions

1. Inspect the stilts thoroughly before use. Ensure that the parts are free of damage and that all the bolts and screws are fully tightened enough.
2. Use this product only on level and flat ground surfaces and there is no low profile furniture and other obstructions around.
3. When adjusting the height of the stilts, take them off your legs first for safety concerns.
4. Keep all straps fastened and secured before you walk on the stilts.
5. When walking on the stilts, never take a big step. Instead, make sure the stilts are raised well above the ground with each step.
6. Never use the stilts to walk on a slippery ground.
7. Never overload the stilts.
8. Walk slowly. Don't run or walk fast on the stilts.
9. Don't modify the stilts arbitrarily.
10. Don't walk on the stilts if you are influenced by alcohol or drugs.
11. Children are not allowed to use this product. Minors and seniors are not recommended to use this product.
12. Ensure the surrounding area is clean when using this product. Always wear protective gear (especially for the knee and elbow) and a helmet before using the product. It's recommended that the beginner uses two supporting sticks for balance.
13. It is forbidden to use this product on public roads or streets.
14. When using the product, it is recommended to wear anti-slip shoes.
15. The intended purpose of this product is for architectural decoration or ceiling repair. It is not for entertaining or dancing.
16. It's recommended to let the other 2 people assist the user stand on the stilts.

PACKAGE CONTENT

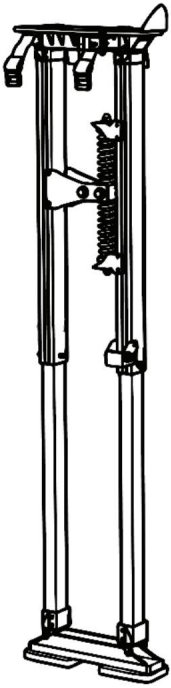

Skid-proof Rubber Sole x 2

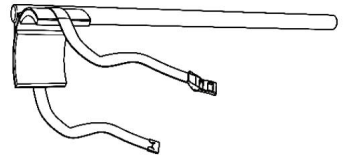

Metal Buckle x 2

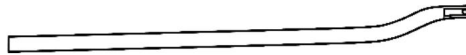

Supporting Stick x 2

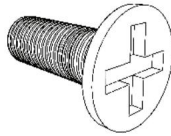

Bolt x 4

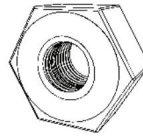

Nut x 4

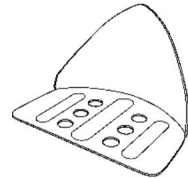

3-Position Heel Bracket x 2

SPECIFICATIONS

Serie di modelli	HCST-18SI	HCST-24SI	HCST-24BK	HCST-36SI
Dimensioni complessive (L x P x A)	Dimensioni: 32,5" x 10,8" x 5,3" (825x275x135 mm)	Dimensioni: 36,2" x 11" x 5,5" (920x280x140 mm)	Dimensioni: 36,2" x 11" x 5,5" (920x280x140 mm)	Dimensioni: 48" x 11" x 5,5" (1220x280x140 mm)
Capacità di peso	228 libbre (103 kg)	228 libbre (103 chili)	228 libbre (103 chili)	228 libbre (103 kg)
Altezza regolabile	Da 18" a 30" (da 457 a 762 mm)	Da 24" a 40" (da 610 a 1016 mm)	Da 24" a 40" (da 610 a 1016 mm)	Da 36" a 50" (da 914 a 1267 mm)

ASSEMBLY INSTRUCTIONS

The assembly procedures of the two stilts are the same. Here we take one stilt as an example. You can follow the same steps to finish the assembly for the other stilt.

1

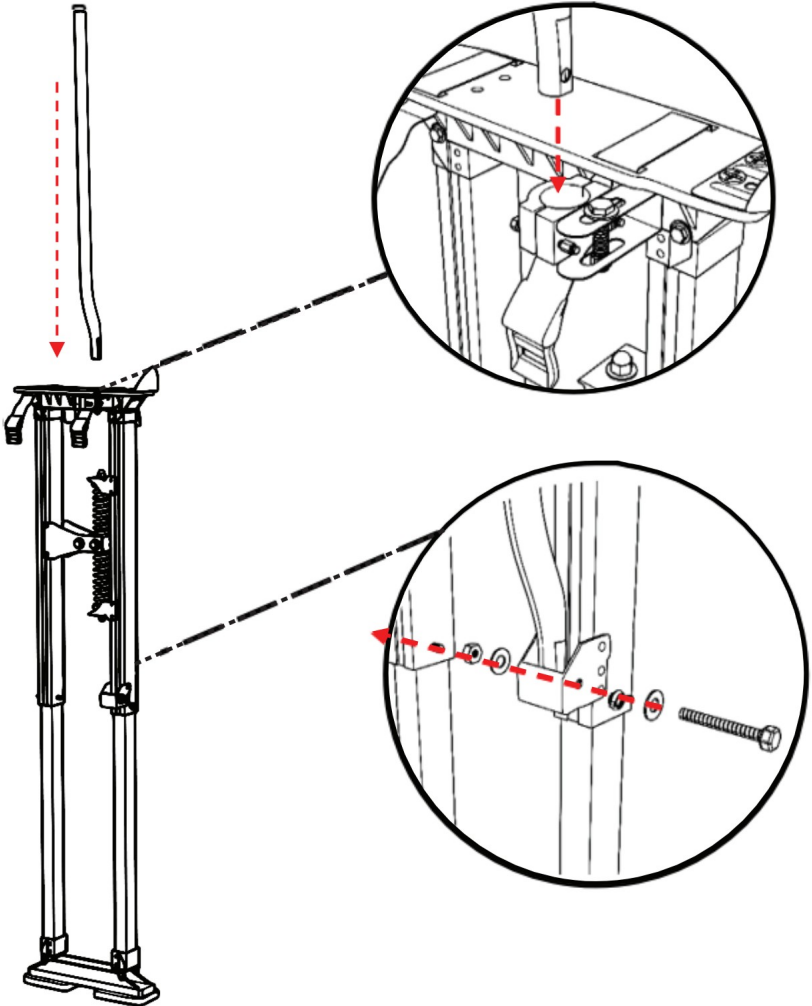

1. Insert the supporting stick through the side hole on the left stilt.
2. Secure the end of the supporting stick on the side bracket of the left stilt with the bolt and nut.
(The bolt and nut are preinstalled on the side bracket.)

2

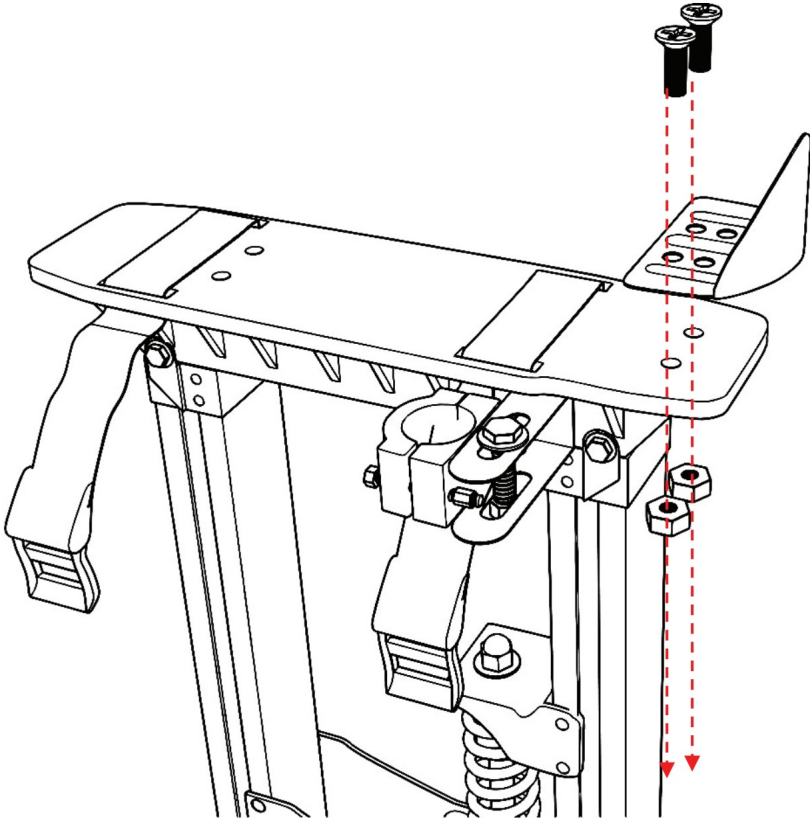

Install the heel bracket on the top of the stilt with two bolts and two nuts. Depending on the size of your feet, choose the front or back holes to install.

3



Use the straps on the stilt to secure your feet. Ensure that the straps are fastened tightly.

4

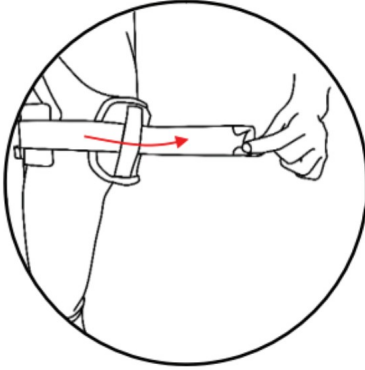

Thread the ends of the strap through the skid-proof rubber sole.

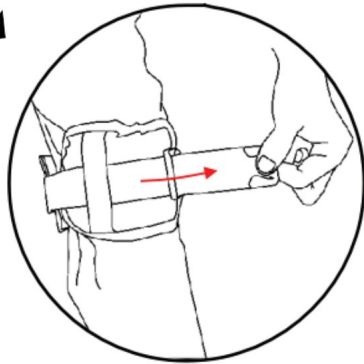

Thread the end of the strap through their buckles.

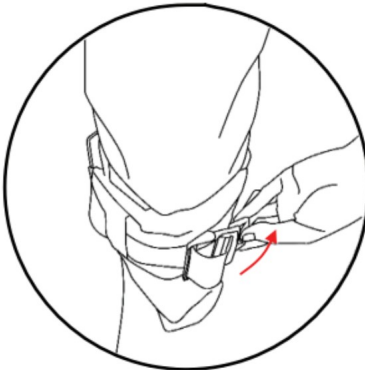

Fasten up the strap.

Ensure that the strap is fastened tightly and then the preparation is finished.

ADJUST THE STILT HEIGHT

NOTE:

Before adjusting the height of the stilts, take your feet off the stilts first.

1

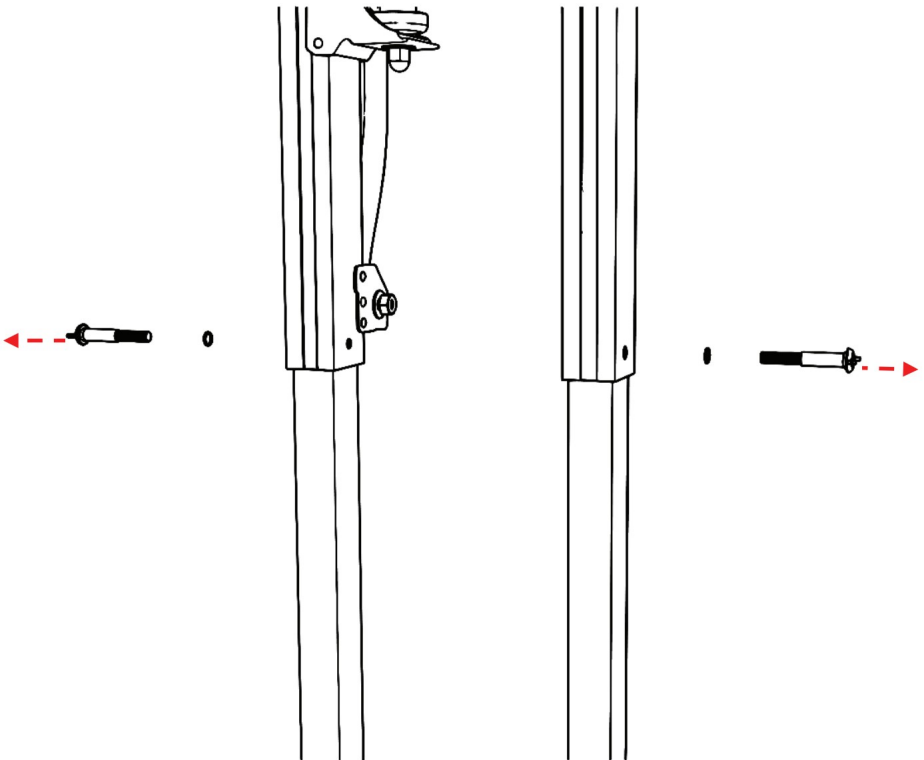

Loosen and separate the 4 bolts on the stilts.

2

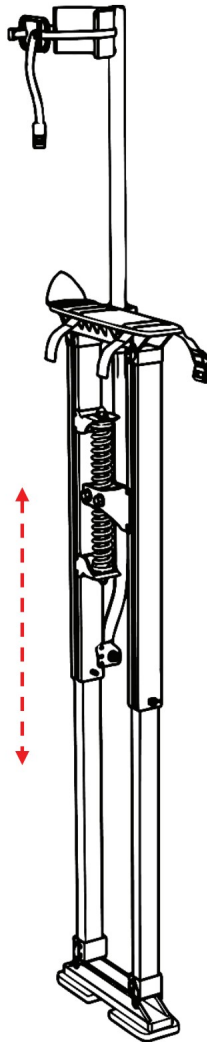

Adjust the height of the stilts. Ensure that the heights of both stilts are the same. After that, fasten the bolts.

Produttore: Shnghaimuxinmuyeyouxiangongsi

Indirizzo: Shuangchenglu 803nong11hao1602A-1609shi, baoshanqu,
shanghai 200000 CN.

Importato in AUS: SIHAO PTY LTD. 1 ROKEVA STREETEASTWOOD
NSW 2122 Australia

Importato negli USA: Sanven Technology Ltd. Suite 250, 9166 Anaheim Place,
Rancho Cucamonga, CA 91730



E-CrossStu GmbH
Mainzer Landstr.69,
60329 Francoforte sul Meno.



YH CONSULTING LIMITED. C/O YH Consulting
Limited Ufficio 147, Centurion House, London
Road, Staines-upon-Thames, Surrey, TW18 4AX

VEVOR[®]

TOUGH TOOLS, HALF PRICE

Technical Support and E-Warranty Certificate

www.vevor.com/support

VEVOR[®]

TOUGH TOOLS, HALF PRICE

Technical Support and E-Warranty Certificate

www.vevor.com/support

DRYWALL STILTS USER MANUAL

We continue to be committed to provide you tools with competitive price.

"Save Half", "Half Price" or any other similar expressions used by us only represents an estimate of savings you might benefit from buying certain tools with us compared to the major top brands and does not necessarily mean to cover all categories of tools offered by us. You are kindly reminded to verify carefully when you are placing an order with us if you are actually saving half in comparison with the top major brands.

VEVOR[®]

DRYWALL STILTS USER MANUAL

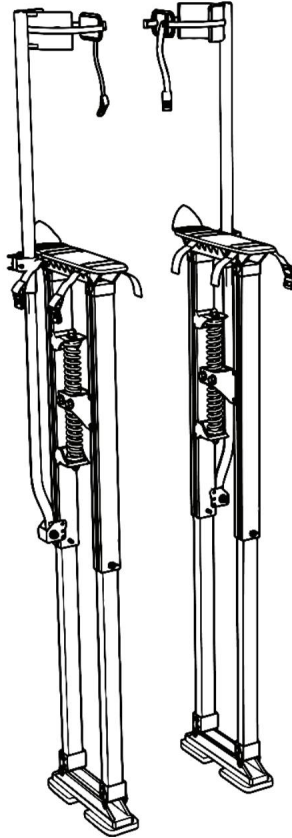

NEED HELP? CONTACT US!

Have product questions? Need technical support? Please feel free to contact us:

Soporte técnico y certificado de garantía

electrónica www.vevor.com/support

This is the original instruction. Please read all manual instructions carefully before operating. VEVOR reserves a clear interpretation of our user manual. The appearance of the product shall be subject to the product you received. Please forgive us that we won't inform you again if there are any technology or software updates on our product.



Safety Instructions

1. Inspect the stilts thoroughly before use. Ensure that the parts are free of damage and that all the bolts and screws are fully tightened enough.
2. Use this product only on level and flat ground surfaces and there is no low profile furniture and other obstructions around.
3. When adjusting the height of the stilts, take them off your legs first for safety concerns.
4. Keep all straps fastened and secured before you walk on the stilts.
5. When walking on the stilts, never take a big step. Instead, make sure the stilts are raised well above the ground with each step.
6. Never use the stilts to walk on a slippery ground.
7. Never overload the stilts.
8. Walk slowly. Don't run or walk fast on the stilts.
9. Don't modify the stilts arbitrarily.
10. Don't walk on the stilts if you are influenced by alcohol or drugs.
11. Children are not allowed to use this product. Minors and seniors are not recommended to use this product.
12. Ensure the surrounding area is clean when using this product. Always wear protective gear (especially for the knee and elbow) and a helmet before using the product. It's recommended that the beginner uses two supporting sticks for balance.
13. It is forbidden to use this product on public roads or streets.
14. When using the product, it is recommended to wear anti-slip shoes.
15. The intended purpose of this product is for architectural decoration or ceiling repair. It is not for entertaining or dancing.
16. It's recommended to let the other 2 people assist the user stand on the stilts.

PACKAGE CONTENT

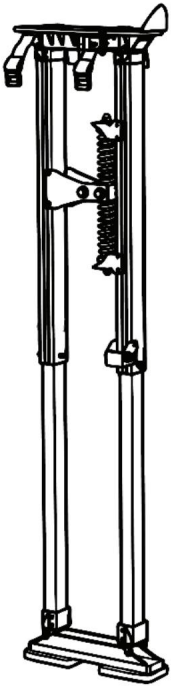

Skid-proof Rubber Sole x 2

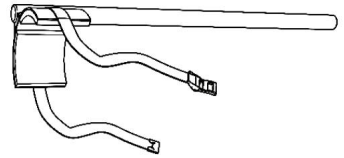

Metal Buckle x 2

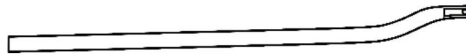

Supporting Stick x 2

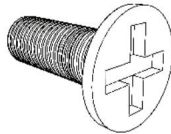

Bolt x 4

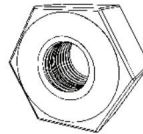

Nut x 4

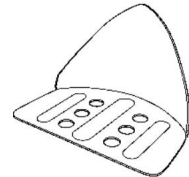

3-Position Heel Bracket x 2

SPECIFICATIONS

Serie de modelos	HCST-18SI	HCST-24SI	HCST-24BK	HCST-36SI
Dimensiones generales (Largo x Ancho x Alto)	32,5" x 10,8" x 5,3" (825 x 275 x 135 mm)	36,2" x 11" x 5,5" (920 x 280 x 140 mm)	36,2" x 11" x 5,5" (920 x 280 x 140 mm)	48" x 11" x 5,5" (1220 x 280 x 140 mm)
Capacidad de peso	228 libras (103 kg)	228 libras (103 kilos)	228 libras (103 kilos)	228 libras (103 kg)
Altura ajustable	De 18" a 30" (457 a 762 mm)	24" a 40" (610 a 1016 mm)	24" a 40" (610 a 1016 mm)	De 36" a 50" (914 a 1267 mm)

ASSEMBLY INSTRUCTIONS

The assembly procedures of the two stilts are the same. Here we take one stilt as an example. You can follow the same steps to finish the assembly for the other stilt.

1

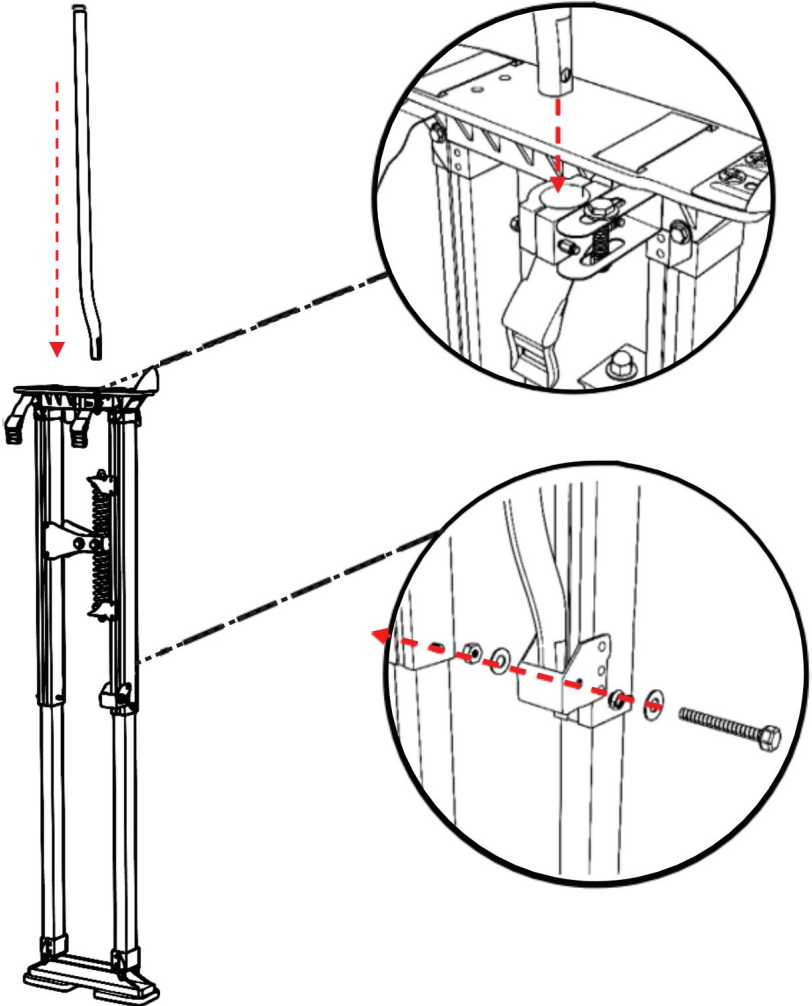

1. Insert the supporting stick through the side hole on the left stilt.
2. Secure the end of the supporting stick on the side bracket of the left stilt with the bolt and nut.
(The bolt and nut are preinstalled on the side bracket.)

2

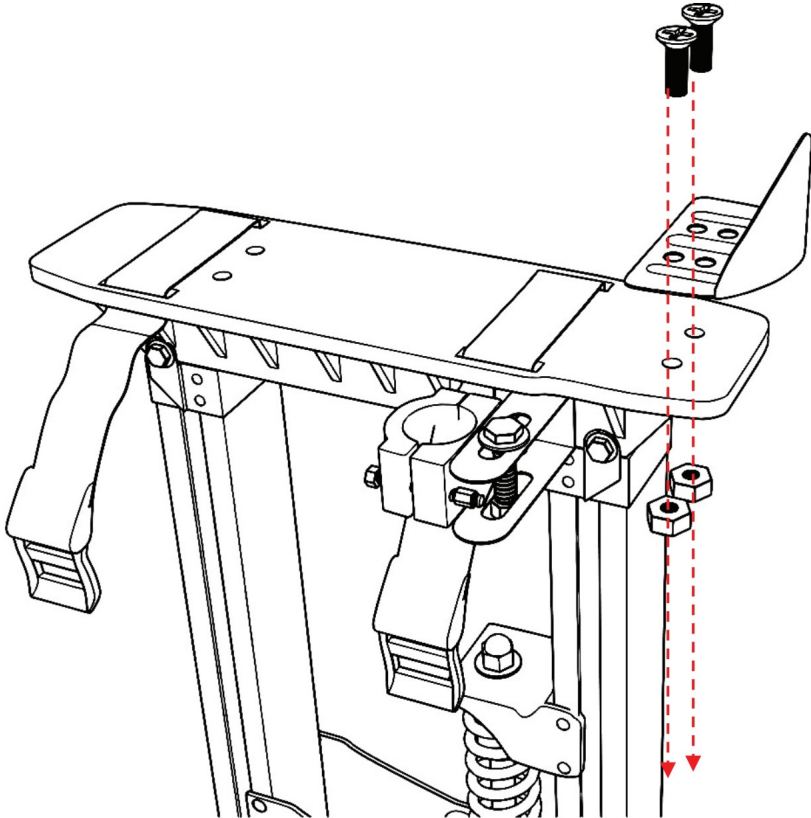

Install the heel bracket on the top of the stilt with two bolts and two nuts. Depending on the size of your feet, choose the front or back holes to install.

3



Use the straps on the stilt to secure your feet. Ensure that the straps are fastened tightly.

4

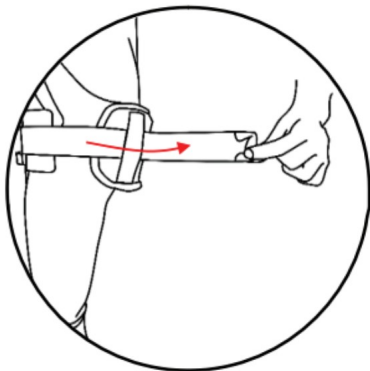

Thread the ends of the strap through the skid-proof rubber sole.



Thread the end of the strap through their buckles.

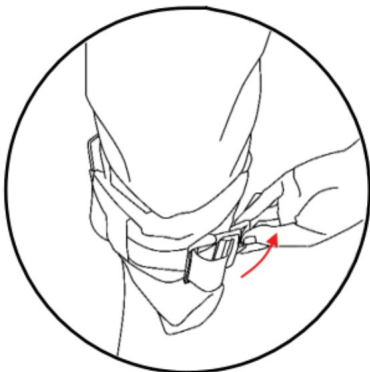
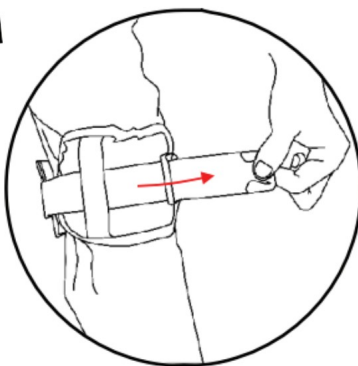

Fasten up the strap.

Ensure that the strap is fastened tightly and then the preparation is finished.

ADJUST THE STILT HEIGHT

NOTE:

Before adjusting the height of the stilts, take your feet off the stilts first.

1

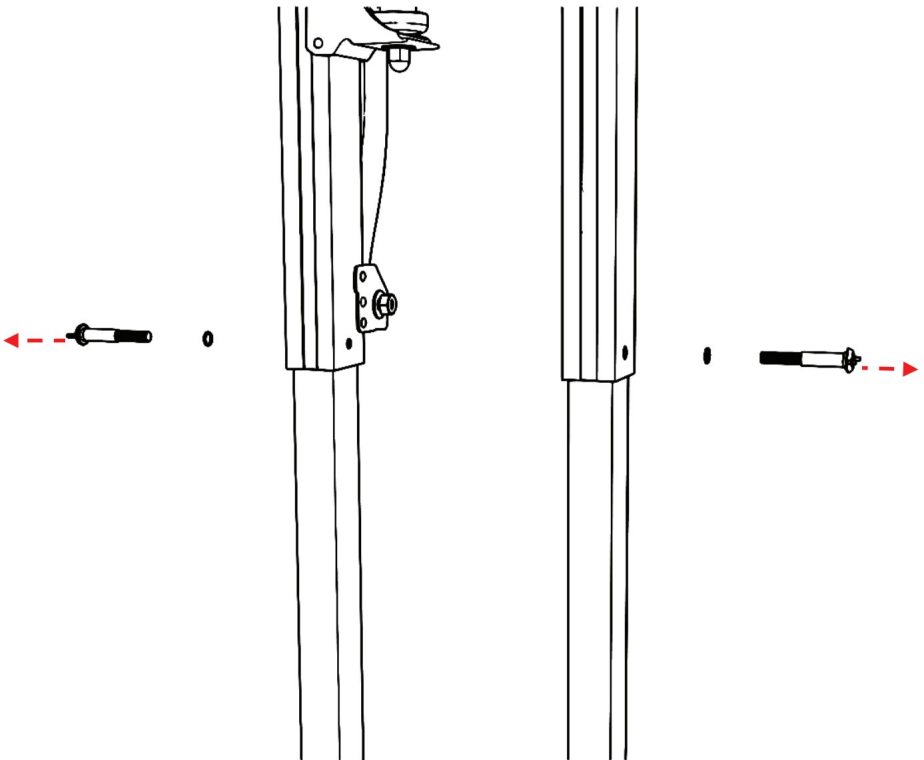

Loosen and separate the 4 bolts on the stilts.

2

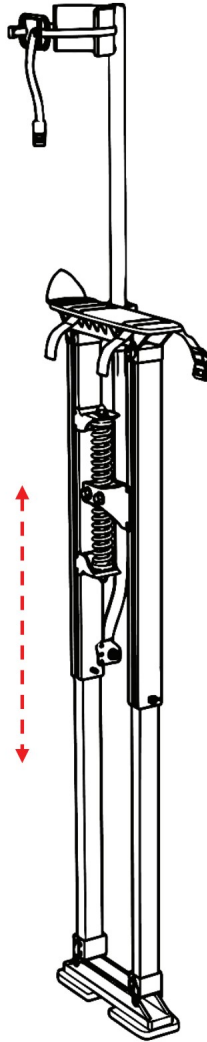

Adjust the height of the stilts. Ensure that the heights of both stilts are the same. After that, fasten the bolts.

Fabricante: Shanghaimuxinmuyeyouxiangongsi

Dirección: Shuangchenglu 803nong11hao1602A-1609shi, baoshanqu, shanghai 200000 CN.

Importado a AUS: SIHAO PTY LTD. 1 ROKEVA STREETEASTWOOD NSW 2122 Australia

Importado a EE. UU.: Sanven Technology Ltd. Suite 250, 9166 Anaheim Place, Rancho Cucamonga, CA 91730



E-CrossStu GmbH
Mainzer Landstr.69,
60329 Fráncfort del Meno.



YH CONSULTING LIMITED. A LA DIRECCIÓN DE
YH Consulting Limited Oficina 147, Centurion House,
London Road, Staines-upon-Thames, Surrey, TW18 4AX

VEVOR[®]

TOUGH TOOLS, HALF PRICE

Technical Support and E-Warranty Certificate

www.vevor.com/support

VEVOR[®]

TOUGH TOOLS, HALF PRICE

Technical Support and E-Warranty Certificate

www.vevor.com/support

DRYWALL STILTS USER MANUAL

We continue to be committed to provide you tools with competitive price.

"Save Half", "Half Price" or any other similar expressions used by us only represents an estimate of savings you might benefit from buying certain tools with us compared to the major top brands and does not necessarily mean to cover all categories of tools offered by us. You are kindly reminded to verify carefully when you are placing an order with us if you are actually saving half in comparison with the top major brands.

VEVOR[®]

DRYWALL STILTS USER MANUAL

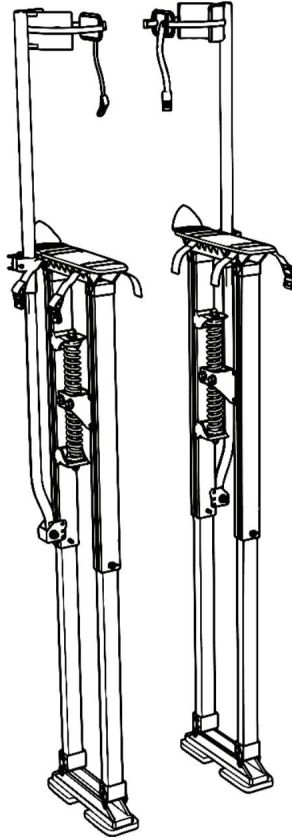

NEED HELP? CONTACT US!

Have product questions? Need technical support? Please feel free to contact us:

Wsparcie techniczne i certyfikat gwarancji

elektronicznej www.vevor.com/support

This is the original instruction. Please read all manual instructions carefully before operating. VEVOR reserves a clear interpretation of our user manual. The appearance of the product shall be subject to the product you received. Please forgive us that we won't inform you again if there are any technology or software updates on our product.



Safety Instructions

1. Inspect the stilts thoroughly before use. Ensure that the parts are free of damage and that all the bolts and screws are fully tightened enough.
2. Use this product only on level and flat ground surfaces and there is no low profile furniture and other obstructions around.
3. When adjusting the height of the stilts, take them off your legs first for safety concerns.
4. Keep all straps fastened and secured before you walk on the stilts.
5. When walking on the stilts, never take a big step. Instead, make sure the stilts are raised well above the ground with each step.
6. Never use the stilts to walk on a slippery ground.
7. Never overload the stilts.
8. Walk slowly. Don't run or walk fast on the stilts.
9. Don't modify the stilts arbitrarily.
10. Don't walk on the stilts if you are influenced by alcohol or drugs.
11. Children are not allowed to use this product. Minors and seniors are not recommended to use this product.
12. Ensure the surrounding area is clean when using this product. Always wear protective gear (especially for the knee and elbow) and a helmet before using the product. It's recommended that the beginner uses two supporting sticks for balance.
13. It is forbidden to use this product on public roads or streets.
14. When using the product, it is recommended to wear anti-slip shoes.
15. The intended purpose of this product is for architectural decoration or ceiling repair. It is not for entertaining or dancing.
16. It's recommended to let the other 2 people assist the user stand on the stilts.

PACKAGE CONTENT

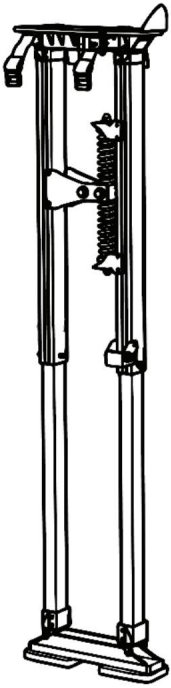

Skid-proof Rubber Sole x 2

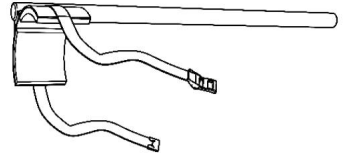

Metal Buckle x 2

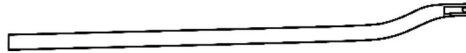

Supporting Stick x 2

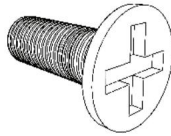

Bolt x 4

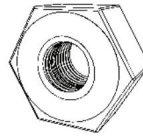

Nut x 4

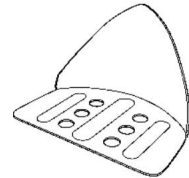

3-Position Heel Bracket x 2

SPECIFICATIONS

Seria modeli	HCST-18SI	HCST-24SI	HCST-24BK	HCST-36SI
Wymiary całkowite (Dł. x szer. x wys.)	32,5" x 10,8" x 5,3" (825×275×135 mm)	36,2" x 11" x 5,5" (920×280×140 mm)	36,2" x 11" x 5,5" (920×280×140 mm)	48" x 11" x 5,5" (1220×280×140 mm)
Nośność	228 funtów (103 kg)	228 funtów (103 kilogramy)	228 funtów (103 kilogramy)	228 funtów (103 kg)
Regulowana wysokość	18" do 30" (457 do 762 mm)	24" do 40" (610 do 1016 mm)	24" do 40" (610 do 1016 mm)	36" do 50" (914 do 1267 mm)

ASSEMBLY INSTRUCTIONS

The assembly procedures of the two stilts are the same. Here we take one stilt as an example. You can follow the same steps to finish the assembly for the other stilt.

1

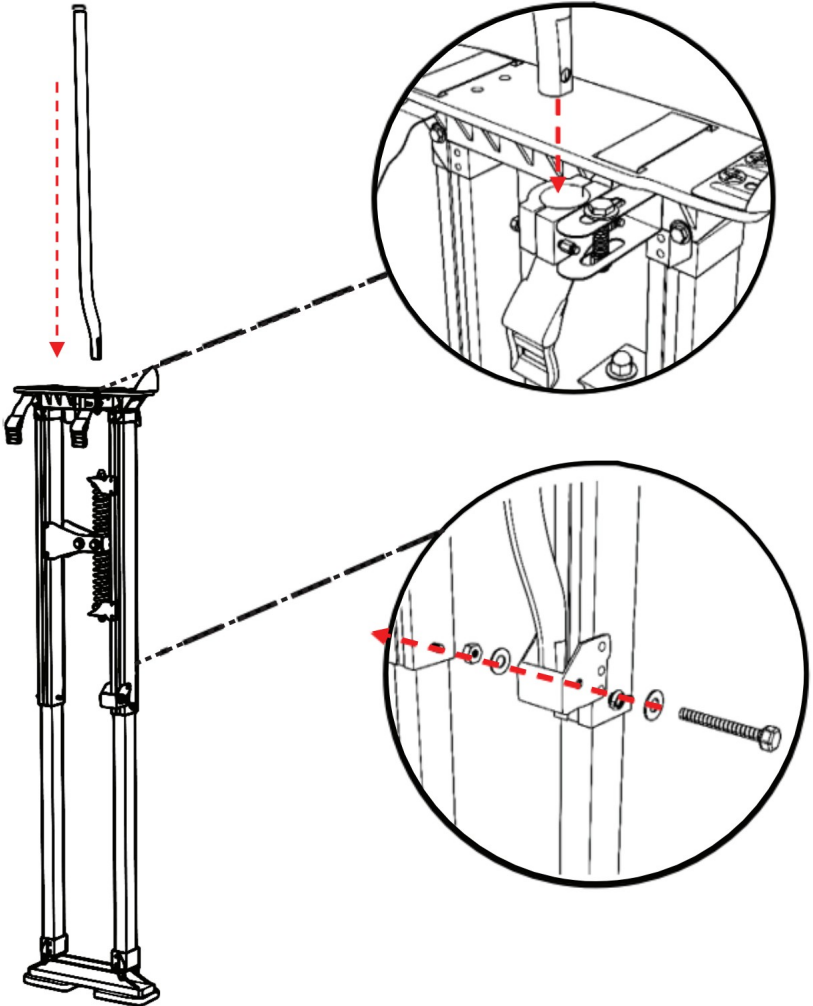

1. Insert the supporting stick through the side hole on the left stilt.
2. Secure the end of the supporting stick on the side bracket of the left stilt with the bolt and nut.
(The bolt and nut are preinstalled on the side bracket.)

2

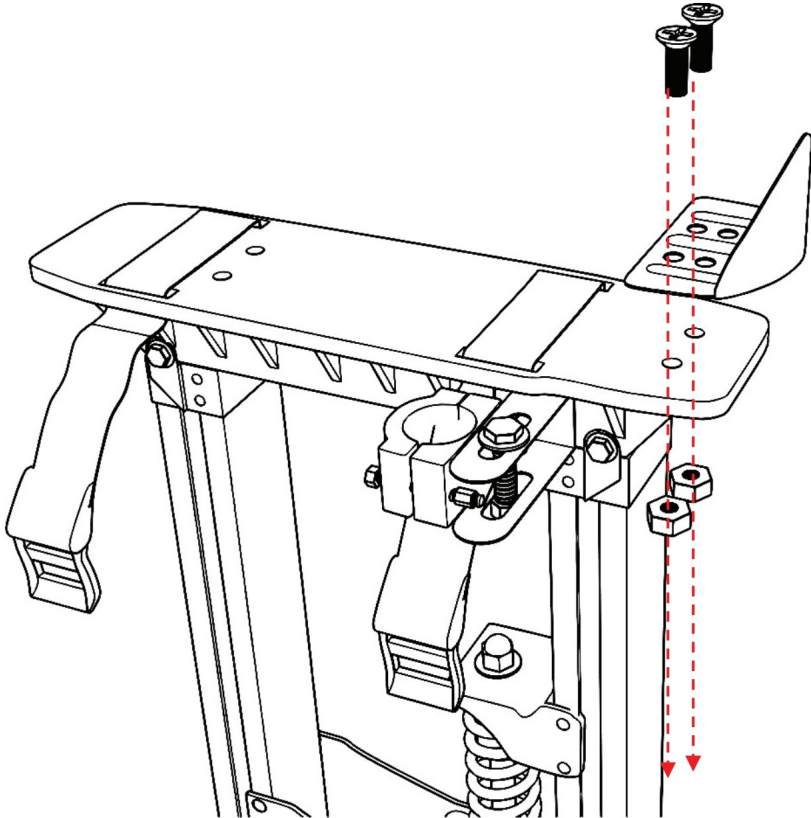

Install the heel bracket on the top of the stilt with two bolts and two nuts. Depending on the size of your feet, choose the front or back holes to install.

3



Use the straps on the stilt to secure your feet. Ensure that the straps are fastened tightly.

4

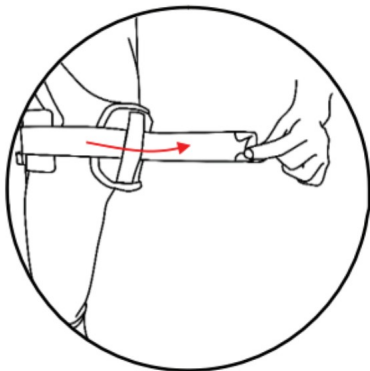

Thread the ends of the strap through the skid-proof rubber sole.



Thread the end of the strap through their buckles.

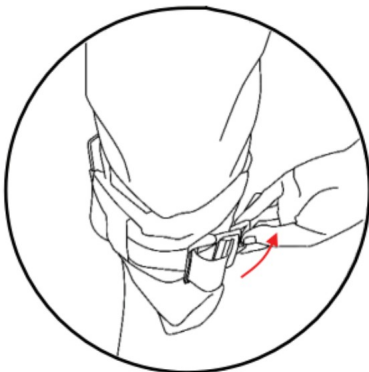
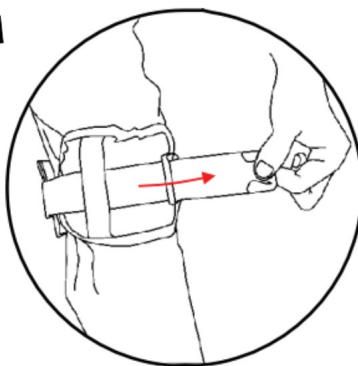

Fasten up the strap.

Ensure that the strap is fastened tightly and then the preparation is finished.

ADJUST THE STILT HEIGHT

NOTE:

Before adjusting the height of the stilts, take your feet off the stilts first.

1

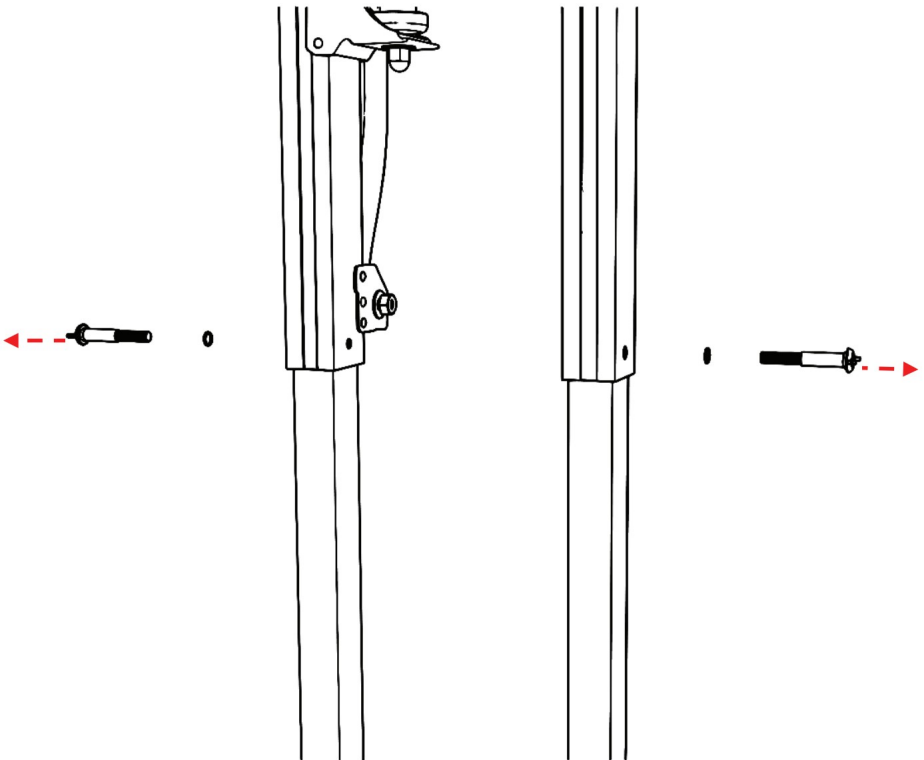

Loosen and separate the 4 bolts on the stilts.

2

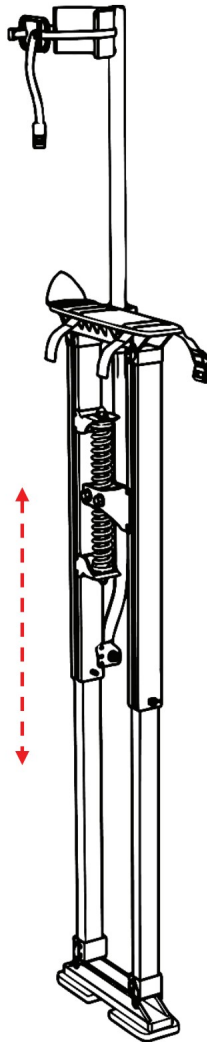

Adjust the height of the stilts. Ensure that the heights of both stilts are the same. After that, fasten the bolts.

Producent: Shanghaimuxinmuyeyouxiangongsi Adres:
Shuangchenglu 803nong11hao1602A-1609shi, baoshanqu, szanghaj
200000 CN.

Importowane do AUS: SIHAO PTY LTD. 1 ROKEVA STREETEASTWOOD
NSW 2122 Australia

Importowane do USA: Sanven Technology Ltd. Suite 250, 9166 Anaheim Place,
Rancho Cucamonga, CA 91730



E-CrossStu GmbH
Mainzer Landstr.69,
60329 Frankfurt nad Menem.



YH CONSULTING LIMITED. C/O YH Consulting
Limited Biuro 147, Centurion House, London
Road, Staines-upon-Thames, Surrey, TW18 4AX

VEVOR[®]

TOUGH TOOLS, HALF PRICE

Technical Support and E-Warranty Certificate

www.vevor.com/support

VEVOR[®]

TOUGH TOOLS, HALF PRICE

Technical Support and E-Warranty Certificate

www.vevor.com/support

DRYWALL STILTS USER MANUAL

We continue to be committed to provide you tools with competitive price.

"Save Half", "Half Price" or any other similar expressions used by us only represents an estimate of savings you might benefit from buying certain tools with us compared to the major top brands and does not necessarily mean to cover all categories of tools offered by us. You are kindly reminded to verify carefully when you are placing an order with us if you are actually saving half in comparison with the top major brands.

VEVOR[®]

DRYWALL STILTS USER MANUAL

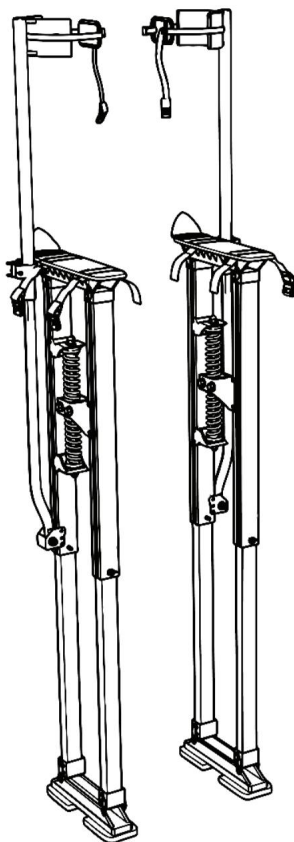

NEED HELP? CONTACT US!

Have product questions? Need technical support? Please feel free to contact us:

**Technische ondersteuning en e-
garantiecertificaat www.vevor.com/support**

This is the original instruction. Please read all manual instructions carefully before operating. VEVOR reserves a clear interpretation of our user manual. The appearance of the product shall be subject to the product you received. Please forgive us that we won't inform you again if there are any technology or software updates on our product.



Safety Instructions

1. Inspect the stilts thoroughly before use. Ensure that the parts are free of damage and that all the bolts and screws are fully tightened enough.
2. Use this product only on level and flat ground surfaces and there is no low profile furniture and other obstructions around.
3. When adjusting the height of the stilts, take them off your legs first for safety concerns.
4. Keep all straps fastened and secured before you walk on the stilts.
5. When walking on the stilts, never take a big step. Instead, make sure the stilts are raised well above the ground with each step.
6. Never use the stilts to walk on a slippery ground.
7. Never overload the stilts.
8. Walk slowly. Don't run or walk fast on the stilts.
9. Don't modify the stilts arbitrarily.
10. Don't walk on the stilts if you are influenced by alcohol or drugs.
11. Children are not allowed to use this product. Minors and seniors are not recommended to use this product.
12. Ensure the surrounding area is clean when using this product. Always wear protective gear (especially for the knee and elbow) and a helmet before using the product. It's recommended that the beginner uses two supporting sticks for balance.
13. It is forbidden to use this product on public roads or streets.
14. When using the product, it is recommended to wear anti-slip shoes.
15. The intended purpose of this product is for architectural decoration or ceiling repair. It is not for entertaining or dancing.
16. It's recommended to let the other 2 people assist the user stand on the stilts.

PACKAGE CONTENT

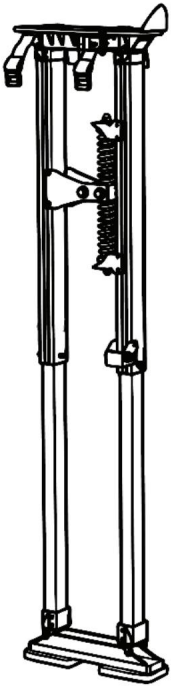

Skid-proof Rubber Sole x 2

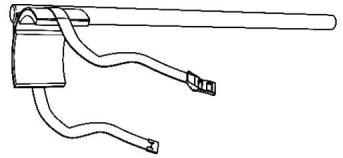

Metal Buckle x 2

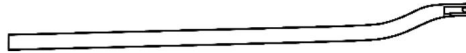

Supporting Stick x 2

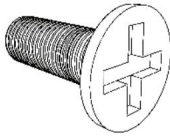

Bolt x 4

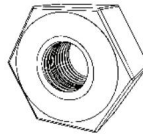

Nut x 4

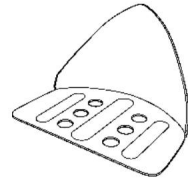

3-Position Heel Bracket x 2

SPECIFICATIONS

Modelserie	HCST-18SI	HCST-24SI	HCST-24BK	HCST-36SI
Totale afmetingen (L x B x H)	825x275x135mm (32,5" x 10,8" x 5,3")	920x280x140 mm (36,2" x 11" x 5,5")	920x280x140 mm (36,2" x 11" x 5,5")	48" x 11" x 5,5" (1220x280x140 mm)
Draagvermogen	228 pond (103 kg)	228 pond (103kg)	228 pond (103kg)	228 pond (103 kg)
Verstelbare hoogte	18" tot 30" (457 tot 762 mm)	24" tot 40" (610 tot 1016 mm)	24" tot 40" (610 tot 1016 mm)	36" tot 50" (914 tot 1267 mm)

ASSEMBLY INSTRUCTIONS

The assembly procedures of the two stilts are the same. Here we take one stilt as an example. You can follow the same steps to finish the assembly for the other stilt.

1

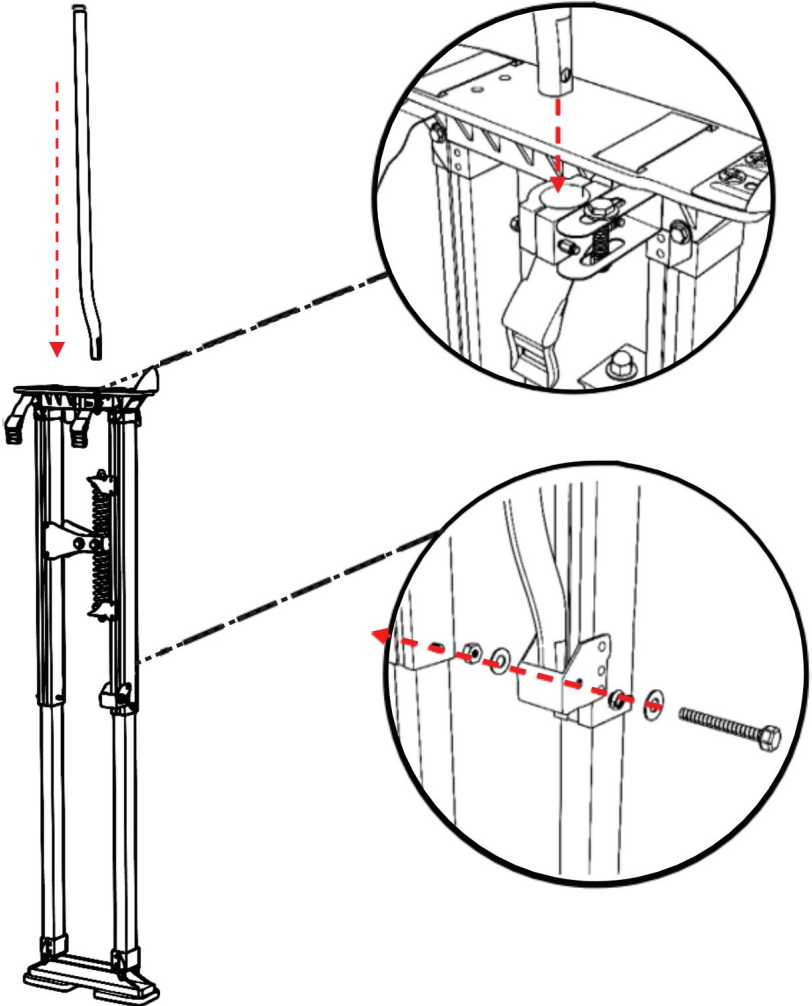

1. Insert the supporting stick through the side hole on the left stilt.
2. Secure the end of the supporting stick on the side bracket of the left stilt with the bolt and nut.
(The bolt and nut are preinstalled on the side bracket.)

2

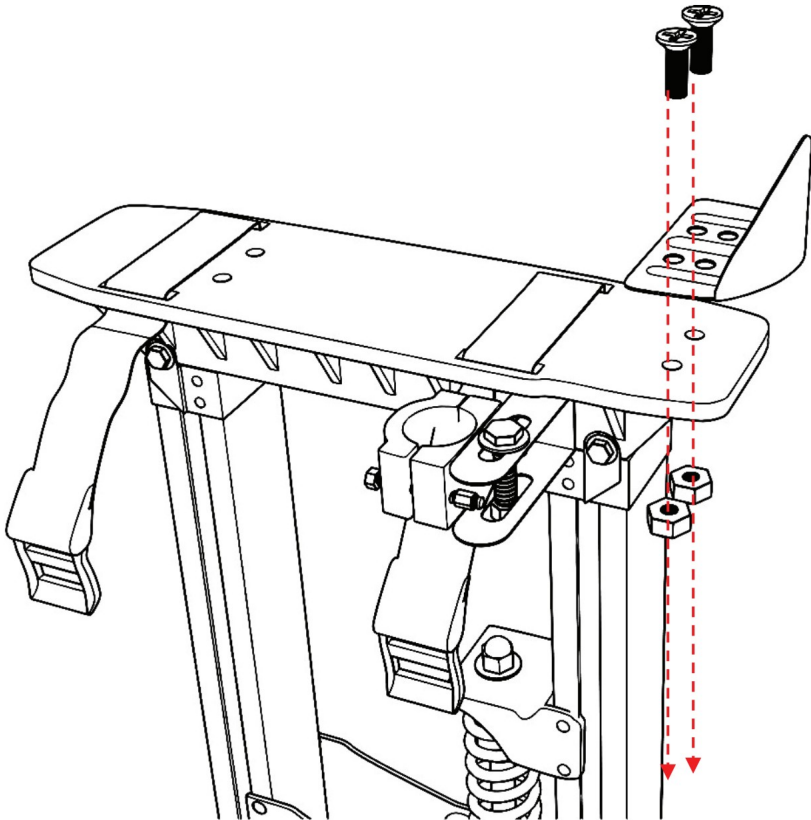

Install the heel bracket on the top of the stilt with two bolts and two nuts. Depending on the size of your feet, choose the front or back holes to install.

3



Use the straps on the stilt to secure your feet. Ensure that the straps are fastened tightly.

4

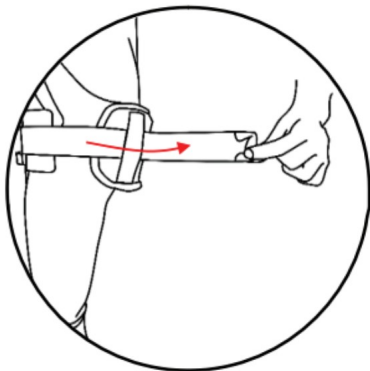

Thread the ends of the strap through the skid-proof rubber sole.



Thread the end of the strap through their buckles.

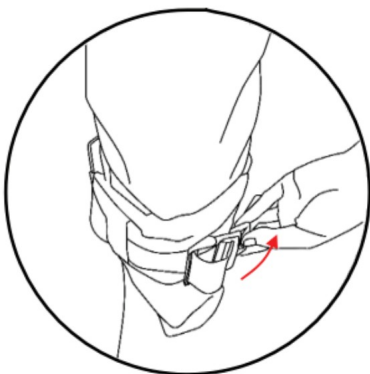
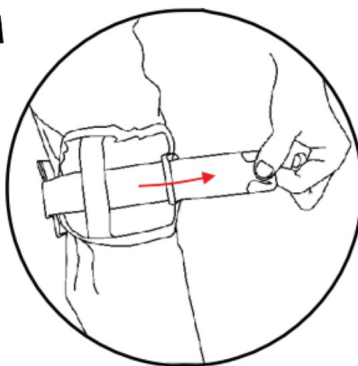

Fasten up the strap.

Ensure that the strap is fastened tightly and then the preparation is finished.

ADJUST THE STILT HEIGHT

NOTE:

Before adjusting the height of the stilts, take your feet off the stilts first.

1

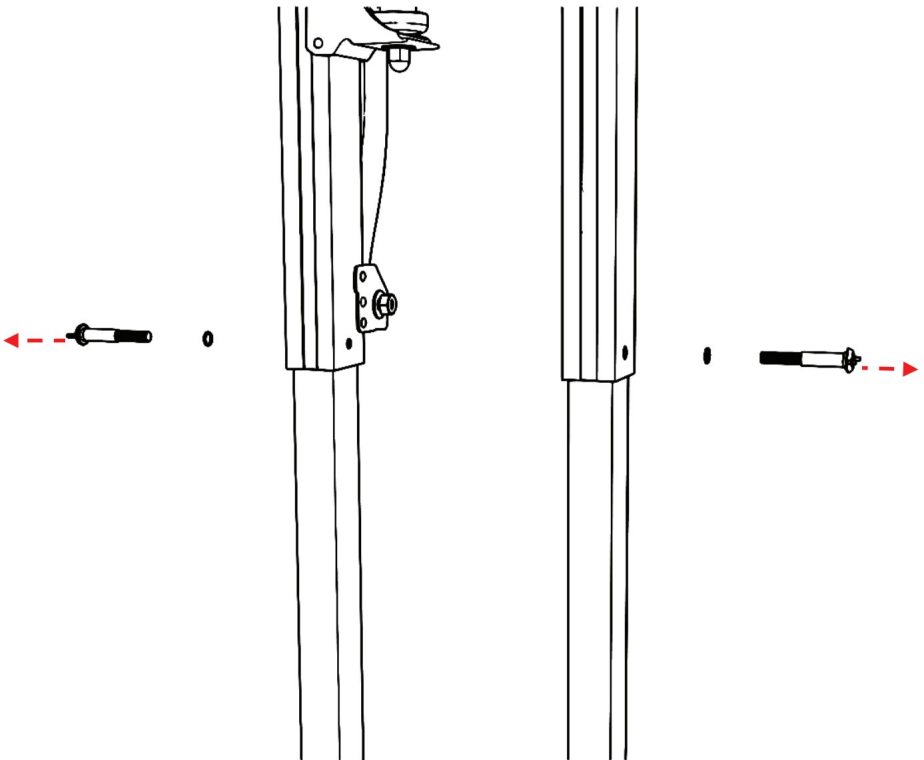

Loosen and separate the 4 bolts on the stilts.

2

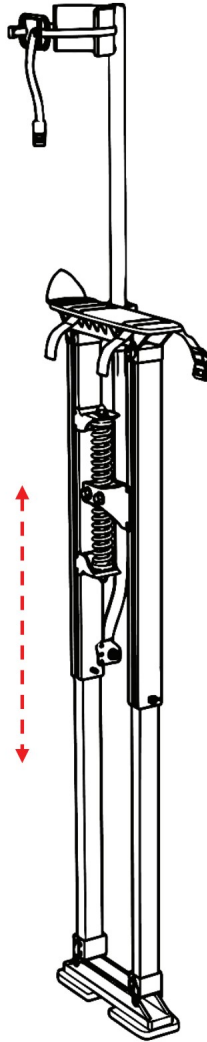

Adjust the height of the stilts. Ensure that the heights of both stilts are the same. After that, fasten the bolts.

Fabrikant: Shanghaimuxinmuyeyouxiangongsi Adres:
Shuangchenglu 803nong11hao1602A-1609shi, baoshanqu, shanghai 200000
CN.

Geïmporteerd naar AUS: SIHAO PTY LTD. 1 ROKEVA STREETEASTWOOD
NSW 2122 Australië

Geïmporteerd naar de VS: Sanven Technology Ltd. Suite 250, 9166 Anaheim Place,
Rancho Cucamonga, CA 91730



E-CrossStu GmbH
Mainzer Landstr.69,
60329 Frankfurt am Main.



YH CONSULTING LIMITED. C/O YH Consulting
Limited Kantoor 147, Centurion House, London
Road, Staines-upon-Thames, Surrey, TW18 4AX

VEVOR[®]

TOUGH TOOLS, HALF PRICE

Technical Support and E-Warranty Certificate

www.vevor.com/support

VEVOR[®]

TOUGH TOOLS, HALF PRICE

Technical Support and E-Warranty Certificate

www.vevor.com/support

DRYWALL STILTS USER MANUAL

We continue to be committed to provide you tools with competitive price.

"Save Half", "Half Price" or any other similar expressions used by us only represents an estimate of savings you might benefit from buying certain tools with us compared to the major top brands and does not necessarily mean to cover all categories of tools offered by us. You are kindly reminded to verify carefully when you are placing an order with us if you are actually saving half in comparison with the top major brands.

VEVOR[®]

DRYWALL STILTS USER MANUAL

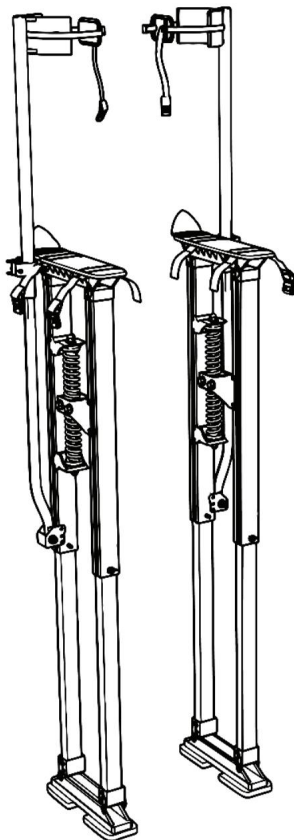

NEED HELP? CONTACT US!

Have product questions? Need technical support? Please feel free to contact us:

Teknisk support och e-garanticertifikat
www.vevor.com/support

This is the original instruction. Please read all manual instructions carefully before operating. VEVOR reserves a clear interpretation of our user manual. The appearance of the product shall be subject to the product you received. Please forgive us that we won't inform you again if there are any technology or software updates on our product.



Safety Instructions

1. Inspect the stilts thoroughly before use. Ensure that the parts are free of damage and that all the bolts and screws are fully tightened enough.
2. Use this product only on level and flat ground surfaces and there is no low profile furniture and other obstructions around.
3. When adjusting the height of the stilts, take them off your legs first for safety concerns.
4. Keep all straps fastened and secured before you walk on the stilts.
5. When walking on the stilts, never take a big step. Instead, make sure the stilts are raised well above the ground with each step.
6. Never use the stilts to walk on a slippery ground.
7. Never overload the stilts.
8. Walk slowly. Don't run or walk fast on the stilts.
9. Don't modify the stilts arbitrarily.
10. Don't walk on the stilts if you are influenced by alcohol or drugs.
11. Children are not allowed to use this product. Minors and seniors are not recommended to use this product.
12. Ensure the surrounding area is clean when using this product. Always wear protective gear (especially for the knee and elbow) and a helmet before using the product. It's recommended that the beginner uses two supporting sticks for balance.
13. It is forbidden to use this product on public roads or streets.
14. When using the product, it is recommended to wear anti-slip shoes.
15. The intended purpose of this product is for architectural decoration or ceiling repair. It is not for entertaining or dancing.
16. It's recommended to let the other 2 people assist the user stand on the stilts.

PACKAGE CONTENT

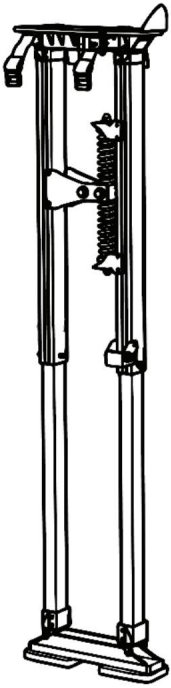

Skid-proof Rubber Sole x 2

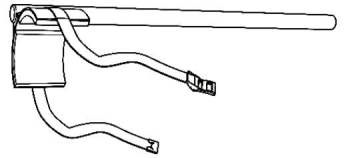

Metal Buckle x 2

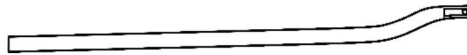

Supporting Stick x 2

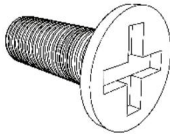

Bolt x 4

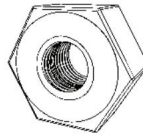

Nut x 4

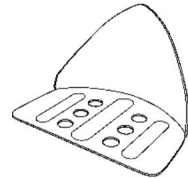

3-Position Heel Bracket x 2

SPECIFICATIONS

Modellserie	HCST-18SI	HCST-24SI	HCST-24BK	HCST-36SI
Övergripande mått (L x B x H)	32,5" x 10,8" x 5,3" (825x275x135 mm)	36,2" x 11" x 5,5" (920x280x140 mm)	36,2" x 11" x 5,5" (920x280x140 mm)	48" x 11" x 5,5" (1220x280x140 mm)
Viktkapacitet	228 lbs (103 kg)	228 lbs (103 kg)	228 lbs (103 kg)	228 lbs (103 kg)
Justerbar höjd	18" till 30" (457 till 762 mm)	24" till 40" (610 till 1016 mm)	24" till 40" (610 till 1016 mm)	36" till 50" (914 till 1267 mm)

ASSEMBLY INSTRUCTIONS

The assembly procedures of the two stilts are the same. Here we take one stilt as an example. You can follow the same steps to finish the assembly for the other stilt.

1

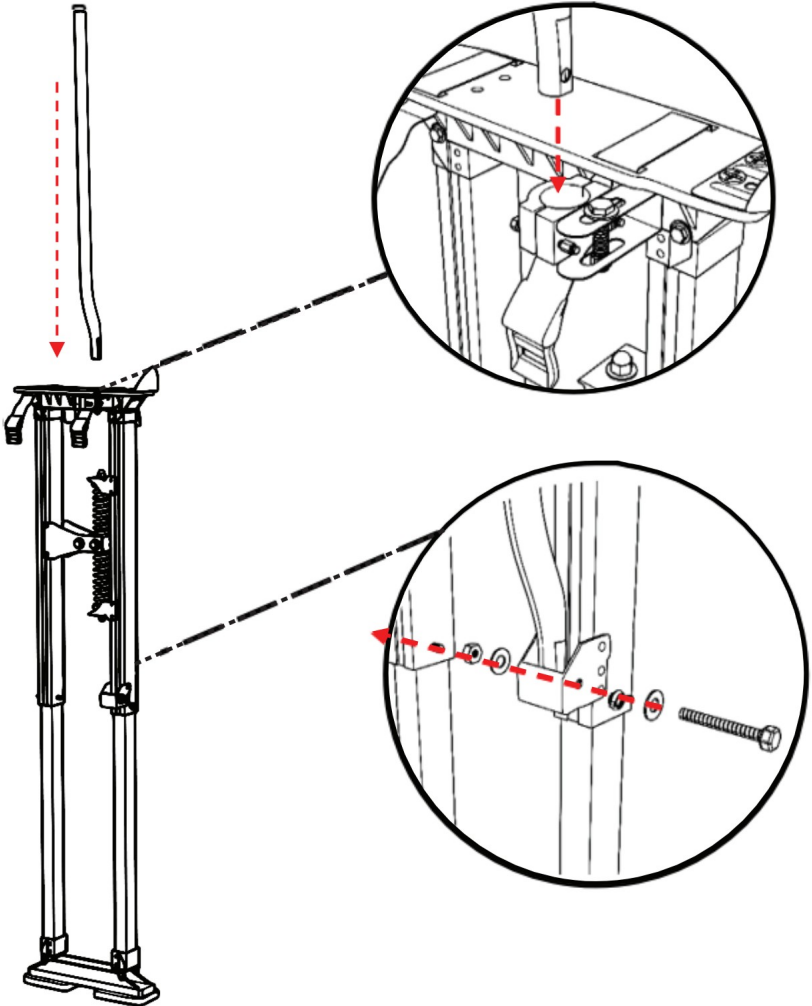

1. Insert the supporting stick through the side hole on the left stilt.
2. Secure the end of the supporting stick on the side bracket of the left stilt with the bolt and nut.
(The bolt and nut are preinstalled on the side bracket.)

2

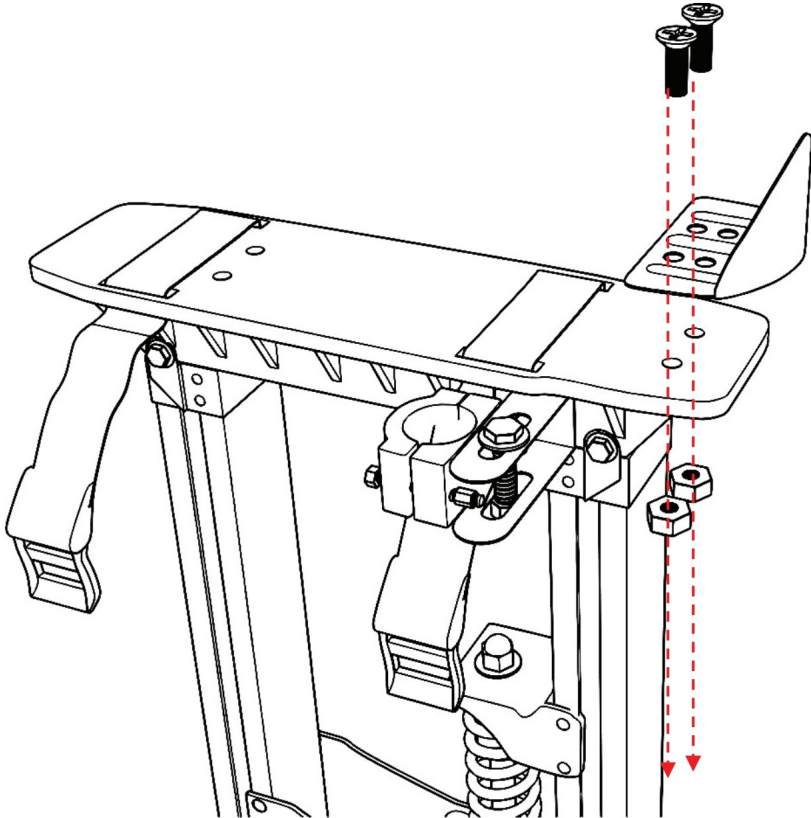

Install the heel bracket on the top of the stilt with two bolts and two nuts. Depending on the size of your feet, choose the front or back holes to install.

3



Use the straps on the stilt to secure your feet. Ensure that the straps are fastened tightly.

4

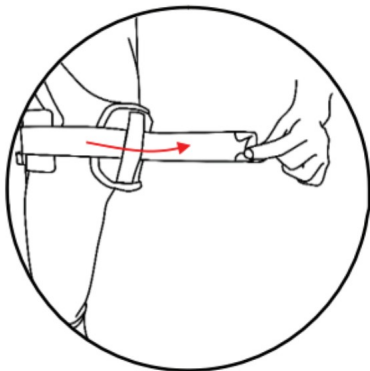

Thread the ends of the strap through the skid-proof rubber sole.



Thread the end of the strap through their buckles.

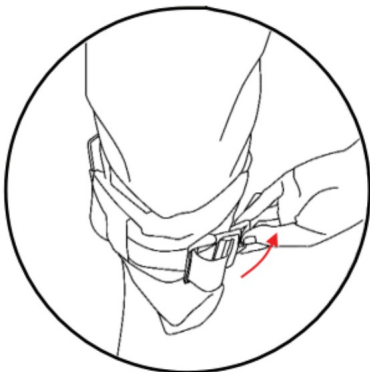
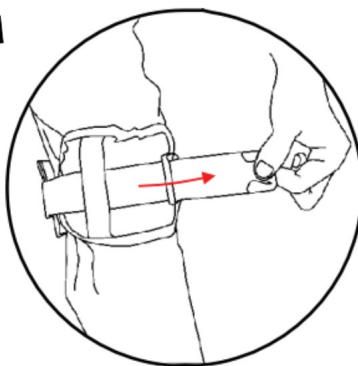

Fasten up the strap.

Ensure that the strap is fastened tightly and then the preparation is finished.

ADJUST THE STILT HEIGHT

NOTE:

Before adjusting the height of the stilts, take your feet off the stilts first.

1

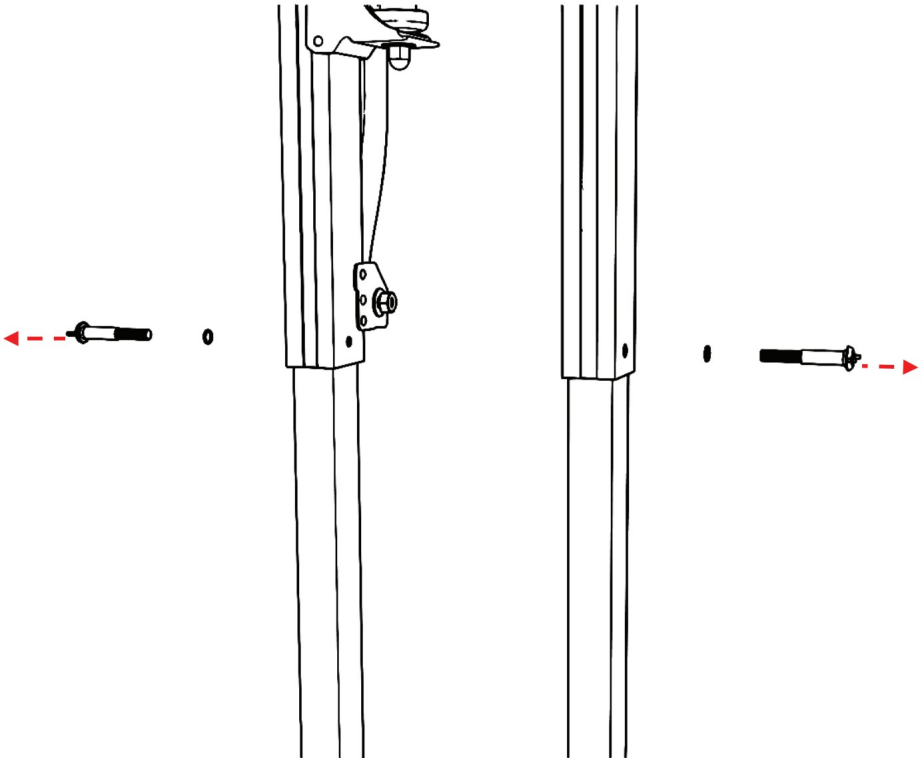

Loosen and separate the 4 bolts on the stilts.

2

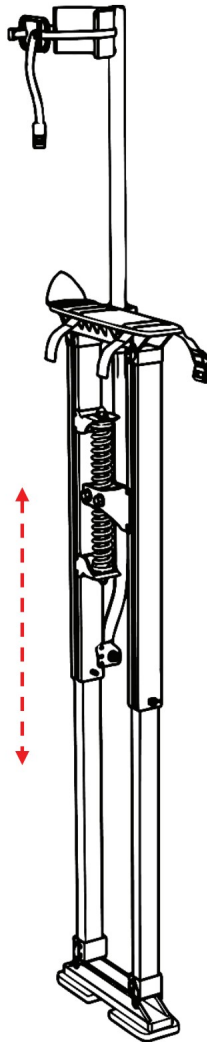

Adjust the height of the stilts. Ensure that the heights of both stilts are the same. After that, fasten the bolts.

Tillverkare: Shanghaimuxinmuyeyouxiangongsi

Adress: Shuangchenglu 803nong11hao1602A-1609shi, baoshanqu,
shanghai 200000 CN.

Importerad till AUS: SIHAO PTY LTD. 1 ROKEVA STREETEASTWOOD
NSW 2122 Australien

Importerad till USA: Sanven Technology Ltd. Suite 250, 9166 Anaheim Place,
Rancho Cucamonga, CA 91730



E-CrossStu GmbH
Mainzer Landstr.69,
60329 Frankfurt am Main.



YH CONSULTING LIMITED. C/O YH Consulting
Limited Office 147, Centurion House, London
Road, Staines-upon-Thames, Surrey, TW18 4AX

VEVOR[®]

TOUGH TOOLS, HALF PRICE

Technical Support and E-Warranty Certificate

www.vevor.com/support