

3kW5.12kWh
Vertical wall-mounted
all-in-one machine

USER INSTRUCTION

This All in one energy storage is one of a series of industrial energy storage products designed and developed independently. Long cycle life, high safety standard BMS software protection, sturdy shell, beautiful appearance, easy installation and use, etc. Widely used in various energy storage systems.

Catalogue

(Revision History)	3
1. Symbol Description	4
2. Safety Precautions	5
2.1 Before Connecting	5
2.2 In Using	5
3. Introduction	6
3.1 Features	6
3.2 Functions	7
3.3 Specification Parameters	8
3.4 Equipment interface instruction	8
3.5 LCD Display Icons	11
3.6 LCD Setting	13
3.7 Fault Reference Code	18
3.8 Warning Indicator	19
3.9 Operating State Description	20
3.10 Display Setting	21
4. Safe Handling of Lithium-iron ESS Batteries Guide	21
4.1 Solution Diagram	21
4.2 Danger Label	22
4.3 Tool	22
4.4 Safety Gear	22
5. Installation and operation	22
5.1 Installation Location	22
5.2 System turns on	23
5.3 System turns off	23
6. Emergency Situations	23
6.1 Battery Leakage	23
6.2 On Fire	23
6.3 Wet Batteries	23
6.4 Damaged Batteries	24
7. Remarks	24

7.1 Maintenance 24











Parts List **24**

Maintenance Record **25**

(Revision History)

Ver.No.	Date	Revised Content	Reasons for Change	Reviser	Approve
A0	2024.12.16	First Edition	First Draft	haote.Feng	

1. Symbol Description

	Do not place near open fire or flammable materials.
	A potential hazard exists when the equipment is working. Wear personal protective equipment during operation.
	Warning electric shock. Power off the equipment before any operation.
	Grounding: indicate PE cable connection position.
	Do not place in areas accessible to children.
	Keep the battery away from open fire or ignition sources.
	Read the product and operation manual before operating the battery system.
	Label for Waste Electrical and Electronic Equipment (WEEE) Directive (2012/19/EU).
	The certificate label for CE.
	Recycle label.

2. Safety Precautions



Alert

- 1) It is important and necessary to read the user manual carefully (and attachment) before installing or using battery. Failure to do so or to follow any instruction or warning in this document can result in electrical shock, serious injury, and death, or damage battery, potentially rendering it unusable.
- 2) When battery is stored for a long time, it is required to charge once every 6 months, and the SOC should be no less than 50%.
- 3) After battery module cannot be discharged, it needs to be recharged within 12h.
- 4) Do not connect power terminal reversely.
- 5) All power supplies must be disconnected during maintenance.
- 6) Please contact the supplier within 24 hours if there is something abnormal.
- 7) Do not use any liquid to clean the battery.
- 8) Do not expose battery to flammable or irritating chemicals or vapor.
- 9) Do not paint any part of battery, including any internal or external components.
- 10) Do not connect battery with PV solar wiring directly.
- 11) Do not install or use this product beyond provisions of the manual.
- 12) Direct or indirect damages caused by the above reasons are not covered by warranty claim.



Warning

2.1 Before Connecting

- 1) Please check the external packaging condition before unpacking. If it is damaged, contact corresponding local retailer.
- 2) After unpacking, please check the products and spare parts according to spare parts list. If the product is damaged or missing, please contact your local retailer.
- 3) Before installation, be sure to cut off the grid power and make sure battery switch is on OFF mode.
- 4) It is prohibited to connect the battery and AC power directly.
- 5) All electrical wiring must be connected in accordance with local regulations.
- 6) Please ensure that electrical performance of battery system is compatible with the equipment.
- 7) The installation onsite shall be equipped with fire-fighting facilities that meet relevant requirements, such as fire sand, dry powder fire extinguisher, etc.

2.2 In Using

- 1) If battery system needs to be moved or repaired, power must be cut off and battery is completely shut down.

- 2) It is prohibited to connect battery with different types of battery.
- 3) Do not connect battery to faulty inverter.
- 4) Except for personnel from The Company or other authorized personnel, batteries shall not be opened, repaired or disassembled. The company shall not bear any liability or responsibility caused by violation of any safety operation or design standard, production standard, equipment safety standards or any other standards or requirements.

3.Introduction

This power lifepo4 lithium battery is a new energy storage product developed and produced by The Company, which can provide reliable power supply for all kinds of equipment or systems.

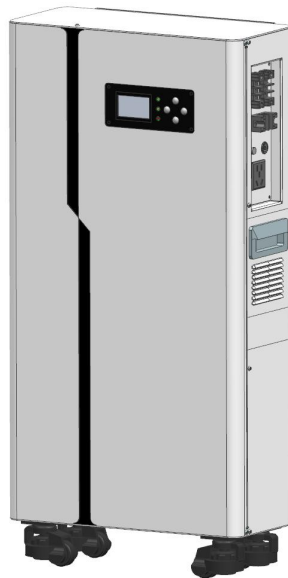

Figure 3-1

3.1 Features

- 1) The module is non-toxic, non-polluting and environmentally friendly.
- 2) Cathode material is made from LiFePO₄ with safety performance and long cycle life.
- 3) Battery management system (BMS) has protection functions including over- discharge, over-charge, over-current and high/low temperature.
- 4) The system can automatically manage charge and discharge state and balance voltage of each cell.
- 5) Adopted self-cooling mode rapidly reduced system entire noise.
- 6) The module has less self-discharge, up to 6 months without charging it on shelf, no memory effect, excellent performance of shallow charge and discharge.
- 7) Multi-functional LED intelligent digital screen display.

3.2 Functions

Protection and Alarm	Management and monitor
Charge/Discharge End	Cell Balance
Over voltage Charging Protection	Intelligent Charge Model
Under Voltage Discharging Protection	Charge/Discharge Current Limit
Charge/Discharge Over current Protection	Capacity Retention Calculate
High/Low Temperature Protection	Short Circuit Protection
History Record	Adjustable parameter settings

Items	Specification
Product Name	3kW5.12Kwh All in one energy storage
Battery parameters	
Module Model	25.6V200Ah
Battery Type	LFP 2P8S
Nominal Capacity	5.12 kWh
Nominal Voltage	25.6V
Working Voltage	21.6-28V
VSOLAR CHARGER	
Maximum PV Array Open Circuit Voltage	160VDC
PV Array MPPT Voltage Range(TYP.)	30~128VDC
Maximum PV Array Power	1600W
Maximum Solar Charge Current	60A
Maximum AC Charge Current	60A
AC INPUT	
Voltage	230VAC
Selectable Voltage Range	170~280VAC(UPS) / 90~280VAC(APL) / 184~253VAC(VDE)
Frequency Range	50Hz / 60Hz (Auto sensing)
AC Output	
Rated Power	3200W
AC Voltage Regulation	220~240Vac
Inverter Efficiency	90%~93%
Overall parameters	
Communication	RS485 ,WiFi
Storage Temperature	-20°C ~ 55°C (Recommended)
Working Humidity	≤95% (RH) No Condensation
Working Temperature	0°C ~ 55°C
Working Altitude	≤2000m
Cooling method	natural cooling
Installation method	Wall-hung/On floor
Protective Class	IP20
Weight	~72kg
Dimension	500mm*1025mm*195mm
Design Life	10 Years (25°C)
Cycle Life	> 6000 (25°C) ,80% DOD

3.3 Specification Parameters

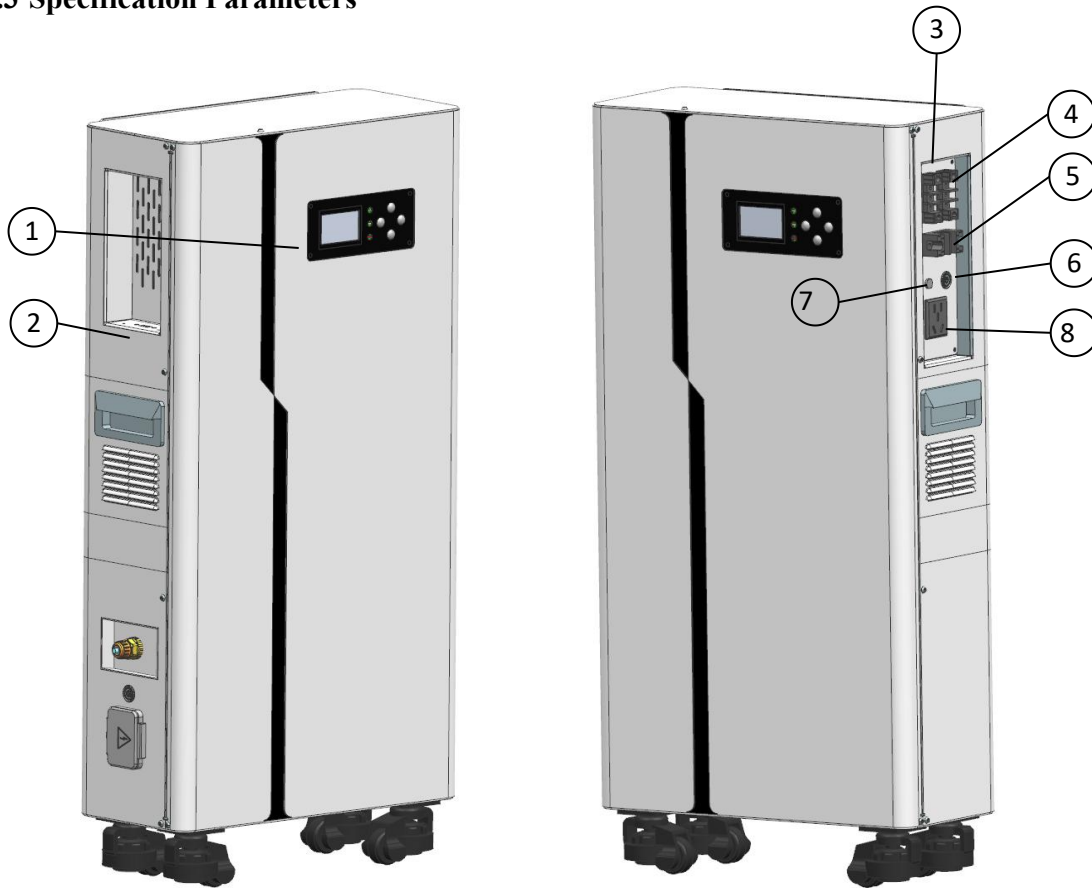

3.4 Equipment interface instruction

- ① **Operation panel: LCD display, Status indicator, Function Keys**
- ② **USB: WiFi**
- ③ **AC IN : AC input terminal**
- ④ **AC OUT: AC output terminal**
- ⑤ **PV:PV charging interface**
- ⑥ **Start: switch**
- ⑦ **OCP: AC input overload protection**
- ⑧ **AC OUT:Power socket**

➤ Operation panel

The operation and display panel, shown in below chart, is on the front panel of the inverter. It includes three indicators, four function keys and a LCD display, indicating the operating status and input/output power information,

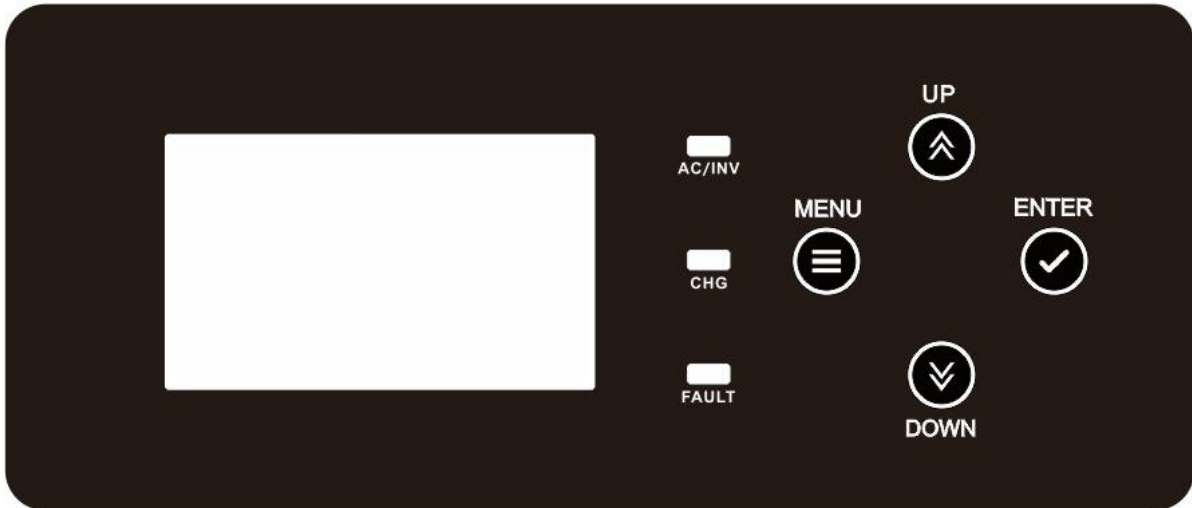

LED Indicator			Messages
AC/IN V	Green	Solid On	Output is powered by grid in line mode.
		Flashing	Output is powered by battery or PV in battery mode.
CHG	Yellow	Flashing	Battery is charging or discharging.
FAULT	Red	Solid On	Fault occurs in the inverter.
		Flashing	Warning condition occurs in the inverter.

Function Keys	Description
MENU	Enter reset mode or setting mode go to previous selection.
UP	Increase the setting data.
DOWN	Decrease the setting date.
ENTER	Enter setting mode and Confirm the selection in setting mode go to next selection or exit the reset mode.

➤ Start

When the battery is dormant, pressing the start button will open the battery module and inverter module.

Attention:

It is strictly prohibited to turn off the circuit start switch first when the inverter is charging and discharging the battery.

➤ **AC OUT**

The device has two AC output sockets, a 3P wall terminal (30A), and a five pin socket (10A). Do not use electrical appliances other than the power indicated on the device. Air conditioning and other electrical appliances need at least 2-3 minutes to restart, as they require sufficient time to balance the refrigerant gas in the circuit. If there is a power shortage and it is restored in a short period of time, it will cause damage to the connected devices. To prevent such damage, please check if the air conditioner has a delay function before installation and check the manufacturer. Otherwise, this inverter/charger will trigger an overload fault and cut off the output to protect your device, but sometimes it can still cause internal damage to the air conditioner.

➤ **OCP**

An overload protection switch for the AC charging socket. If it is overloaded, the protection switch button will automatically pop up and you need to wait for 30 seconds before manually pressing the switch back.

➤ **AC IN**

Before connecting the AC input power, please install a separate AC circuit breaker between this device and the AC input power. This will ensure that the inverter can be safely disconnected during maintenance and fully protect it from the impact of AC input over current. The recommended specification for AC circuit breakers is 32A, suitable for 3KW.



Warning

All wiring must be operated by professional personnel.

The use of appropriate cables for AC input connections is crucial for the safe and efficient operation of the system. To reduce the risk of injury, please use a 12AWG cable for connection.

➤ **PV**

Before connecting PV components, please install a separate DC circuit breaker between this device and the photovoltaic system.



Warning

All wiring must be operated by professional personnel.

The use of appropriate cables to connect PV components is crucial for the safe and efficient operation of the system. To reduce the risk of injury, please use 8AWG cable to connect.

3.5 LCD Display Icons

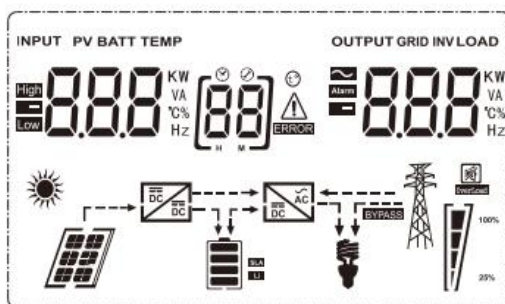

Icon	Function description	
Input Source Information and Output Information		
	Indicates the AC information.	
	Indicates the DC information.	
	Indicate input voltage, input frequency, PV voltage, battery voltage and charger current. Indicate output voltage, output frequency, load in VA, load in Watt and discharging current.	
Configuration Program and Fault Information		
	Indicates the setting programs.	
	Indicates the warning and fault codes. Warning: flashing with warning code. Fault: lighting with fault code.	
Battery Information		
	Indicates battery level by 0-24%, 25-49%, 50-74% and 75-100% in battery mode and charging status in line mode.	
In AC mode, it will present battery charging status.		
Status	Battery voltage	LCD Display
Constant Current mode / Constant Voltage mode	<2V/cell	4 bars will flash in turns.
	2 ~ 2.083V/cell	Bottom bar will be on and the other three bars will flash in turns.
	2.083 ~ 2.167V/cell	Bottom two bars will be on and the other two bars will flash in turns.
	> 2.167 V/cell	Bottom three bars will be on and the top bar will flash.
Batteries are fully charged.		4 bars will be on.

In battery mode, it will present battery capacity.				
Load Percentage	Battery Voltage	LCD Display		
Load > 50%	< 1.717V/cell			
	1.717V/cell ~ 1.8V/cell			
	1.8 ~ 1.883V/cell			
	> 1.883 V/cell			
50% > Load > 20%	< 1.817V/cell			
	1.817V/cell ~ 1.9V/cell			
	1.9 ~ 1.983V/cell			
	> 1.983V/cell			
Load < 20%	< 1.867V/cell			
	1.867V/cell ~ 1.95V/cell			
	1.95 ~ 2.033V/cell			
	> 2.033V/cell			
Load Information				
	Indicates overload.			
	Indicates the load level by 0-24%, 25-49%, 50-74% and 75-100%.			
	0%~24%	25%~49%	50%~74%	75%~100%
Mode Operation Information				
	Indicates unit connected to the mains.			
	Indicates unit connected to the PV panel.			
	Indicates load is supplied by utility power.			
	Indicates the solar charger is working.			
	Indicates the DC/AC inverter circuit is working.			
Mute Operation				
	Indicates unit alarm is disabled.			

3.6 LCD Setting

After pressing and holding "ENTER" button for 2 seconds, the unit will enter setting mode. Press "UP" or "DOWN" button to select setting programs. And then, press "ENTER" or "MENU" button to confirm the selection and exit.

Setting Programs:

Program	Description	Selectable option
00	Exit setting mode	Escape [00] ESC
01	Output source priority selection	[01] SBU Solar energy provides power to the loads as first priority. If battery voltage has been higher than the setting point in program 21 for 5 minutes, the inverter will turn to battery mode, solar and battery will provide power to the load at the same time. When the battery voltage drops to the setting point in program 20, the inverter will turn to bypass mode, utility provides power to the load only, and the solar will charge the battery at the same time.
		[01] SOL Solar energy provides power to the loads as first priority. If battery voltage has been higher than the setting point in program 21 for 5 minutes, and the solar energy has been available for 5 minutes too, the inverter will turn to battery mode, solar and battery will provide power to the load at the same time. When the battery voltage drops to the setting point in program 20, the inverter will turn to bypass mode, utility provides power to the load only, and the solar will charge the battery at the same time.
		(default) [01] UT Utility will provide power to the loads as first priority. Solar and battery energy will provide power to the loads only when utility power is not available.

02	AC input voltage range	Appliances (default) [02] APL	If selected, acceptable AC input voltage range will be within 90-280VAC.
		UPS [02] UPS	If selected, acceptable AC input voltage range will be within 170-280VAC.
		VDE [02] VDE	If selected, acceptable AC input voltage range will conform to VDE4105(184VAC-253VAC).
		GEN [02] GEN	When the user uses the device to connect the generator, select the generator mode.
03	Output voltage	[03] 230 _v	Set the output voltage amplitude, (220VAC-240VAC).
04	Output frequency	50HZ(default) [04] 500	60HZ [04] 600
		[05] BLU	Solar energy provides power to charge battery as first priority.
05	Solar supply priority	(default) [05] LBU	Solar energy provides power to the loads as first priority.
		Bypass disable [06] BYD	Bypass enable (default) [06] BYE
06	Overload bypass: When enabled, the unit will transfer to line mode if overload occurs in battery mode.	Restart disable (default) [07] LTD	Restart enable [07] LTE
07	Auto restart when overload occurs	Restart disable (default) [08] LTD	Restart enable [08] LTE
08	Auto restart when over temperature occurs	Restart disable (default) [08] LTD	Restart enable [08] LTE
10	Charger source priority: To configure charger source priority	If this inverter/charger is working in Line, Standby or Fault mode, charger source can be programmed as below:	
		Solar first [10] CSO	Solar energy will charge battery as first priority. Utility will charge battery only when solar energy is not available.
		Solar and Utility (default) [10] SNU	Solar energy and utility will charge battery at the same time.

		Only Solar [10] 050	Solar energy will be the only charger source no matter utility is available or not.
		If this inverter/charger is working in Battery mode or Power saving mode, only solar energy can charge battery. Solar energy will charge battery if it's available and sufficient.	
11	Maximum solar charging current (Max. charging current=utility charging current +solar charging current)	2-3KW 60A (default) [11] 60 ^A	Setting range is from 1 A to 60A. Increment of each click is 1A.
13	Maximum utility charging current (Max. charging current= utility charging current + solar charging current)	2KW	40A(Maximum current) Setting range is from 1 A to 40A. Increment of each click is 1A.
		40A (default) [13] 40 ^A	
		3KW	60A(Maximum current) Setting range is from 1 A to 60A. Increment of each click is 1A.
		60A (default) [13] 60 ^A	
14	Battery type	AGM (default) [14] AGM	Flooded [14] FLD
		GEL [14] GEL	LEAD [14] LEA
		Lithium Ion [14] LI	User-Defined [14] USE
		If "User-Defined" LI is selected, battery charge voltage and low DC cut-off voltage can be set up in program 17, 18 and 19.	
17	Bulk charging voltage (C.V voltage)	default setting: 28.2V [17] CV 28.2 ^v	If "User-Defined" LI is selected in program 14, this program can be set up. Setting range is from 24.0V to 29.2V. Increment of each click is 0.1V.
18	Floating charging voltage	default setting: 27.0V [18] FLV 27.0 ^v	If "User-Defined" LI is selected in program 14, this program can be set up, Setting range is from 24.0V to 29.2V. Increment of each click is 0.1V.



















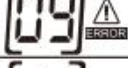



19	Low DC cut off battery voltage setting	default setting: 20.4V [19] 20.4 ^v	
		If "User-Defined" LI is selected in program 14, this program can be set up. Setting range is from 20.0V to 24.0V. Increment of each click is 0.1V. Low DC cut-off voltage will be fixed to setting value no matter what percentage of load is connected.	
20	Battery stop discharging voltage when grid is available	23V (default) [20] 23.0 ^v	Setting range is from 22.0V to 29.0V. Increment of each click is 0.1V.
21	Battery stop charging voltage when grid is available	27.0V (default) [21] 27.0 ^v	Setting range is from 22.0V to 29.0V. Increment of each click is 0.1V.
22	Auto turn page	(default) [22] PLE	If selected, the display screen will auto turn the display page.
		[22] PLd	If selected, the display screen will stay at latest screen user finally switches.
23	Backlight control	Backlight on [23] LON	Backlight off(default) [23] LOF
		Alarm on (default) [24] BON	Alarm off [24] BOF
24	Alarm control	Alarm on (default) [24] BON	Alarm off [24] BOF
25	Beeps while primary source is interrupted	Alarm on [25] AON	Alarm off (default) [25] AOF
27	Record Fault code	Record enable (default) [27] FON	Record disable [27] FOF
		Solar power balance enable [28] S6E	If selected, the solar input power will be automatically adjusted according to the following formula: Max. Input solar power = Max. battery charging power + Connected load power when the machine in OffGrid workstate.
28	Solar power balance: When enabled, solar input power will be automatically adjusted according to connected load power.	Solar power balance disable (default) [28] S6d	If selected, the solar input power will be the same to max. Battery charging power no matter how much loads are connected. The max.battery charging power will be based on the setting current in program 11 (Max. solar power = Max.battery charging power).









30	Battery equalization	Battery equalization [30] EEN	Battery equalization disable(default) [30] Ed5
31	Battery equalization voltage	default setting:28.8V [31] E4	28.8 ^v
Setting range is from 24.0V to 29.2V. Increment of each click is 0.1V.			
33	Battery equalization time	60min(default) [33] 60	Setting range is from 5 min to 900min. Increment of each click is 5min.
34	Battery equalization timeout	120min(default) [34] 120	Setting range is from 5 min to 900min. Increment of each click is 5min.
35	Equalization interval	30days(default) [35] 30d	Setting range is from 0 to 90days. Increment of each click is 1 day.
36	Equalization activated immediately	Enable [36] AEN	Disable(default) [36] Ad5
If equalization function is enabled in program 30, this program can be set up. If "Enable" is selected in this program, it's to activate battery equalization immediately and LCD main page will shows "EQ ". If "Disable" is selected, it will cancel equalization function until next activated equalization time arrives based on program 35 setting. At this time, "EQ " will be shown in LCD main page too.			

After pressing and holding "MENU" button for 6 seconds, the unit will enter reset model. Press "Up" and "DOWN" button to select programs. And then ,press "ENTER" button to exit.













SET	(default) [dt] nrt	Reset setting disable.
	[dt] t5t	Reset setting enable.

3.7 Fault Reference Code





Fault Code	Fault Event	Icon on
01	Fan is locked when inverter is off	
02	Inverter transformer over temperature	
03	Battery voltage is too high	
04	Battery voltage is too low	
05	Output short circuited	
06	Inverter output voltage is high	
07	Overload time out	
08	Inverter bus voltage is too high	
09	Bus soft start failed	
11	Main relay failed	
21	Inverter output voltage sensor error	
22	Inverter grid voltage sensor error	
23	Inverter output current sensor error	
24	Inverter grid current sensor error	
25	Inverter load current sensor error	
26	Inverter grid over current error	
27	Inverter radiator over temperature	
31	Solar charger battery voltage class error	
32	Solar charger current sensor error	
33	Solar charger current is uncontrollable	
41	Inverter grid voltage is low	
42	Inverter grid voltage is high	

43	Inverter grid under frequency	
44	Inverter grid over frequency	
51	Inverter over current protection error	
52	Inverter bus voltage is too low or component temperature is to high	
53	Inverter soft start failed	
55	Over DC voltage in AC output	
56	Battery connection is open	
57	Inverter control current sensor error	
58	Inverter output voltage is too low	

3.8 Warning Indicator

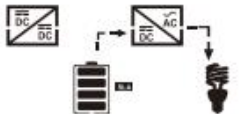
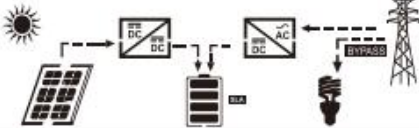
Fault Code	Fault Event	Icon on
61	Fan is locked when inverter is on.	
62	Fan 2 is locked when inverter is on.	
63	Battery is over-charged.	
64	Low battery.	
67	Overload.	
70	Output power derating.	
72	Solar charger stops due to low battery.	
73	Solar charger stops due to high PV voltage.	
74	Solar charger stops due to over load.	
75	Solar charger over temperature.	
76	PV charger communication error.	
77	Parameter error.	

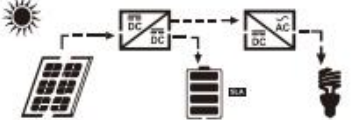
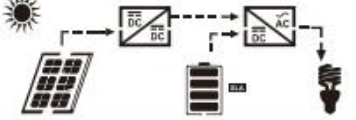
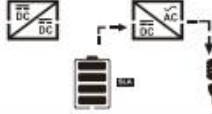
3.9 Operating State Description

Operation state	Description	LCD display
Utility-Tie state	PV energy is charger into the battery and utility provide power to the AC load.	PV is on 
		PV is off 
Charge state	PV energy and grid can charge batteries.	
Bypass state	Error are caused by inside circuit error or external reasons such as over temperature, output short circuited and so on.	
Off-Grid state	The inverter will provide output power from battery and PV power.	Inverter power loads from PV energy 
		Inverter power loads from battery and PV energy 
		Inverter power loads from battery only 
Stop mode	The inverter stop working if you turn off the inverter by the soft key or error has occurred in the condition of no grid.	

3.10 Display Setting

The LCD display information will be switched in turns by pressing "UP" or "DOWN" key. The selectable information is switched as below order: battery voltage, battery current ,inverter voltage, inverter current, grid voltage, grid current, load in Watt, load in VA, grid frequency, inverter frequency, PV voltage, PV charging power, PV charging output voltage, PV charging current.

Selectable information	LCD display	
Battery voltage/DC discharging current	^{BATT} 26.0 V	48.0 A
Inverter output voltage/Inverter output current	229 V	^{INV} 6.70 A
Grid voltage/Grid current	229 V	-3.0 A
Load in Watt/VA	150 KW	^{LOAD} 168 VA
Grid frequency/Inverter frequency	^{INPUT} 50.0 Hz	^{INV} 50.0 Hz
PV voltage and power	^{PV} 6.10 V	1.00 KW
PV charger output voltage and MPPT charging current	^{PV} 25.0 V	^{OUTPUT} 4.00 A

4. Safe Handling of Lithium-iron ESS Batteries Guide

4.1 Solution Diagram

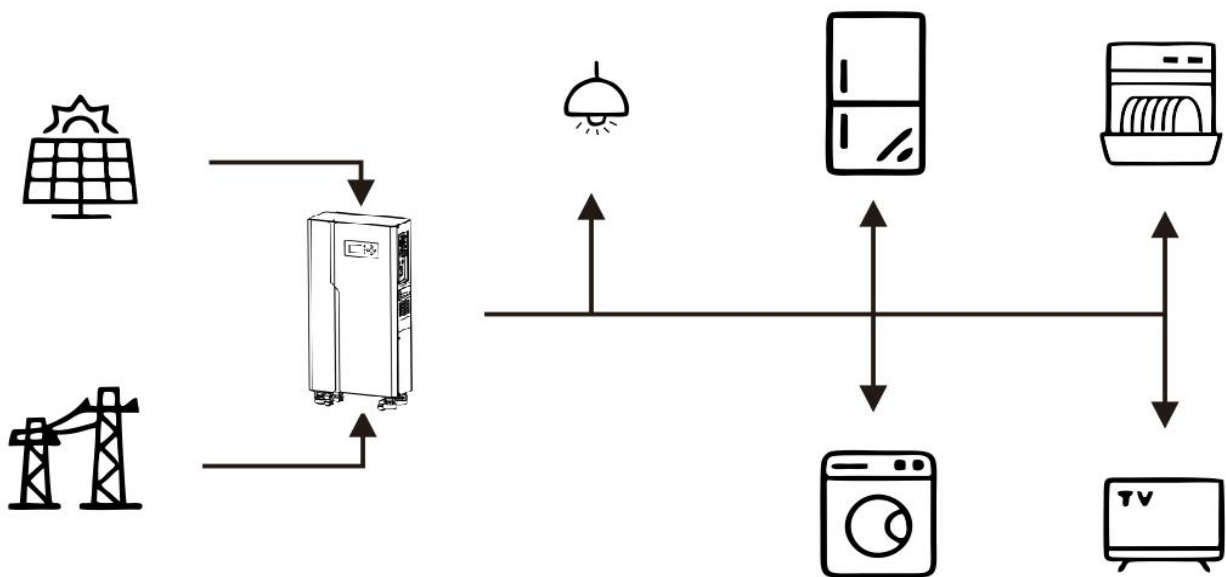



Figure 4-1

4.2 Danger Label

DANGER
DANGER LOW DCVOLTAGE INSIDE
DANGER ARC FLASH & SHOCK HAZARD



- * Do not disconnect or disassemble by non-professional personnel.
- * Do not drop, deform, impact, cut or spearing with a sharp object.
- * Do not place near open flame or flammable material.
- * Do not cover or wrap the product case.
- * Do not touch the leaking liquid.
- * Beware of high temperature.
- * Avoid of direct sunlight.
- * Follow the product manual to make wiring connection.
- * If leaking, fire, wet or damaged, switch off the breaker on DC side and stay away from battery.
- * Contact your supplier within 24 hours if anything failure happens.

Figure 4-2

4.3 Tool



Wire Cutter



Modular Crimping Pliers



Screwdriver



Electric drill

Note :

Properly use insulated tools to prevent accidental electric shock or short circuits. If tools are not insulated, cover the entire exposed metal surfaces of available tools with electrical tape except their tips.

4.4 Safety Gear

It is recommended to wear the following safety gear when dealing with battery pack.



Insulated Gloves



Safety Goggles



Safety Shoes

5. Installation and operation

5.1 Installation Location

Make sure that installation location should meet the following condition:

- 1) The area should be completely water-proof.
- 2) The floor should be flat and level.
- 3) No flammable or explosive materials.
- 4) The ambient temperature is within the range from 0°C to 50°C.

- 5) The temperature and humidity are maintained at a constant level.
- 6) There is just a little dust and dirt in the area.
- 7) The distance from heat source should be more than 2 meters.
- 8) The distance between the air outlet of this device and the obstruction is greater than 0.5 meters.
- 9) This device should avoid direct sunlight as much as possible.
- 10) No forced ventilation requirement for battery module, but please avoid installing in a closed area.

5.2 System turns on



Warning: Double check all the power cables and communication cables. Check all the power switches are OFF.

System turns on step:

- 1) Check all cables are connected correctly. Check grounding is connected.
- 2) If necessary, turn on the switch at battery. If possible, turn on AC or PV power source to wake up inverter.
- 3) If no alarm, the battery system will be ready for charging and discharge with PCS.

5.3 System turns off

When failure or before service, must turn the battery storage system off:

- 1) Turn off the power supply of electrical appliances.
- 2) Turn off the battery button switch.
- 3) Remove the connecting cable between the battery and the electrical appliance.

6. Emergency Situations

6.1 Battery Leakage

If the battery pack leaks electrolyte, avoid contact with the leaking liquid or gas. If one is exposed to the leaked substance, immediately perform the actions described below.

- 1) Inhalation: Evacuate contaminated area and seek medical aid.
- 2) Contact with eyes: Rinse eyes with flowing water for 15 minutes and seek medical aid.
- 3) Contact with skin: Wash affected area thoroughly with soap water and seek medical aid.

Ingestion: Induce vomiting and seek medical aid.

6.2 On Fire

NO WATER!

Only dry powder fire or carbon dioxide extinguisher can be used; if possible, move the battery module to a safe area before it catches fire.

6.3 Wet Batteries

If the module is wet or submerged in water, do not let people access it, then contact us or an authorized dealer for technical support. Cut off all power switch.

6.4 Damaged Batteries

Damaged batteries are dangerous and must be handled with utmost care. They are not fit for use and may pose a danger to people or property. If the module seems to be damaged, pack it in its original container, then return it to authorized dealer.



Warning

Damaged batteries may leak electrolyte or produce flammable gas.

7. Remarks

7.1 Maintenance

Check installation environment such as dust, water, insect etc. Make sure it is suitable for IP20 battery system. Connection of power connector, grounding point, power cable and screw are suggested to be checked every year.

Parts List

Item	Part Name	Description	Unit	Quantity
1	All in one energy storage	3kW2.5kWh	PCS	1
3	Instructions		PCS	1
4	Certificate		PCS	1
5	grounding wire	A 1.5-meter grounding wire of No.12	PCS	1

Maintenance Record

Dear user, thank you for selecting our product, please fill in and keep the warranty card for better services.

Attn: _____ Product No.: _____

Tel: _____ E-mail: _____

Purchase Date: _____

Address: _____

Maintenance Record			
Date of repair	Content	Maintenance Personnel	Note