

Helmet Smart HUD User Manual

MOTOEYE E6/E6-SE

Xi'an Vidoar Technologies Co., Ltd.

www.vidoar.com

2023. 12. 28

CONTENTS

I. Product introduction.....	1
1. Brief introduction.....	1
2. Product parameters.....	4
3. Features.....	5
4. Differences between E6 and E6-SE.....	20
5. APP download.....	22
II. E6/E6-SE Installation.....	23
1. Packing list.....	23
2. Appearance description.....	24
3. Install HUD host.....	24
4. Install display module.....	26
5. Install headset.....	28
6. Install TF card.....	29
7. Storage cable.....	29
8. Install remote controller.....	29
9. Definition of key.....	31
10. Definition of LEDs.....	31
III. E6/E6-SE using manual.....	32
1. Power on/off.....	32
2. Charging.....	32
3. Volume control.....	32
4. Connection between MOTOEYE APP and HUD host.....	32
5. WiFi Connection.....	34
6. Share mobile network through bluetooth.....	36
7. Connect to Bluetooth controller.....	37
8. Connect to walkie-talkie.....	38
9. Setting of UI style.....	39
10. Navigation.....	43
12. Make and answer a call.....	45
13. Music.....	48
14. Take a photo.....	49
15. Driving Record.....	49
16. Voice command.....	51
17. Photo and video download.....	53
18. Public network intercom.....	55
19. Mesh intercom.....	57
20. Apple CarPlay.....	59
21. Huawei HiCar.....	62
22. Android Auto.....	65
23. Mobile screen mirroring.....	68

24. Light effect settings.....	71
25. HUD settings.....	73
26. Restore factory setting.....	75
27. TF card formatting and file management.....	76
28. Firmware upgrade.....	78
IV. Remote controller usage.....	79
1. Install remote controller.....	79
2. Replace the battery.....	80
3. Pairing and connection.....	80
V. Safety tips.....	82
VI. FAQ.....	84

I. Product introduction

1. Brief introduction

MOTOEYE E6



MOTOEYE E6-SE



MOTOEYE E6/E6-SE is a smart helmet HUD (Head Up Display) for motorcycle riding. HUD is very common in the automotive industry, but HUD equipment on motorcycles is still in its infancy. MOTOEYE innovatively applies AR display technology to the field of motorcycle riding, with heads-up display, high frame rate camera, Bluetooth, navigation, voice control, Mesh intercom, network intercom, CarPlay, HiCar, Android auto, etc. The function allows information to be displayed “right before your eyes” and makes interaction simpler, aiming to use the power of technology to make cycling simpler, safer and more fun. E6/E6-SE adopts module design. The HUD host is installed behind the helmet, and the display module is installed on the brim of the helmet. It can be easily installed on different styles of helmets, such as full-face helmets, half-face helmets, and face-up helmets.



E6



E6-SE

Features of E6/E6-SE

- 24° FOV & See-Through display
- CarPlay
- HiCar
- Android Auto
- Mobile screen mirroring
- 120° wide angle FHD camera
- 1080p 30fps video
- Dual-mode Bluetooth
- Caller ID, EANS voice noise reduction and echo cancellation algorithm
- 40mm large size headphones
- GPS navigation
- Voice control
- Local music
- Mesh intercom

- Public network intercom
- Support wireless connection for intercom
- Android and iOS APP
- WIFI5
- Bluetooth sharing mobile network
- 1400mAh built-in battery
- Bluetooth controller
- IP66 water proof
- 120° rearview camera (only for E6)
- Extended front camera module
- safety tail light (only for E6-SE)
- Extended battery pack(4000mAh)
- Colorful shell

2. Product parameters

Sort	Parameters
CPU	8core 1.8GHz
RAM	2GB (E6) 1GB (E6-SE)
Display FOV	24°
Display resolution	640x400
Display brightness	3000cd/m ²
Display contrast	10000:1
Video fps	1080p 30fps
WIFI	WIFI5
Bluetooth	Dual mode
Navigation	GPS
Headphone	Stereo 40mm headphone
Microphone	Noise canceling microphone
Noise reduction	ADSP
TF Card	Up to 256GB TF card
Battery	1400mAh
waterproof level	IP66
Rearview camera	E6 support

Extended battery (Optional)	4000mAh
Front camera (Optional)	Support

3. Features

3.1 HUD Display

MOTOEYE E6/E6-SE uses a 24° large field of view optical display module. The free-form surface optical technology makes the imaging clearer and more realistic. Its See-Through feature allows users to see the virtual image in the optical module while riding. You can also see the real scene of the outside world, and the display information is always presented in front of you, making riding safer. E6/E6-SE uses Sony's leading Micro OLED display, with a contrast ratio of up to 10000:1 and a brightness of 3000nit, making the outdoor display clearer. The virtual dashboard mainly displays time, riding speed, speed limit, status, battery and other information.

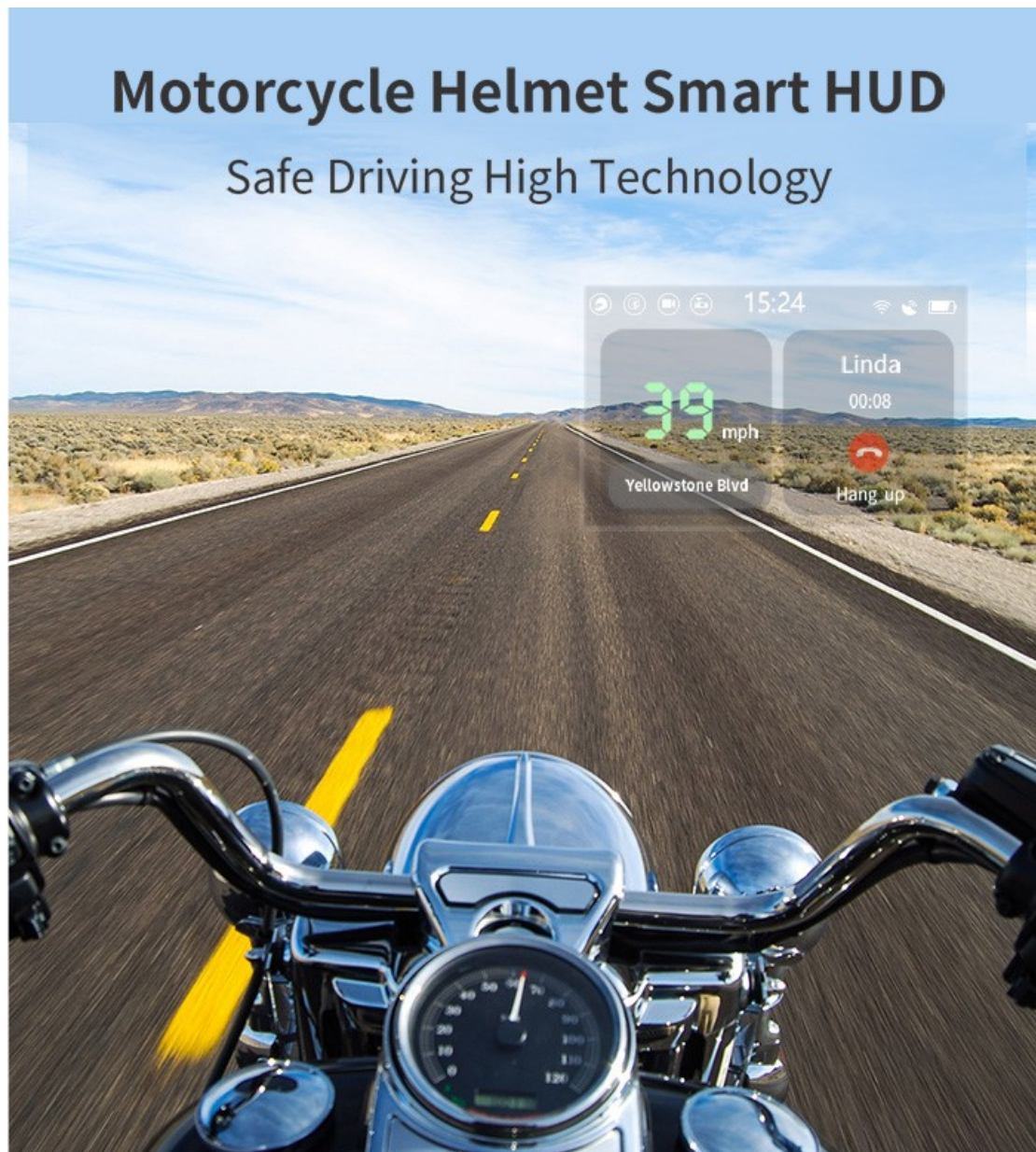

3.2 FHD photos and driving record videos

The driving recording function supports uninterrupted loop coverage of recording, allowing E6/E6-SE to escort the ride in the background. The supported driving recording resolution fps are 1080p 30fps and 720p 30fps. E6/E6-SE supports up to 256GB TF card to meet users' large-capacity storage needs.

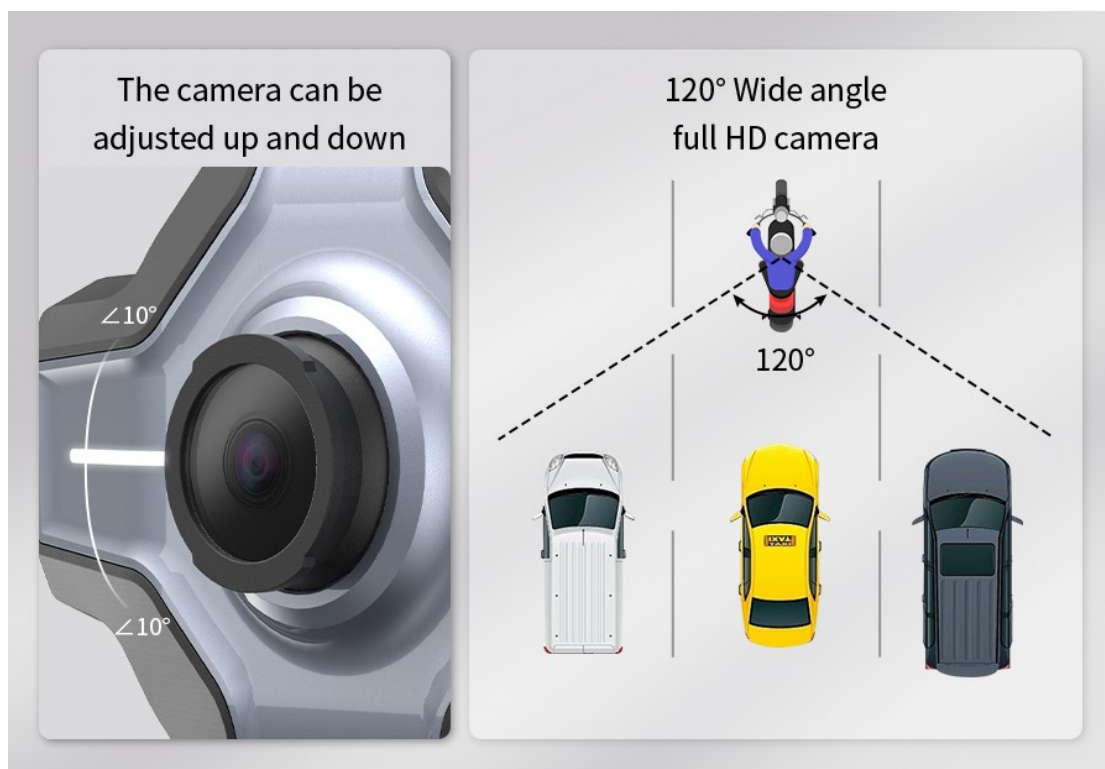

3.3 High-quality dual-mode Bluetooth

MOTOEYE E6/E6-SE uses Qualcomm dual-mode Bluetooth solution. After the mobile phone is connected to the HUD host via Bluetooth, the HUD can be managed through the APP, such as checking status, synchronizing photos and videos, etc. After Bluetooth connection, the mobile phone will automatically synchronize the contacts book to the HUD host. It has caller ID and voice command. It is very convenient to make calls or listen to Bluetooth music.

High-quality Bluetooth combined with 40mm large-size stereo headphones brings the ultimate audio experience to cycling. The microphone supports ADSP voice noise reduction and echo cancellation algorithms, making calls stable even while riding at high speeds.

Specially Tuning Bluetooth for Cycling

Display caller information

Professional ADSP noise reduction chip

Clear communication at 120Km/h



3.4 Navigation

HUD can display navigation information in front of you at all times. E6/E6-SE can be connected to CarPlay, HiCar, and Android Auto, use its navigation APP to map route planning and navigation, and project the navigation screen on HUD.

Two Navigation Modes

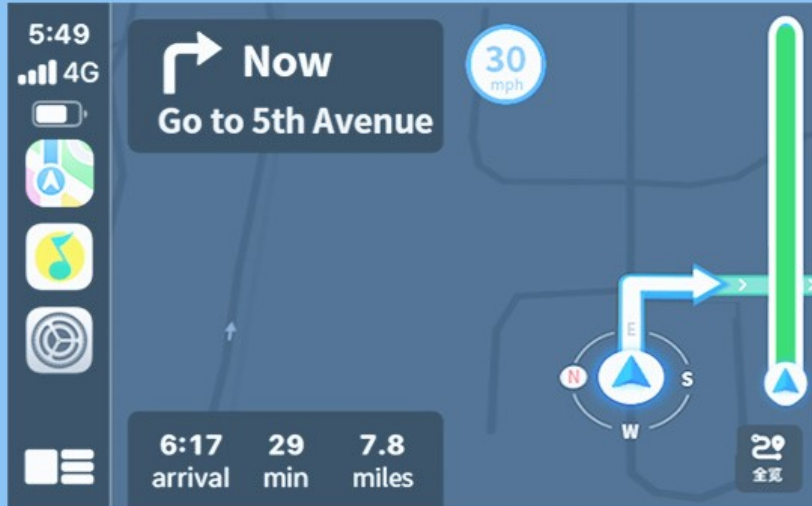

Full screen mode

Rich navigation information

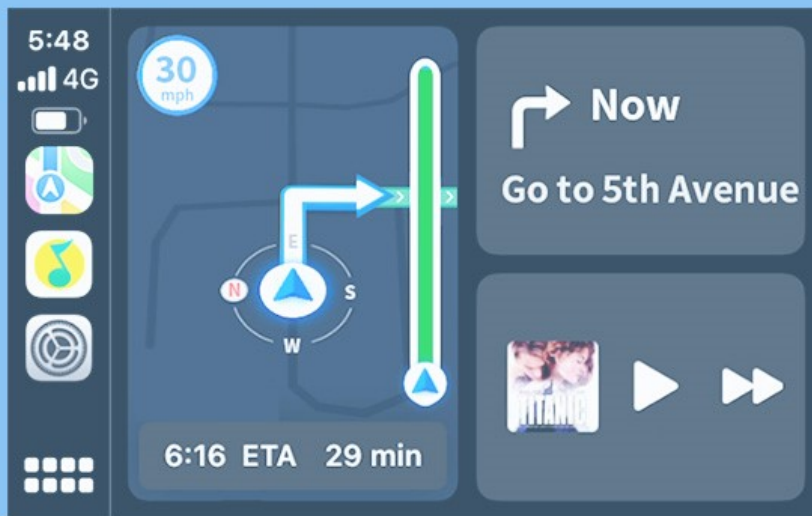

Thumbnail mode

Navigation and music display at the same time

3.5 Apple CarPlay

CarPlay is a smart car solution launched by Apple. This function is designed to connect the mobile phone's operating system and the HUD's virtual display, and extend the applications and services of iPhone to the HUD's virtual screen.

The OS run independently

The CarPlay interface displayed on the HUD does not interfere with the mobile phone interface.



Split screen display

View the route, music or phone information being navigated at the same time.

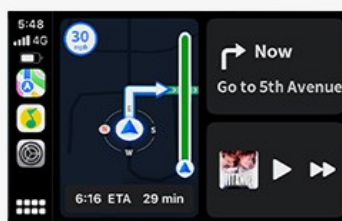

Support for navigation Apps

Support mainstream third-party navigation APPs, such as Google Map, Apple map, Waze and so on.

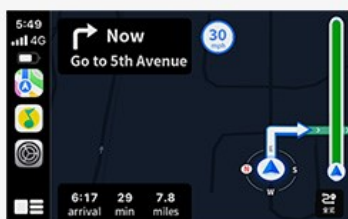

Support for music Apps

Support mainstream third-party music software, such as QQ Music

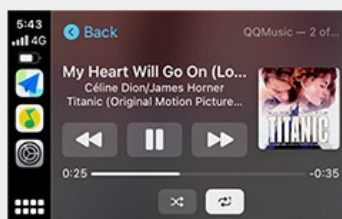

Just listen to the message

You don't need to take out your iPhone to check your SMS when riding, Just Let Siri read them.



“Hey, Siri”

Make phone calls, set navigation destinations, and switch music. All these are left to Siri voice assistant.



3.7 Huawei HiCar

HiCar is an interconnection system launched by Huawei. This function is designed to wirelessly interconnect Huawei phones and HUD screens, establish a pipeline between Huawei phones and HUD, and extend mobile applications and services to the HUD virtual screen.

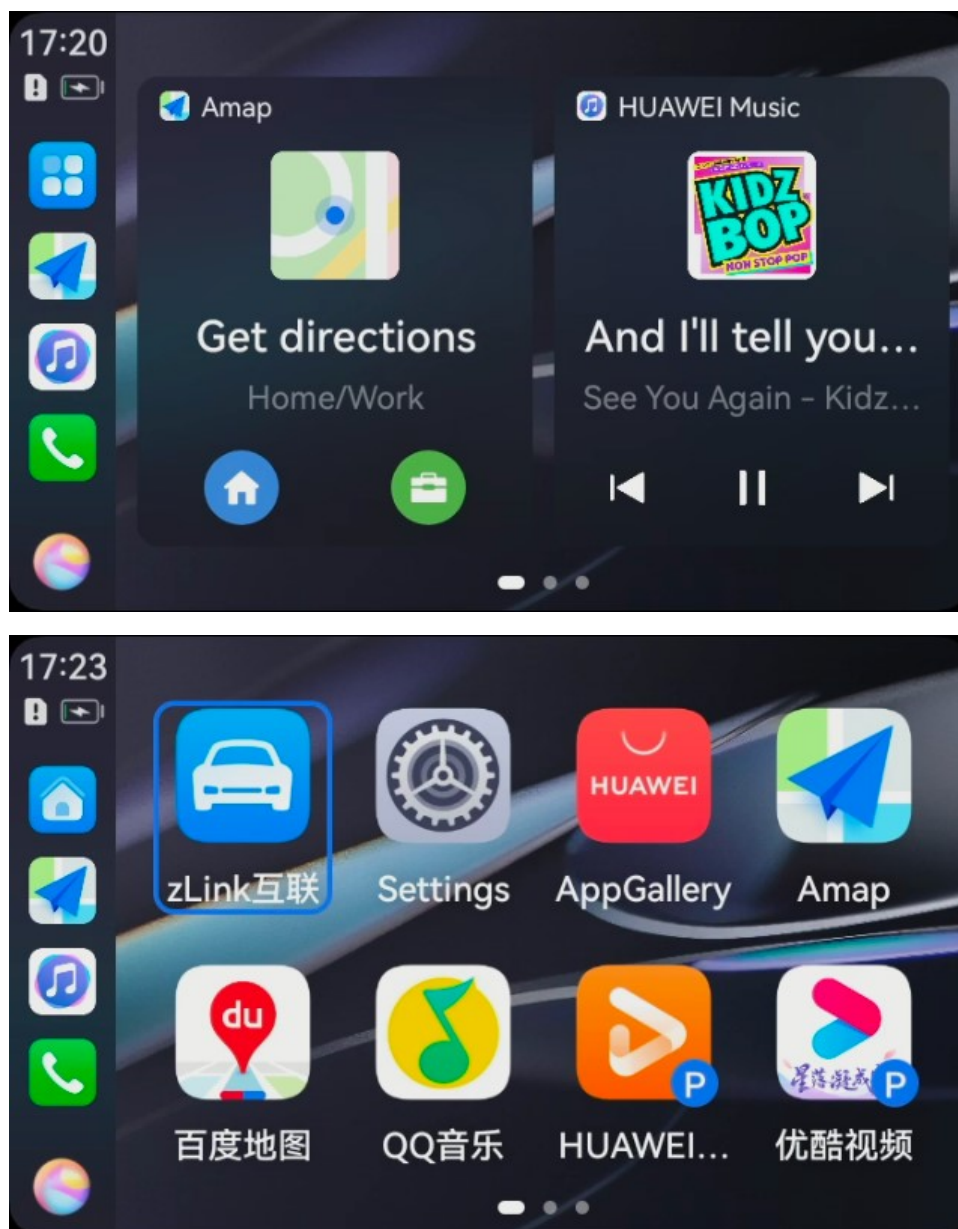

3.6 Android Auto

Android Auto is an interconnection system launched by Google. This

function is designed to wirelessly interconnect Android phones and HUD screens, establish a pipeline between Android phones and HUD, and extend mobile applications and services to the HUD virtual screen.

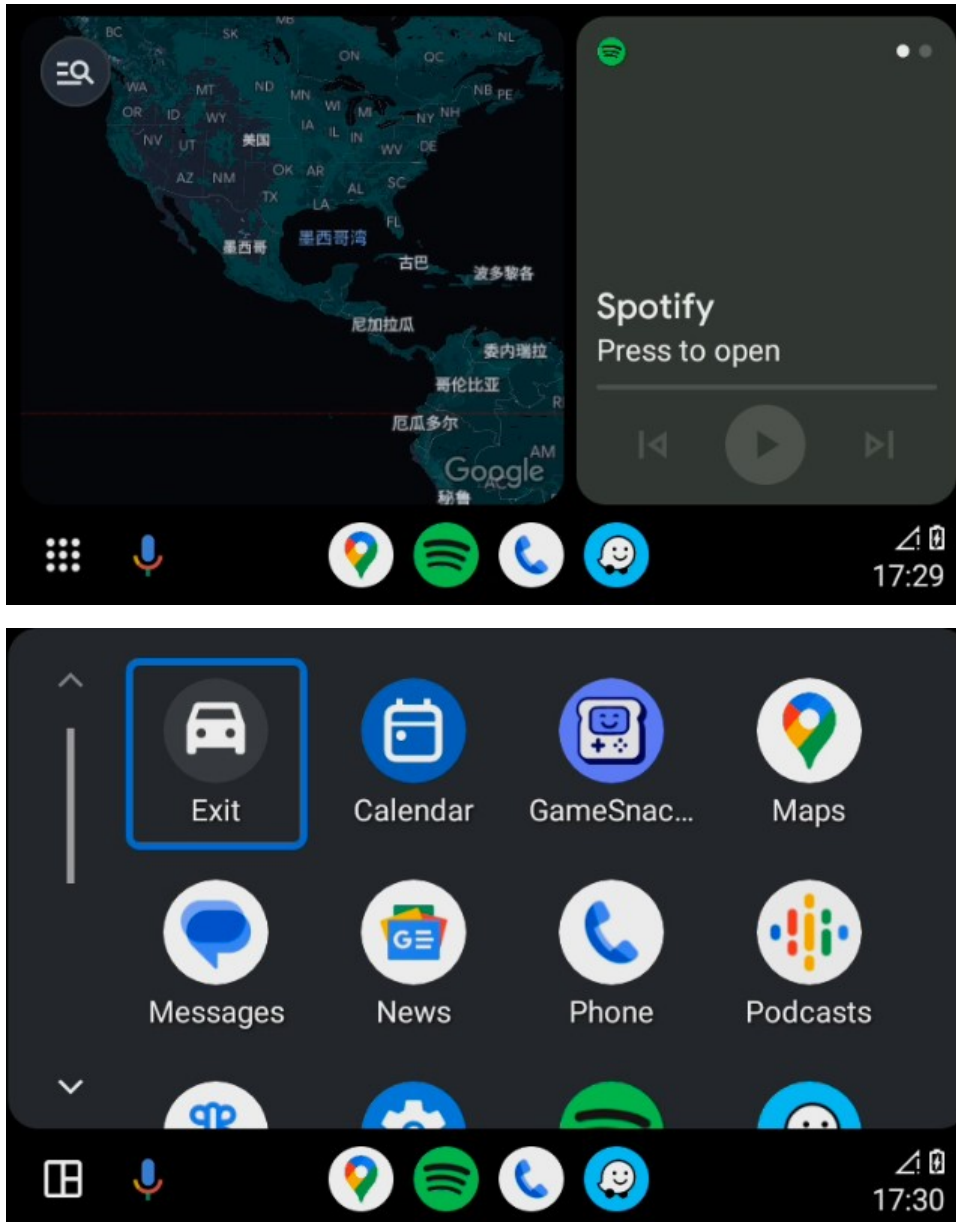

3.8 Mobile screen mirroring

The mobile screen mirroring function can wirelessly project the mobile phone screen to the HUD virtual screen through WiFi, and simultaneously synchronize the mobile phone sound to the HUD headset. It can project all

the applications on the mobile phone and cast whatever you want.



3.9 Music

MOTOEYE E6/E6-SE supports Bluetooth music and local TF card music playback.

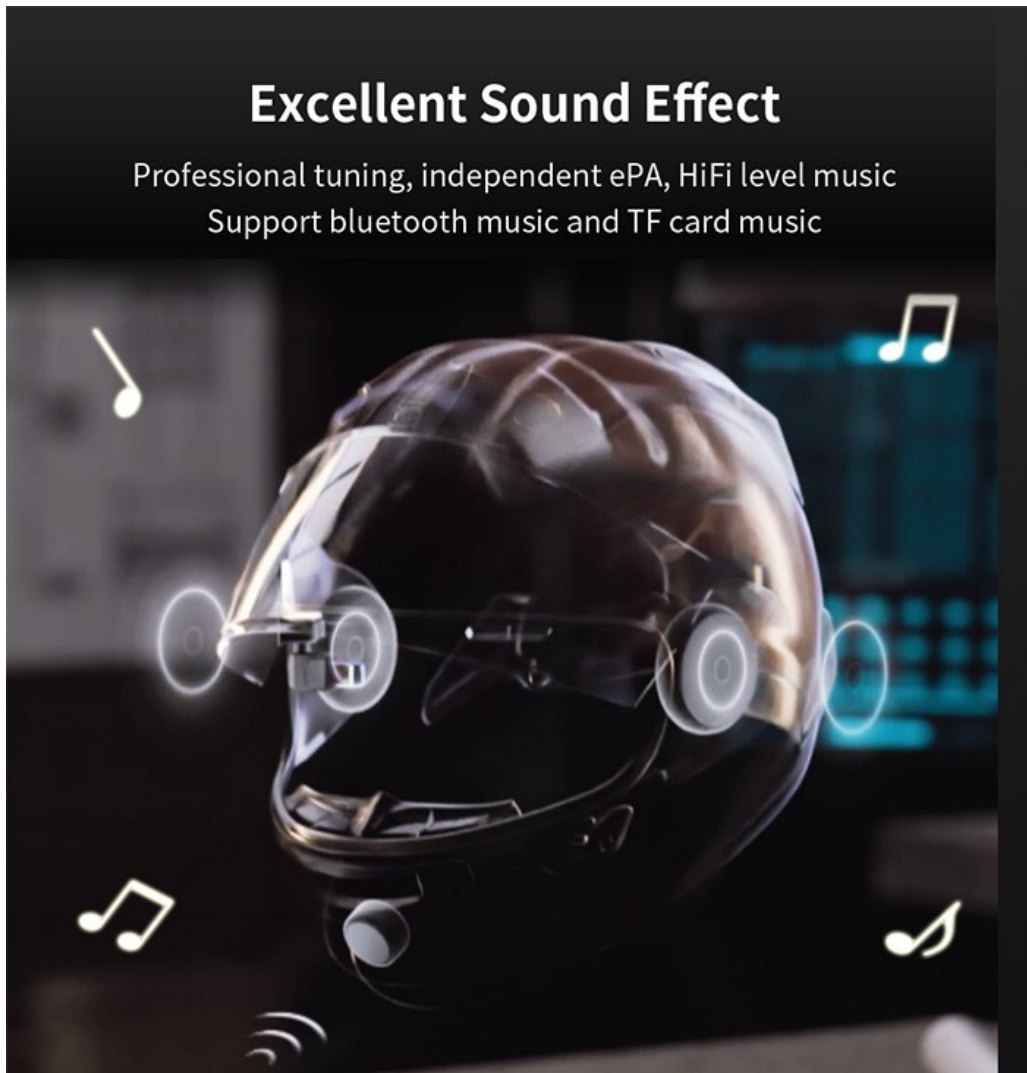

3.10 Public network intercom

The intercom function of MOTOEYE E6/E6-SE is very rich. In urban areas with cellular networks, users can use network intercom with teammates. There is no limit to the intercom distance. Up to 15 people in the same team can talk together in full duplex at the same time.



3.11 Wireless connect to walkie-talkie

In mountainous areas where there is no cellular network, users can use Xiaomi walkie-talkie to wirelessly connect to E6/E6-SE. The walkie-talkie serves as a mobile phone and E6/E6-SE serves as a Bluetooth headset. By long pressing the PTT button on the Bluetooth controller (i.e.: camera button), you can intercom with teammates. This intercom method does not limit the number of people talking. The intercom distance depends on the transmitting

power of the mobile phone, and generally supports 5 kilometers. E6/E6-SE does not require wired connection to the intercom, and does not require additional PTT buttons, making it safer and more convenient to use.



3.12 Mesh intercom

MOTOEYE E6/E6-SE supports mesh self-organizing network technology, which enables convenient and efficient communication within teams without relying on the internet. Supports point-to-point communication within 800 meters,

with a maximum communication distance of 5 kilometers for 9 people.



3.13 Voice control

MOTOEYE E6/E6-SE supports a variety of interaction methods, among which voice control can free up the user's hands to the greatest extent and improve riding safety. The voice control function of E6/E6-SE is very convenient, and can control opening APP, adjusting volume, Adjust brightness, etc.

3.14 Bluetooth remote controller

In order to facilitate the safe operation of the device during riding,

MOTOEYE E6/E6-SE supports remote operation with the handlebar Bluetooth controller. The Bluetooth controller adopts a quick-release structure and waterproof design and can be used in the rain. It uses CR2032 button battery and has a battery life of more than 12 months with regular use.



3.15 Light control

For the safety of night riding, the E6/E6-SE main unit is equipped with high-brightness tail lights (only for E6-SE) and colorful ambient lights, and can be set to a variety of lighting effects. Automatic opening can be set according to personal needs.

High Brightness Flash Lamp



Safer to ride at night





4. Differences between E6 and E6-SE

	E6	E6-SE
--	----	-------

Appearance		
Installation location	Behind the helmet	Behind the helmet
RAM	2GB	1GB
Battery	1400mAh	1400mAh
Weight	80g	80g
Navigation	GPS+Beidou	GPS+Beidou
Noise reduction	Dual mics	Dual mics
WiFi	5G WiFi	5G WiFi
Bluetooth	4 Cores	4 Cores
Mesh Intercom	Support	Support
Rearview camera	Support	Not Support
Front camera	Optional	Optional
Atmosphere light	Support	Support
Flash tail light	Not Support	Support
Colorful shell	Support	Support
Bluetooth call	Support	Support
Caller ID	Support	Support
Voice command	Support	Support
Local music	Support	Support

Bluetooth music	Support	Support
Wireless connect to walkie-talkie	Support	Support
Public network intercom	Support	Support
Driving record	Support	Support
Bluetooth sharing mobile network	Support	Support
Apple CarPlay	Support	Support
Huawei HiCar	Support	Support
Android Auto	Support	Support

5. APP download

When using the HUD for the first time, you need to download the MOTOEYE APP on your mobile phone and connect it to the HUD. The HUD will automatically complete the language, time zone, time and other settings.



MOTOEYE APP

II. E6/E6-SE Installation

1. Packing list

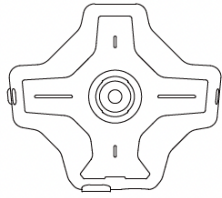

HUD host x 1

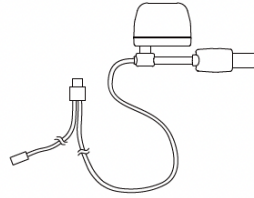

Display module x 1



Remote controller x 1

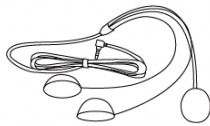

Headset x 1

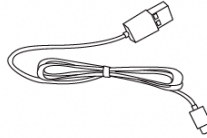

TypeC cable x 1



Display extension rod x 1

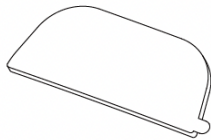

Display back glue A x 2

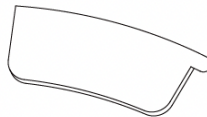

Display back glue B x 2



Host back glue A x 2

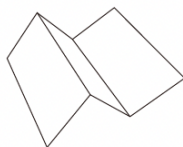

Quick guide x 1

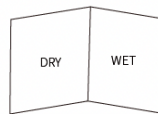

Cleaning kit x 2

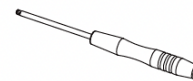

Cross screwdriver x 1

2. Appearance description

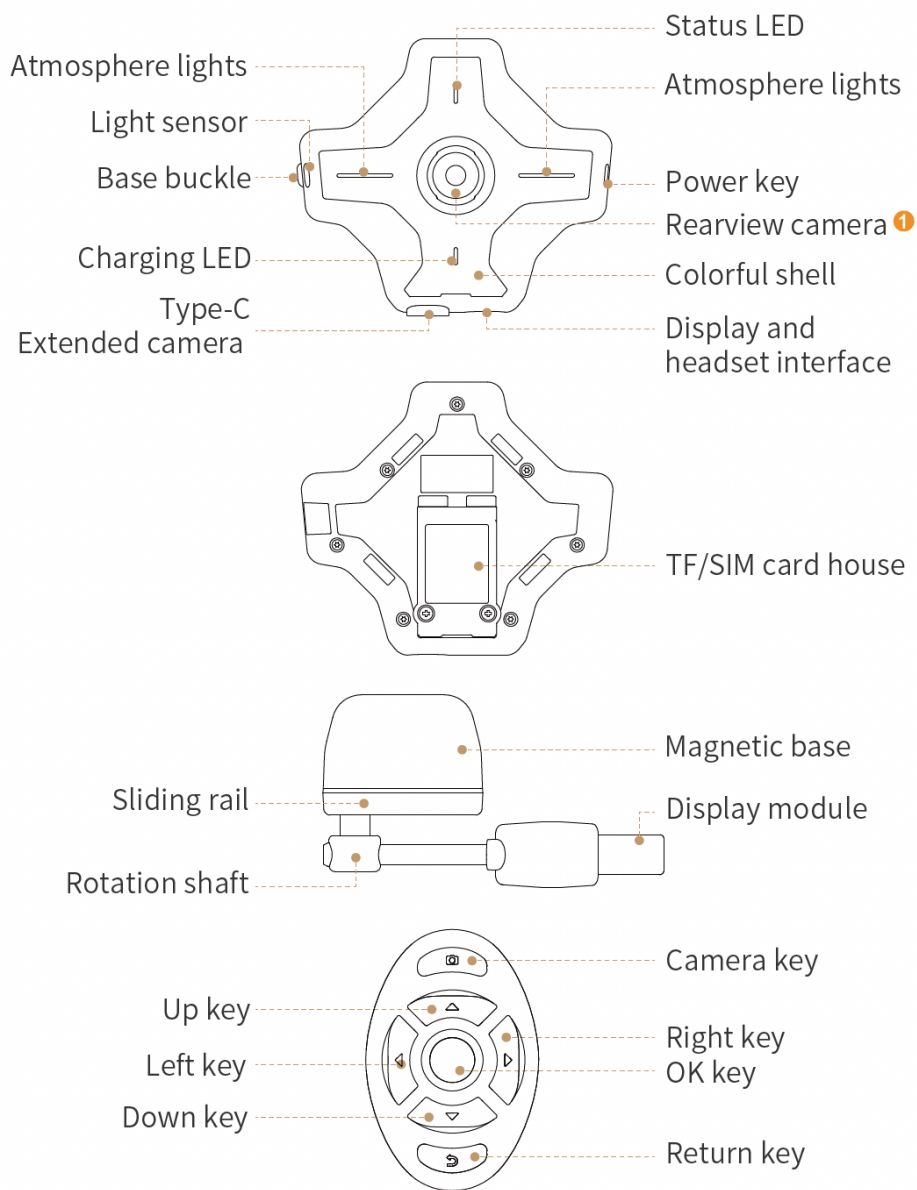

① For the M6 and E6, this is the rearview camera location, for the M6-SE and E6-SE, this is the RGB tail light location.

3. Install HUD host

(1) Remove the release paper from the base of the host.

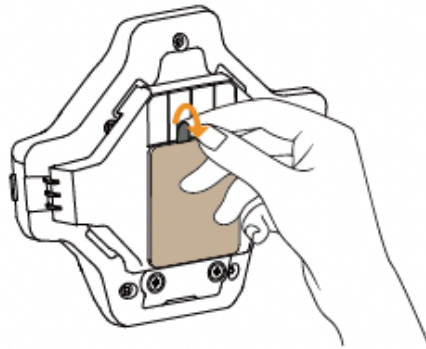

(2) Stick the base of the host behind the helmet and press it down until it is firmly attached.

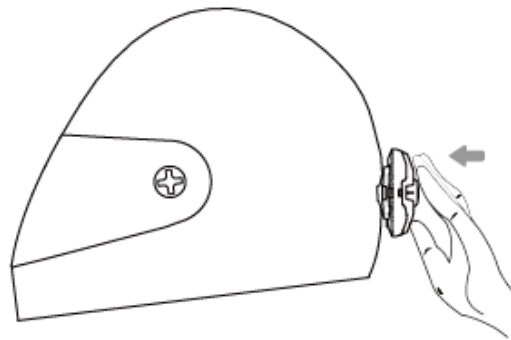

(3) Adjust the camera's perspective up and down (only for E6).

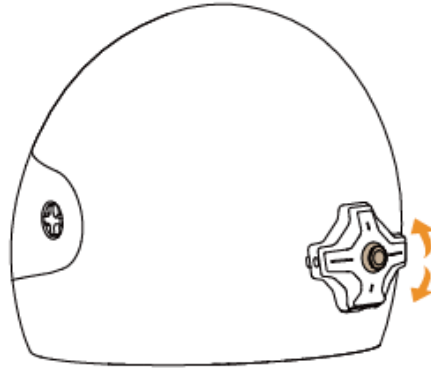

(4) To remove the host, gently press the latch on the base of the host, and then remove the host.

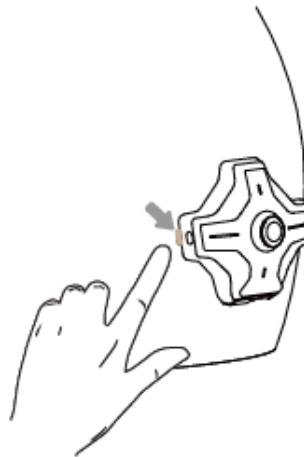

4. Install display module

(1) Paste the back glue on side A or side B of the display module base.

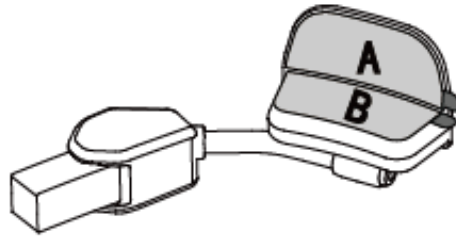

(2) Paste the base of the display module onto the brim of the helmet, so that the prism of the display module is in a position that is directly forward and upward of the human eye.

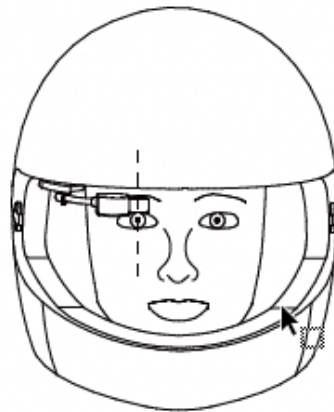

(3) Insert the plug of the display module cable into the display jack of the HUD host.

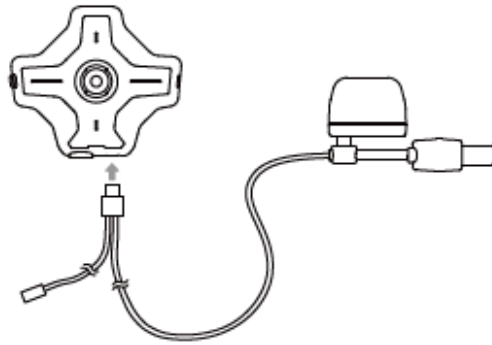

(4) Putting on the helmet and power on the HUD, fine tune the rotation shaft and sliding rail, so that you can see the image in the display module clearly.

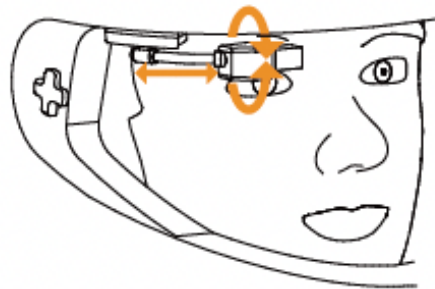

5. Install headset

Remove the release paper on the back of the headphones and microphone, stick it to the reserved position on the inside of the helmet, and insert the earphone plug into the earphone jack.

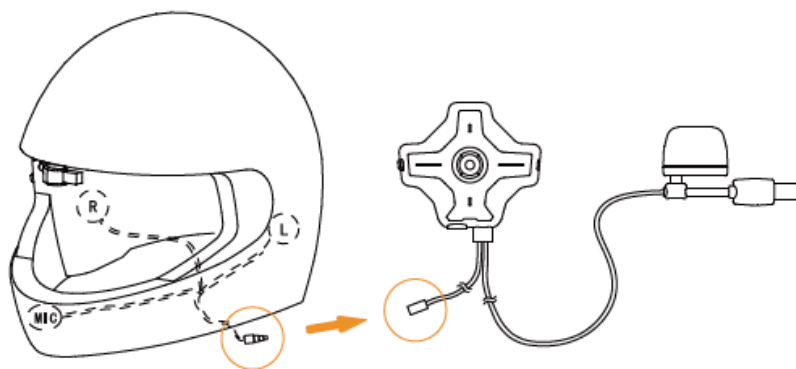

6. Install TF card

Use a cross screwdriver to open the TF card house, install the TF card, and then install the cover. (Some models in some countries do not support cellular network and SIM card installation)

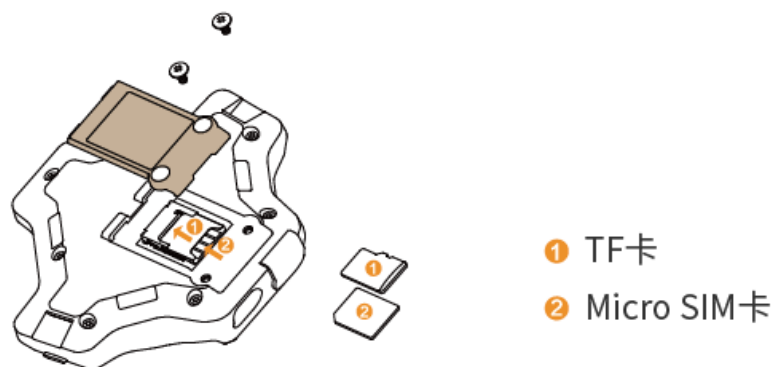

7. Storage cable

After installation, insert the exposed cables into the gap between the helmet and the internal sponge.

8. Install remote controller

(1) Rotate the controller counterclockwise to remove it from the base.

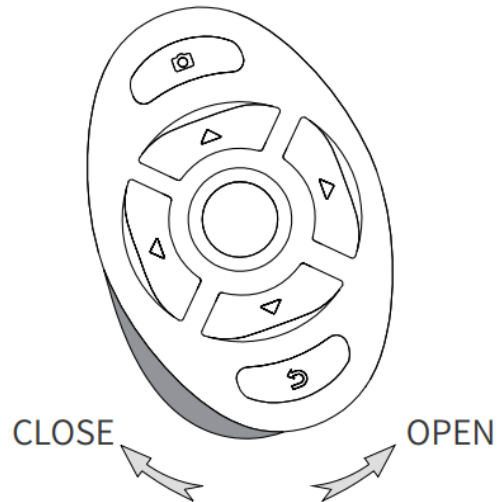

(2) Use a wrench to install the controller base onto the bracket and attach the back glue to the arc position of the bracket.

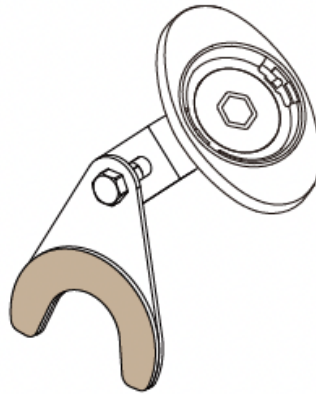

(3) Remove the release paper from the bracket, paste the assembled bracket onto the handlebar, and press to ensure reliable installation.

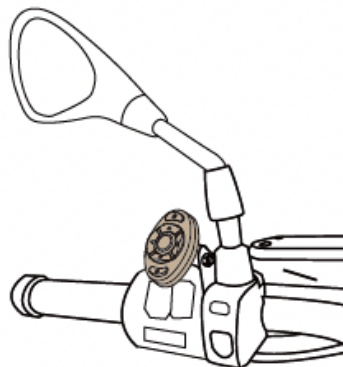

(4) If need to replace the battery, you can use a coin to open the battery cover and replace the battery.

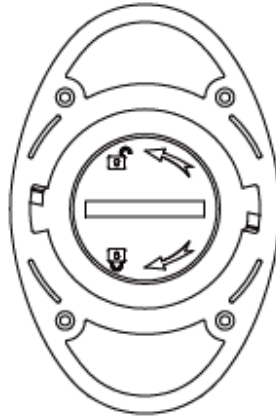

9. Definition of key

key	Short press	Long press (2s)
Power key	On/Off screen	Power on/off
Up/Down key	Up/Down move	Increase/Decrease volume
Left/Right key	left/Right move	--
OK key	Confirm	Start voice control
Return key	Return/back	Go back home
Camera key	Start rearview mirror	Start/stop DVR Intercom PTT

10. Definition of LEDs

LEDs	On	Off
Status LED-green	Power on	Power off
Status LED-blue	Camera is working	Camera is not working
Charging LED	Charging	Charged

III. E6/E6-SE using manual

1. Power on/off

Press and hold the power key for 2s to power on/off. After the HUD host is power on, short press the power key to standby/wake up the Display module.

note:

Please connect the display module plug to the host before power on. If an abnormality occurs, pressing and holding the power button for 10s can forcibly restart the device.

2. Charging

Please use a 5V charger.

When charging: the red charging indicator light remains on.

When fully charged: the charging indicator light goes off.

The charging time of the HUD is about 2.5 hours at a time.

3. Volume control

Long press the up key to increase the volume.

Long press the down button to decrease the volume.

4. Connection between MOTOEYE APP and HUD host

- (1) Power on the HUD.
- (2) Download MOTOEYE mobile APP, register and log in.
- (3) Click on the "Device" on the APP homepage.
- (4) Search for the HUD host and click on the name to connect, the name of HUD Bluetooth is : "Device model" - "SN number", such as E6-47C132C2.

(5) After connected, the "Device" page will display the device information.

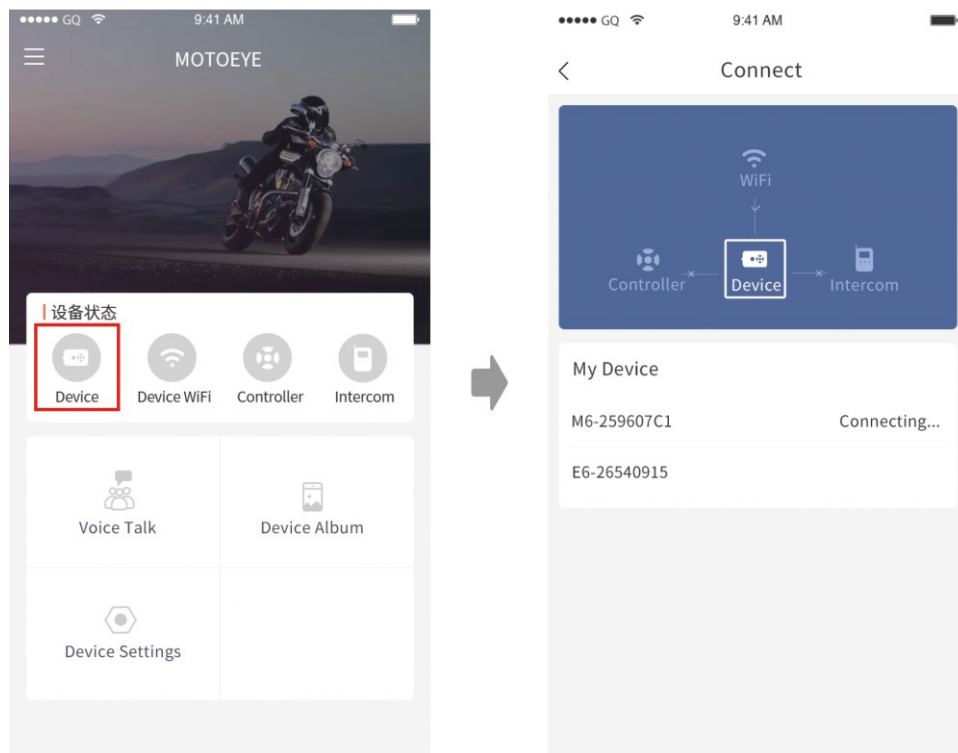

After the connection is successful, the user's avatar changes from the unlogged state to the logged in state on the main interface of E6/E6-SE. If the user has set an avatar on the mobile APP, the user's customized avatar will be displayed.

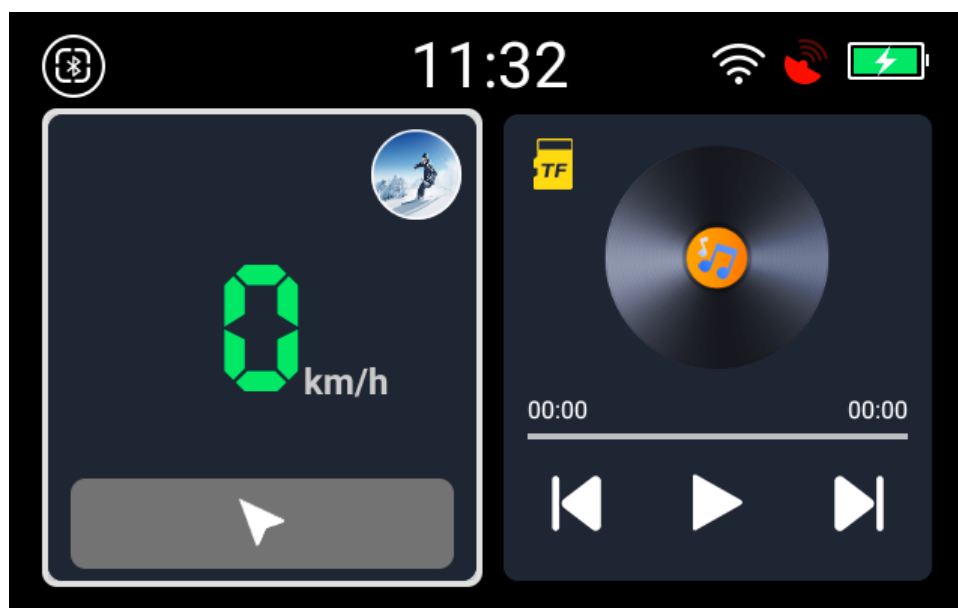

Notes:

Bluetooth connections are including BLE data connections and Bluetooth audio connections. Data transmission between the MOTOEYE APP and the mobile phone is transmitted through the BLE data connection, and the Bluetooth phone and Bluetooth music functions are transmitted through the Bluetooth audio connection.

Android phone: Android mobile APP can establish Bluetooth data and audio connection between HUD and phone simultaneously. (Some models need to manually connect Bluetooth audio in the system settings).

iPhone: The iOS APP can only establish a Bluetooth data connection between HUD and the phone, and the audio connection needs to be manually connected in System Settings - Bluetooth Connection.

5. WiFi Connection

Method 1: Connect to WiFi through MOTOEYE APP

(1) After the MOTOEYE APP establishes a connection with the HUD host, click the "WiFi" button on the "Device Connection" page or the main page.

(2) Select the WiFi you wanted and enter the password to connect.

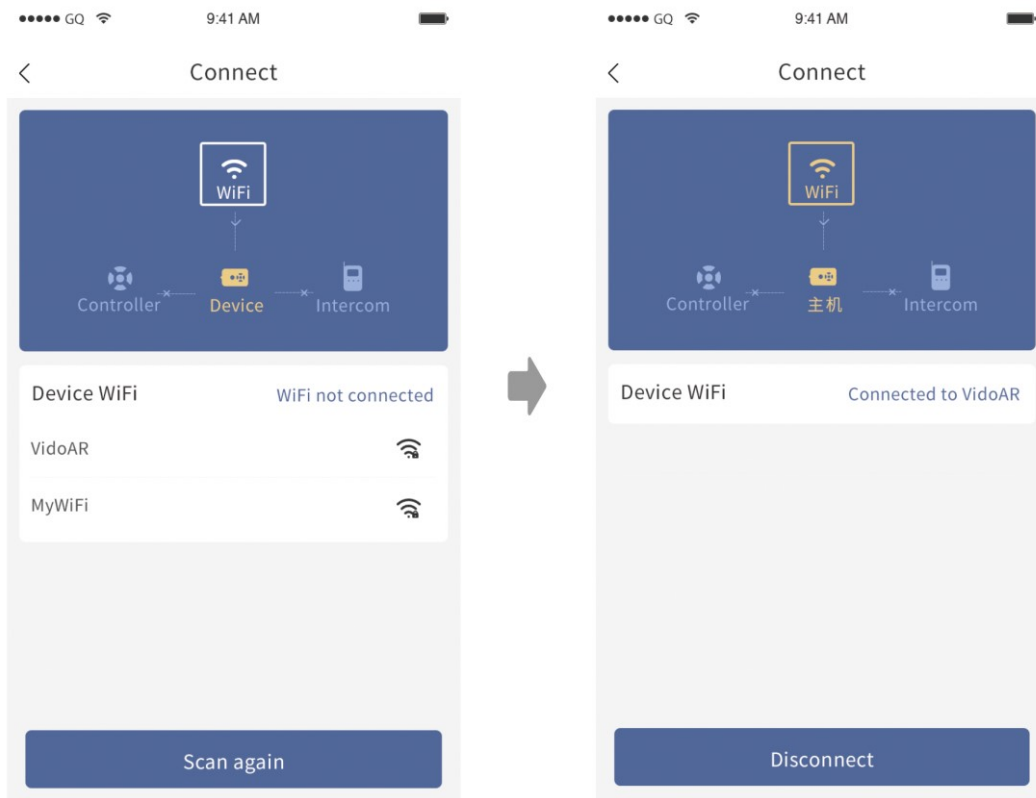

Method 2: Connect to WiFi through HUD host

- (1) Enter "Settings" and then select "WiFi Connection" on HUD,
- (2) Select "WiFi Manual Connection", and then select the WiFi name you want to connect to.
- (3) Enter password to start connecting.

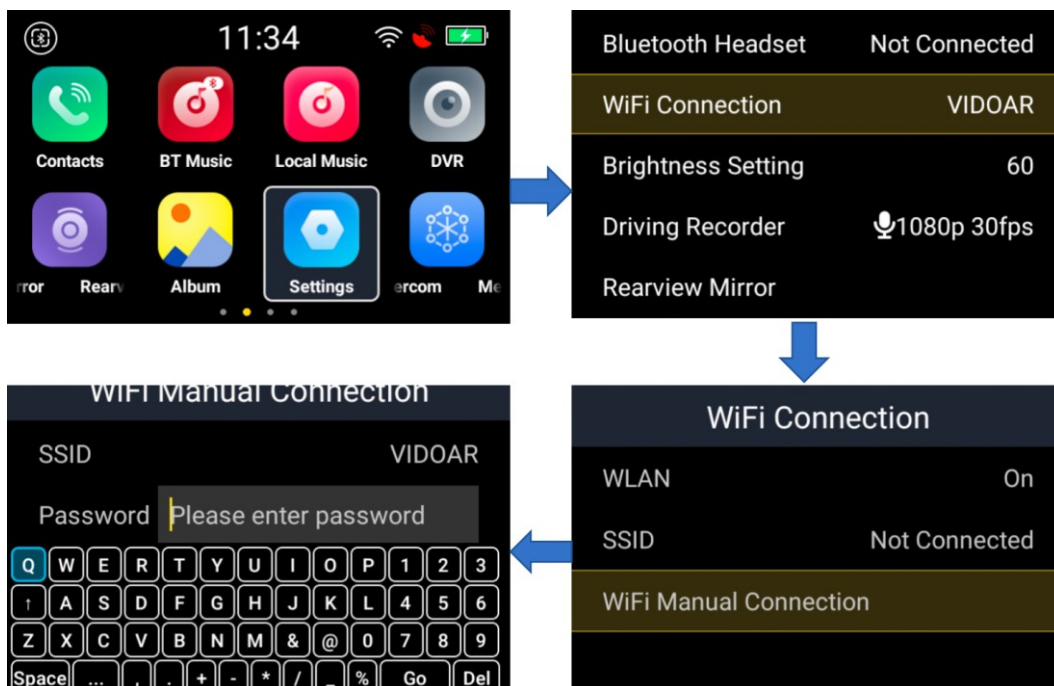

6. Share mobile network through Bluetooth

➤ Preparation before connection

1. iPhone: Turn on the 'Personal Hotspot' switch.
2. Android phone: Turn on the "Bluetooth shared network" switch.

➤ Manual connection

1. Turn on Bluetooth on the mobile phone and ensure that it is in the "Discoverable" state.
2. Open "Settings" - "Bluetooth Network" - "Manual Connection" on the HUD device and search for nearby Bluetooth devices.
3. Select the Bluetooth name of the mobile phone and click the "OK" button to connect.
4. A Bluetooth connection dialog box will pop up on the mobile phone, click "Connect".
5. After the connection is successful, the icon of the Bluetooth network will be displayed in the status bar of the HUD home page.

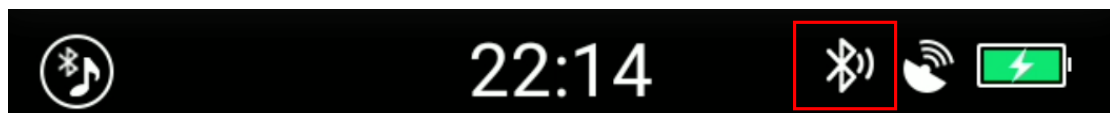

➤ Auto Connection

1. Open "Settings" - "Bluetooth Network" on the HUD device and turn on "Auto Connection",
2. The Bluetooth network will automatically connect when connecting to Bluetooth audio.

➤ Disconnection

1. For HUD devices that have been connected to the Bluetooth network, you can see the name of the connected device in "Settings" - "Bluetooth Network"

2. Click the name of the connected device to disconnect from the Bluetooth network.

7. Connect to Bluetooth controller

1. Press and hold the camera button and return button of the controller simultaneously for more than 3 seconds. At this time, the red and blue lights on the remote control flash alternately.
2. After establishing a Bluetooth connection between the phone and the HUD host, click the controller button on the APP homepage or "Device Connection" page.
3. Click on "Search Bluetooth Controller".
4. Select the Bluetooth controller to connect to.

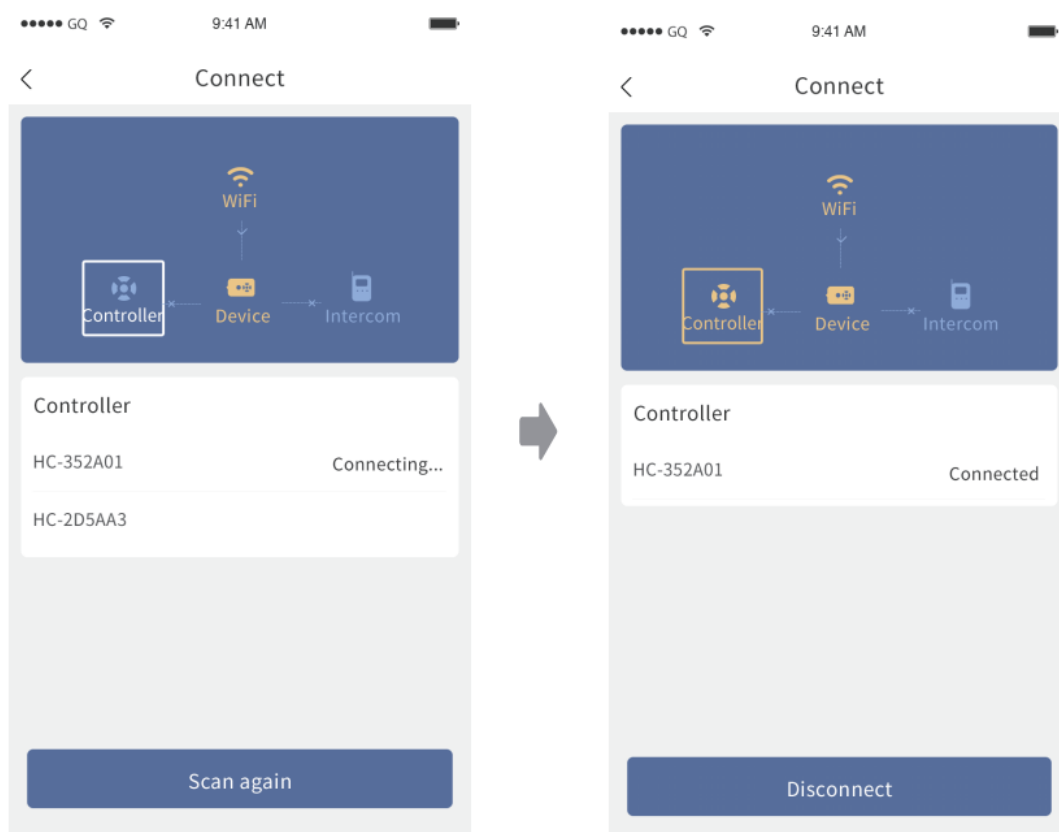

Notes:

After the HUD is turned on, press any key on the remote controller and wait for a few seconds. The controller can resume connection to the HUD.

After the HUD shuts down, the remote controller will automatically enter low-power sleep mode.

8. Connect to walkie-talkie

The E6/E6-SE host supports wireless connection to a walkie-talkie with Bluetooth communication function. After the connection, the walkie-talkie serves as a communication terminal, and the E6/E6-SE serves as a Bluetooth headset and PTT button. The connection method is as follows:

(1) In the phone settings, disconnect the Bluetooth audio connection between the phone and the HUD,

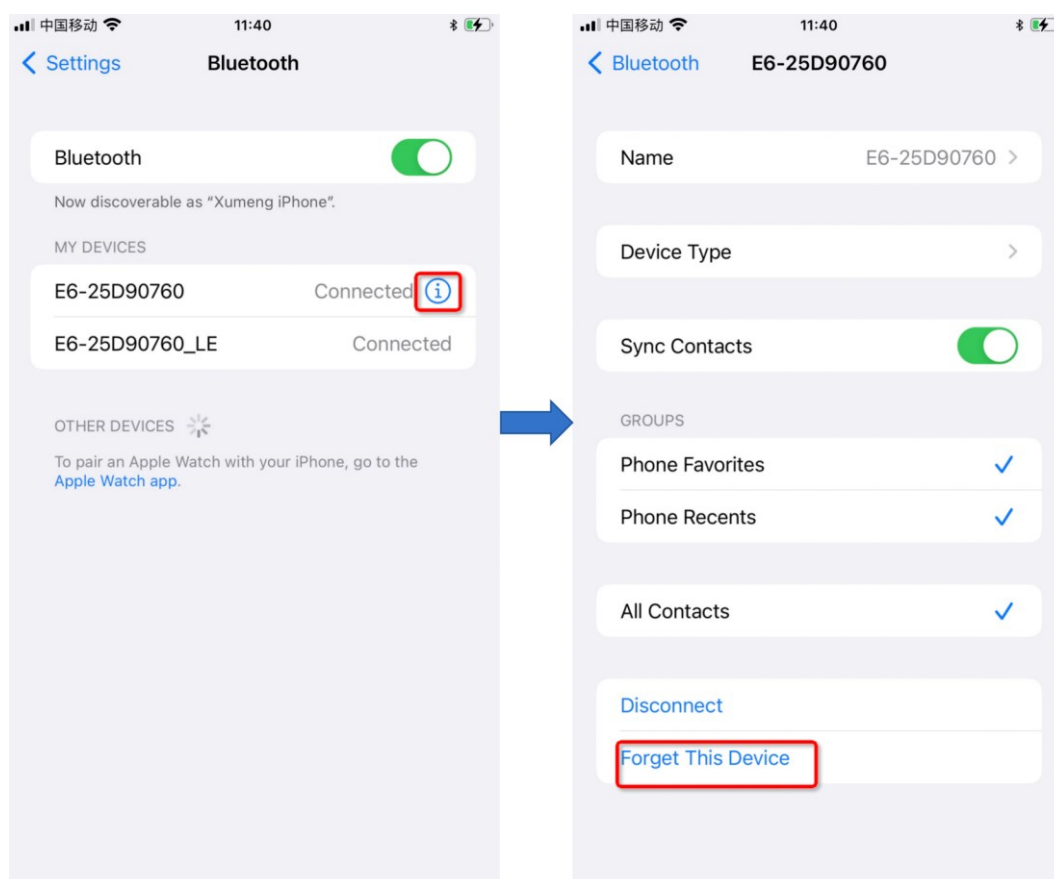

(2) Use a walkie-talkie with Bluetooth function to search for the Bluetooth headset named "E6/E6-SE-xxxxxx" and connect to it,

(3) After the connection is successful, you can press the intercom PTT button on the Bluetooth controller (i.e.: long press the camera button) to

intercom with teammates in the same channel.

The walkie-talkie devices supported are as follows:



9. Setting of UI style

The E6/E6-SE HUD host has two UI styles: grid mode and card mode, which can be set in the MOTOEYE APP or the HUD Settings.

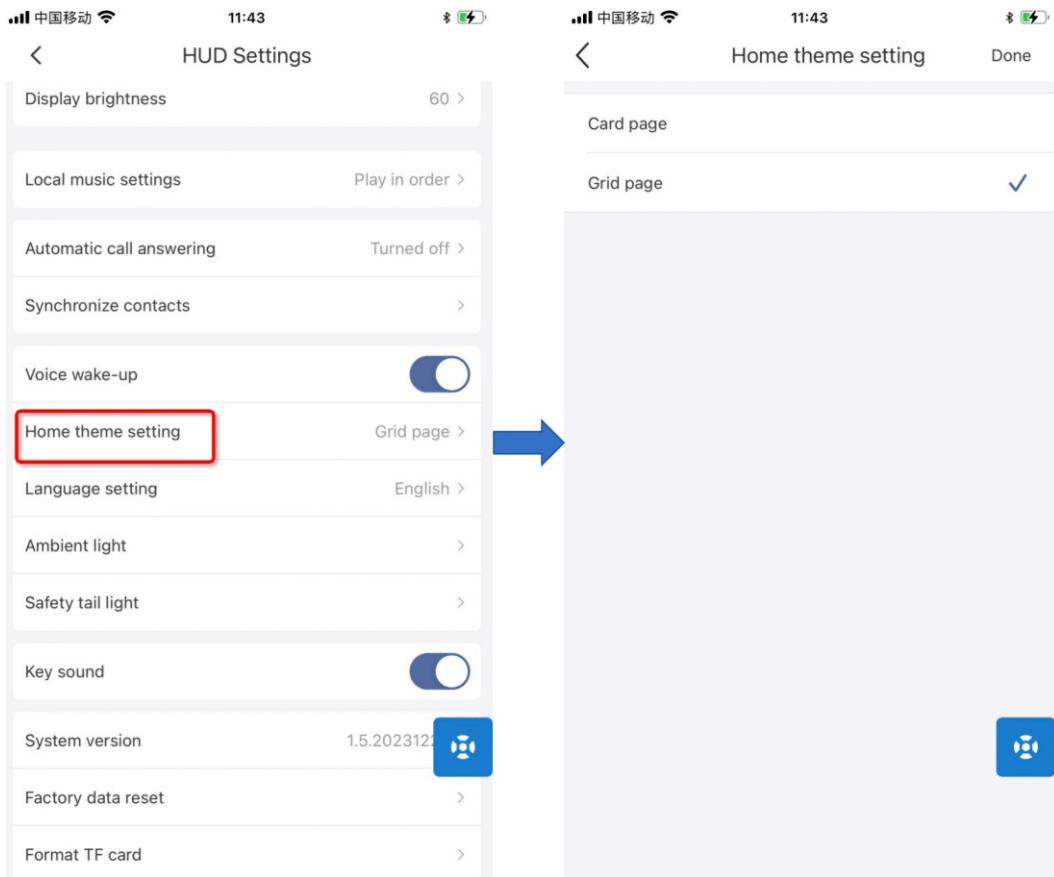

Grid mode is as follows:

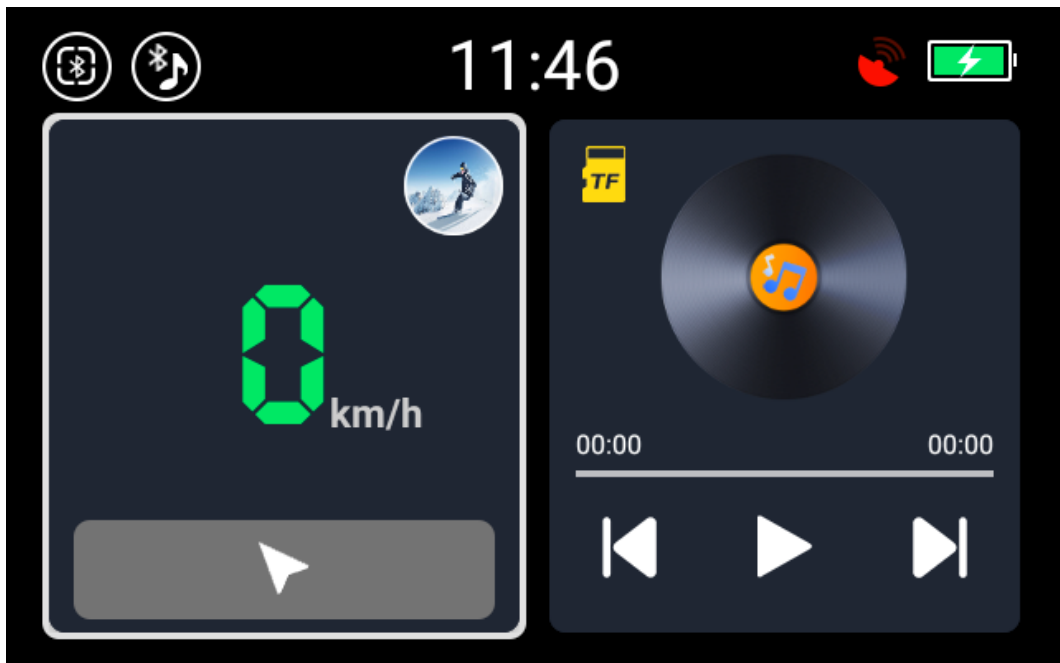

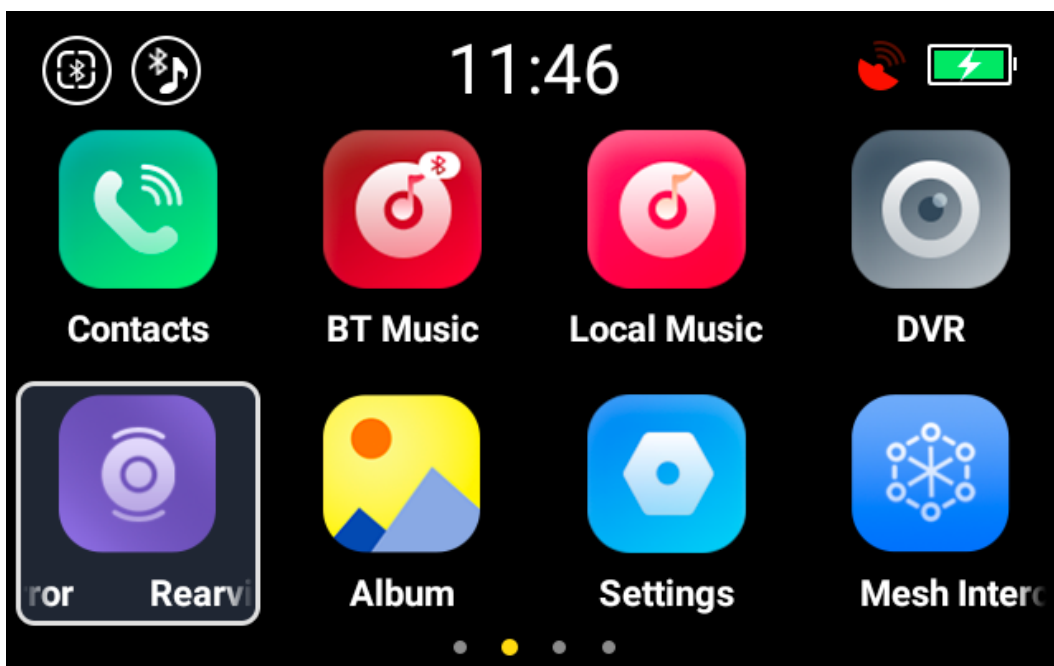

The grid mode homepage displays the speed and music player side by side. It mainly displays the current speed and music player, speed limit, application status and other information. Press and hold the return key on any interface to directly return to the homepage. You can use the front, back, left, and right buttons of the Bluetooth controller to switch interfaces.



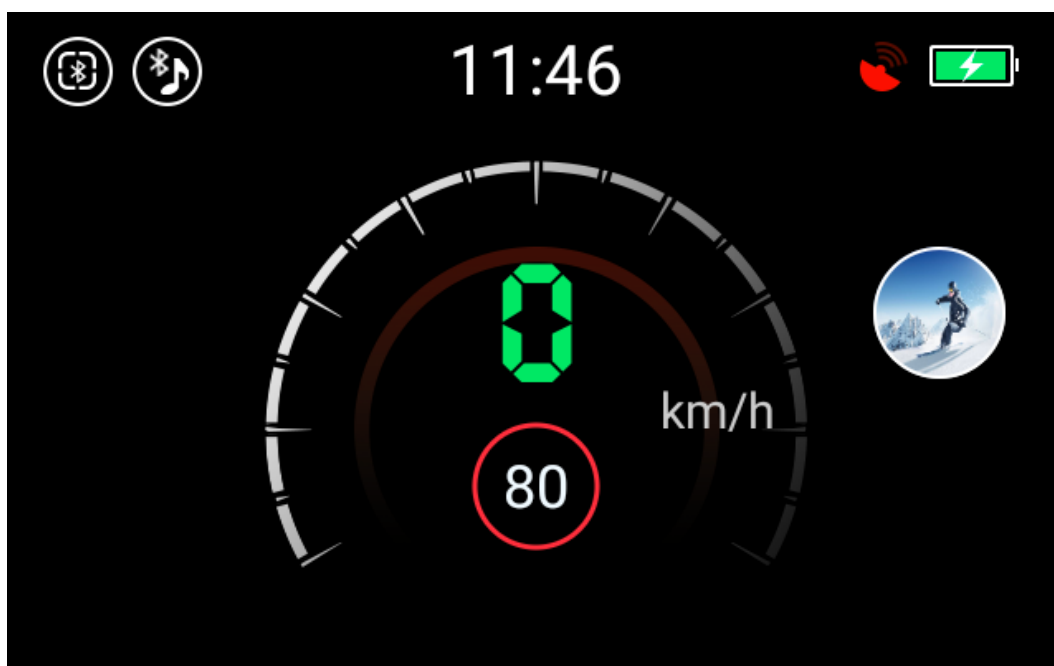

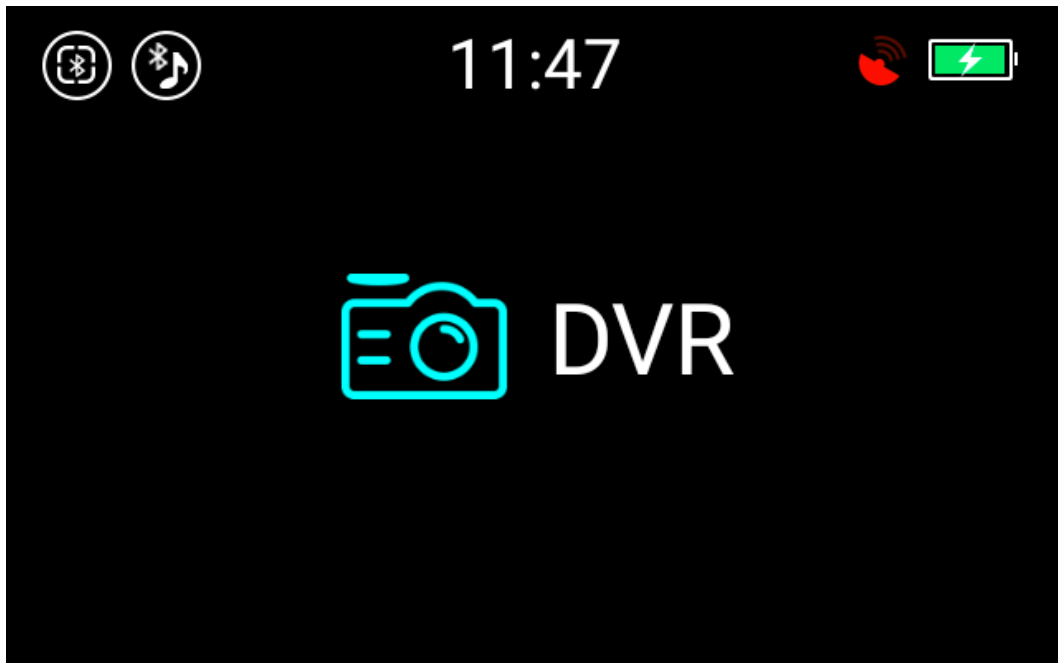

Card mode is as follows:











The main page of the card mode is a virtual dashboard, which mainly displays the current riding speed, speed limit, application status and other information. Long press the return key on any interface to directly return to the virtual dashboard interface. You can use the up and down buttons of the Bluetooth controller to switch interfaces.

The status bar icon description is as follows:

Icon	Meaning
	Bluetooth controller is connected
	Bluetooth audio connected
	Driving Record
	Public network intercom
	Connect Bluetooth walkie-talkie
	WiFi
	Bluetooth network

	GPS has positioned
	GPS signal is weak
	Charging
	Low battery
	User is not logged in
	User default avatar
	Mesh intercom

10. Navigation

Method 1: Using CarPlay

(1) Use HUD to connect iPhone CarPlay (see CarPlay function description for details)

(2) Select the navigation software supported by CarPlay on your mobile phone to navigate.



Method 2: Using HiCar

(1) Use HUD to connect Huawei HiCar (see HiCar function description for details)

(2) Select the navigation software supported by HiCar on your mobile phone to navigate.



Method 3: Using Android Auto

(1) Use HUD to connect Android Auto (see Android Auto function description for details)

(2) Select the navigation software supported by Android Auto on your mobile phone to navigate.

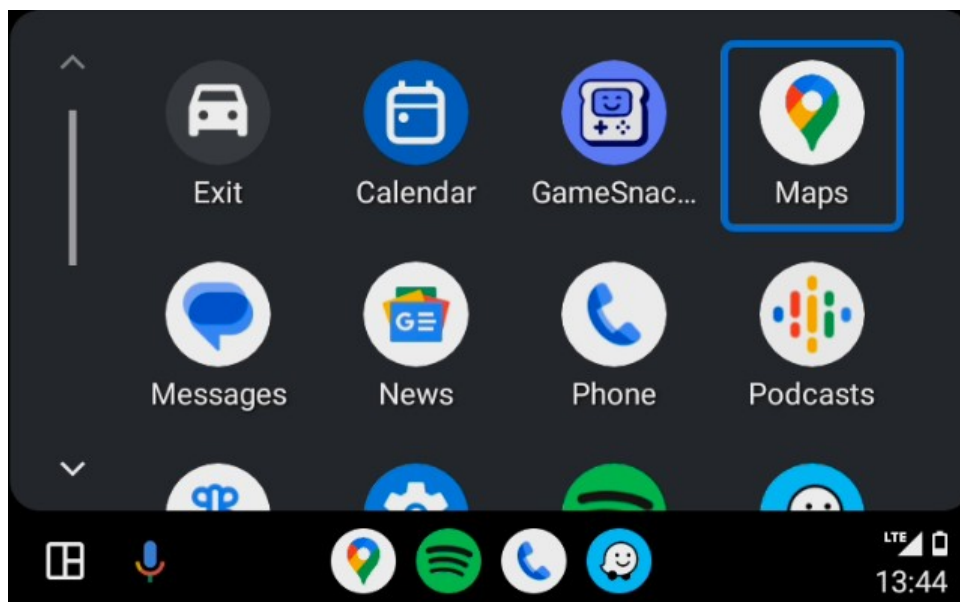

12. Make and answer a call

Confirm that the E6/E6-SE Bluetooth audio is connected to the mobile phone and the contacts is synchronized.

➤ Answer the call

When there is an incoming call on the mobile phone, the E6/E6-SE host displays the incoming call information. Press the OK key to answer the call, or press the Return key to reject the call. During the call, press the OK key to hang up the call.

You can also answer or hang up calls with voice commands. (see voice command description for details)

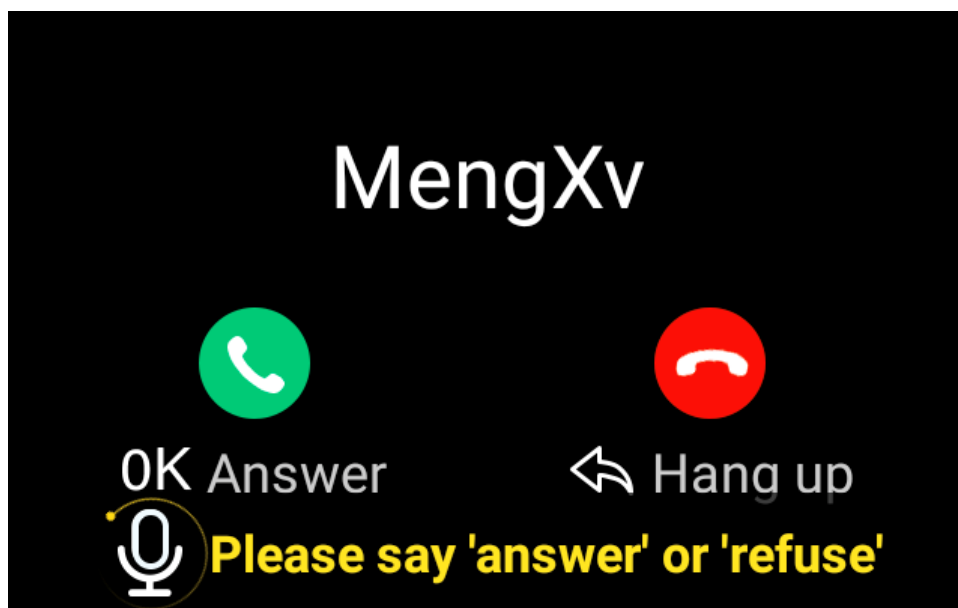



➤ **Make a call**

Method 1: Dial using mobile phone

Similar to using a traditional Bluetooth headset, dial the number on your mobile phone and use the E6/E6-SE to talk.

Method 2: Dial using the E6/E6-SE host contacts function

Select the Contacts on the E6/E6-SE host --> Select the "Contacts" tab --> Select the contact with the up and down keys --> Call the selected contact with the OK key.

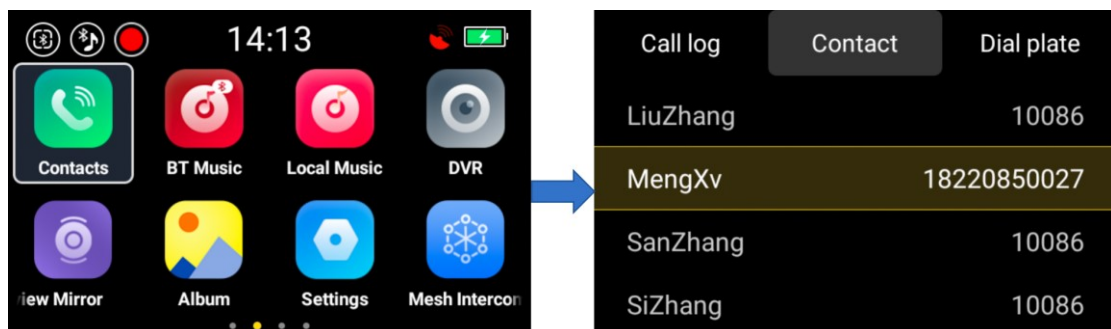

Method 4: Use the E6/E6-SE dial pad to enter numbers to dial

Select the Contacts on the E6/E6-SE host --> Select the "Dial" tab --> Enter the phone number --> Select the green dial button on the right to dial

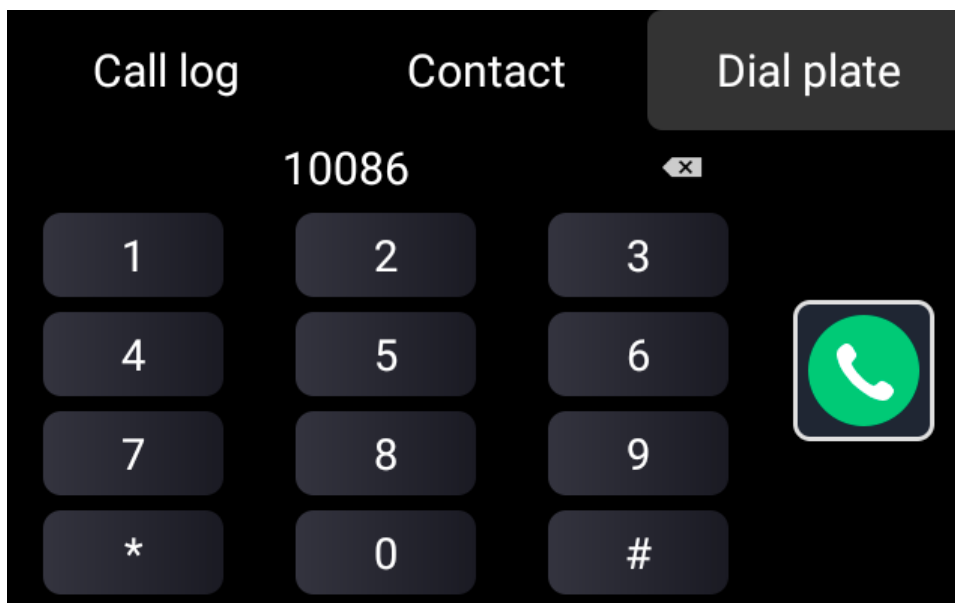

➤ **Switch the call to the background**

During a call, long press the return key to place the current call in the background.

➤ **Synchronize mobile phone contacts**

When the mobile phone connects to the E6/E6-SE host using Bluetooth audio, the following permission dialog box will pop up on the mobile phone (the permission dialog boxes of different brands of mobile phones may be slightly different). Click "Agree and Continue" and the phone will automatically synchronize the contacts to the E6/E6-SE host.

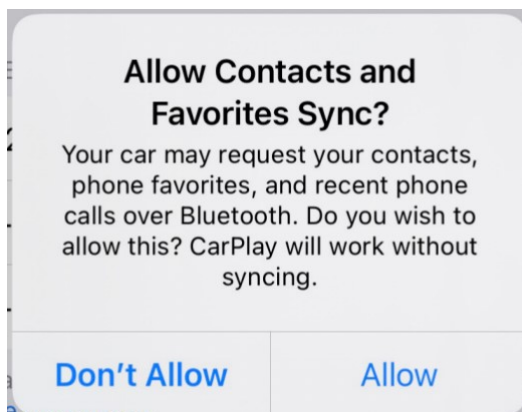

If you need to manually synchronize your address book, you can click "HUD Settings" --> "Synchronize contacts" after connecting the device in the MOTOEYE APP.

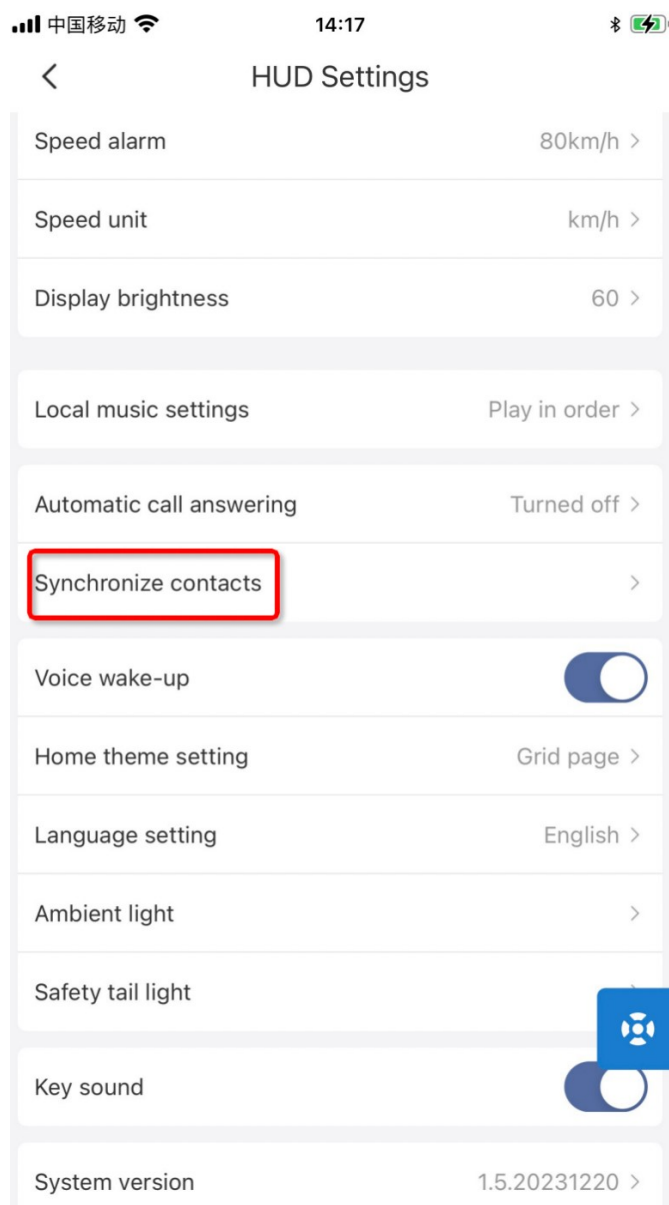

13. Music

➤ Play local music

E6/E6-SE host can play music in the TF card.

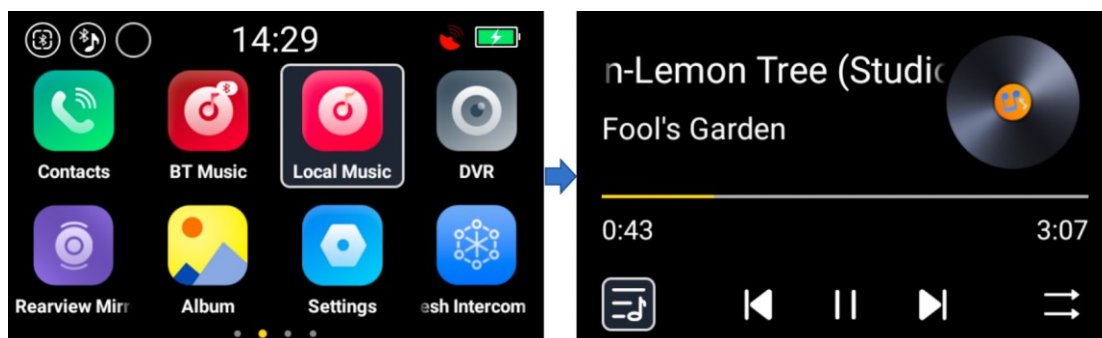

➤ Play Bluetooth music

After the E6/E6-SE host is connected to the mobile phone via Bluetooth, open the music player on your mobile phone, and play the music.

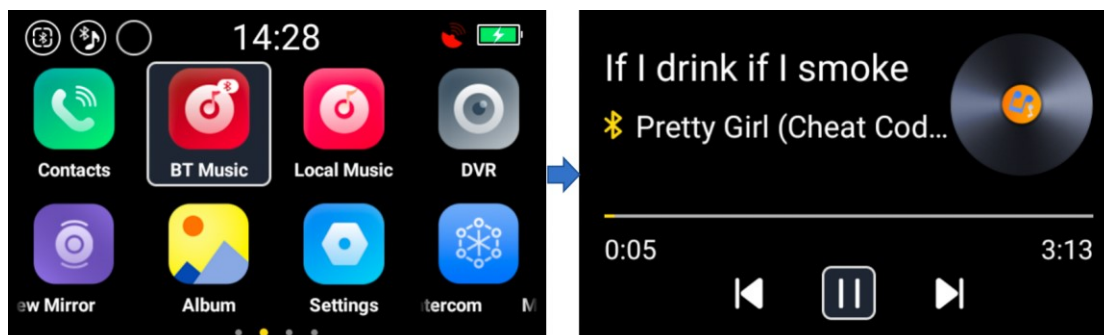

14. Take a photo

Select Camera APP on the E6/E6-SE --> Press OK to take a photo.

Notes:

The camera function can only be used after the host is connected to the front camera.

15. Driving Record

Select the DVR APP on the E6/E6-SE host --> Press OK to start/stop recording.

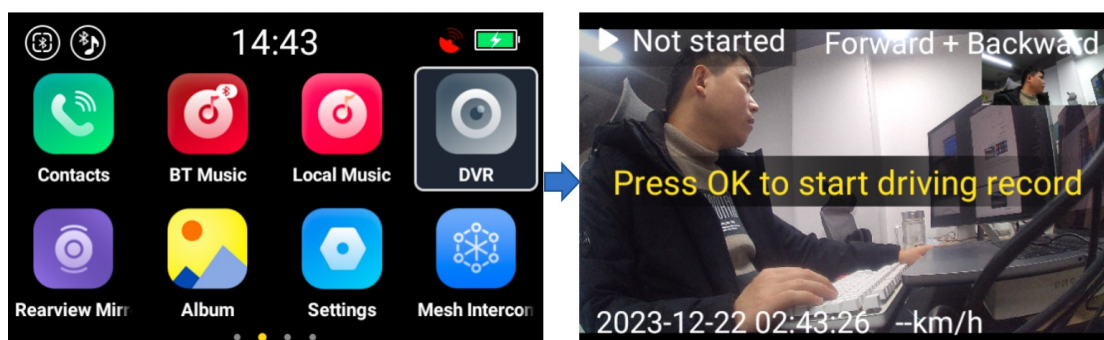

After turning on video recording, long press the return key to put the app in the background.

The resolution fps supported by the E6/E6-SE driving recording function

is: 1080p 30fps, 720p 30fps, which can be set in the settings function.

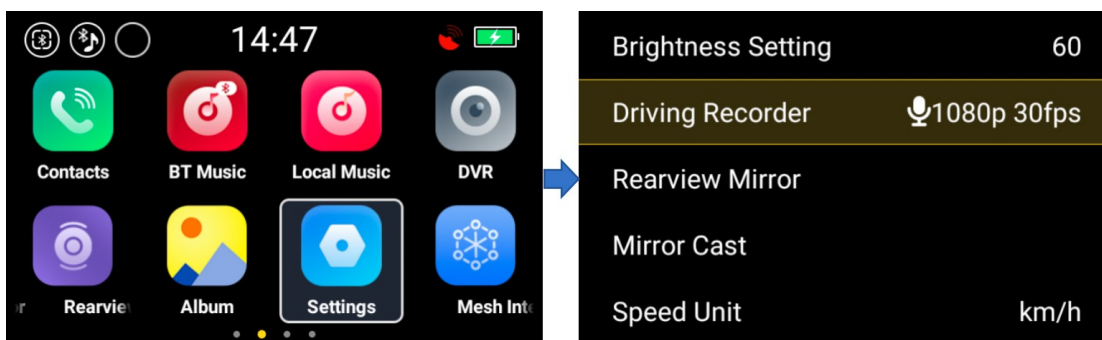

E6/E6-SE driving records support three durations, 1 minute, 3 minutes, and 5 minutes.

➤ **Setting record mode**

There are three recording modes for E6/E6-SE driving recording (the latter two modes are only supported when the extended front camera is connected):

Single camera recording: If there is a front camera, it will be the front camera picture, and it will be the rear camera picture.

Front camera + screen: A front camera must be installed.

Front camera + backward camera: A front camera and a rear camera must be installed.

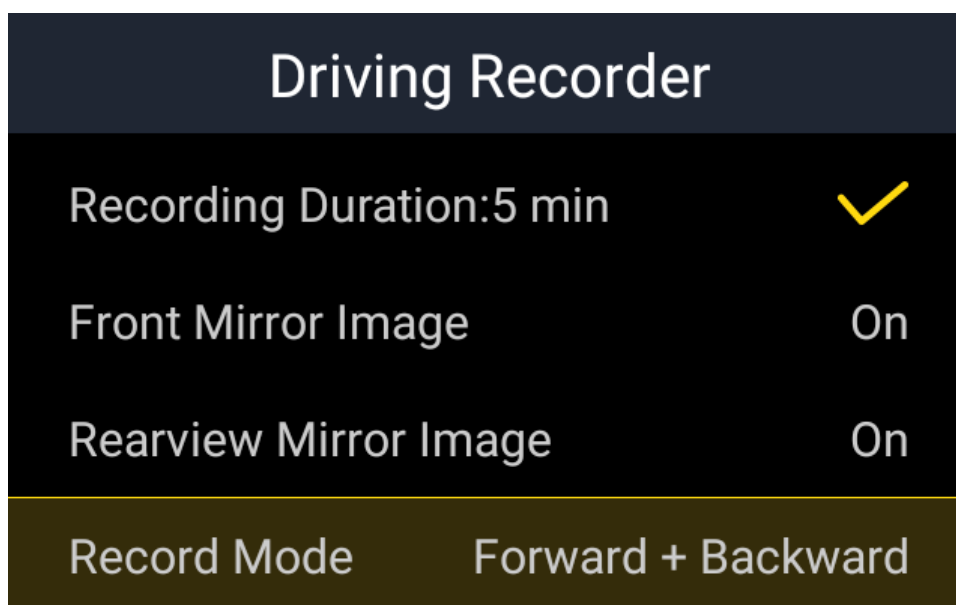

Set driving records in MOTOEYE APP

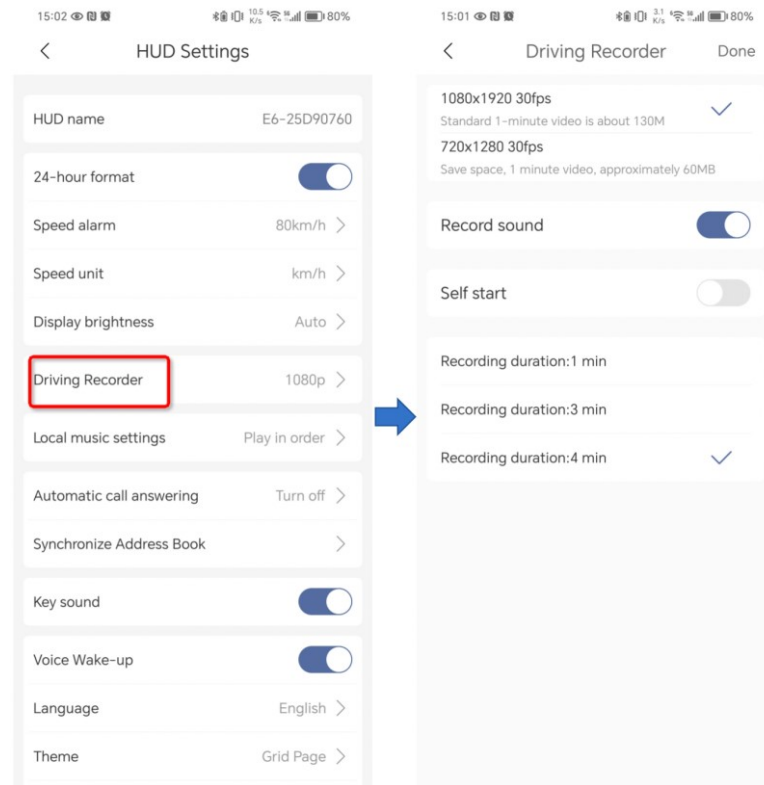

16. Voice command

Press and hold the OK button, or say "Moto Moto" to activate the voice assistant.

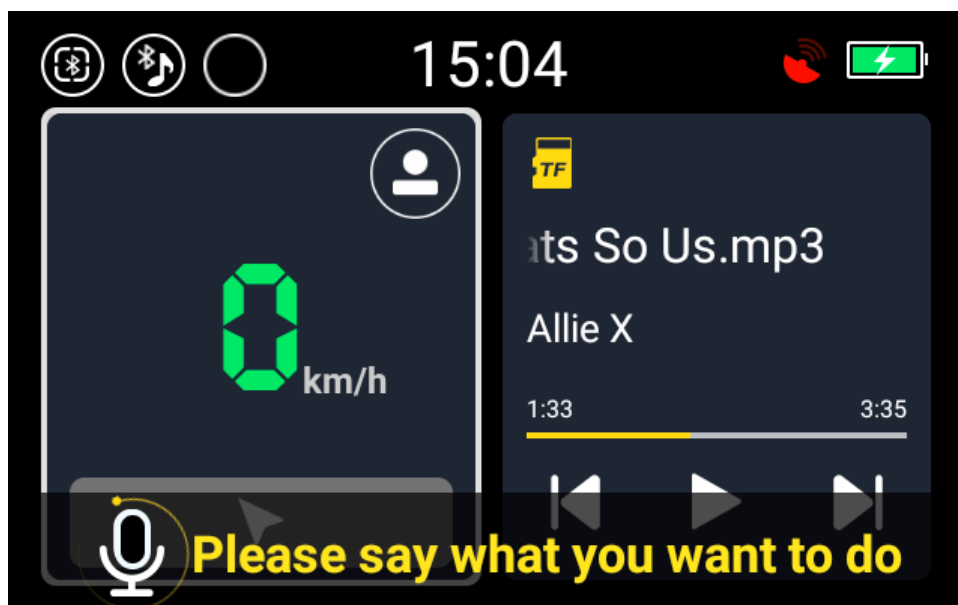

The "Moto Moto" voice wake-up function can be turned off in the HUD's "Settings" - "Voice Wake-up".

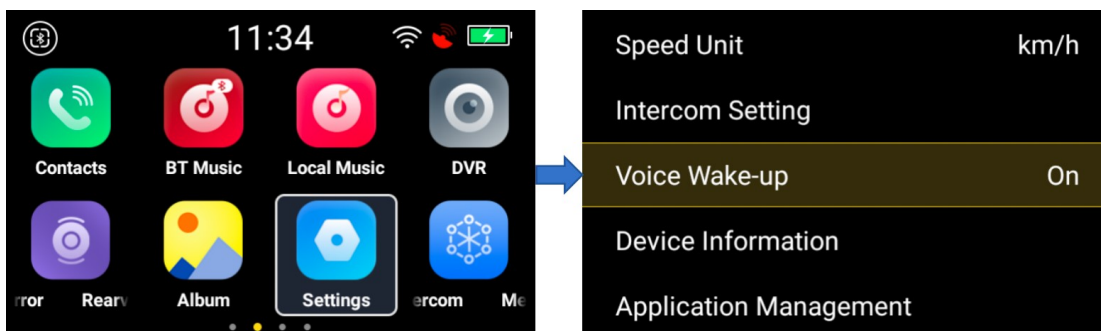

The voice commands are shown in the following table:

Functions	Voice command
Answer and reject	answer
	Ignore Reject
Play music	play music
	play Bluetooth music
	play local music
Pause music	Pause the music
Stop music	Stop the music
Previous track	Previous track
Next track	Next track
Increase brightness	increase brightness
Decrease brightness	decrease brightness
Increase volume	increase volume
Decrease volume	decrease volume
Open the camera	start xx
	xx can be camera
Take a photo	take a photo
Open and start driving recording	start xx
	xx can be DVR, recording
Stop driving recording	stop xx

	xx can be DVR、recording
Open and start intercom	start xx
	xx can be intercom、public intercom
Stop intercom	stop xx
	xx can be intercom、public intercom
Go to homepage	"Go to the home" "Back to home"
Wake up screen	wake up
Turn off screen	sleep
Move right	right
Move left	left
Move up	up
Move down	down
Confirm	OK
	confirm
Return	return
	back
Turn off voice command	cancel

17. Photo and video download

Photos and videos taken by the E6/E6-SE host can be downloaded to the mobile phone through the MOTOEYE APP. The download method is as follows:

Confirm that the MOTOEYE APP is connected to the E6/E6-SE host.

On the MOTOEYE APP homepage, select the HUD album --> Network settings -> select the WIFI with the network name "E6/E6-SE-xxxxxxx" and enter the password 12345678 to connect to the network.

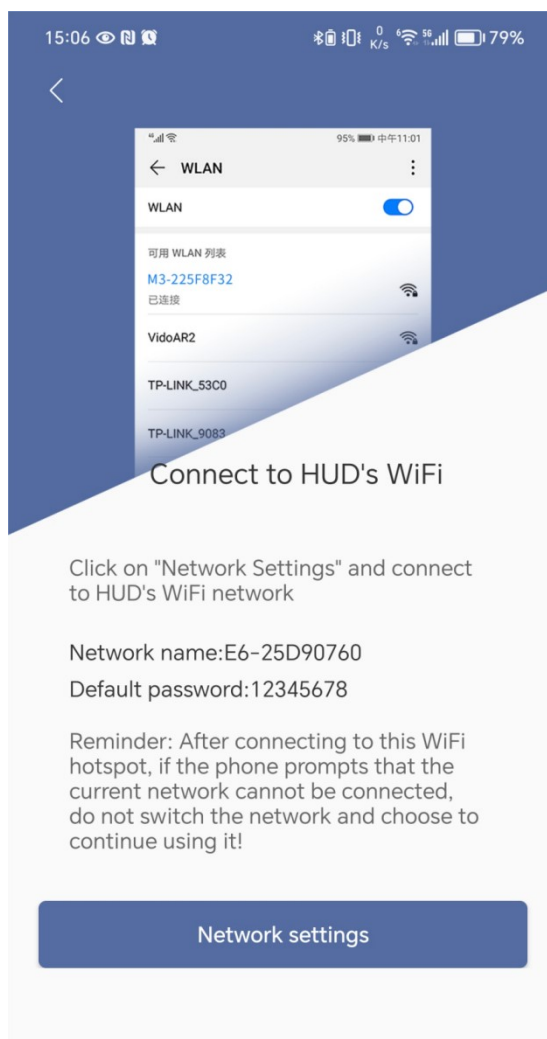
**Notes:**

If your phone prompts "The current network cannot connect to the Internet, do you want to switch networks?", please do not switch and choose to continue using it, after exiting the host album function, the phone will automatically disconnect from the hotspot connection with the E6/E6-SE host.

After the connection is successful, you can view, download, and delete photos and videos in the E6/E6-SE host in the mobile APP.

Notes:

In the "HUD Album" function of the mobile APP, deleting photos or videos will only delete the files in the E6/E6-SE memory card. Files that have been downloaded to the mobile phone will not be deleted. If you want to delete the files that have been downloaded to the mobile phone, The

files need to be deleted from the phone's file manager or photo album.

18. Public network intercom

The E6/E6-SE host and MOTOEYE APP support the network intercom function, which is a full-duplex intercom mode. When using the E6/E6-SE host or mobile APP for intercom, you need to use the MOTOEYE APP to create or join the intercom room first.

➤ Create intercom room

Select Team Intercom on the MOTOEYE APP homepage --> Create a team.

The user who creates the team is the team leader by default, and can disband the team, modify the team's name, and delete team members on the intercom settings page.

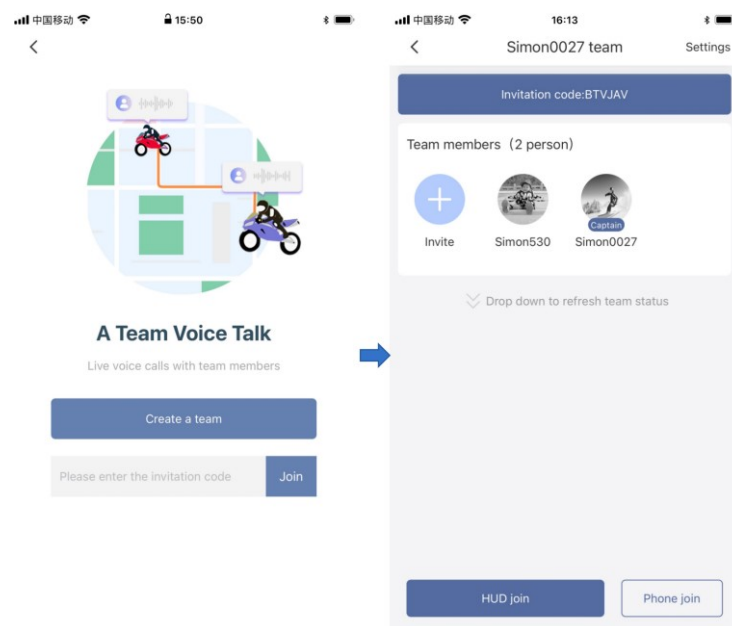

➤ Invite teammate

On the MOTOEYE APP my team page --> click on the invitation code --> select the third-party chat software to send the invitation code to teammates

➤ Join a team

Select Voice Talk on the MOTOEYE APP homepage --> Enter the invitation code and click to join

Users who join the team are ordinary members by default. They can exit the team on the intercom settings page. They cannot modify the team's name or delete team members.

➤ **Start intercom**

After creating or joining a team, users can see the information of the team they have joined on both the intercom page of the E6/E6-SE host and the intercom page of the mobile app. Users can use the E6/E6-SE host to intercom with teammates, or use the MOTOEYE mobile app to intercom with teammates.

Method 1: Using E6/E6-SE host for intercom

On the E6/E6-SE host, select public intercom ->press the OK key to turn on/off intercom.

Notes:

This feature requires online use.

On the intercom page, long press the return button to place the intercom application in the background.

Method 2: Using the MOTOEYE APP for intercom

Select Voice Talk on the MOTOEYE APP homepage ->click on mobile intercom ->join intercom

During the intercom process, click the "Mute" button to turn off/on your microphone, and click "Exit intercom" to turn off the intercom.

Notes:

For the first time joining the intercom, some phones need to follow the APP prompts to open the corresponding permissions.

During the intercom process, the homepage will display the number of people in the intercom room.

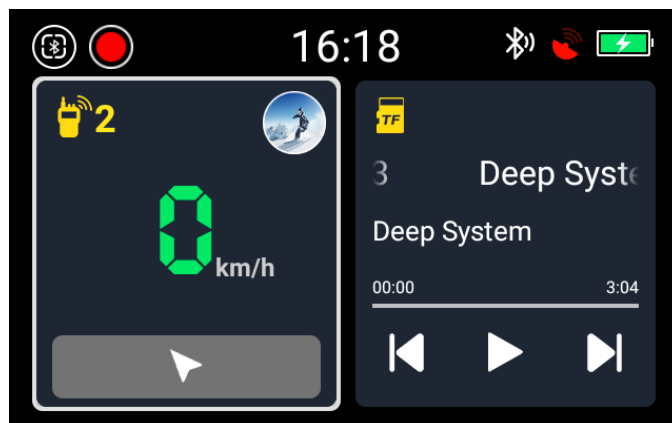

➤ Intercom settings

On the MOTOEYE APP homepage, select Voice Talk ->Settings ->Modify Team Name, Delete Team Members, and Dissolve Team

➤ Intercom Audio settings

During the intercom process, if you want to lower or mute other sounds, you can set them in the "Settings" - "intercom settings" section of the HUD to facilitate navigation or listening to music during the intercom process.

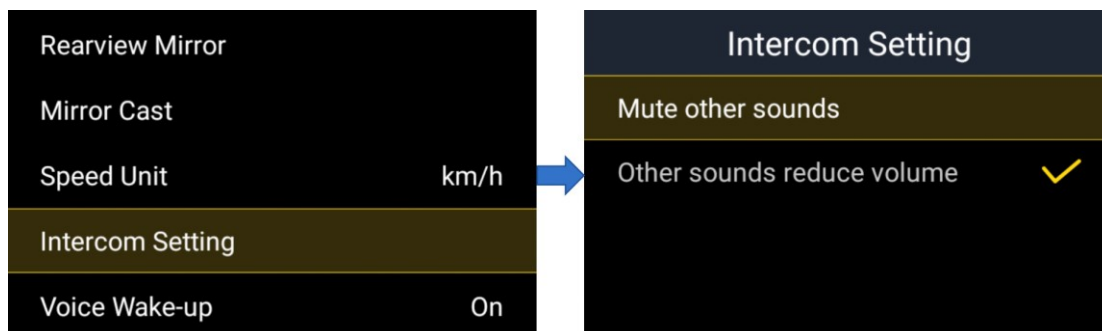

19. Mesh intercom

The E6/E6-SE host supports 9-person Mesh full duplex network intercom, using Mesh self-organizing network communication technology and dynamic network topology adjustment. It can communicate point-to-point at a distance of 800 meters, with a maximum communication distance of 5 kilometers for 9 people.

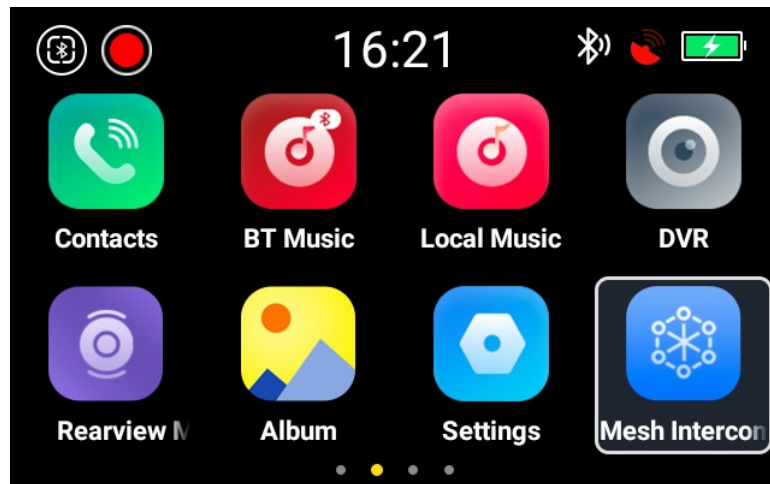

➤ **Intercom channel**

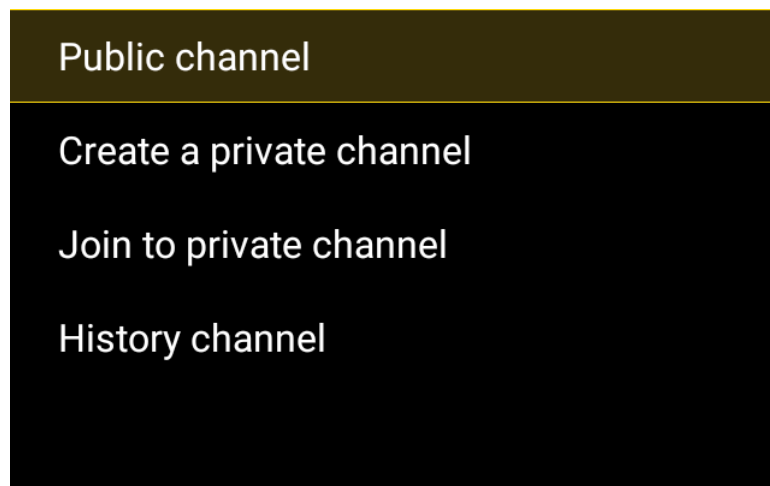

Mesh intercom can choose to use both public or private channels for networking.

➤ **Private channel**

“Creating a private channel” will generate a channel ID, which other members of the team can use to join the private channel.

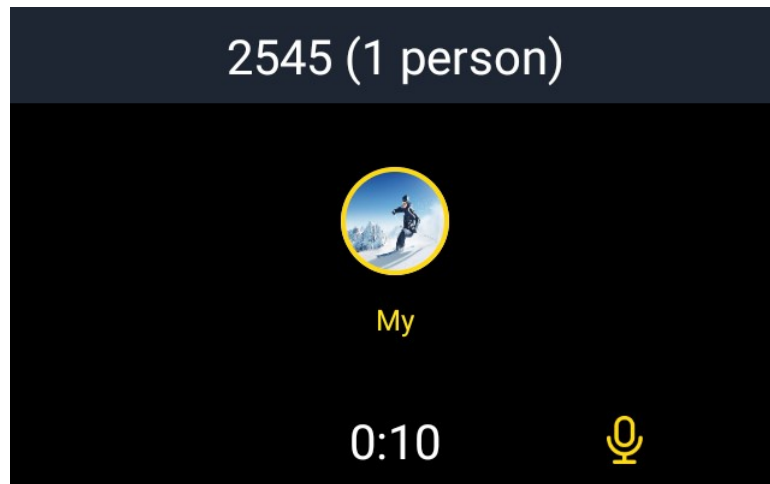

To join a private channel, you need to enter the channel ID and then click the "Join" button in the bottom right corner.

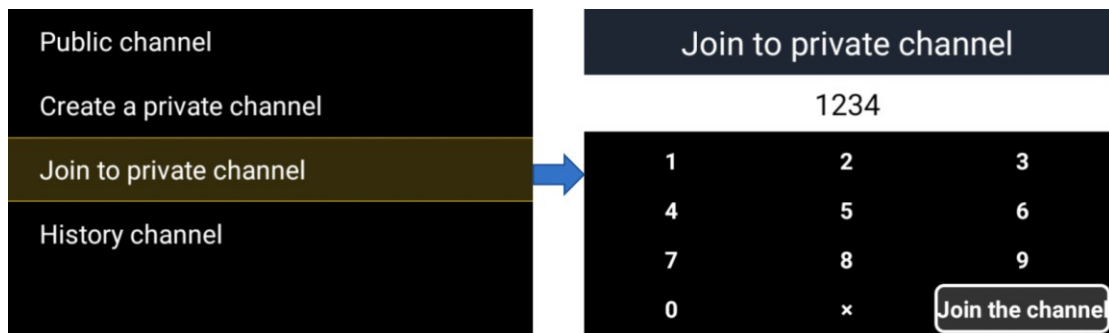

➤ Public channel

The system provides 10 public channels available by default, and users can join without password, making networking more convenient.

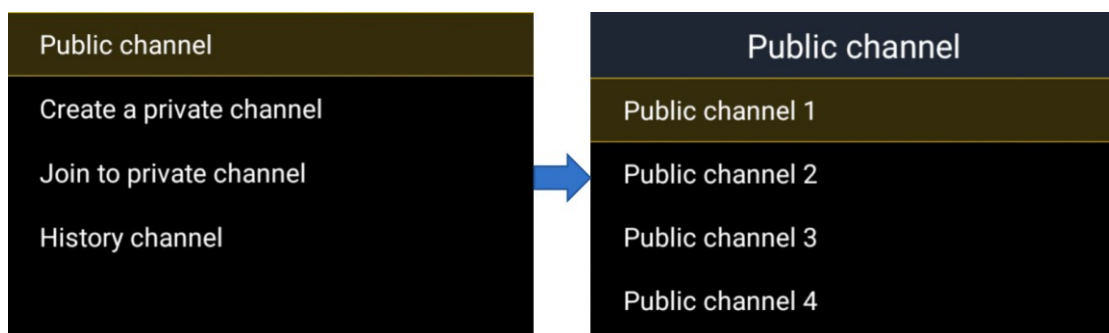

20. Apple CarPlay

➤ Manual connection

(1) Open the "CarPlay" function on the HUD device, and the interface will pop up the Bluetooth name of the host "E6-xxxxxxx" (without the

suffix "LE"), stay on this interface.

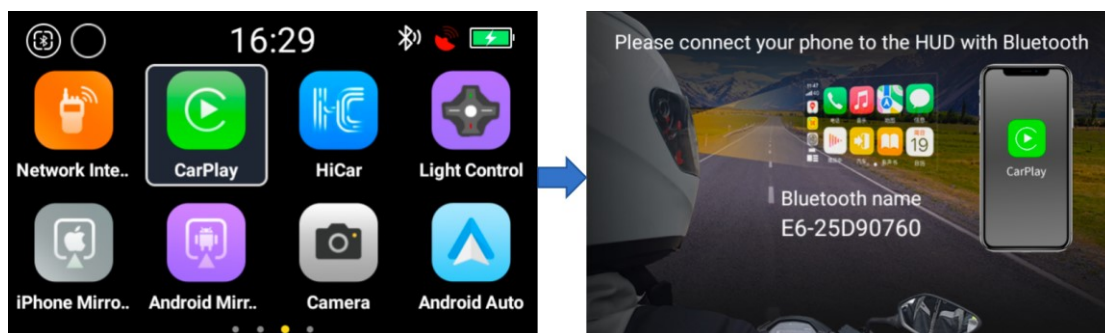

(2) After turning on WiFi on the iPhone, search for Bluetooth audio devices with the above names in "Settings" - "Bluetooth" (without the suffix "LE"), then click on connect.

(3) At this point, an animation of "Connecting, please wait..." will appear on the HUD end, and a few seconds later, a dialog box of "Using CarPlay?" will appear on the mobile phone.

(4) Click "Using CarPlay" on the mobile phone, and CarPlay will complete the connection in about 10 seconds. The HUD screen will display the CarPlay interface.

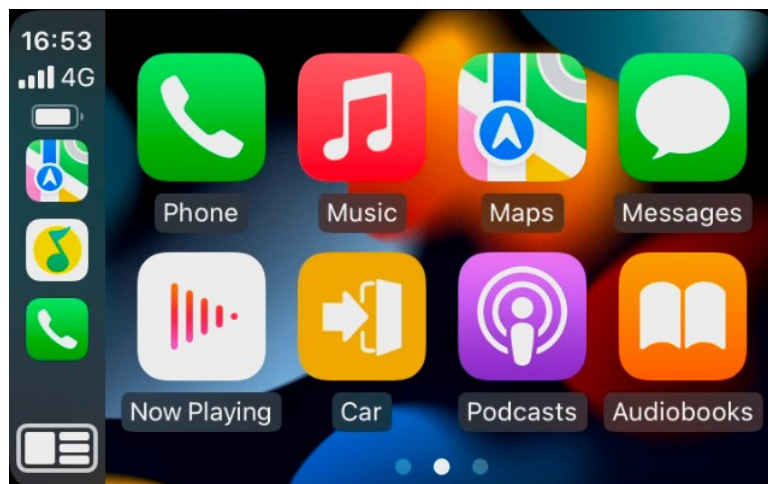

➤ Set CarPlay to automatically connect

(1) Open the "Settings" - "Mirror Cast" function on the HUD device and select the "Allow background connections" option.

(2) After setting, if HUD detects the Bluetooth audio connection of the iPhone, it will automatically establish a CarPlay connection.

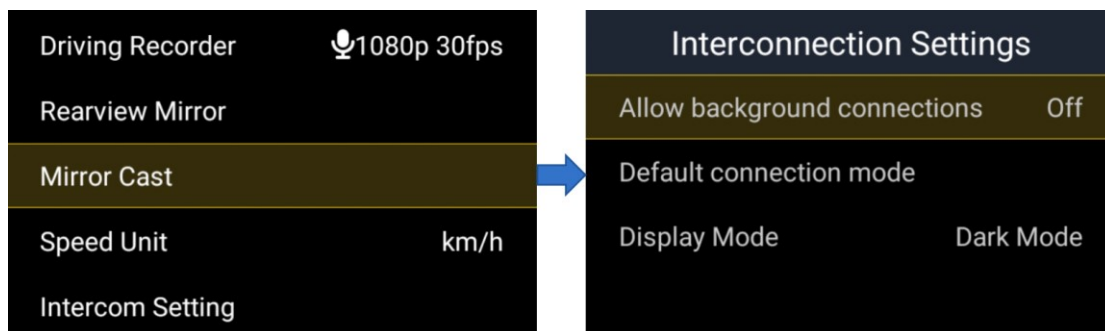

➤ Disconnect CarPlay

- (1) Turn on or off the WiFi switch once on the mobile (recommended).
- (2) Ignoring the Bluetooth device in the "System" - "Bluetooth" section on the mobile phone (not recommended).

➤ CarPlay operation:

- (1) On the CarPlay interface, you can operate the function menu through the Bluetooth controller. Long press the up and down buttons to adjust the volume.
- (2) On the CarPlay interface, you can wake up Siri of your iPhone by long pressing the "OK" button or saying "Hi, Siri" via voice. (Siri function needs to be enabled on the mobile phone).
- (3) In the CarPlay interface, by clicking on the "Car" icon on the main interface, you can return to the HUD's native system, or long press the return button to return to the HUD's "dashboard interface". If you need to return to CarPlay again, you can click on the "CarPlay" APP in the HUD's local system to enter.
- (4) To set the background of CarPlay, you can do so in the "Settings" - "Wallpaper" section of CarPlay. Setting the background to pure black provides a better experience.

➤ CarPlay navigation

- (1) CarPlay supports mainstream navigation software such as Google

Maps.

(2) Set the destination on the mobile phone and depart, and the corresponding navigation interface will be automatically displayed on the HUD.

➤ **CarPlay music**

(1) CarPlay Support mainstream music software such as Apple Music.

(2) You can open the corresponding music software on your phone or HUD to play music.

21. Huawei HiCar

➤ **HiCar Connection**

(1) Open the "HiCar" function on the HUD device, and the interface will pop up the host Bluetooth name "E6 xxxxxxxx" (without "LE" at the end), stay on this interface.

(2) After enabling WiFi on Huawei mobile devices, search for the Bluetooth device with the above name in "Settings" - "Bluetooth" and click on "Connect".

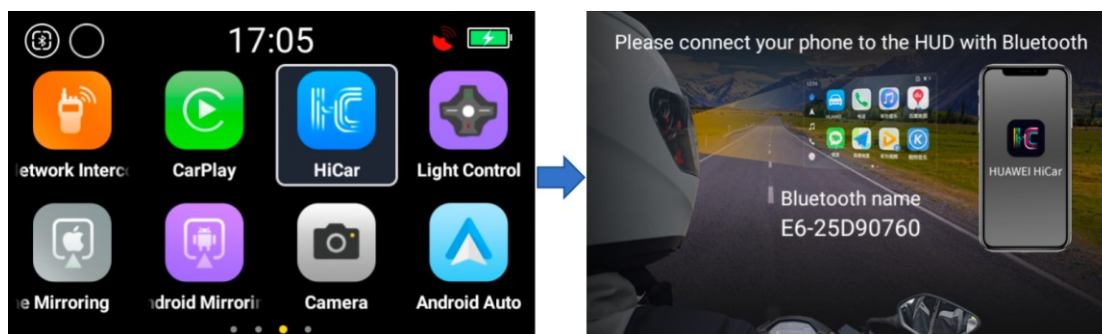

(3) After connecting Huawei phones to Bluetooth, a HiCar connection code will appear on the HUD interface, and a connection prompt box will automatically pop up on the phone.

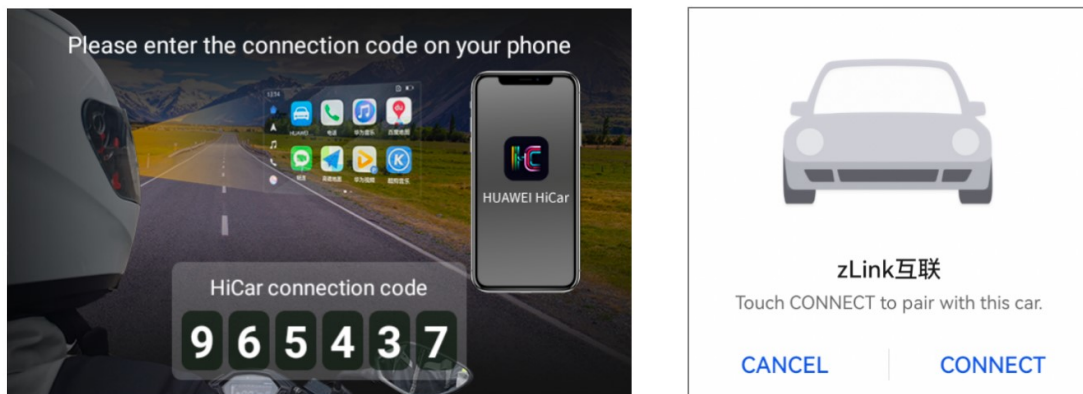

(4) Enter the HiCar connection code displayed on the HUD on the mobile phone and click "OK".

(5) Wait for about 3 seconds, HiCar will complete the connection, and the HUD screen will display the HiCar interface.

➤ Disconnect HiCar

Turn off the WiFi switch on the mobile phone to disconnect HiCar.

➤ HiCar Operation

(1) On the HiCar interface, the function menu can be operated through the Bluetooth controller. Long press the up and down buttons to adjust the volume.

(2) On the HiCar interface, long press the "OK" button to wake up the voice assistant on Huawei phones. (Need to activate the voice assistant function of the phone in advance).

(3) In the HiCar interface, click the "Application" icon in the upper left corner to switch between the split screen panel and the application list.

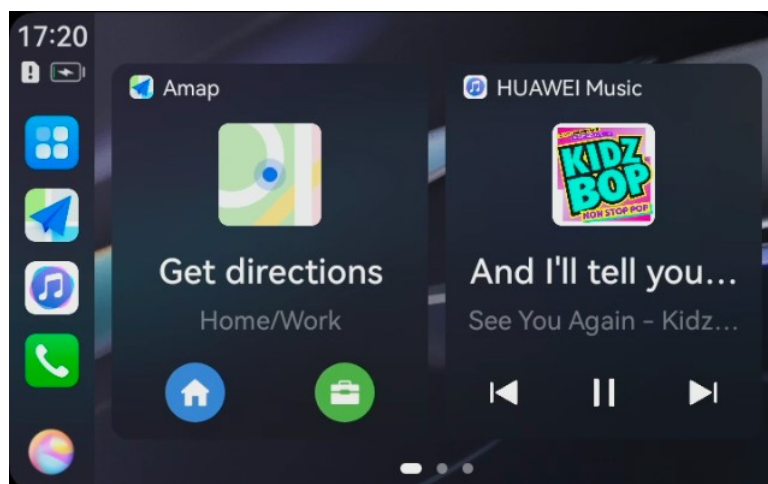

(4) In the HiCar interface, you can return to the HUD's native system by clicking on the "zLink" icon on the main interface, or long press the return button to return to the HUD's "dashboard interface". If you need to return to HiCar again, you can click on the "HiCar" in the HUD's local system to enter.



➤ HiCar navigation

(1) HiCar supports mainstream navigation software such as Amap and Baidu Maps.

(2) Open the navigation software on the mobile and set the destination on the mobile.

(3) Open the corresponding navigation software on the HUD, and the navigation interface will automatically switch from the phone screen to the HUD.

(4) Due to Huawei's ecological limitations, HiCar navigation only

supports car routes.

➤ **HiCar music**

(1) HiCar supports mainstream music software such as Kugou Music.

(2) You can open the corresponding music software on your phone or HUD to play music.

22. Android Auto

➤ **Connect Android Auto**

(1) Open the "Android Auto" function on the HUD device, and the interface will pop up the Bluetooth name of the host "E6-xxxxxxx" (without the suffix "LE"), stay on this interface.

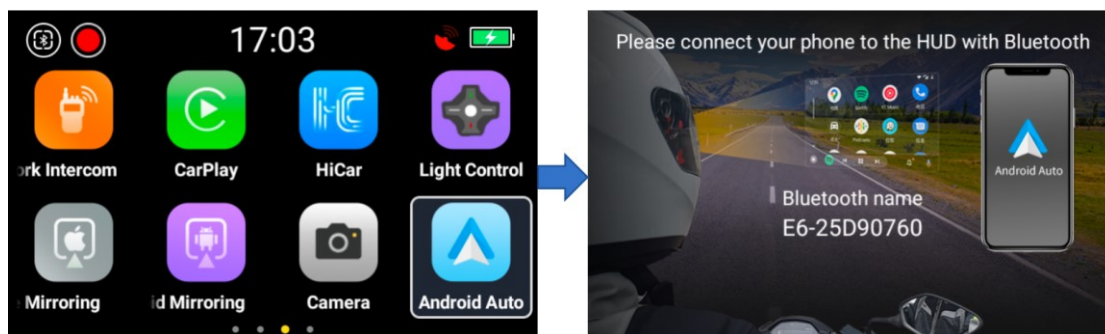

(2) After turning on WiFi on the Android phone, search for the Bluetooth audio device with the above name in "Settings" - "Bluetooth" (the suffix does not include "LE"), And click on connect.

(3) Wait for about 3 seconds, Android Auto will complete the connection, and the HUD screen will display the interface of Android Auto.

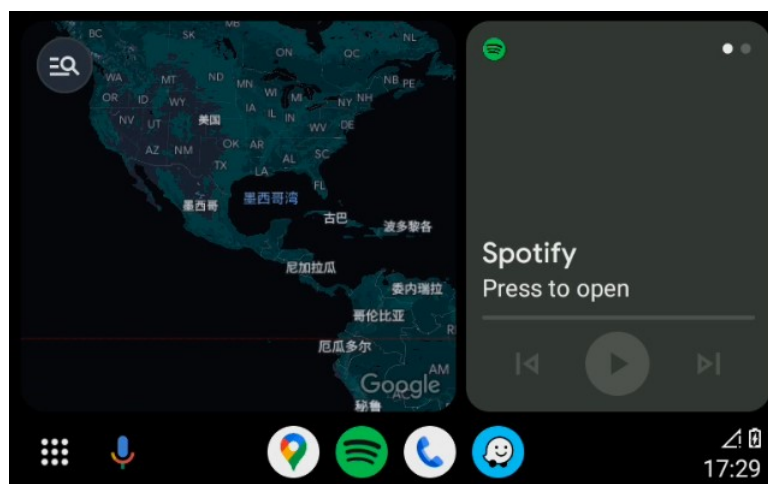

➤ Disconnect Android Auto

Turn off both WiFi and Bluetooth switches on the mobile to disconnect Android Auto.

➤ Android Auto operation

(1) In the Android Auto interface, you can operate the function menu through the remote control. Long press the up and down buttons to adjust the volume.

(2) You can switch between the Launcher card and the bottom application icon by pressing the up and down keys. Pressing the left and right keys can switch the focus inside the Launcher card, and long pressing the left and right keys can switch between different Launcher cards.

(3) On the Android Auto interface, long press the "OK" button to wake up the voice assistant on the Android phone. (Need to activate the voice assistant function of the phone in advance).

(4) In the Android Auto interface, click the "Layout" icon in the bottom left corner to switch between the split screen panel and the application list.

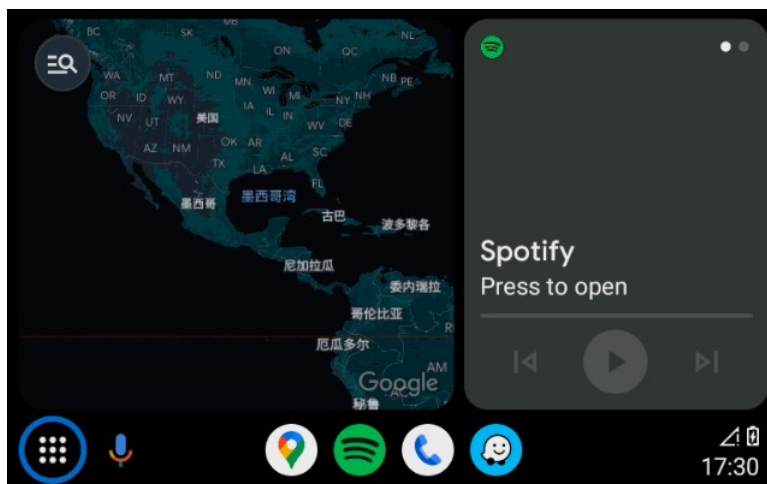

(5) In the Android Auto interface, you can return to the HUD's native system by clicking on the "Car" icon on the main interface, or long press the return button to return to the HUD's "Instrument Panel Interface". If you need to return to Android Auto again, you can click on the "Android Auto" on the HUD's local system to enter.

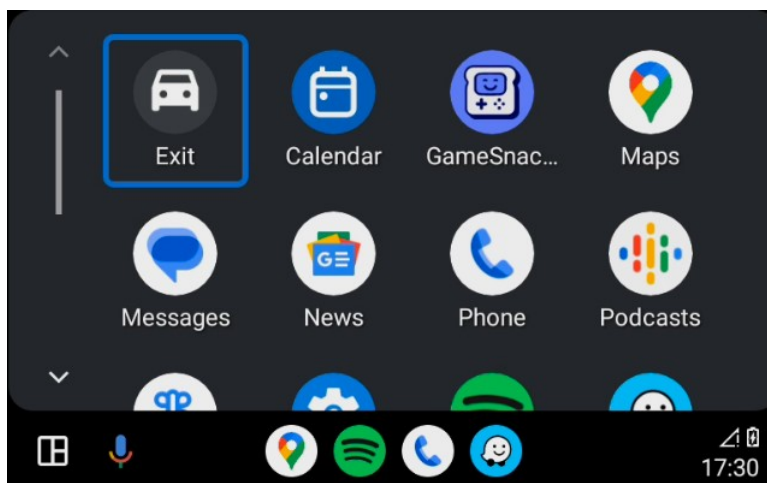

➤ Android Auto navigation

- (1) Android Auto supports software such as Google Maps.
- (2) Open the navigation software on the mobile and set the destination on the mobile end.
- (3) Open the corresponding navigation software on the HUD, and the navigation interface will automatically switch from the phone screen to the HUD.

➤ Android Auto music

- (1) Android Auto supports music software such as Spotify.
- (2) You can open the corresponding music software on your phone or HUD to play music.

23. Mobile screen mirroring

<1> iOS screen mirroring

➤ Connection

- (1) Open the "iOS screen mirroring" function on the HUD device and stay on this interface.
- (2) Open hotspots on your iPhone.
- (3) HUD connect to the hotspot of the iPhone.
- (4) In the mobile control center, first select "screen mirroring", then select "zj-airplay" to connect.

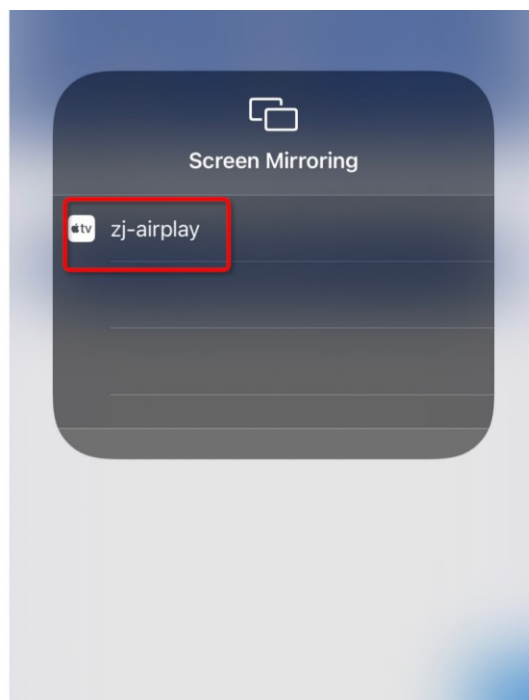
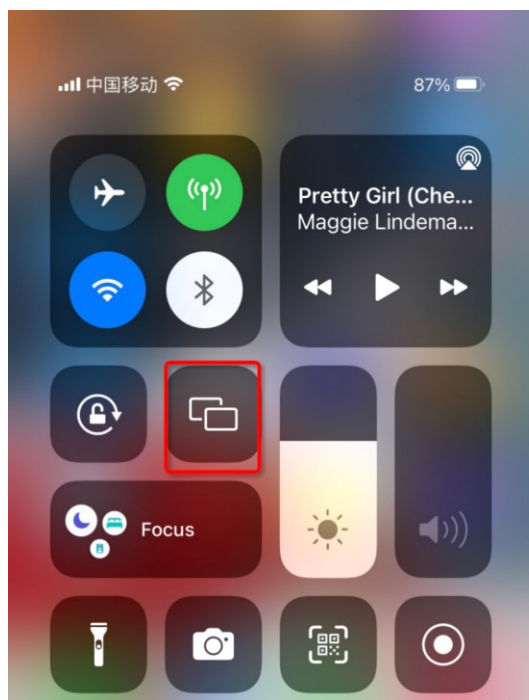

➤ Notes

- (1) When using the mobile screen mirroring function, the phone must be in a bright screen state.

(2) The horizontal and vertical screen status displayed on the HUD is consistent with the status of the mobile application.

(3) When encountering problems such as slow screen mirroring connection speed or insufficient smooth screen mirroring, the following actions can be attempted:

1. Open "Settings" on your phone ->enter the "Personal Hotspot" page.
2. Find the "Maximum Compatibility" option and ensure that it is turned off.



<2> Android screen mirroring

➤ Download android mirroring APP

Android phones need to download and install the "ZhiJia" mirroring APP.
Scan the QR code below to download.



ZhiJia



➤ Connection

(1) Open the "Android screen mirroring" function on the HUD device and stay on this interface.

(2) Open hotspots on your android phone.

(3) HUD connect to the hotspot of the phone.

(4) Open the "ZhiJia" app on your phone and click "Start mirroring".

➤ 注意事项

(1) When using the mobile screen mirroring function, the phone must be in a bright screen state.

(2) The horizontal and vertical screen status displayed on the HUD is consistent with the status of the mobile application.

(3) When encountering problems such as slow screen mirroring connection speed or insufficient smooth screen mirroring, the following actions can be attempted:

1. Open "Settings" on your phone ->enter the "Personal Hotspot" page.

2. Set the hotspot to 5GHz.

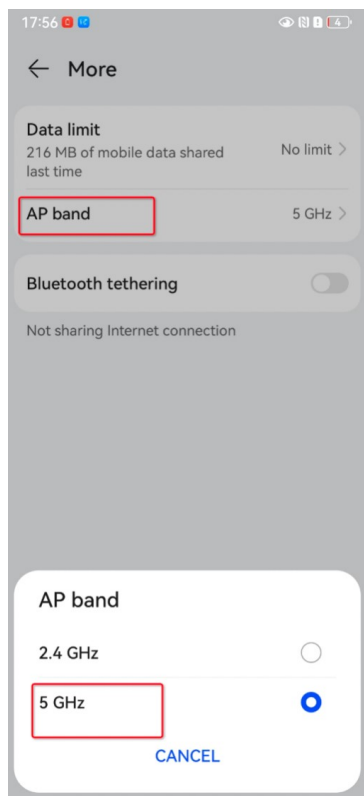

24. Light effect settings

The "Light Effect Settings" in the HUD host can be used to set the flashing lights and ambient lights.

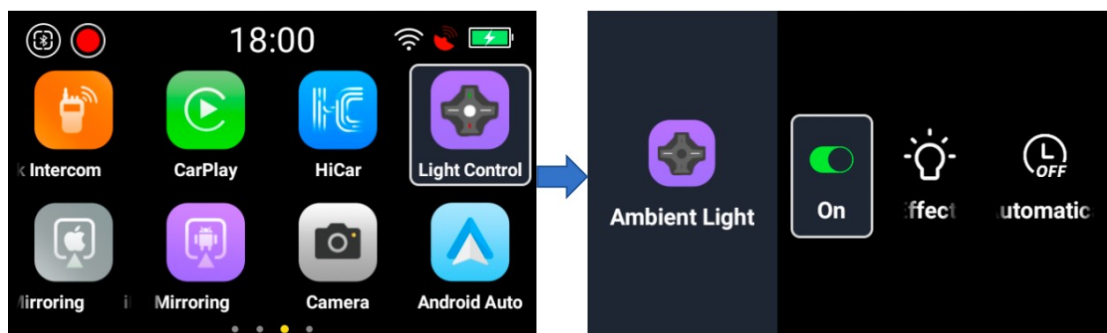

The E6 device does not have a flash tail light, so this interface only displays the setting of the ambient light.

➤ Ambient light settings

Switch: The ambient light can be turned on or off.

Atmosphere light effect settings: including 6 modes: "Always on",

"Colorful breath ", "Colorful flowing", "Lights follow sound A", " Lights follow sound B" and " Lights follow sound C".

Auto start setting: There are two modes for automatic start: "Automatic opening at the dark" and "Open and close regularly".

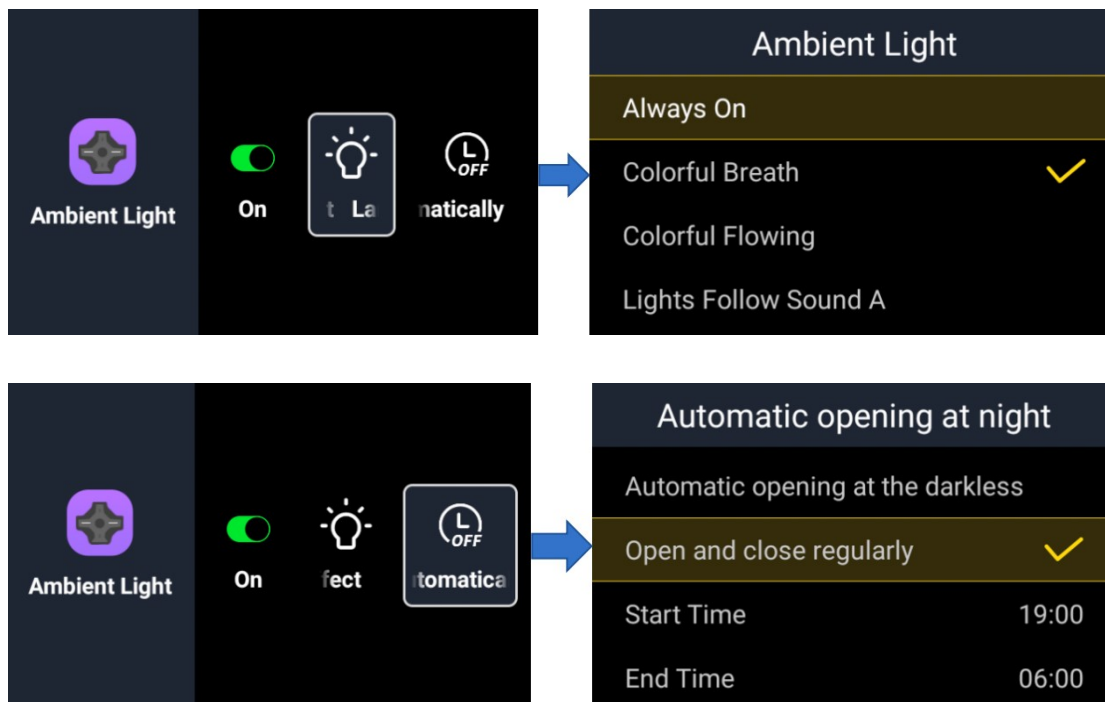

➤ Flash tail light settings

Switch: The ambient light can be turned on or off.

Flash light effect setting: includes 5 modes: "Warning light mode 1", "Warning light mode 2", "Navigation light mode", "Breathing mode", and " Lights follow sound".

Auto start setting: There are two modes for automatic start: "Auto start when low light" and "Timed on and off".

The settings of lights can also be set in the MOTOEYE APP.

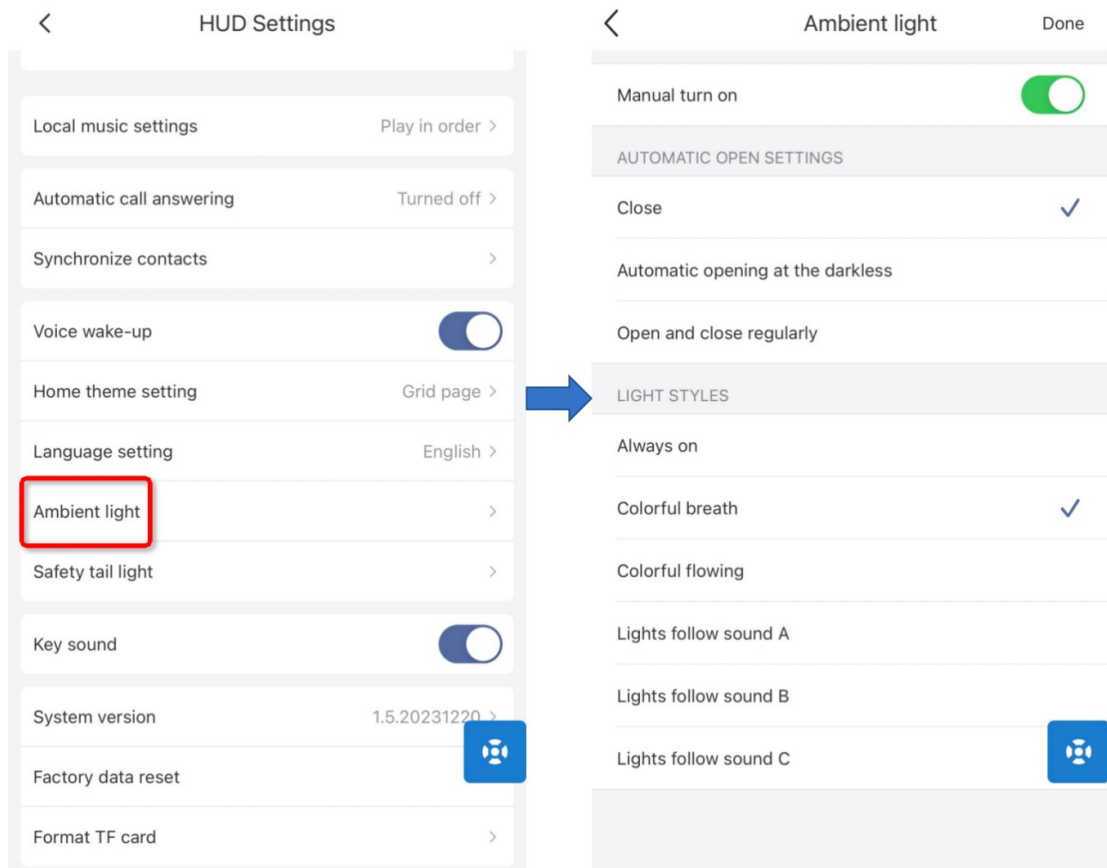

25. HUD settings

- ✓ Method 1: Use E6/E6-SE host settings

Enter settings on the E6/E6-SE host -->Select the desired settings to set.

- ✓ Method 2: Use MOTOEYE APP settings

Confirm that the MOTOEYE APP is connected to the E6/E6-SE host

On the MOTOEYE APP homepage, select HUD Settings ->Select the desired settings to set.

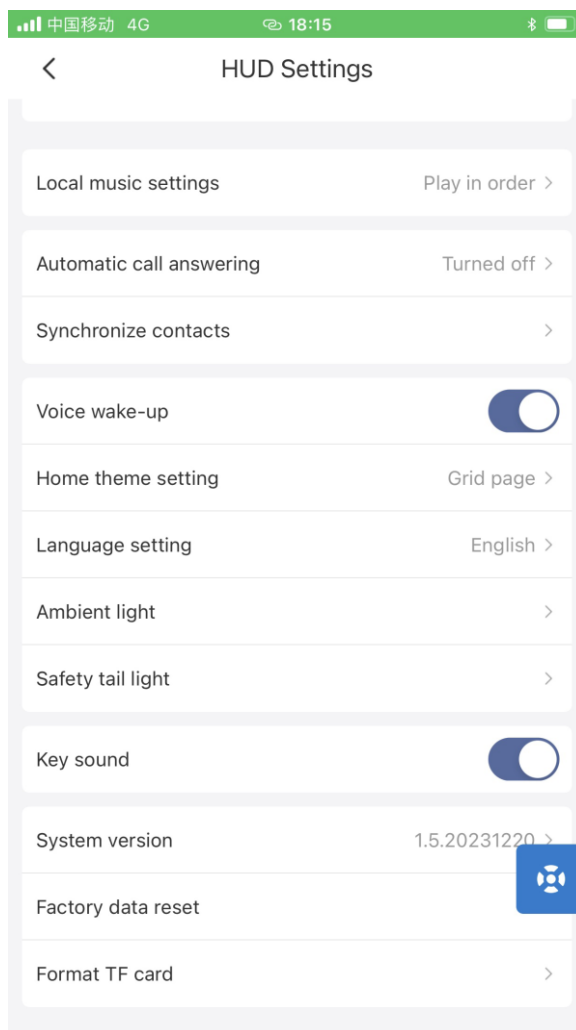

The settings supported by E6/E6-SE host and MOTOEYE APP are as follows:

(√: support ×: not support)

Setting item	E6/E6-SE host	MOTOEYE APP
24-hour format	×	√
Speed alarm	×	√
Speed unit	√	√
Display brightness	√	√
Local music settings	√	√
Photo quality	√	√
Video quality	√	√
Driving recorder	√	√
Automatic call answering	×	√

Synchronize contacts	×	√
Key sound	×	√
Device information	√	√
Version detection	√	√
Voice wake-up	√	√
UI style	√	√
Language setting	√	√
Ambient light	√	√
Flash tail light	√	√
Restore factory setting	√	√
TF card format	√	√

26. Restore factory setting

Method 1: Use MOTOEYE APP

First connect the MOTOEYE APP to the E6/E6-SE host. Click on "Restore Factory Setting" in the "HUD Settings" on the App, and click "Confirm" in the pop-up confirmation box. At this time, the display module of the HUD will display a prompt box for reconfirmation. Click the confirm button on the host, and the system will automatically restore the factory setting. Restoring factory setting will take about 1 minute.

Method 2: Use HUD host

Open the "Settings" function of the HUD host and select "Restore Factory Setting".

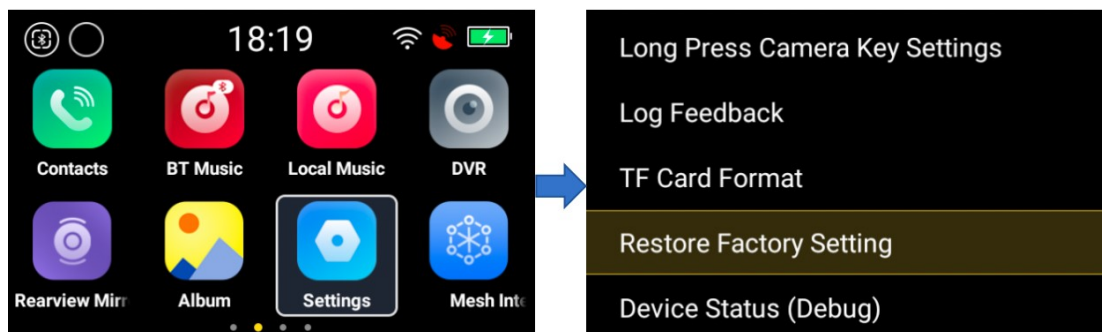

27. TF card formatting and file management

➤ TF card formatting:

Method 1: Use MOTOEYE APP

Open the MOTOEYE APP and enter "HUD Settings", select "Format TF Card".

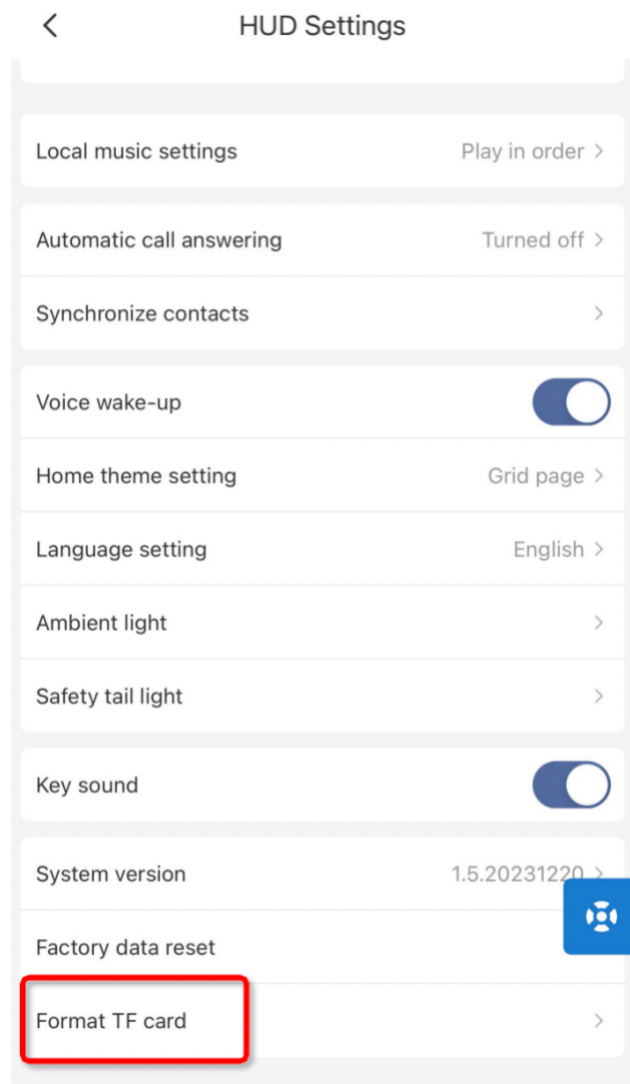

Method 2: Use HUD host

Open the "Settings" of the HUD host and select "Format Storage Card".

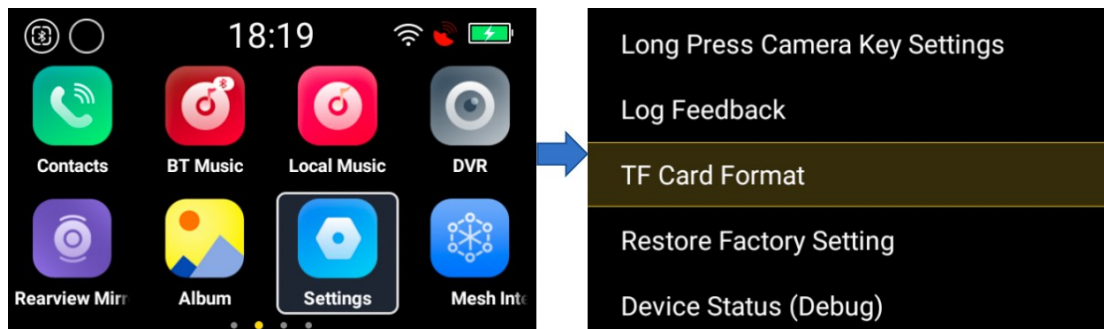

➤ TF card file management method:

✓ Method 1: Using the MOTOEYE app to connect to the E6/E6-SE host, you can download photos, videos from the E6/E6-SE host to your phone. For detailed instructions on how to use them, please refer to the "Download Photos and Videos" section.

✓ Method 2: After the host is turned on, connect it to the computer using a TypeC data cable, and a "MOTOEYE E6/E6-SE" disk will appear on the computer. Opening this disk allows you to operate the files in the TF card.

✓ Method 3: Remove the TF card from the E6/E6-SE host and use a universal TF card reader for operation.

The E6/E6-SE host supports a maximum of 256GB TF card. To ensure high frame rate recording quality, please use a UHS Speed Class TF card with U1 specification. We recommend using the following brands of TF cards:

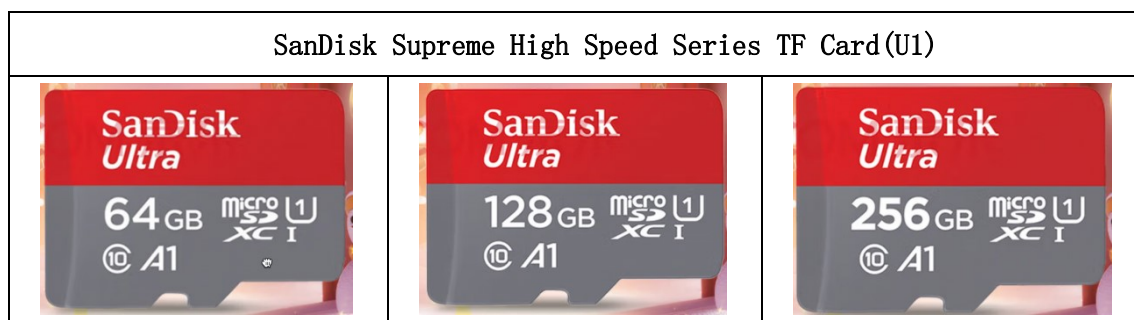

28. Firmware upgrade

➤ OTA online upgrade

Before upgrading, ensure that the E6/E6-SE is connected to the network. It is recommended to perform a firmware upgrade in a WIFI environment.

In the "Settings" - "Version Detection" section of the E6/E6-SE host or in the "HUD Settings" - "System Version" section of the MOTOEYE app, if prompted with the latest firmware version, users can click the OK button to download and upgrade the firmware.

During the firmware upgrade process, the host may restart several times. Please do not intervene manually. The firmware download and upgrade process may take about 5 minutes.

➤ Offline upgrade

Click on "System Version" in the "Settings" menu of the E6/E6-SE host or in the "HUD Settings" section of the MOTOEYE app. If prompted with the latest firmware version, users can upgrade the firmware of the E6/E6-SE host using the following methods.

(1) Download the latest version of firmware from the official website.

(2) After downloading, copy the firmware (in the format of update_xxxxxxx.zip) file to the root directory of the host TF card.

(3) Disconnect the USB connection between the computer and the host, restart the host, and the system will automatically upgrade the firmware. During the firmware upgrade process, the host may restart several times. Please do not intervene manually, the firmware upgrade may take about 1-2 minutes.

Notes:

Please ensure that the battery level of the E6/E6-SE host is above 50% during firmware upgrade.

IV. Remote controller usage

1. Install remote controller

(1) Rotate the controller counter-clockwise to remove it from the base.

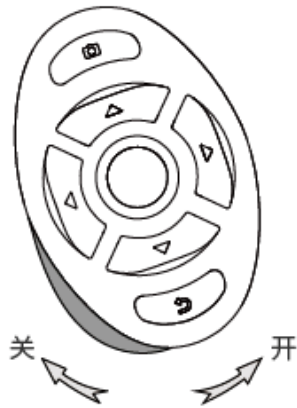

(2) Use a wrench to install the controller base onto the bracket and attach the back glue to the arc position of the bracket.

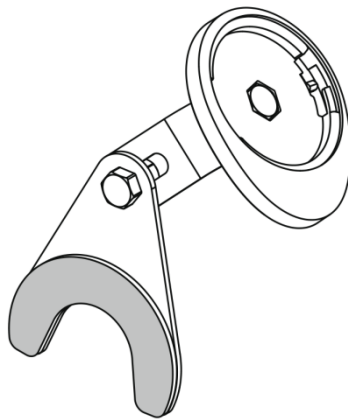

(3) Remove the release paper from the bracket, paste the assembled bracket onto the handlebar, and press to ensure reliable installation.

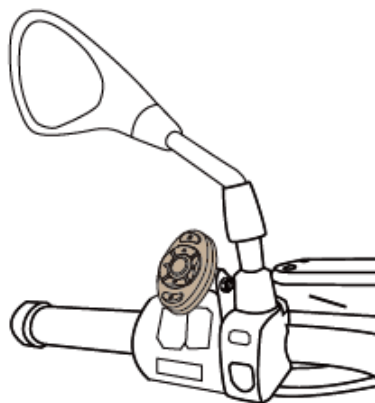

2. Replace the battery

If need to replace the battery, you can use a coin to open the battery cover and replace the battery. The battery model is CR2032.

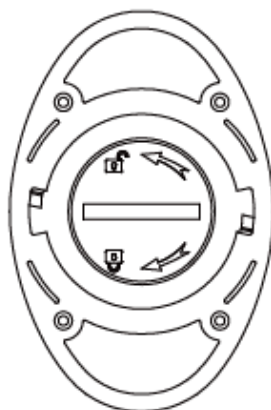

3. Pairing and connection

After the HUD is turned on, press any key on the remote controller and wait for a few seconds. The controller can resume connection to the HUD. After the HUD shuts down, the remote controller will automatically enter low-power sleep mode.

If you need to pair the Bluetooth remote controller again, you can proceed as follows:

(1) Press and hold the camera button and return button of the controller simultaneously for more than 3 seconds. At this time, the red and blue lights on the remote control flash alternately.

(2) After establishing a Bluetooth connection between the MOTOEYE APP and the HUD host, click the controller button on the APP homepage or "Device Connection" page.

(3) Click on "Search Bluetooth Controller".

(4) Select the Bluetooth controller to connect to.

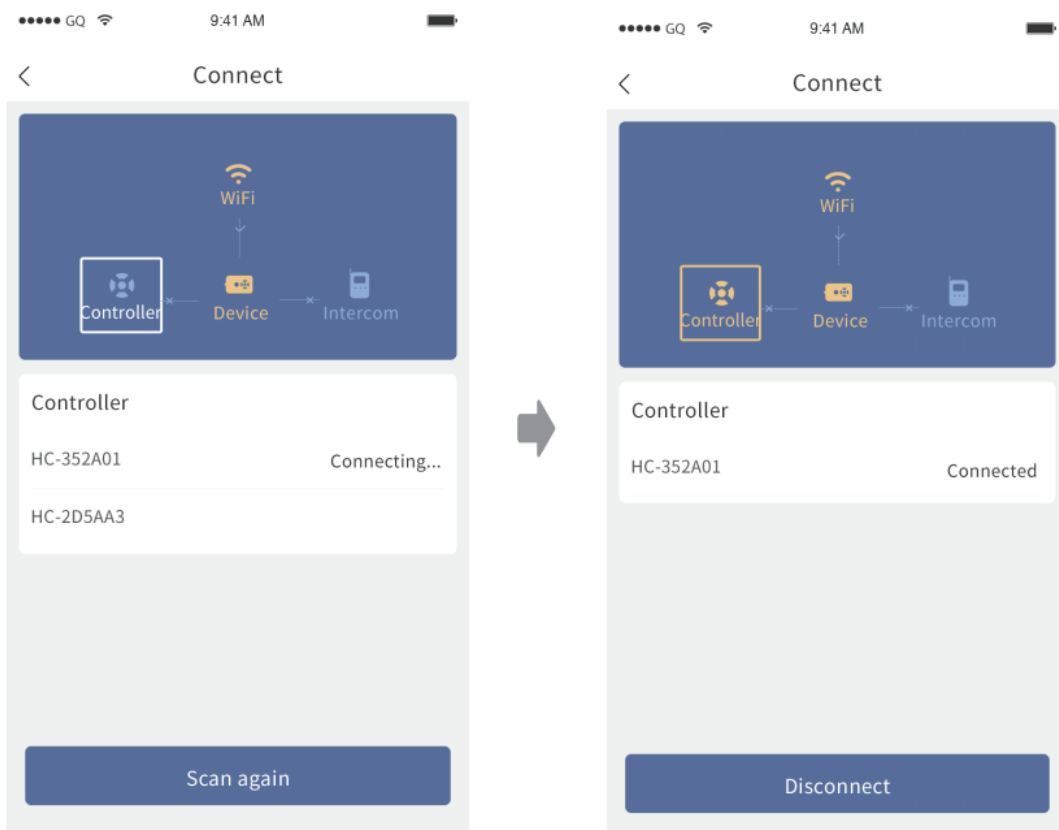

V. Safety tips

1. When using, the display module should be adjusted to a position that is above the human eye. The correct installation standard is that when the human eye looks ahead, the display module does not obstruct the field of view. Slightly lifting the eye and using residual light can easily see the complete image of the display module.
2. HUD is used to display driving assistance information. Long term viewing is prohibited while cycling. Please avoid watching HUD for long periods of time or watching videos while cycling to avoid personal danger.
3. The information provided by HUD navigation and rearview camera is for your reference only. Please do not use it as the sole basis for your travel. Please refer to the actual traffic and road conditions and comply with traffic laws and regulations.
4. During installation, please keep the display module inside the silicone sleeve. The prism of the display module is made of resin material, and collision may cause damage, which is not covered by the warranty.
5. During installation, the display module cable and headphone cable should not be excessively pulled, and appropriate space should be reserved for the outlet position, otherwise it may cause cable damage.
6. After the installation of the display module, its position can be adjusted through the connected hose, which can only be adjusted slightly and the rotation adjustment cannot exceed 30 degrees, otherwise it may cause irreversible damage to the hose.
7. To meet the waterproof design requirements, the plug is tightly fitted with

silicone. During installation, it is important to ensure that the plug is fully inserted to avoid affecting the normal function.

8.The host supports IP66 waterproof, while the display module is not waterproof. The display module is a precision optical device that can affect its imaging effect and lifespan when exposed to water. Please close the helmet mask for use on rainy days

9.After touching the display module by hand, leaving sweat stains may cause image ghosting. You can use an alcohol cotton pad or cotton cloth dipped in eyeglass cleaning agent for a slight wipe.

VI. FAQ

1. E6/E6-SE host or MOTOEYE APP cannot find Bluetooth controller

Solution:

(1) Please unbind the Bluetooth controller first. The unbinding method is to simultaneously press the camera button and return button on the controller for more than 3 seconds, and then search for the connection again.

(2) Please replace the controller battery. Please refer to the "Remote Controller Usage" for the replacement method.

2. The display module does not display the screen

Solution:

(1) Please first confirm whether the green indicator light of the E6/E6-SE host remains on. If it does not light up, it indicates that the device has not been turned on.

(2) Confirm whether the host is sleep, short press the power button to let the system standby/wake up.

(3) Ensure reliable installation of the host and the display cable, and restart the HUD host.

3. The MOTOEYE APP shows that the E6/E6-SE host has been connected, but the E6/E6-SE device cannot hear the Bluetooth audio of the phone.

Solution:

Bluetooth includes Bluetooth BLE connection and Bluetooth audio connection. The MOTOEYE APP only displays the BLE data connection between the phone and the host. Please search for and connect a Bluetooth audio device named "E6/E6-SE-xxx" in the "System Settings" - "Bluetooth Settings" of the phone.

4. After updating the contact list on the phone, the updated contacts cannot

be seen on the E6/E6-SE host

Solution:

After the Bluetooth audio connection between the phone and the host, if the contacts on the phone are manually updated, the host will update the contact list the next time when it connects to the phone. If you need to manually update the contact list, you can manually synchronize the phone's contact list in the MOTOEYE mobile APP - "Host Settings" - "Sync Contact List".