

Art.no 481-02
FIRST USE

STEP 1.

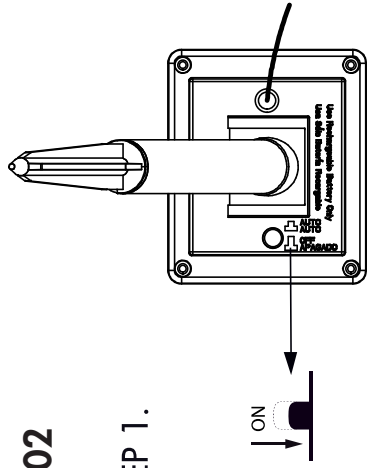

STEP 2.

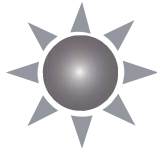

ON



OFF



Ready after
36 h in the sun

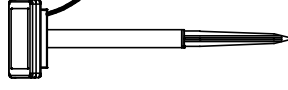

BATTERY REPLACEMENT

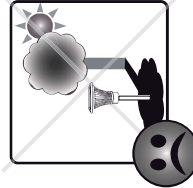
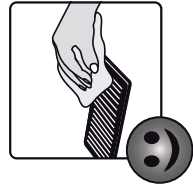
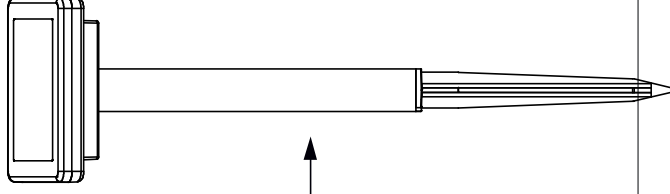
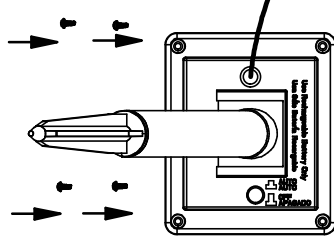
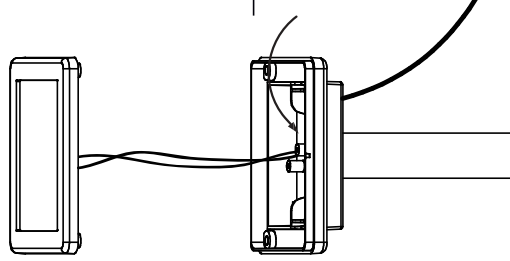
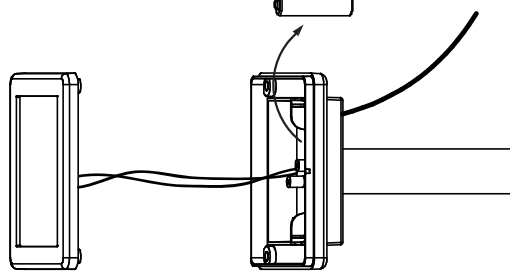
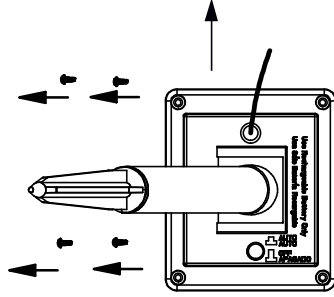
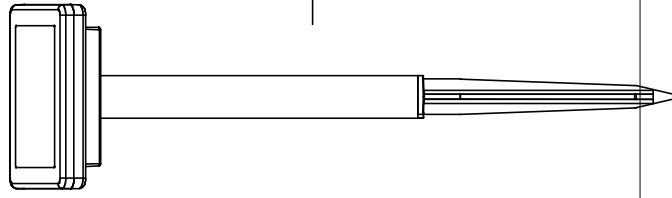

STAR
TRADING
STAR STREET 1
512 50 SVENLJUNGA
SWEDEN
www.startrading.com