





duplo



10931

LEGO.com/DUPL0

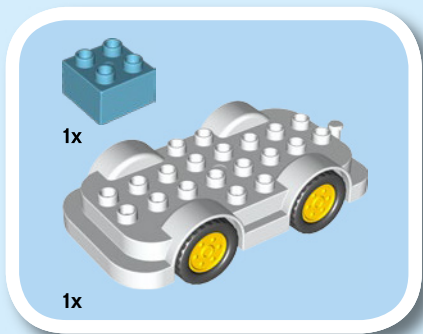



1

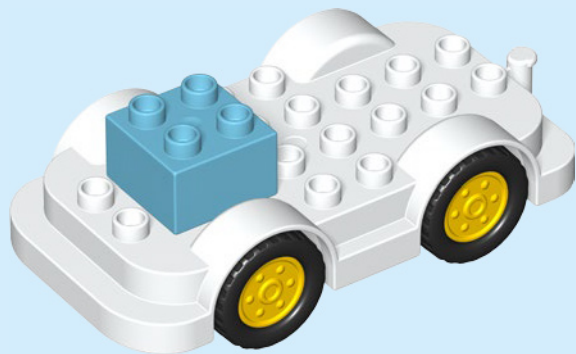

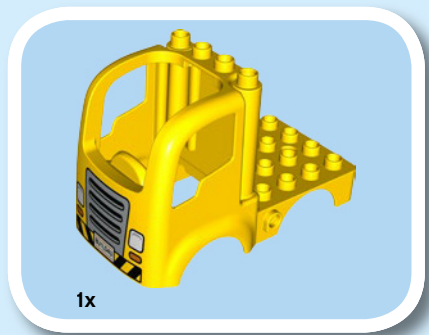

2



4

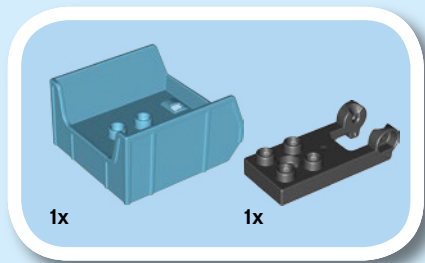

3

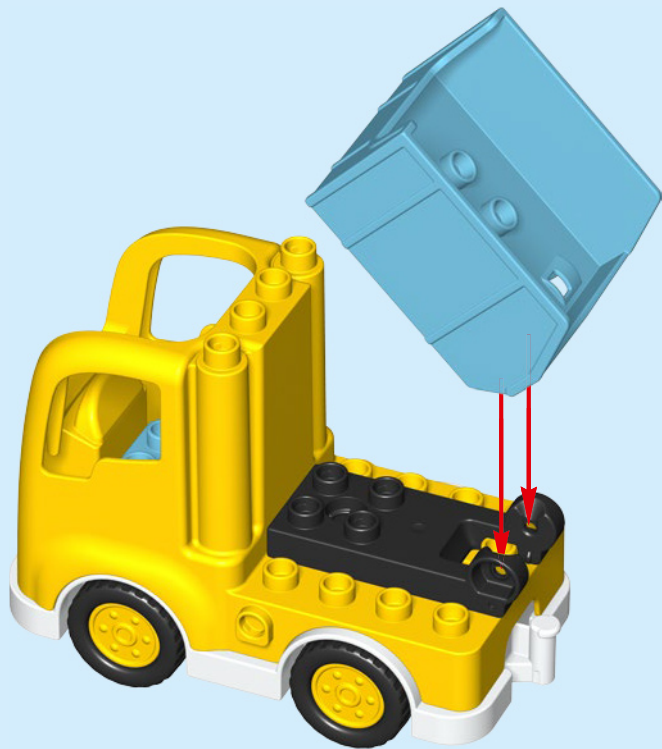

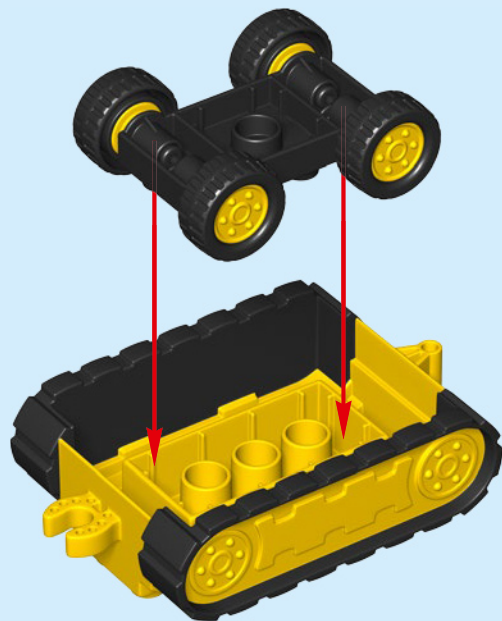
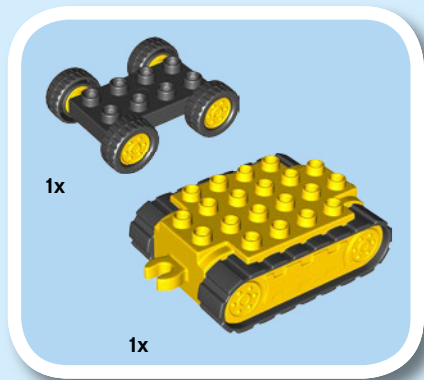

1

6

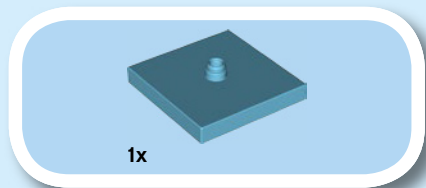

2

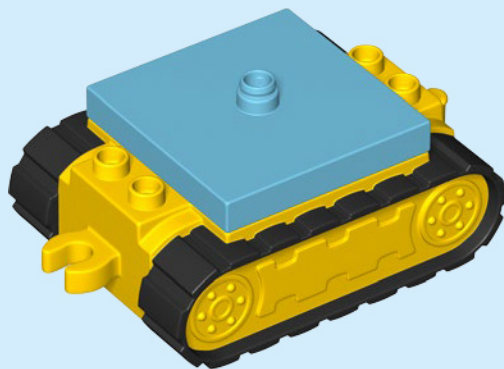



3

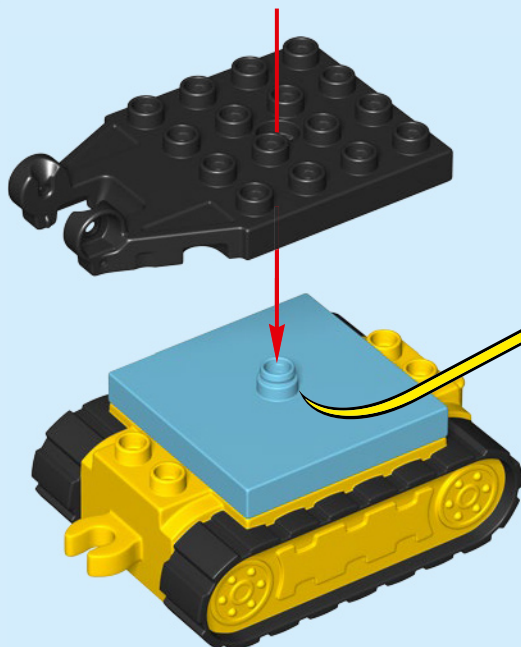

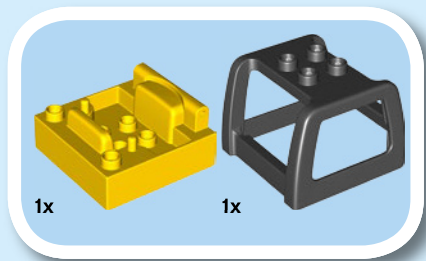

4

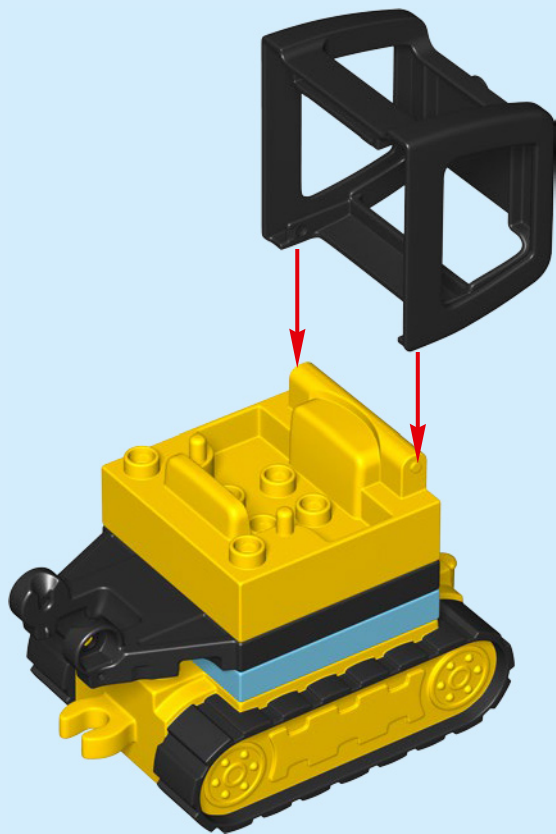

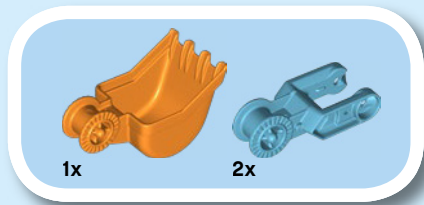

5

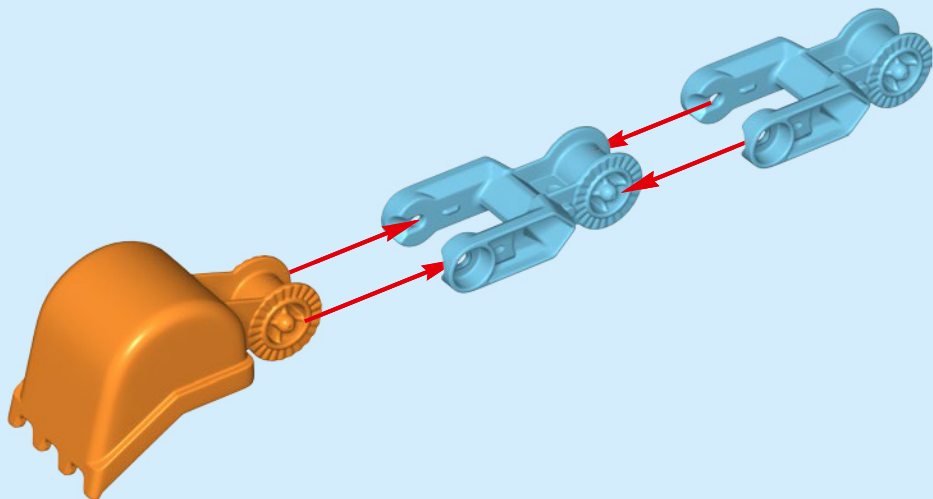

6

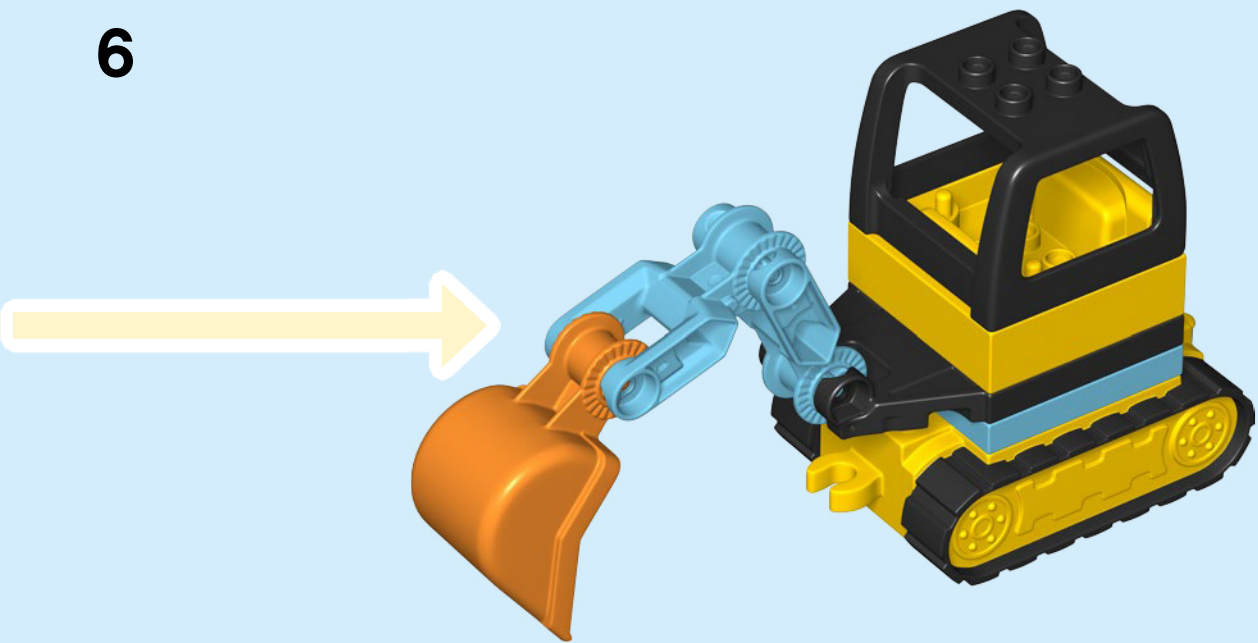



7

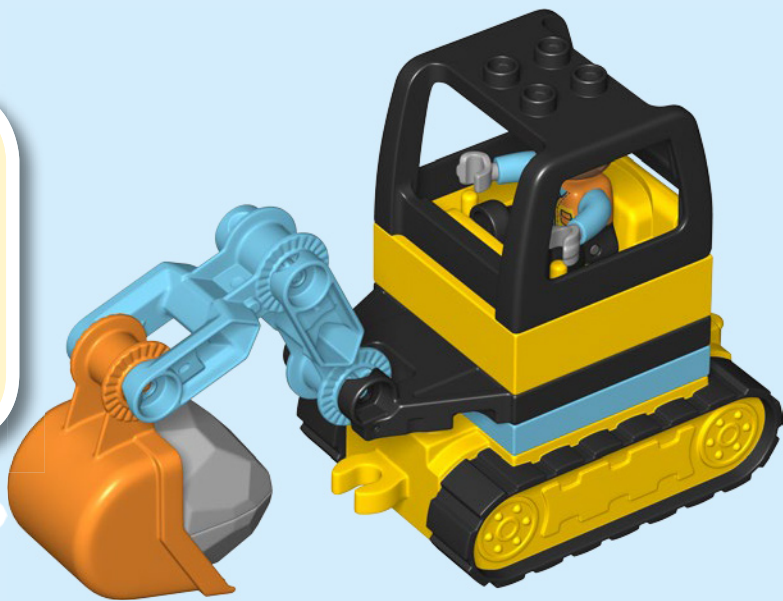
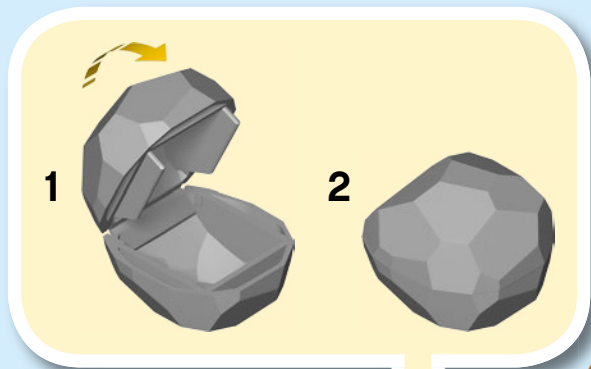

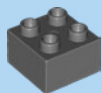

1x

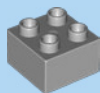

1x

8

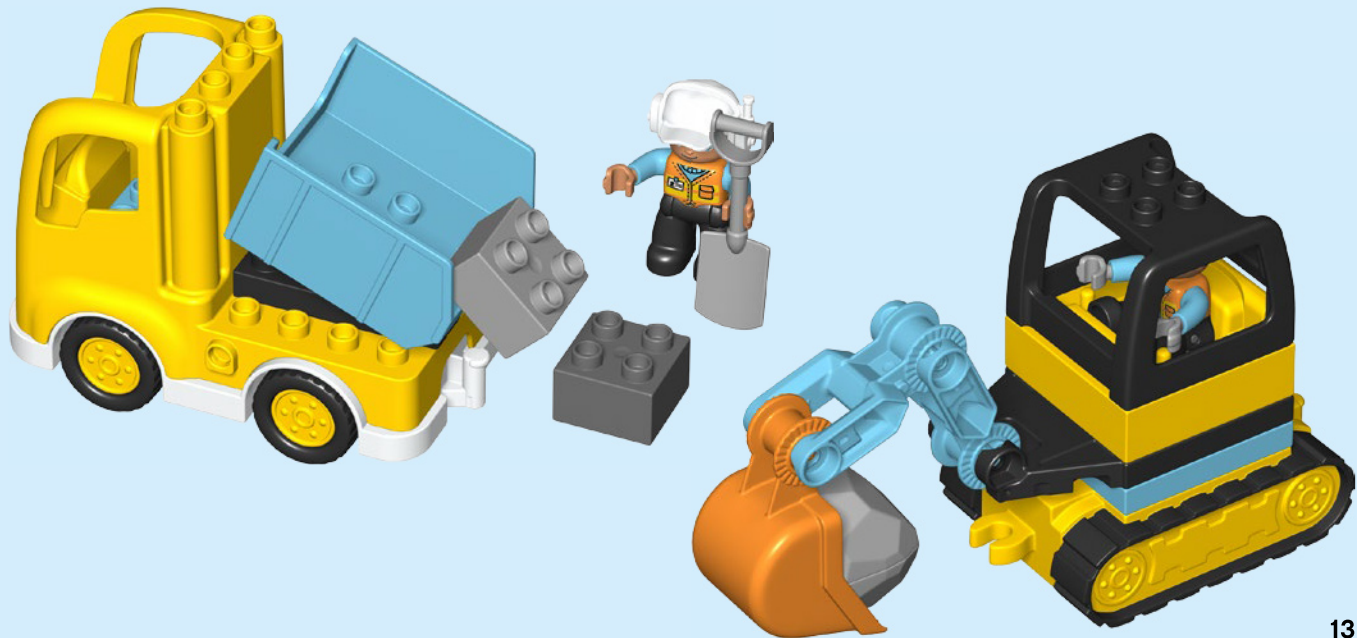



duplo

Age

1 1/2

10915
Age 1 1/2+



Light brick
Leuchtbaustein
Brique lumineuse
Mattoncino luminoso
Ladrillo luminoso
Peca luminosa
Világító elem
Gaismas klucitís
发光积木

LIGHT BRICK

2+

10933
Age 2+



LIGHT & SOUND

LIGHT & SOUND

PUSH & GO

Push & Go
Actionné par poussée
Told és indul
Inercos motors
一推就走

Light & sound
Licht und Ton
Effets sonores et lumineux
Luci e suoni
Luz y sonido
Luz e som
Fény és hang
Gaismas un skapas
声效与光效

10913
Age 1 1/2+

Extra Ideas Included
Mit zusätzlichen Bauidéen
Idées supplémentaires incluses
Idee aggiuntive incluse
Incluye ideas extra
Inclui Ideias Extra
Extra ötletek a csomagban
leklautas papildu idejas
内含更多创意

EXTRA
IDEAS
INCLUDED





A WORLD OF LEGO® DUPLO®

EINE LEGO® DUPLO® WELT / LE MONDE DE LEGO®
DUPLO® / UN MONDO DI LEGO® DUPLO® / UN MUNDO
DE LEGO® DUPLO® / UM MUNDO DE LEGO® DUPLO® /
A LEGO® DUPLO® VILÁGA / LEGO® DUPLO® PASAULE
丰富多彩的乐高®得宝®世界



The availability of apps is subject to the local strategies of the LEGO Group.

Die Verfügbarkeit der Apps unterliegt der Strategie der LEGO Gruppe für das jeweilige Land.

La disponibilité des applications est soumise aux stratégies locales du groupe LEGO.

La disponibilità dell'app è soggetta alle strategie locali del LEGO Group.

La disponibilidad de las apps está sujeta a las estrategias regionales de The LEGO Group.

A disponibilidade das apps está sujeita às estratégias locais do Grupo LEGO.

Az alkalmazások elérhetőségét a LEGO Csoport helyi stratégiája határozza meg.

Lietotņu pieejamība ir atkarīga no LEGO Group vietējās stratēģijas.

相关应用是否在当地发行取决于乐高集团在当地的市场策略



Customer Service
Kundenservice
Service Consommateurs
Servicio Al Consumidor

LEGO.com/service or dial

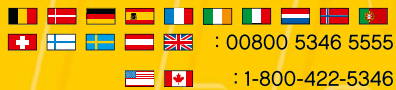
 : 00800 5346 5555
: 1-800-422-5346



Go to www.LEGO.com/productfeedback
and give us your short
win
feedback about this
LEGO® DUPLO® set for a chance to win
a cool LEGO prize

Terms & Conditions apply

LEGO.com/productfeedback

GEWINNE

Erzähle uns auf
www.LEGO.com/productfeedback

etwas über die Erfahrungen, die du
mit diesem LEGO® Set gemacht hast,
und sichere dir die Chance auf einen
coolen LEGO Preis!

Es gelten die Teilnahmebedingungen

GAGNE

Rends-toi sur
www.LEGO.com/productfeedback

et donne-nous quelques commen-
taires sur ce produit LEGO® pour
avoir une chance de gagner un
prix LEGO !

Voir Conditions Générales

GANAN

Visita
www.LEGO.com/productfeedback

y envíanos tu opinión acerca de este
set LEGO®. ¡Participarás en el sorteo
de un premio LEGO!

Términos y Condiciones aplicables

获取奖品

登录
www.LEGO.com/productfeedback

给出关于此乐高®套装的简短反
馈，就有机会获得炫酷乐高奖品

《条款及条件》适用

LEGO, the LEGO logo and DUPLO are trademarks of the LEGO Group. ©2020 The LEGO Group.