

Wariant LEWY
Variant L

Wariant PRAWY
Variant R

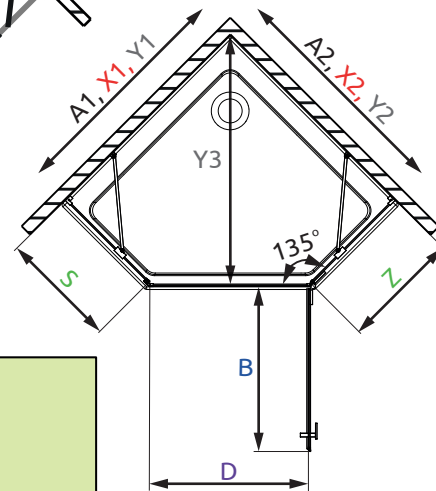
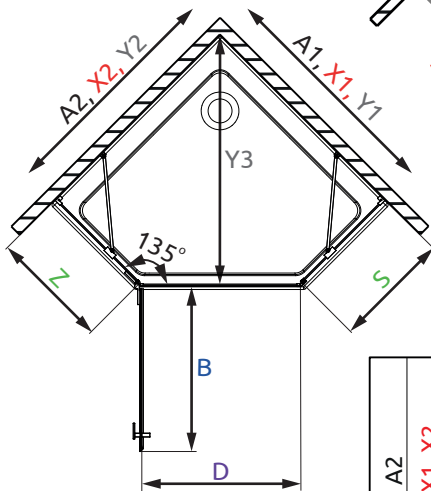

Wariant LEWY / Variant L

Wariant PRAWY / Variant R

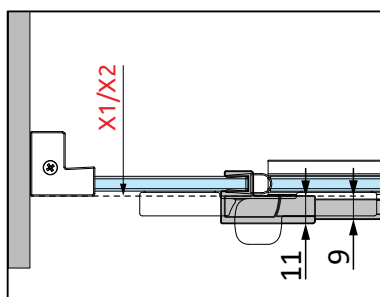
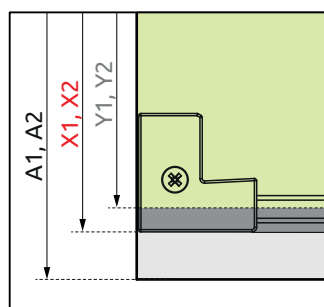

Model	A1	A2	X1	X2	Y1	Y2	Y3	B	Z	S	D	H
PTJ 80Zx80S	800	800	772-787	772-787	767-782	767-782	778-799	620	340-355	335-350	600	2000
PTJ 80Zx90S	800	900	772-787	872-887	767-782	867-882	849-870	620	340-355	435-450	600	2000
PTJ 80Zx100S	800	1000	772-787	972-987	767-782	967-982	919-940	620	340-355	535-550	600	2000
PTJ 90Zx80S	900	800	872-887	772-787	867-882	767-782	849-870	620	440-455	335-350	600	2000
PTJ 90Zx90S	900	900	872-887	872-887	867-882	867-882	919-940	620	440-455	435-450	600	2000
PTJ 90Zx100S	900	1000	872-887	972-987	867-882	967-982	990-1011	620	440-455	535-550	600	2000
PTJ 100Zx80S	1000	800	972-987	772-787	967-982	767-782	919-940	620	540-555	335-350	600	2000
PTJ 100Zx90S	1000	900	972-987	872-887	967-982	867-882	990-1011	620	540-555	435-450	600	2000
PTJ 100Zx100S	1000	1000	972-987	972-987	967-982	967-982	1061-1082	620	540-555	535-550	600	2000

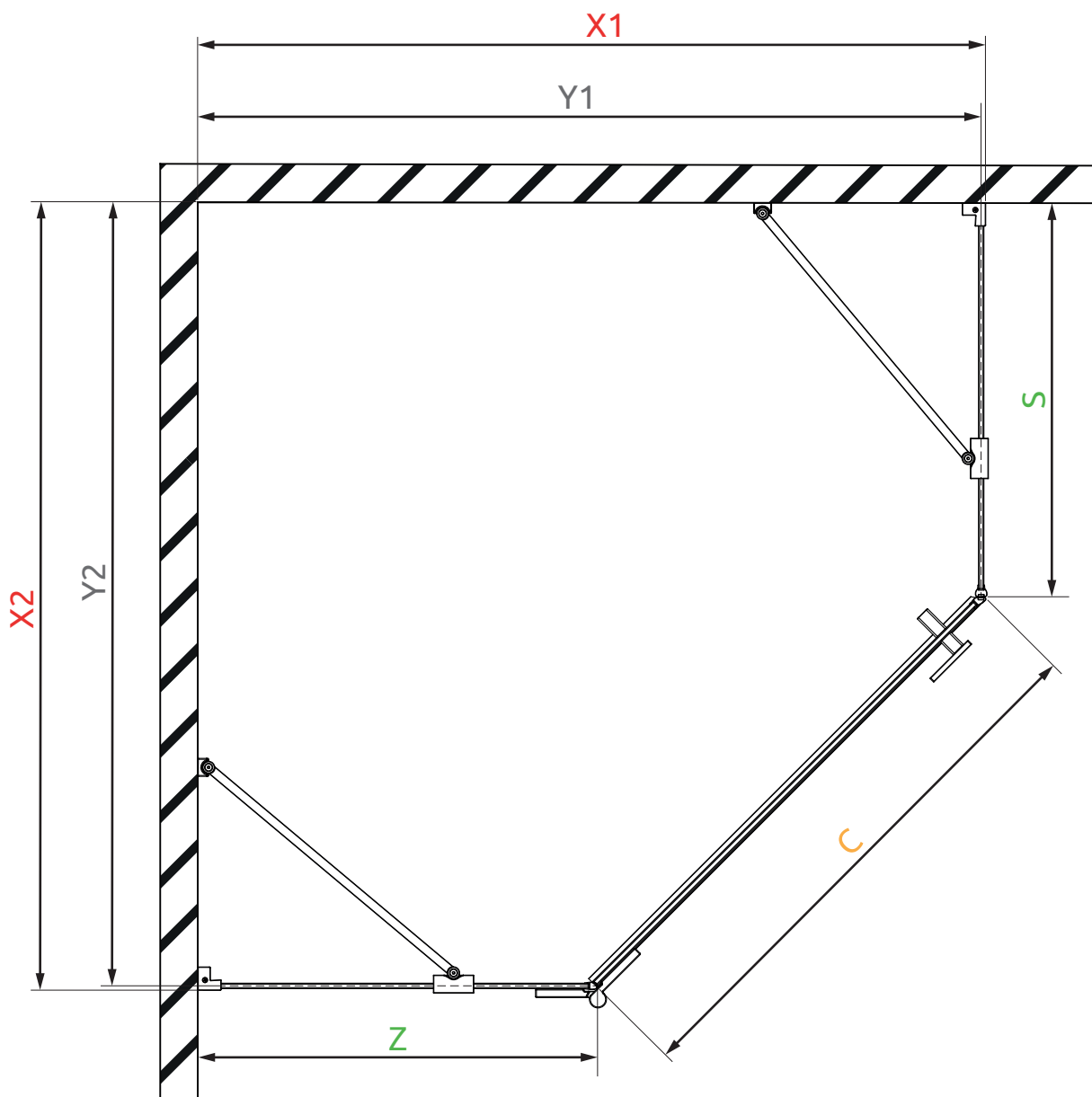

Model	X1*	X2*	Y1*	Y2*	Z*	S*	C*
<i>PTJ 80Zx80S</i>	777	777	772	772	345	340	610
<i>PTJ 80Zx90S</i>	777	877	772	872	345	440	610
<i>PTJ 80Zx100S</i>	777	977	772	972	345	540	610
<i>PTJ 90Zx80S</i>	877	777	872	772	445	340	610
<i>PTJ 90Zx90S</i>	877	877	872	872	445	440	610
<i>PTJ 90Zx100S</i>	877	977	872	972	445	540	610
<i>PTJ 100Zx80S</i>	977	777	972	772	545	340	610
<i>PTJ 100Zx90S</i>	977	877	972	872	545	440	610
<i>PTJ 100Zx100S</i>	977	977	972	972	545	540	610

*Wymiary dotyczą montażu typowej kabiny montowanej zgodnie z instrukcją montażu
 *All dimensions refer to standard shower installation in accordance with the assembly instruction

