

+48 733 689 445

Infolinia czynna: pon. - pt. 8:00 - 18:00

z1@k-4you.eu

z2@k-4you.eu



Signum Color



KASZMIR



GREEN



INDYGO



DUST GREY



Fronty wykonane z solidnej płyty MDF o grubości **19 mm**.



Nóżki regulowane (10 cm) umożliwiają precyzyjne ustawienie szafki nawet na nierównym podłożu.

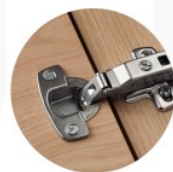

Zawiasy HETTICH Solidne i wytrzymałe zawiasy wyposażone w ciche domykanie.

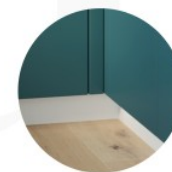

Cokół (10 cm) docięty do szerokości szafki dołączony jest do każdej paczki.



Korpusy wykonane z płyty meblowej o grubości **18 mm**.

DOSTĘPNE KOLORY KORPUSÓW



Korpusy wykonane są z płyty meblowej, laminowanej o grubości **18 mm**.



Wysokiej jakości zawias Hettich z cichym domykaniem* w standardzie.



CZARNY



LAVA



GREY



BIAŁY



DĄB ARTISAN

Wysokość szafek wiszących
360 / 720 / 960 mm

Głębokość* szafek wiszących
325 mm

Wysokość szafek stojących
z nóżkami i cokołem
820 / 154 / 2070 mm

Głębokość* szafek stojących
500 mm

Głębokość* słupków wysokich
565 mm

SZAFKI WISZĄCE / 72 CM



Solidne i wytrzymałe, zawiasy **HETTICH** z cichym zamykaniem.



Zawieszki regulowane, umożliwiają łatwe i precyzyjne zawieszenie szafek.



Zalecamy stosowanie listw montażowych.

(szer./wys./gł.)

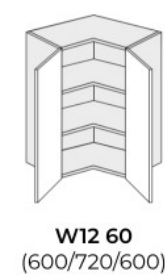
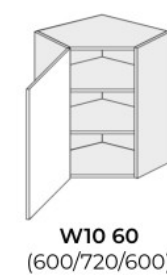
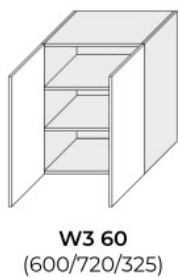
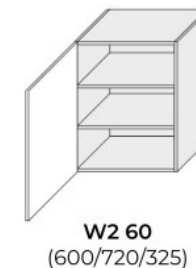
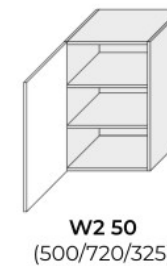
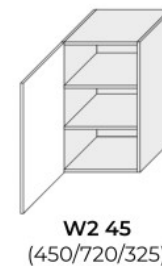
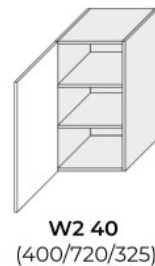
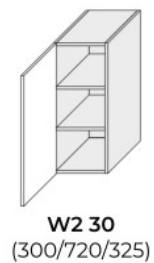
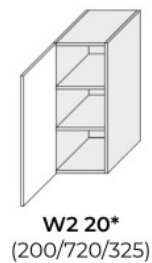
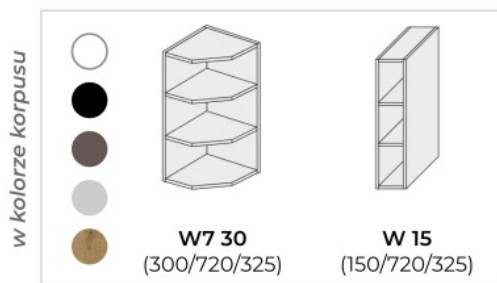

SZAFKI WISZĄCE / 36 CM

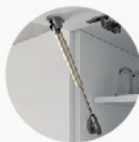

Zastosowanie **teleskopów gazowych** w szafkach otwieranych do góry.



Zawieszki regulowane, umożliwiają łatwe i precyzyjne zawieszenie szafek.

(szer./wys./gł.)



W4B 30
(300/360/325)



W4B 40*
(400/360/325)

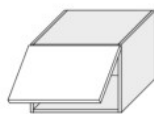

W4B 45*
(450/360/325)

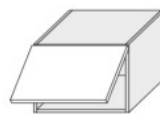

W4B 50
(500/360/325)

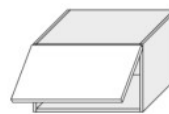

W4B 60
(600/360/325)

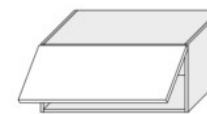

W4B 80
(800/360/325)



W4B 90
(900/360/325)



W4BS 60 WKF*
(600/360/325)



W4BS 80 WKF*
(800/360/325)

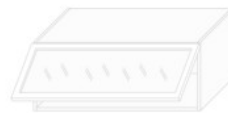

W4BS 90 WKF*
(900/360/325)

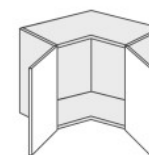

W12/60
(600/360/600)

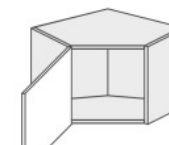

W10/60
(600/360/600)

NADSTAWKI

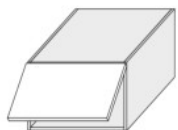

W6B 40
(400/360/565)
nadstawka

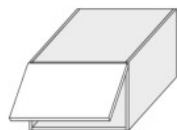

W6B 45*
(450/360/565)
nadstawka



W6B 50*
(500/360/565)
nadstawka

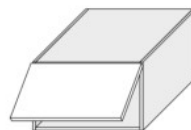

W6B 60
(600/360/565)
nadstawka

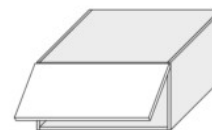

W6B 80
(800/360/565)
nadstawka

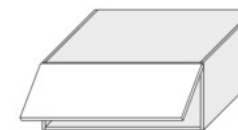

W6B 90
(900/360/565)
nadstawka



W14 90
(900/360/900)
nadstawka narożna

*szafka **niedostępna** w korpusie LAVA

SZAFKI WISZĄCE / 96 CM



Solidne i wytrzymałe, zawiasy **HETTICH** z cichym zamykaniem.



Zawieszki regulowane, umożliwiają łatwe i precyzyjne zawieszenie szafek.



Zalecamy stosowanie listw montażowych.

(szer./wys./gł.)

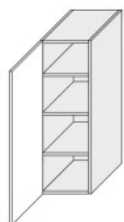

W4 20*
(200/960/325)

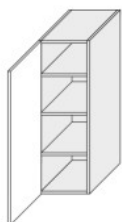

W4 30
(300/960/325)

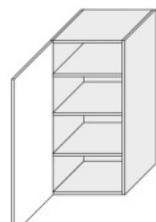

W4 40
(400/960/325)

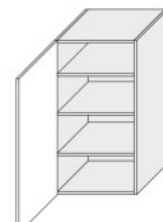

W4 45
(450/960/325)

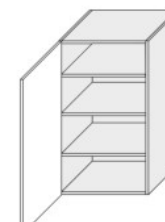

W4 50
(500/960/325)

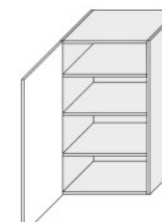

W4 60
(600/960/325)

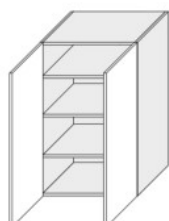

W4 60 2F
(600/960/325)

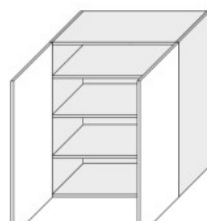

W4 80
(800/960/325)

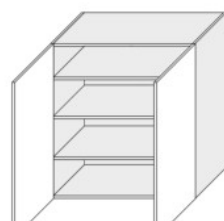

W4 90
(900/960/325)



W4 10/60
(600/960/600)

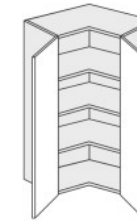

W14 60/96
(600/960/600)



System **AVENTOS** oraz **AVENTOS HK** firmy **BLUM**.
Komfort ruchu oraz swoboda
użytkowania każdego dnia.

(szer./wys./gł.)

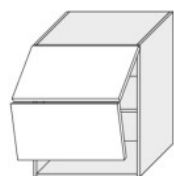

W8B 60 AVENTOS
(600/720/325)

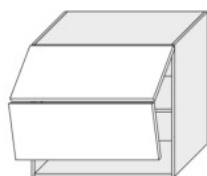

W8B 80 AVENTOS
(800/720/325)

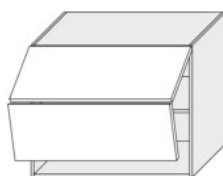

W8B 90 AVENTOS
(900/720/325)

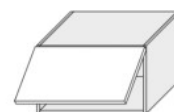

W4B 60 AVENTOS HK
(600/360/325)

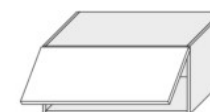

W4B 80 AVENTOS HK
(800/360/325)



W4B 90 AVENTOS HK
(900/360/325)



W8BS 60 AV WKF*
(600/720/325)



W8BS 80 AV WKF*
(800/720/325)



W8BS 90 AV WKF*
(900/720/325)



W6B 40 AV HK
(400/360/565)
nadstawka

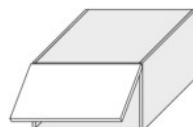

W6B 45 AV HK*
(450/360/565)
nadstawka



W6B 50 AV HK*
(500/360/565)
nadstawka

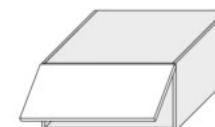

W6B 80 AV HK
(800/360/565)
nadstawka



W6B 90 AV HK
(900/360/565)
nadstawka

SZAFKA PRZYGOTOWANA POD OKAP

SZAFKA POD MIKROFAŁĘ

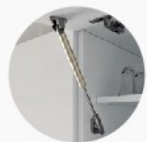

Zastosowanie **teleskopów gazowych** w szafkach otwieranych do góry.

(szer./wys./gł.)



zdjęcie przykładowe

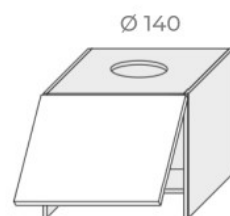

W8 60
(600/500/325)



zdjęcie przykładowe

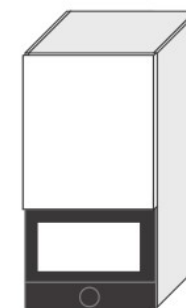

W4MK 60/96
(600/960/325)

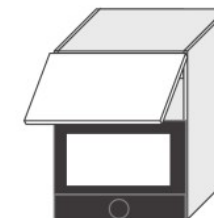

W2MK/60
(600/720/325)



Szafka **PREMIUM** w korpusie **CZARNA PERŁA** z szybą przezroczystą w czarnej ramce aluminiowej.

*brak opcji cichego domykania w standardzie.



zdjęcie przykładowe

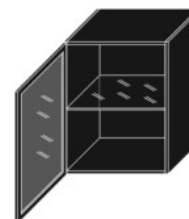

W3S 60 BLACK ALU*
(600/720/325)



SZAFKI STOJĄCE



Solidne i wytrzymałe, zawiasy HETTICH z cichym zamykaniem.



Nóżki regulowane, umożliwiające precyzyjne ustawienie szafki nawet na nierównym podłożu.

(szer./wys./gt.)

w kolorze korpusu

-
-
-
-
-

D6 30
(300/820/500)

D15 O
(150/820/500)

D1D 20*
(200/820/500)

D1D 30
(300/820/500)

D1D 40
(400/820/500)

D1D 45
(450/820/500)

D1D 50
(500/820/500)

D1D 60
(600/820/500)

zabudowa piekarnika

D11K 60
(600/820/500)

pod zlew

D8Z 80
(800/820/500)

D11 60
(600/820/500)

D11 80
(800/820/500)

D11 90
(900/820/500)

D1D 50 + SEGREGO
(500/820/500)

D1D 60 + SEGREGO
(600/820/500)

D1Z 80 + SEGREGO
(800/820/500)



*szafka **niedostępna** w korpusie LAVA

KOSZE CARGO

Przy składaniu zamówienia podaj informację, który typ kosza cargo wybierasz - PURO czy VARIANT.

SERIA PURO

Kolor czarny + dąb, dostępny w wymiarach 15, 30, 40

LUB

SERIA VARIANT MULTI

*Kolor srebrny, dostępny w wymiarach 15, 30, 40, 50, 60

(szer./wys./gł.)

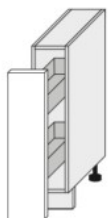

D15 + cargo 15
(150/820/500)

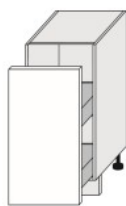

D1D 20 + cargo 20
(200/820/500)

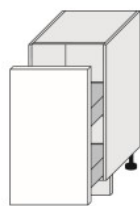

D1D 30 + cargo 30
(300/820/500)

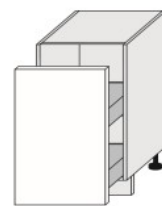

D1D 40 + cargo 40
(400/820/500)

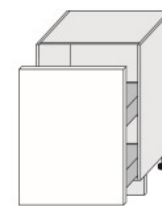

D1D 50 + cargo 50*
(500/820/500)

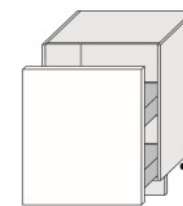

D1D 60 + cargo 60*
(600/820/500)

FRONTY ZMYWARKOWE

Zmywarki do zabudowy wymagają jedynie przedniego panelu. Do ich zabudowy nie jest wymagany dodatkowy korpus.

(szer./wys./gł.)

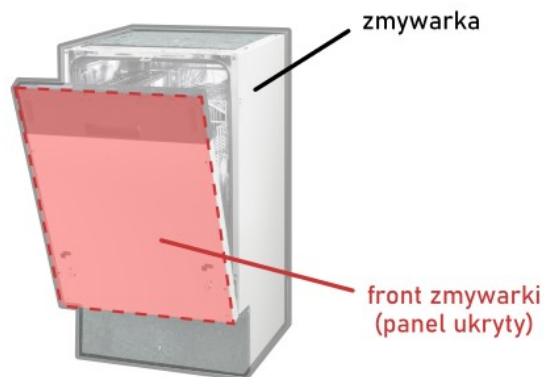

Panel zmywarkowy widoczny



ZM 45/57
(450/570)



ZM 60/57
(600/570)

Panel zmywarkowy niewidoczny



ZM 45
(450/720)



ZM 60
(600/720)



Wysokiej jakości system szuflad **METABOX / BLUM** zapewniają wysoką stabilność, także w przypadkach **maksymalnego obciążenia, które wynosi 30 kg**. Brak cichego domykania w standardzie*.

(szer./wys./gł.)

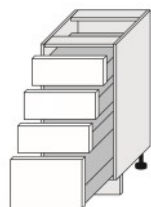

D4M 40 ●
(400/820/500)

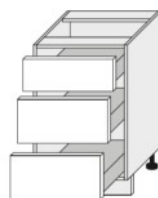

D3M 50 ●
(500/820/500)

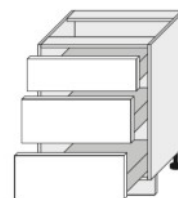

D3M 60 ●
(600/820/500)

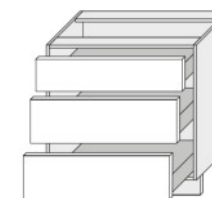

D3M 80 ●
(800/820/500)

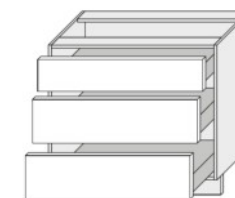

D3M 90 ●
(900/820/500)



Szuflady dostępne w kolorze szarym.

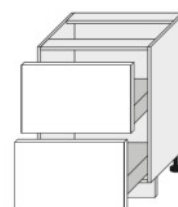

D2M 60 ●
(600/820/500)

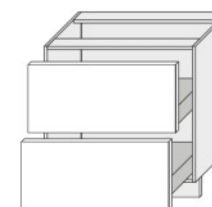

D2M 80 ●
(800/820/500)

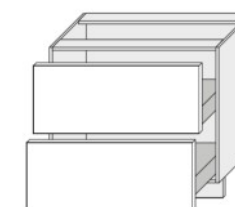

D2M 90 ●
(800/820/500)

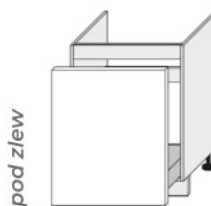

D1ZM 60 ●
(600/820/500)

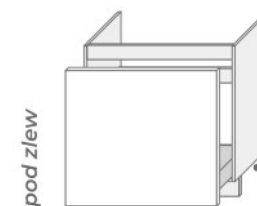

D1ZM 80 ●
(800/820/500)

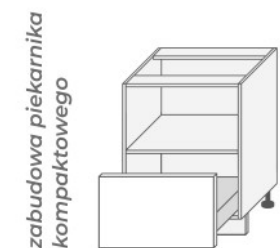

D11K M/60 KOMPAKT ●
(600/820/500)

● - brak cichego domykania* w standardzie. Opcja dodatkowo płatna.

*Do szuflady METABOX z częściowym wysuwem można zastosować sprawdzoną funkcję **BLUMOTION** - jest to dodatkowy hamulec do szuflady, który należy dodatkowo zakupić i zamontować.

Szuflady z serii **COMFORT BOX** to innowacyjne produkty umożliwiające utrzymanie porządku na najwyższym poziomie. **Ładowność do 35kg. Pełny wysuw, prowadnica z miękkim dociąganiem.**



(szer./wys./gł.)

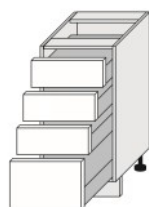

D4R 40
(400/820/500)

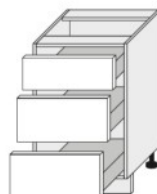

D3R 50
(500/820/500)

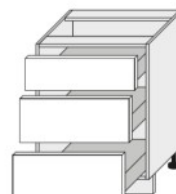

D3R 60
(600/820/500)

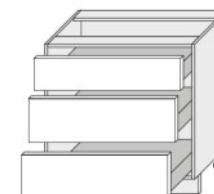

D3R 80
(800/820/500)

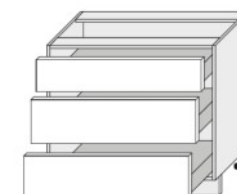

D3R 90
(900/820/500)

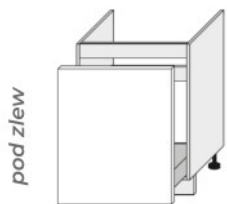

D1ZR 60
(600/820/500)

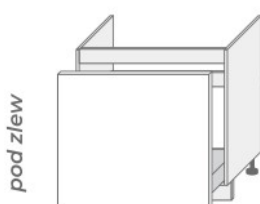

D1ZR 80
(800/820/500)

*zabudowa piekarnika
kompaktowego*

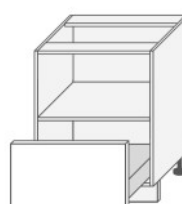

D11K R/60 KOMPAKT
(600/820/500)

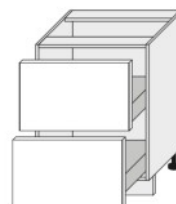

D2R 60
(600/820/500)

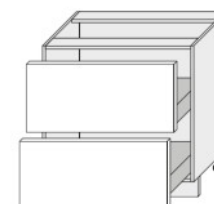

D2R 80
(800/820/500)

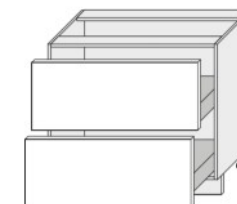

D2R 90
(900/820/500)

PROWADNICE W KOLORZE BIAŁYM.





Wysokiej jakości system szuflad **InnoTech ATIRA** wyposażonych w pełen wysuw oraz **ciche domykanie**. maksymalne obciążenie do **30 kilogramów**.

(szer./wys./gł.)



D4A 40
(400/820/500)

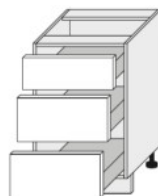

D3A 50
(500/820/500)

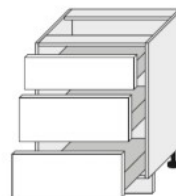

D3A 60
(600/820/500)

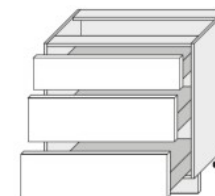

D3A 80
(800/820/500)

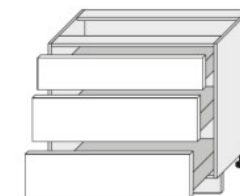

D3A 90
(900/820/500)

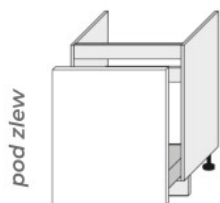

D1ZA 60
(600/820/500)

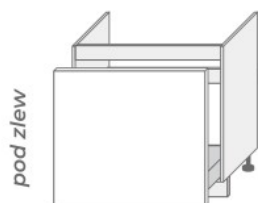

D1ZA 80
(800/820/500)

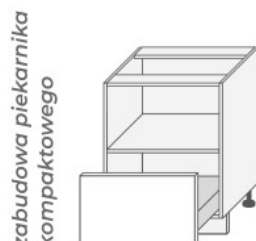

D11K A/60 KOMPAKT
(600/820/500)

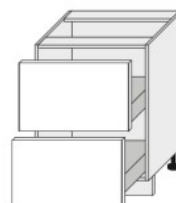

D2A 60
(600/820/500)

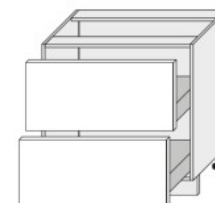

D2A 80
(800/820/500)

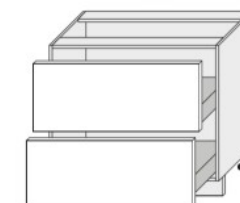

D2A 90
(900/820/500)



PROWDANICE W KOLORZE ANTRACYT.

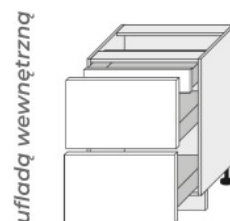

D2A/60/1A
(600/820/500)

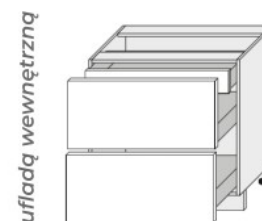

D2A/80/1A
(800/820/500)

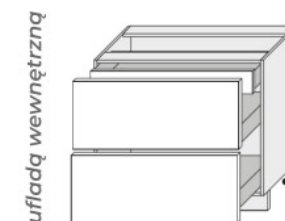

D2A/90/1A
(900/820/500)

SZAFKI STOJĄCE, NAROŻNE

(szer./wys./gł.)

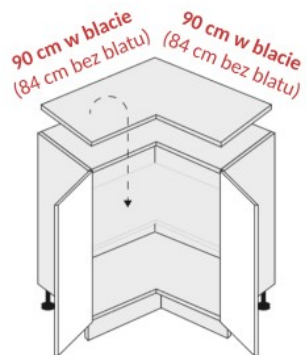

D12 90 bez półki
(840/820/840)

półka dla D12 90



kosz obrotowy

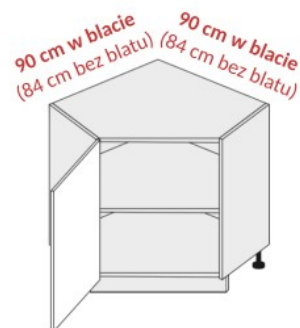

D12R 90
(840/820/840)

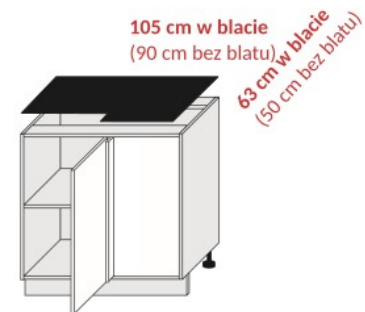

D13U 90 L/P
(900/820/500)

SŁUPKI 154 CM

(szer./wys./gł.)



D5AM 60 / 154 ●
(600/1540/565)



D5AR 60 / 154
(600/1540/565)



D5AA 60 / 154
(600/1540/565)

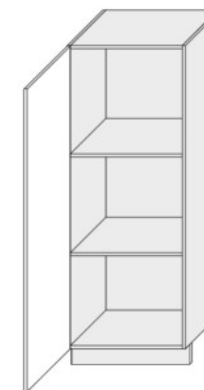

D5D 60 / 154
(600/1540/565)

SŁUPKI 207 CM

(szer./wys./gł.)

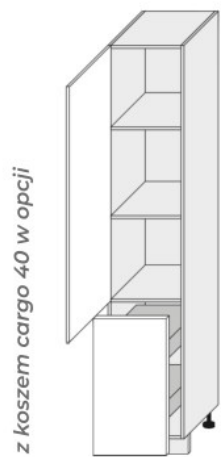

2D14K 40
(400/2070/565)

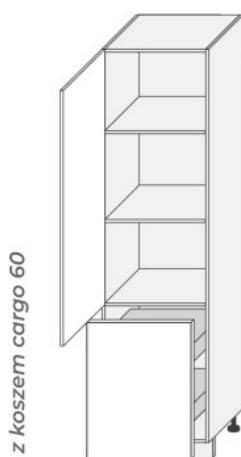

D14DP 60
(600/2070/565)

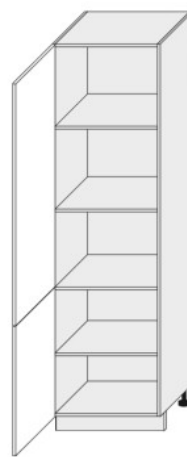

D14 DP 60
(600/2070/565)

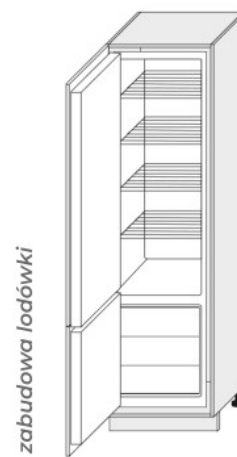

D14 DL 60
(600/2070/565)

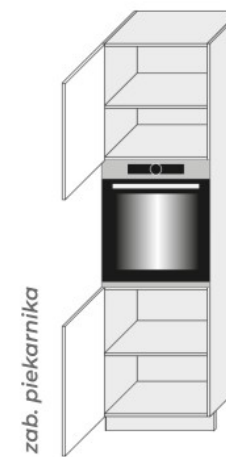

D14 RU 2D 60
(600/2070/565)

blum

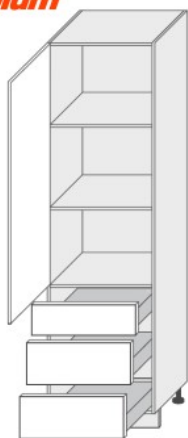

D/14/DP/3M ●
(600/2070/565)

REJS

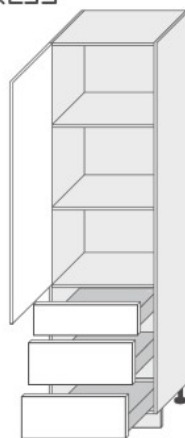

D/14/DP/3R
(600/2070/565)

Hettich

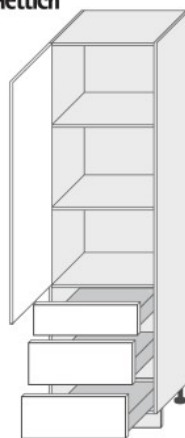

D/14/DP/3A
(600/2070/565)





D14 RU 2M KOMPAKT ●
(600/2070/565)

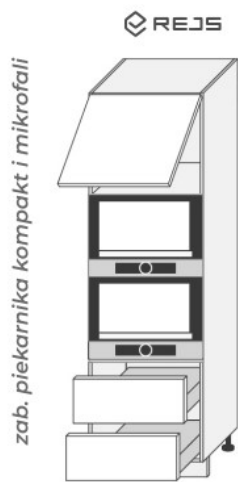

D14 RU 2R KOMPAKT
(600/2070/565)

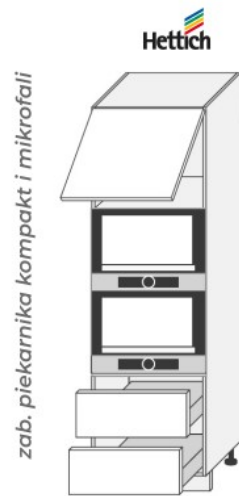

D14 RU 2A KOMPAKT
(600/2070/565)

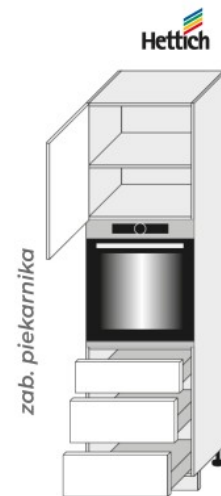

D14 RU 3A 60
(600/2070/565)

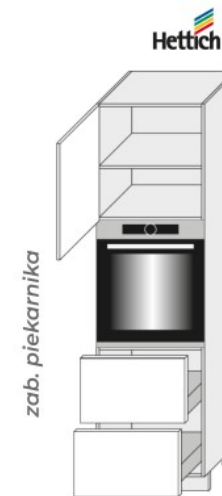

D14 RU 2A 60 356
(600/2070/565)



D14 RU 2A 60 284
(600/2070/565)

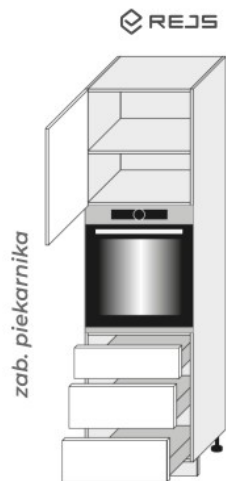

D14 RU 3R 60
(600/2070/565)



D14 RU 2R 60 356
(600/2070/565)

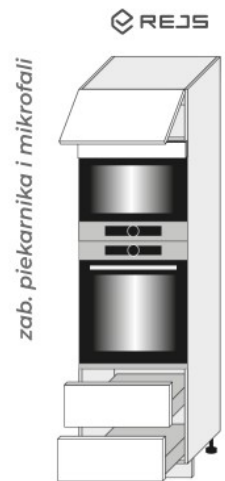

D14 RU 2R 60 284
(600/2070/565)

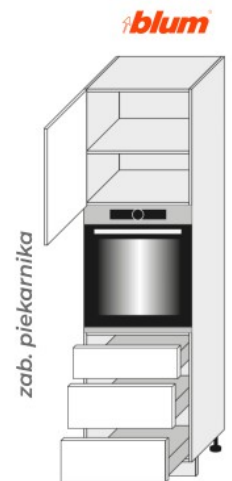

D14 RU 3M 60 ●
(600/2070/565)

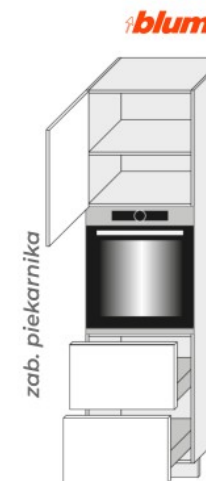

D14 RU 2M 60 356 ●
(600/2070/565)



D14 RU 2M 60 284 ●
(600/2070/565)

● - brak cichego domykania szuflad w standardzie

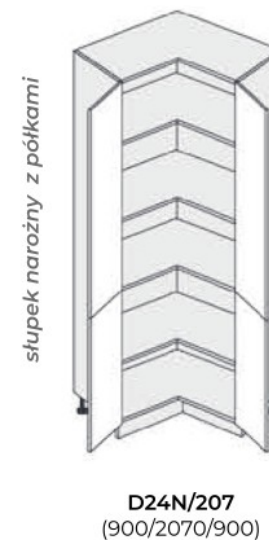
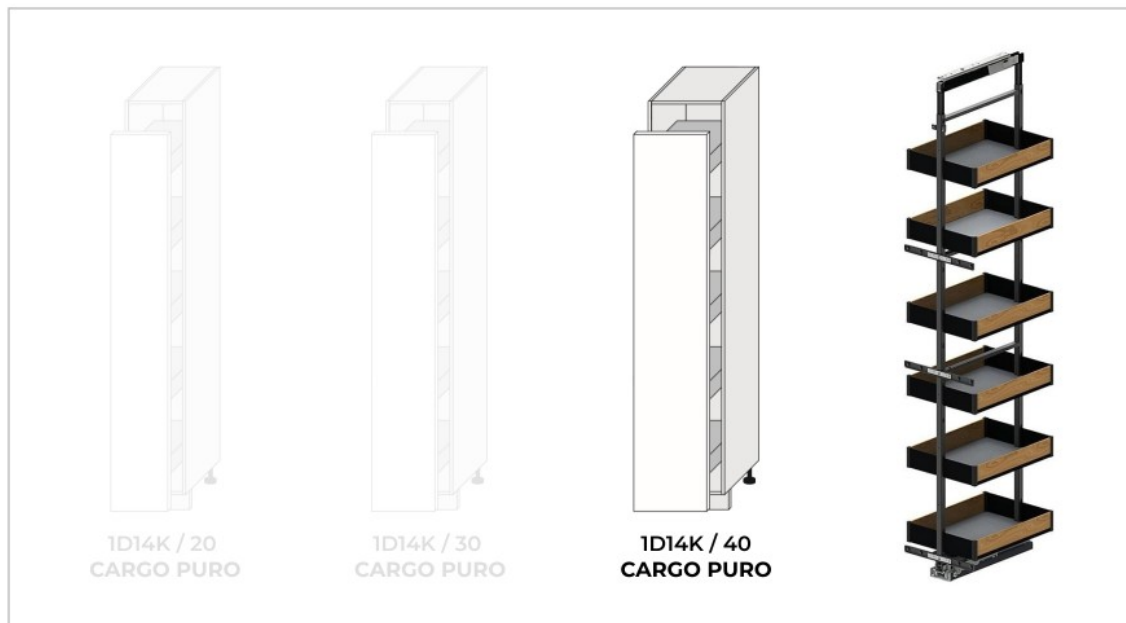

Katalog nie stanowi oferty w rozumieniu prawa i jest publikowany jedynie dla celów informacyjnych. Prowadząc politykę ciągłego rozwoju zastrzegamy sobie prawo do zmian i ulepszeń produktów przedstawionych w katalogu bez uprzedniego powiadomienia. Kolorystyka przedstawiona w katalogu może się różnić od rzeczywistej. Zastrzegamy sobie prawo do błędów w druku.

WYMIARY AGD DO NASZYCH SZAFEK

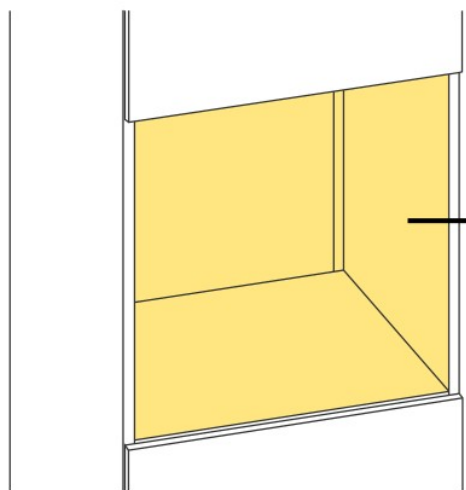

PIEKARNIK
max.
564/590/565
(szer./wys./gł.)

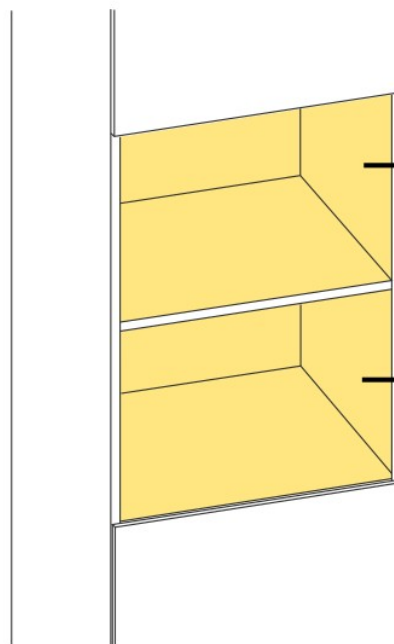

SŁUPEK KOMPAKT
max.
564/450/565
(szer./wys./gł.)

max.
564/450/565
(szer./wys./gł.)

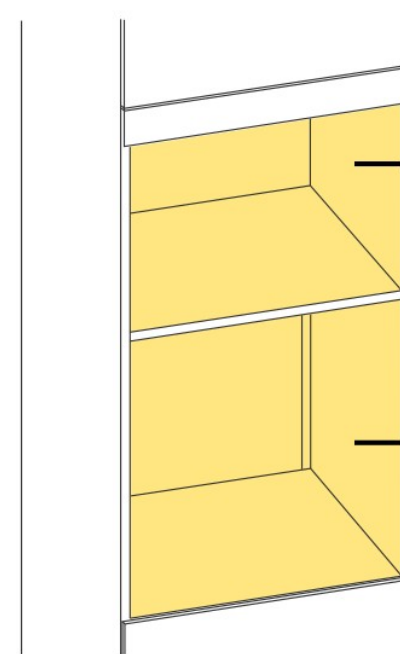

MIKROFALA
max.
564/458/565
(szer./wys./gł.)

PIEKARNIK
max.
564/590/565
(szer./wys./gł.)

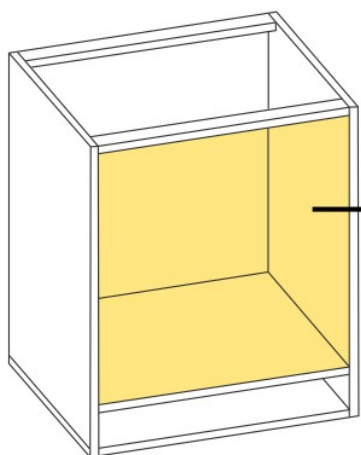

D11K 60
max.
564/600/500
(szer./wys./gł.)

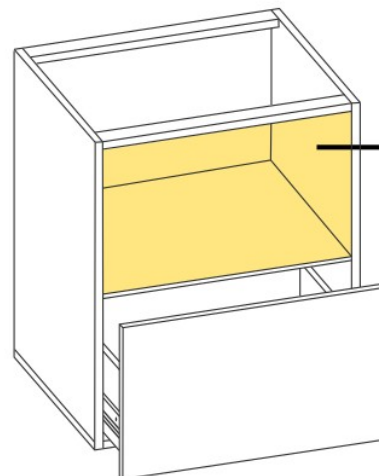

D11K KOMPAKT
max.
564/450/500
(szer./wys./gł.)

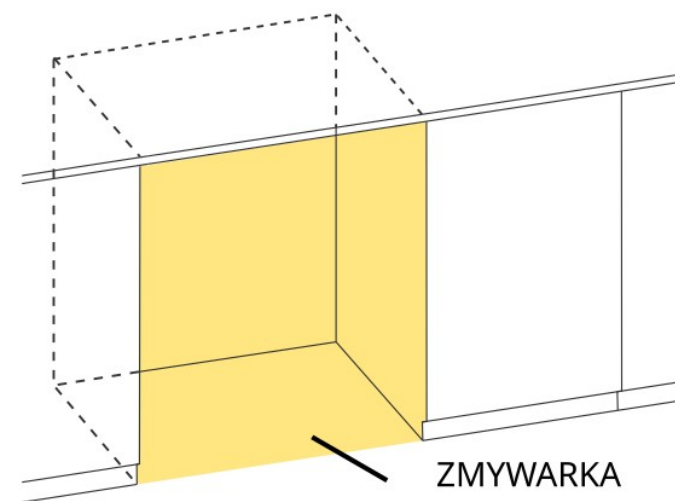

ZMYWARKA
max. **450/820/550**
max. **600/820/550**
(szer./wys./gł.)

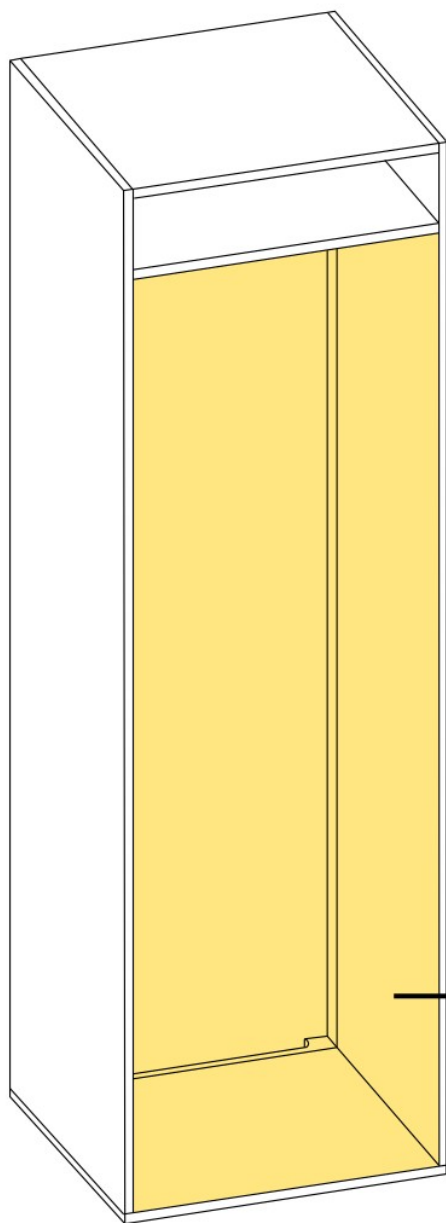

LODÓWKA
max.
1780/564/565
(szer./wys./gł.)

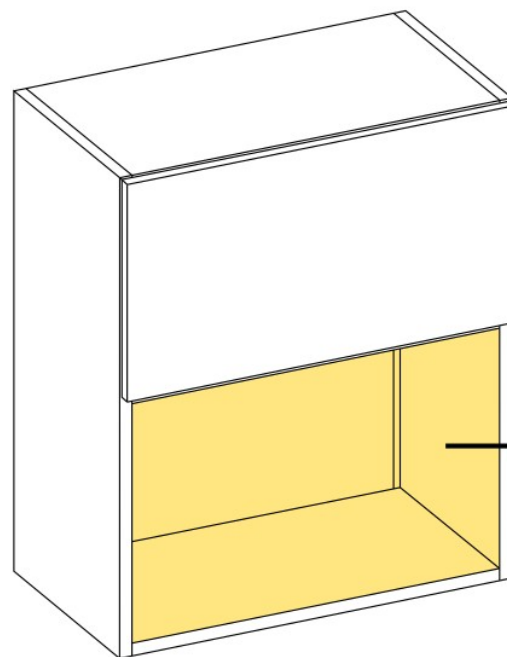

MIKROFALA
max.
564/360/305-325*
(szer./wys./gł.)

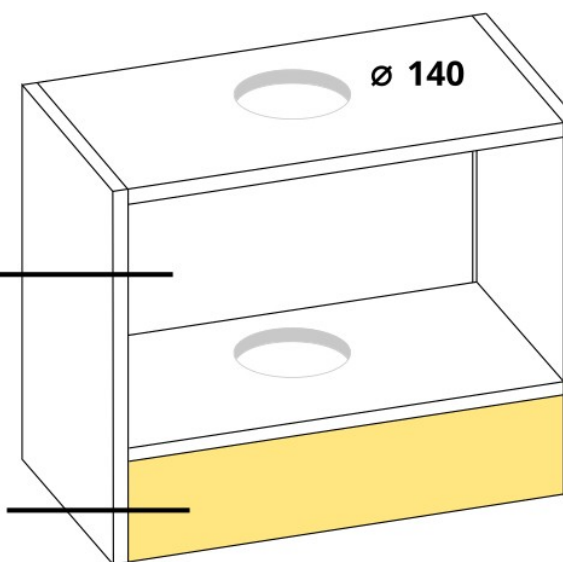

OKAP
max.
564/329/305
(szer./wys./gł.)

max.
564/135/305
(szer./wys./gł.)

Ø 140