

BETHROOM CABINET

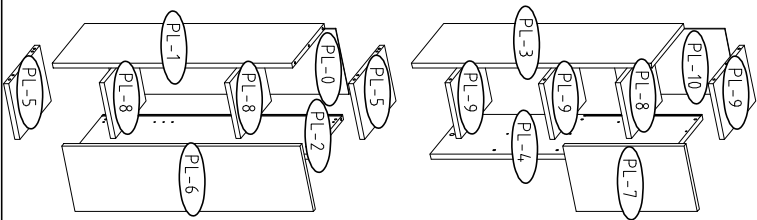

	2		24		14		18
A		B		C		D	
	18		4		4		4
D1		E1		E2		G	
	10		12		4		8
M		P		S		W3	

	20		14		14
B		C		D	

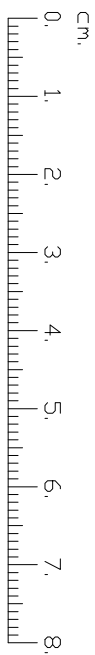
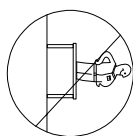
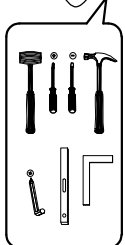
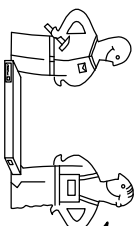
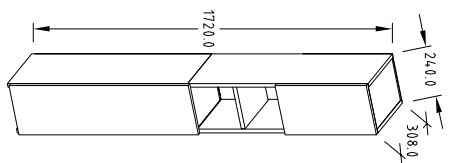
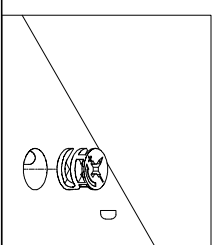
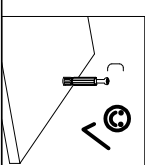
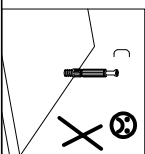
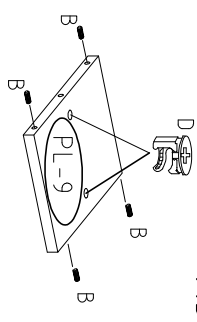
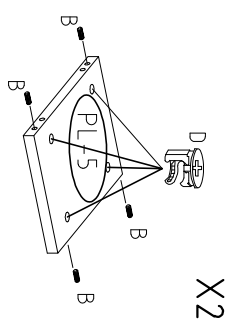
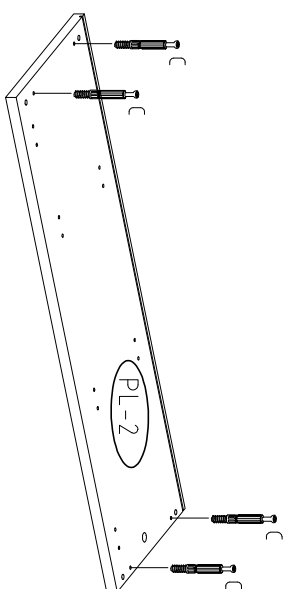
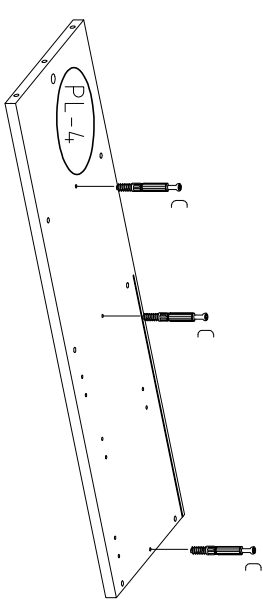
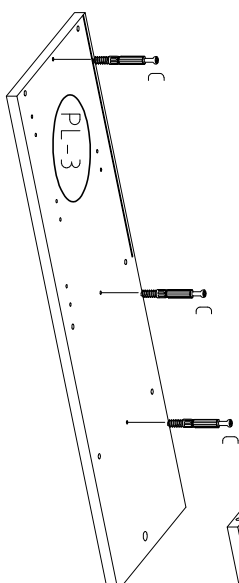
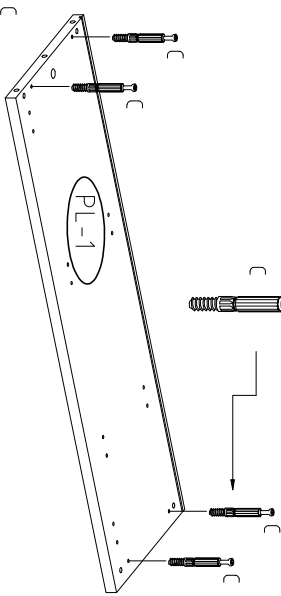
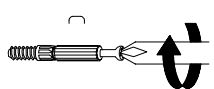

8.0x3.5	
1	A
2	B
2	D

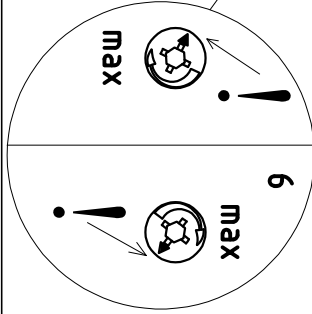
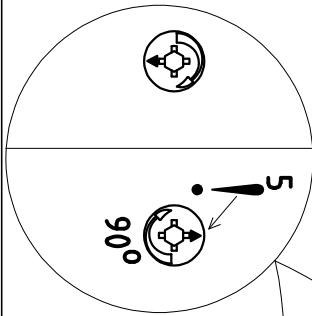
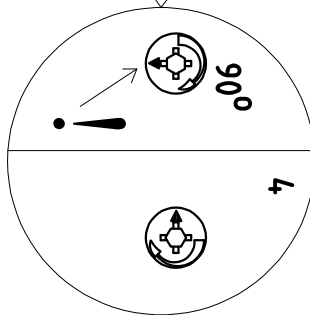
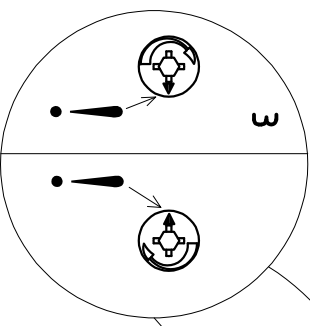
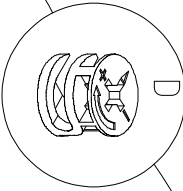
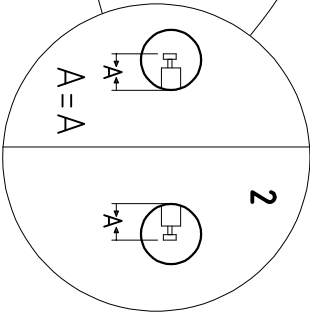
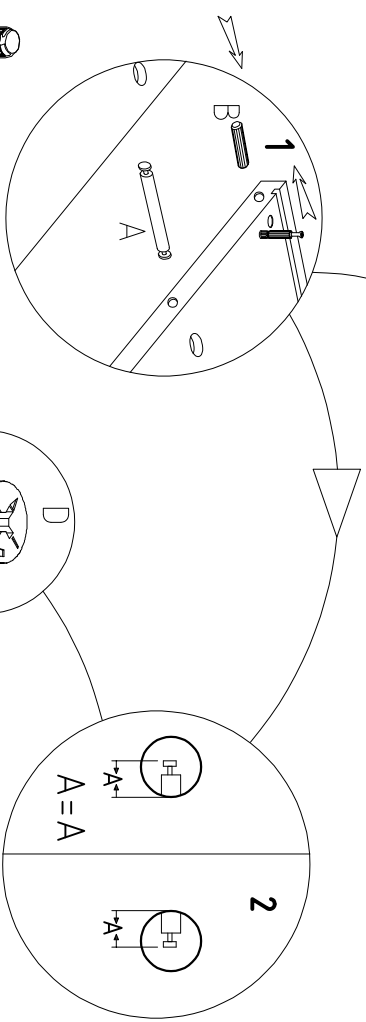
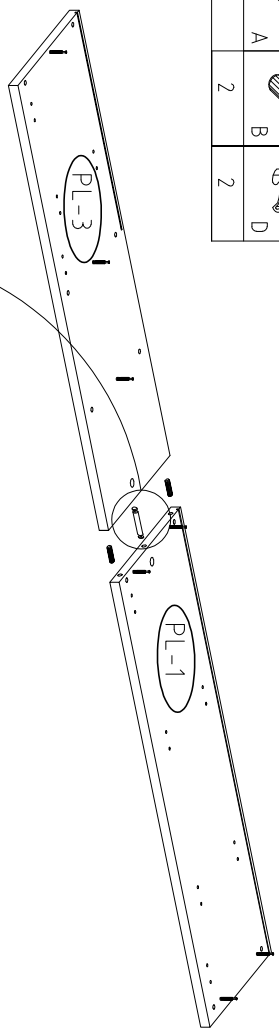

8.0x3.5	
1	A
2	B
2	D

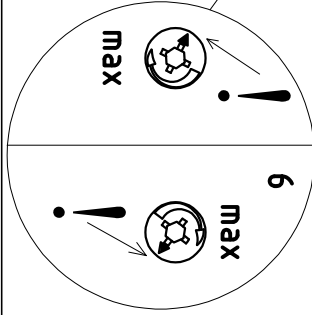
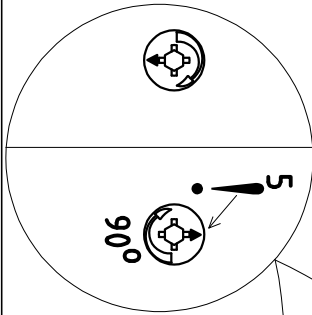
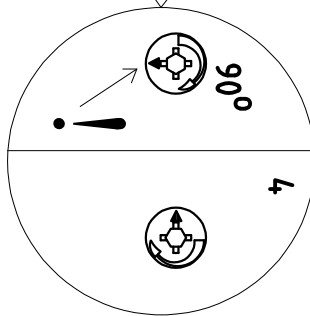
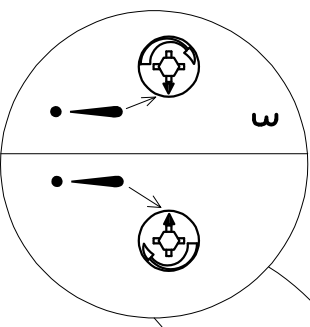
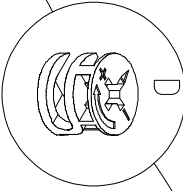
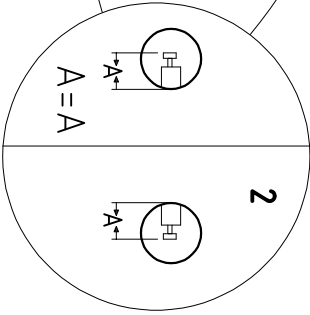
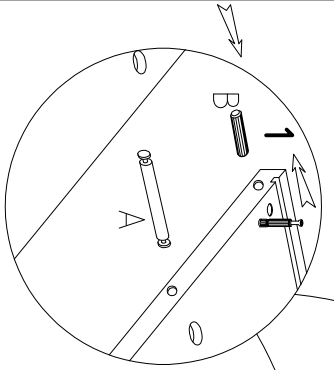
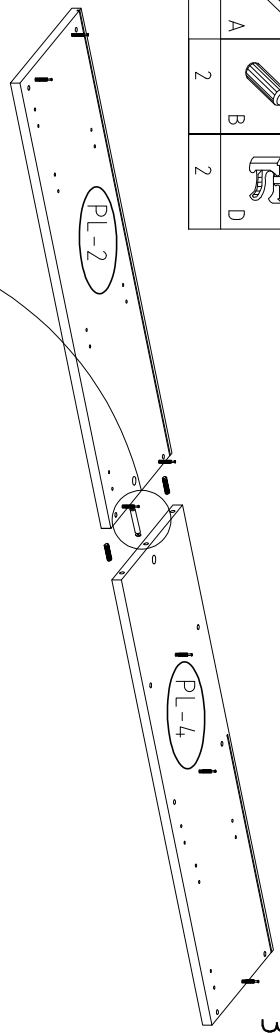

2

3

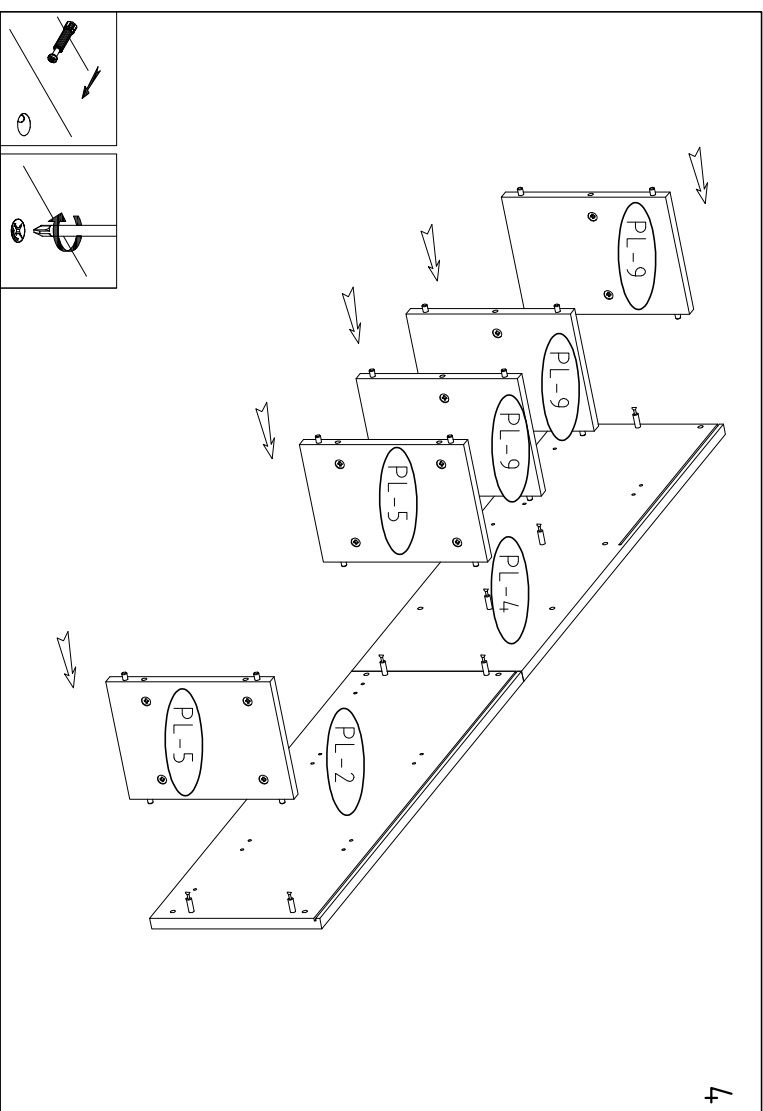

4

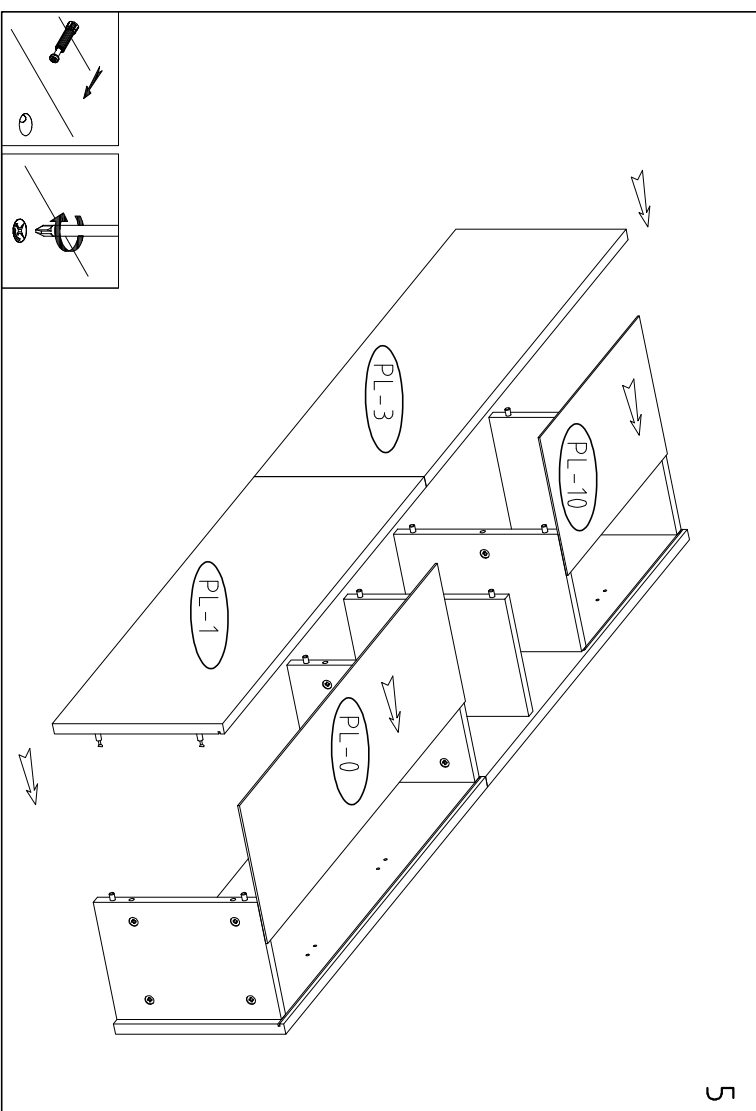

5

10	
M	
4	
G	

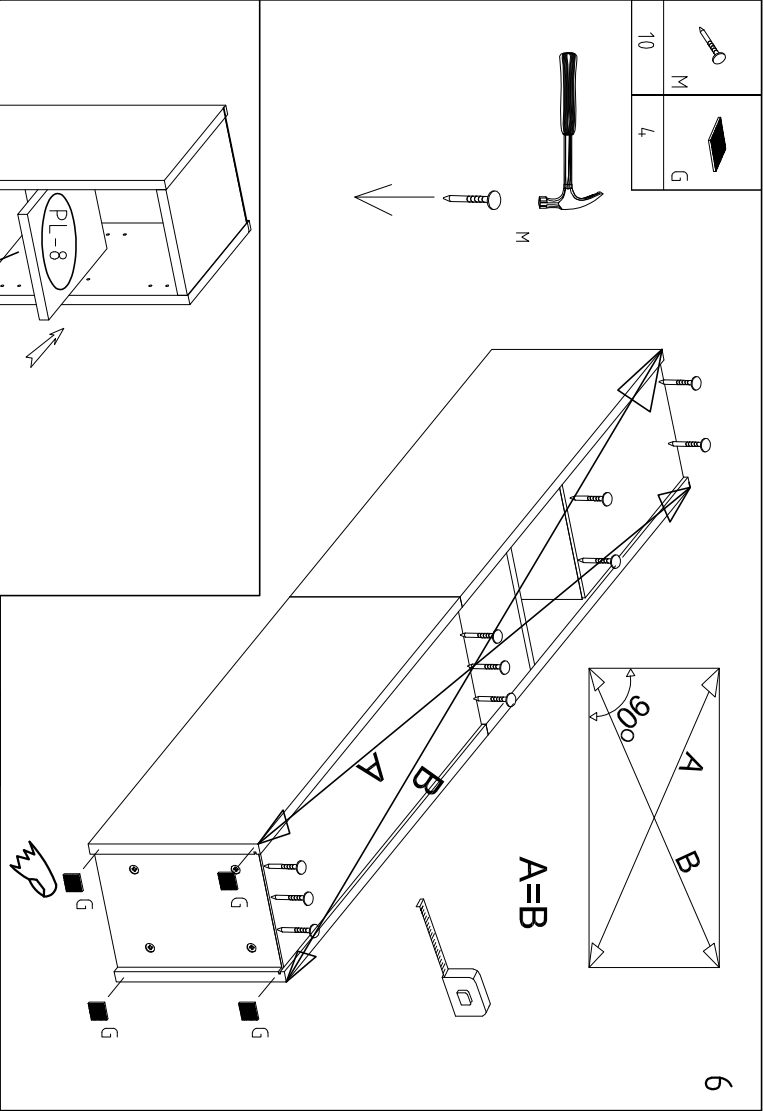
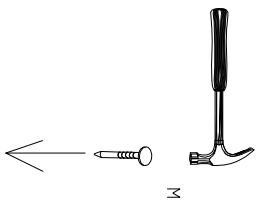

6

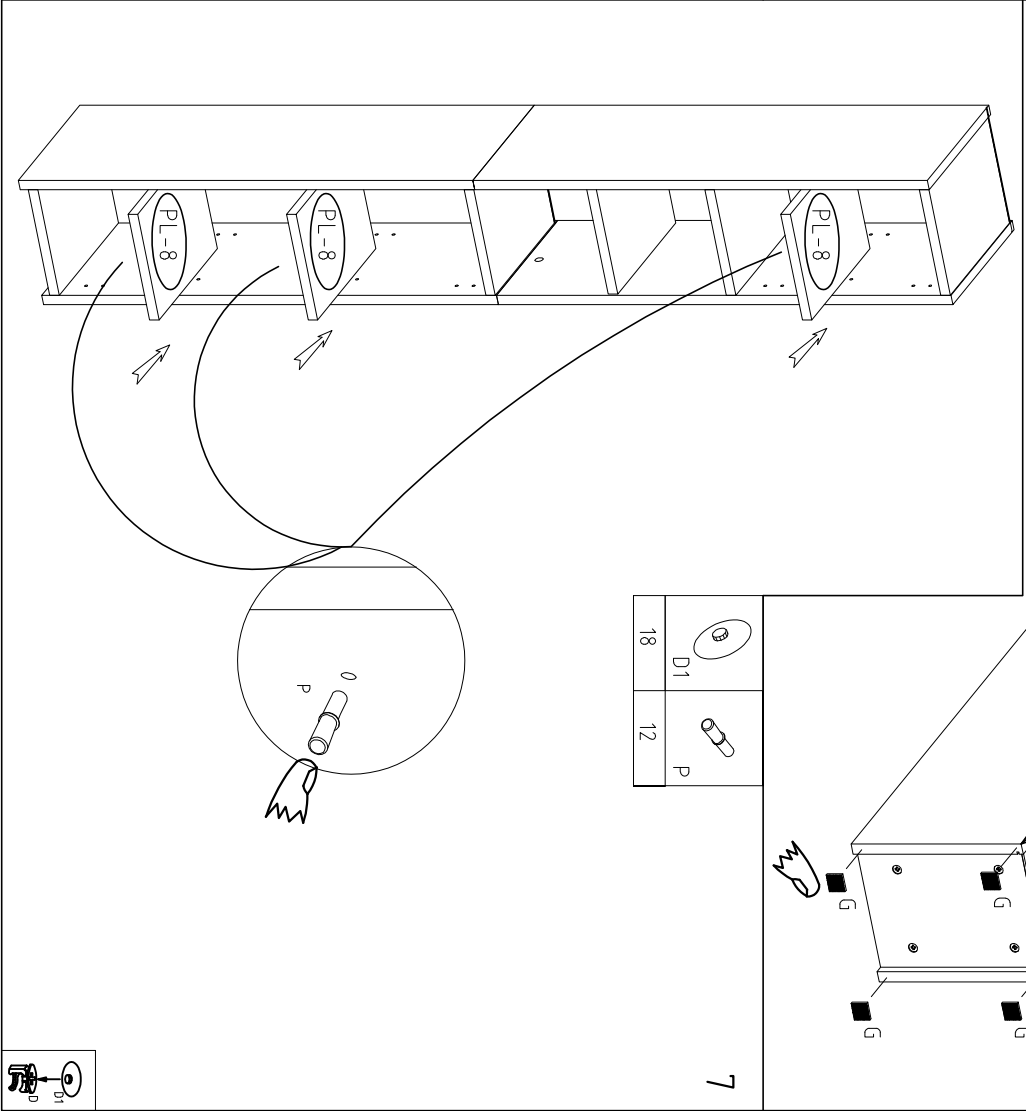

7



W3	S	E1	E2
8	4	4	4

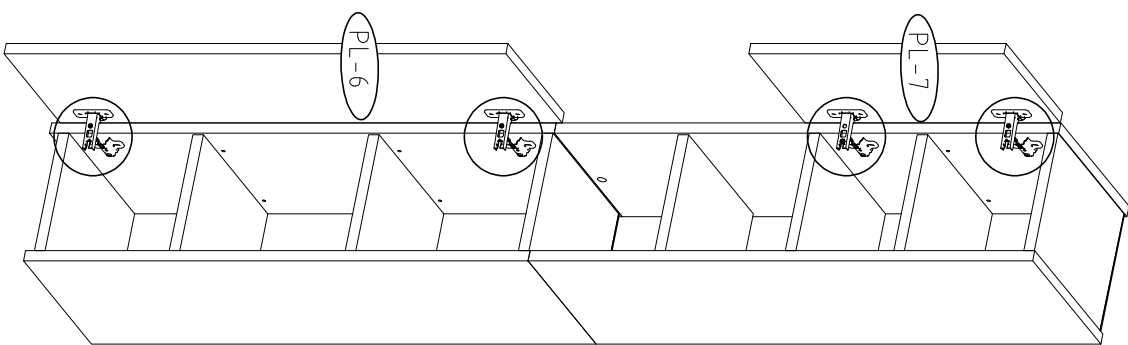
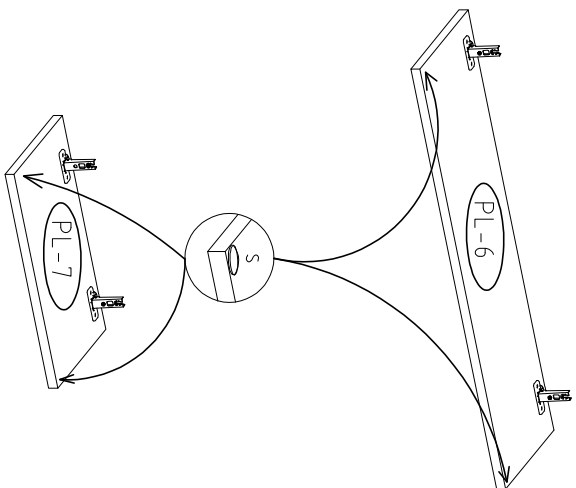
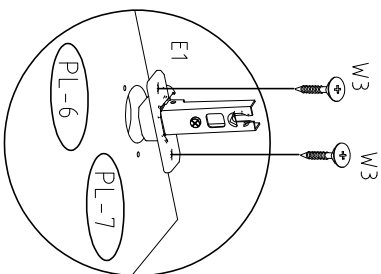
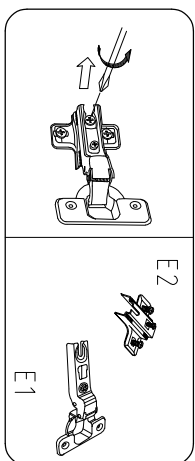

L

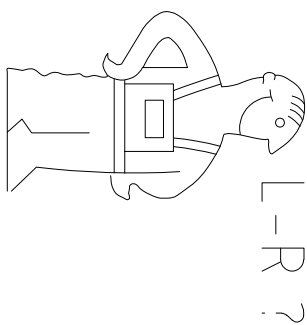
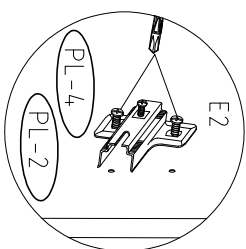
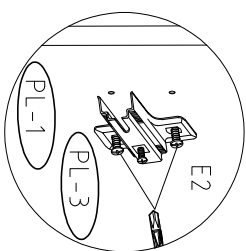

R

