

**Pin Definition:**

- |           |          |
|-----------|----------|
| 1. Source | 8. Drain |
| 2. Source | 7. Drain |
| 3. Source | 6. Drain |
| 4. Gate   | 5. Drain |

**Key Parameter Performance**

Parameter	Value	Unit
$V_{DS}$	20	V
$R_{DS(on)}$ (max)	30	m
$Q_g$	11.2	nC

**Features**

- Advance Trench Process Technology
- High Density Cell Design for Ultra Low On-resistance

**Application**

- Specially Designed for Li-on Battery Packs
- Battery Switch Application

**Ordering Information**

Part No.	Package	Packing
TSM4424CS RL	SOP-8	2.5Kpcs / 13+Reel
TSM4424CS RLG	SOP-8	2.5Kpcs / 13+Reel
TSM4424CS RVG	SOP-8	3Kpcs / 13+Reel

**Note:** %G+denotes for Halogen- and Antimony-free as those which contain <900ppm bromine, <900ppm chlorine (<1500ppm total Br + Cl) and <1000ppm antimony compounds

**Absolute Maximum Ratings** ( $T_C = 25^{\circ}C$ , unless otherwise noted)

Parameter	Symbol	Limit	Unit
Drain-Source Voltage	$V_{DS}$	20	V
Gate-Source Voltage	$V_{GS}$	$\pm 8$	V
Continuous Drain Current	$I_D$	8	A
Pulsed Drain Current <sup>(Note 1)</sup>	$I_{DM}$	30	A
Continuous Source Current (Diode Conduction)	$I_S$	2.2	A
Maximum Power Dissipation	$P_D$	$T_a = 25^{\circ}C$	2.5
		$T_a = 75^{\circ}C$	1.3
Operating Junction Temperature	$T_J$	+150	$^{\circ}C$
Operating Junction and Storage Temperature Range	$T_J, T_{STG}$	-55 to +150	$^{\circ}C$

**Thermal Performance**

Parameter	Symbol	Limit	Unit
Thermal Resistance Junction to Foot	$R_{JF}$	25	$^{\circ}C/W$
Thermal Resistance Junction to Ambient	$R_{JA}$	52.5	$^{\circ}C/W$

**Block Diagram**

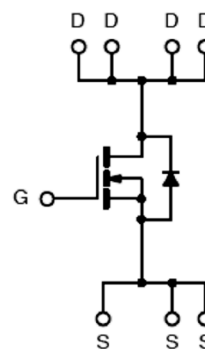

N-Channel MOSFET

### Electrical Specifications

Parameter	Conditions	Symbol	Min	Typ	Max	Unit
<b>Static</b> <sup>(Note 2)</sup>						
Drain-Source Breakdown Voltage	$V_{GS} = 0V, I_D = 250\mu A$	$BV_{DSS}$	20	--	--	V
Gate Threshold Voltage	$V_{DS} = V_{GS}, I_D = 250\mu A$	$V_{GS(TH)}$	--	0.65	1	V
Gate Body Leakage	$V_{GS} = \pm 8V, V_{DS} = 0V$	$I_{GSS}$	--	--	$\pm 100$	nA
Zero Gate Voltage Drain Current	$V_{DS} = 20V, V_{GS} = 0V$	$I_{DSS}$	--	--	1.0	$\mu A$
On-State Drain Current	$V_{DS} = 5V, V_{GS} = 4.5V$	$I_{D(ON)}$	30	--	--	A
Drain-Source On-State Resistance	$V_{GS} = 4.5V, I_D = 4.5A$	$R_{DS(ON)}$	--	23	30	m
	$V_{GS} = 2.5V, I_D = 3.5A$		--	25	35	
	$V_{GS} = 1.8V, I_D = 2.0A$		--	35	45	
Forward Transconductance	$V_{DS} = 10V, I_D = 6A$	$g_{fs}$	--	40	--	S
Diode Forward Voltage	$I_S = 1.7A, V_{GS} = 0V$	$V_{SD}$	--	0.8	1.2	V
<b>Dynamic</b> <sup>(Note 3)</sup>						
Total Gate Charge	$V_{DS} = 10V, I_D = 4.5A,$ $V_{GS} = 4.5V$	$Q_g$	--	11.2	14	nC
Gate-Source Charge		$Q_{gs}$	--	1.4	--	
Gate-Drain Charge		$Q_{gd}$	--	2.2	--	
Input Capacitance	$V_{DS} = 10V, V_{GS} = 0V,$ $f = 1.0MHz$	$C_{iss}$	--	500	--	pF
Output Capacitance		$C_{oss}$	--	300	--	
Reverse Transfer Capacitance		$C_{rss}$	--	140	--	
<b>Switching</b> <sup>(Note 4)</sup>						
Turn-On Delay Time	$V_{DD} = 10V, R_L = 10 \Omega,$ $I_D = 1A, V_{GEN} = 4.5V,$ $R_G = 6 \Omega$	$t_{d(on)}$	--	15	25	ns
Turn-On Rise Time		$t_r$	--	30	60	
Turn-Off Delay Time		$t_{d(off)}$	--	35	70	
Turn-Off Fall Time		$t_f$	--	15	45	

#### Notes:

1. Pulse width limited by the maximum junction temperature
2. Pulse test: PW  $m300\mu s$ , duty cycle  $m2\%$
3. For DESIGN AID ONLY, not subject to production testing.
4. Switching time is essentially independent of operating temperature.

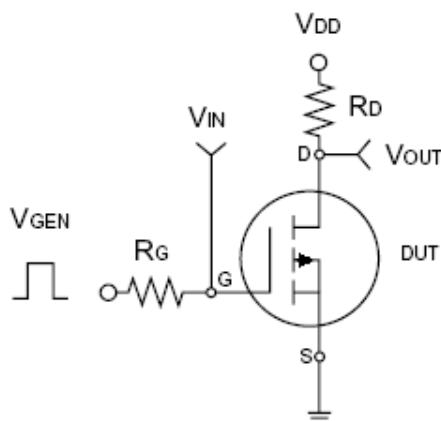

Switching Test Circuit

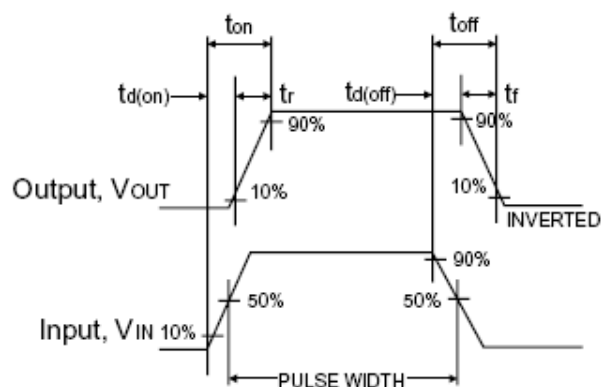

Switchin Waveforms

**Electrical Characteristics Curve**

**Output Characteristics**

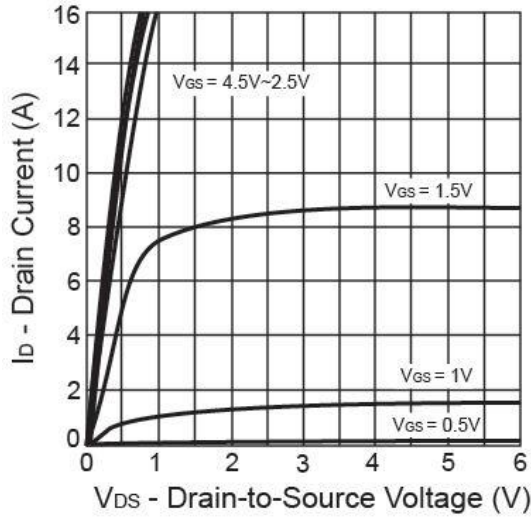

**Transfer Characteristics**

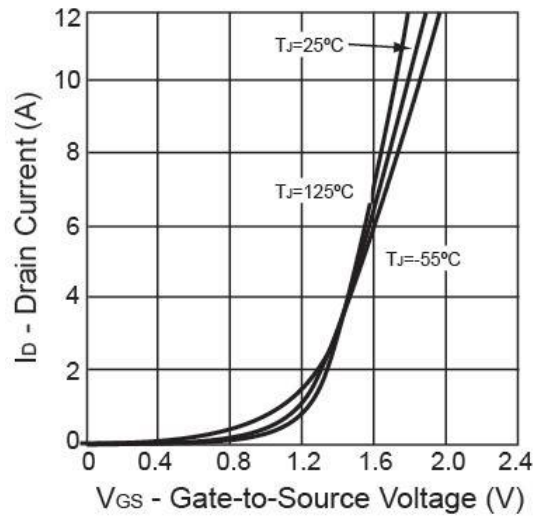

**On-Resistance vs. Drain Current**

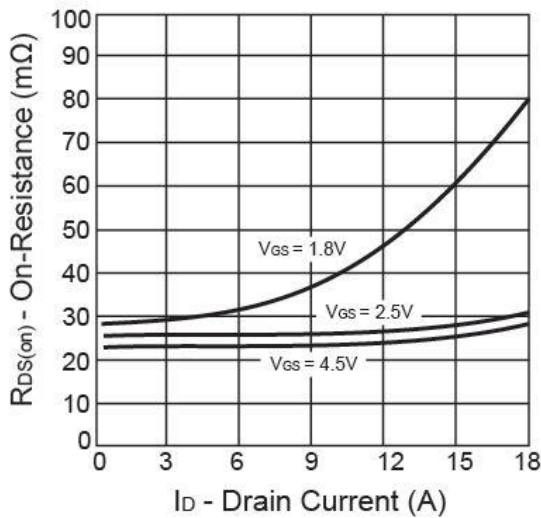

**Gate Charge**

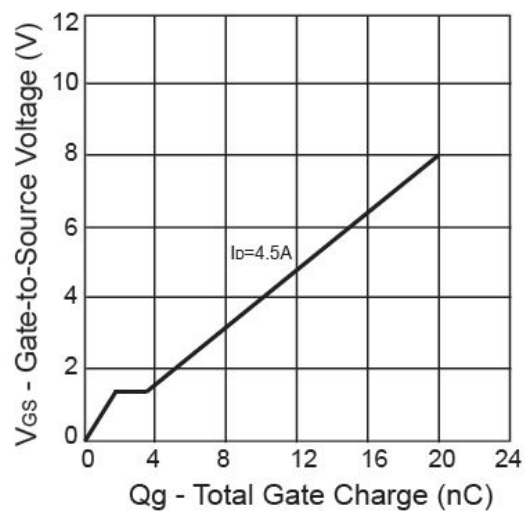

**On-Resistance vs. Junction Temperature**

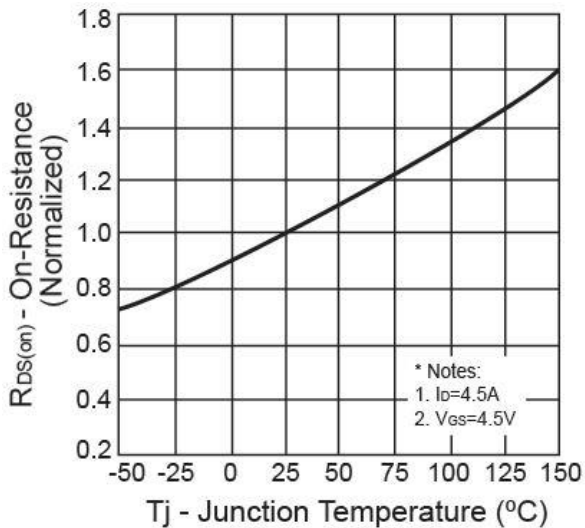

**Source-Drain Diode Forward Voltage**

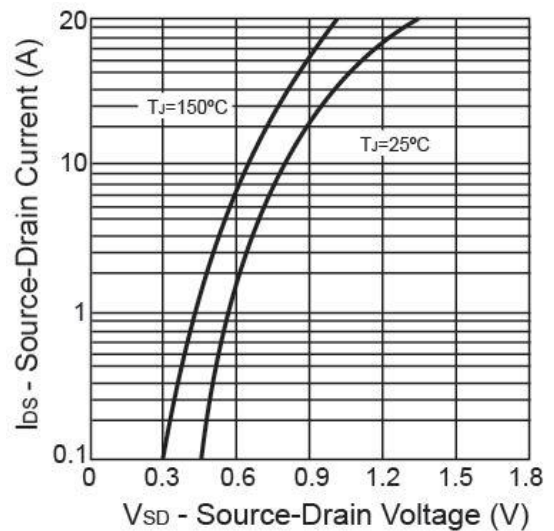

**Electrical Characteristics Curve**

**On-Resistance vs. Gate-Source Voltage**

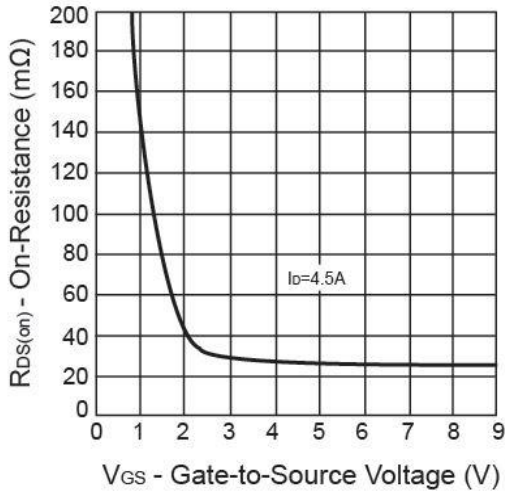

**Threshold Voltage**

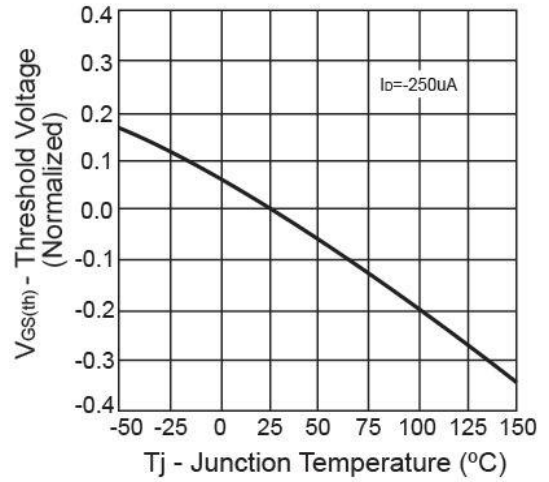

**Safety Operation Area**

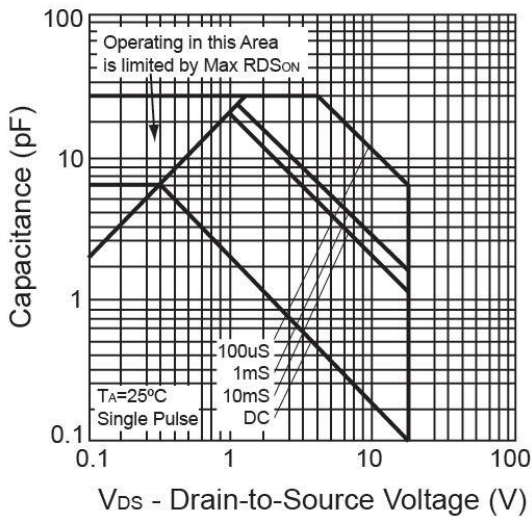

**Normalized Thermal Transient Impedance, Junction-to-Ambient**

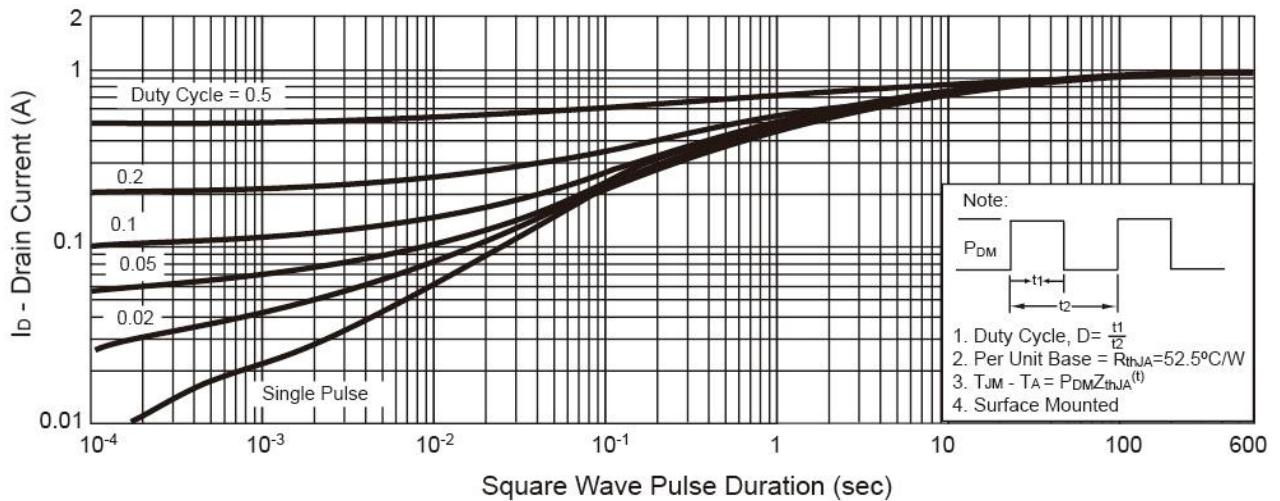

**SOP-8 Mechanical Drawing**

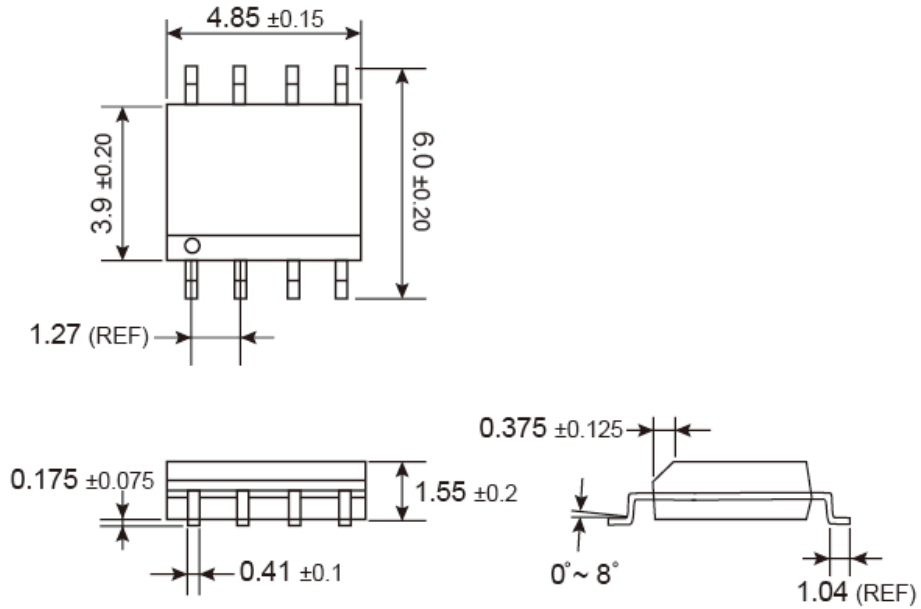

Unit: Millimeters

**Marking Diagram**

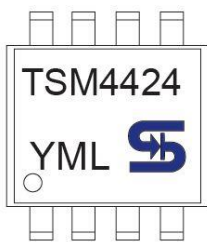

- Y** = Year Code
- M** = Month Code  
(**A**=Jan, **B**=Feb, **C**=Mar, **D**=Apr, **E**=May, **F**=Jun, **G**=Jul, **H**=Aug, **I**=Sep, **J**=Oct, **K**=Nov, **L**=Dec)
- = Month Code for Halogen Free Product  
(**O**=Jan, **P**=Feb, **Q**=Mar, **R**=Apr, **S**=May, **T**=Jun, **U**=Jul, **V**=Aug, **W**=Sep, **X**=Oct, **Y**=Nov, **Z**=Dec)
- L** = Lot Code

## Notice

Specifications of the products displayed herein are subject to change without notice. TSC or anyone on its behalf, assumes no responsibility or liability for any errors or inaccuracies.

Information contained herein is intended to provide a product description only. No license, express or implied, to any intellectual property rights is granted by this document. Except as provided in TSC's terms and conditions of sale for such products, TSC assumes no liability whatsoever, and disclaims any express or implied warranty, relating to sale and/or use of TSC products including liability or warranties relating to fitness for a particular purpose, merchantability, or infringement of any patent, copyright, or other intellectual property right.

The products shown herein are not designed for use in medical, life-saving, or life-sustaining applications. Customers using or selling these products for use in such applications do so at their own risk and agree to fully indemnify TSC for any damages resulting from such improper use or sale.