



Assembly overview	2
1. Frame inspection	3
2. Headset installation	4
3. Cable housing installation & hydraulic routing.....	5-7
4. Electronic drive-train specification	8-12
5. Saddle adjustment	13-14
6. Derailleur hanger adjustment.....	15-19

For the warranty to be valid, the bicycle must be fully assembled by an authorized Argon 18 dealer. High end components, particularly carbon parts, need extra care when assembled. Those components must be installed using a calibrated torque wrench to make sure every bolt is at the right torque setting to prevent damage.



1. Frame inspection



2. Headset installation



3. Cable housing installation

IMPORTANT NOTICE: It is easier to install the cables and cable housings before the crank set.



4. Electronic drive-train cable routing specification



5. Seatpost adjustment



6. Derailleur hanger adjustment



When assembling a new frame, be sure to check if the following parts are assembled correctly.

Parts installed on the frame Description			Screw type	Tork Nm	Detail
1	Seatpost, Ø 27.2mm	Seatpost			Carbon paste
2	Front derailleur hanger	Screw	3mm	3Nm	Loctite
3	Rear derailleur hanger	Screw (2)	3mm	4Nm	Loctite
4	Bottle cage	Screw (4)	4mm	3Nm	Grease
5	Seatpost collar	Clamp	4mm	6Nm	Grease
6	Rear derailleur cable stopper	Screw (2)	2mm	2Nm	Loctite
7	Bottom bracket cable guide	Screw	5mm	3Nm	Grease



Install the 3D headset (6) according to the 3D headset assembly guide. You can choose from 3 different heights : 25mm, 15mm or 0mm.



A : barrel adjuster



B : plastic cap

speed adjustment : **B+A+B**



Install the front and rear derailleur cable starting at the top of the down tube.

For the derailleur and hydraulic housing, measure a sufficient length of housing to be able to turn the handlebar both ways correctly.

Suggested lengths of the cable housing

housing/size	XXS	XS	S	M	L	XL
Front brake	79cm	79cm	79cm	79cm	89cm	89cm
Rear brake	144cm	144cm	144cm	144cm	164cm	164cm
Front derailleur	138cm	140cm	142cm	144cm	146cm	148cm
Rear derailleur	196cm	198cm	200cm	202cm	204cm	206cm



Hydraulic brakes housing

Font section: Measure the necessary housing to ensure proper rotation of the handlebar. Insert the housing through the fork starting at the caliper.

Rear section: Remove both brake grommets (4j - front & rear). Run the hydraulic housing from the back of the bike to the front, and connect the housing to the lever as recommended by the brake manufacturer.

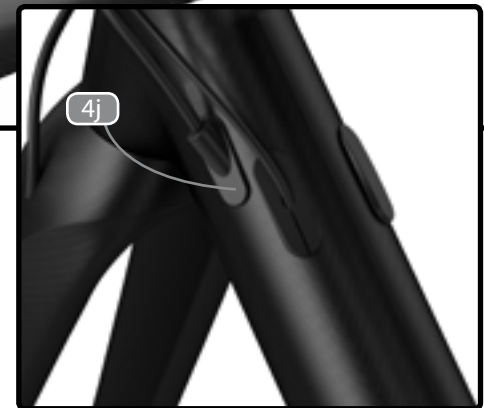



Front and rear derailleur: Pass the two cables inside the frame starting the top tube until they come out under the bottom bracket.

Pass both cables into the cable guide (4d). Make sure the 5mm screw is set to 1.5 Nm.

For a Di2 configuration, use the bottom bracket dedicated cover for electric shifting (4i).

It's better to install the cables before installing the bottom bracket and crank.



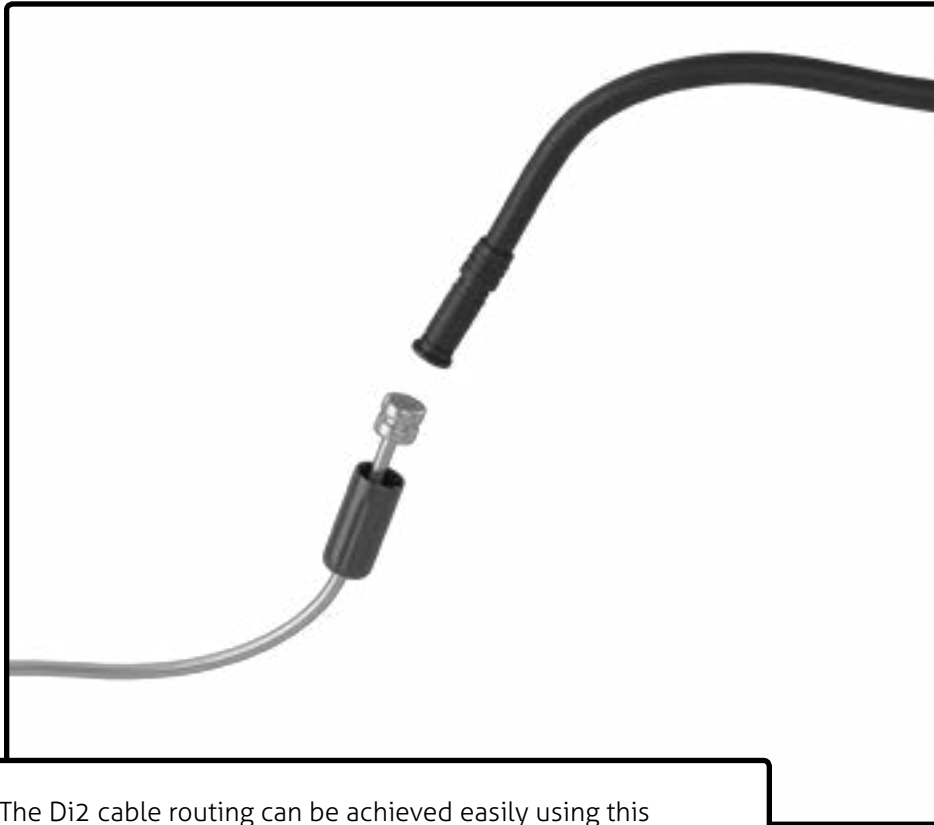

The Di2 cable routing can be achieved easily using this simple trick: use a brake cable and a metal cable end to fix the Di2 cable. For more information on Shimano Di2 electronic system installation, go to : <http://si.shimano.com>.

The same method can be use for hydraulic cable housing routing.

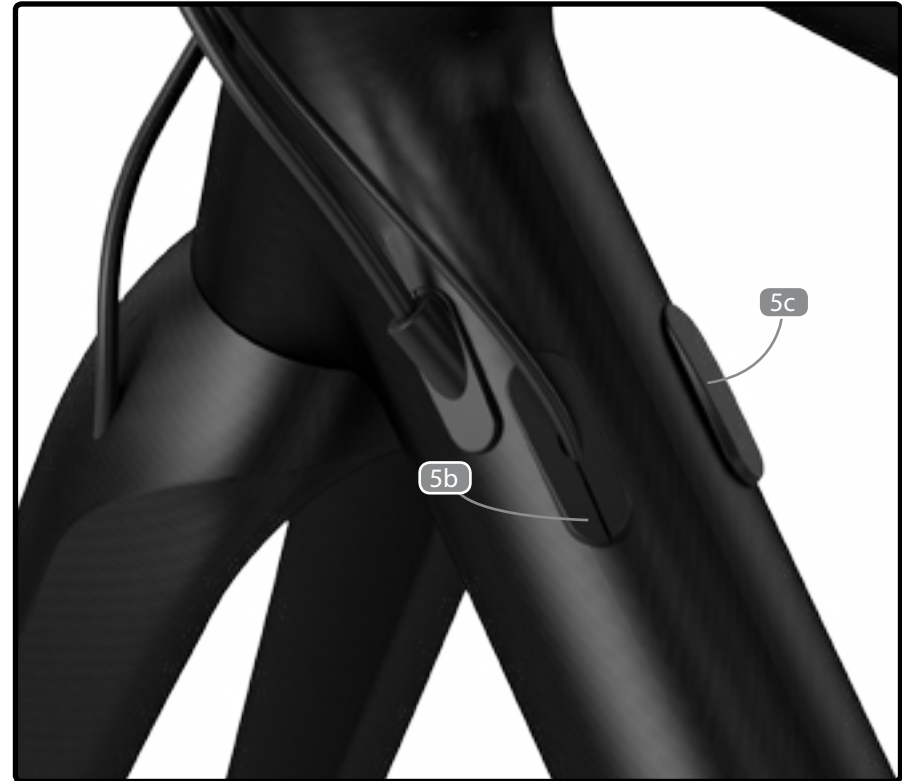
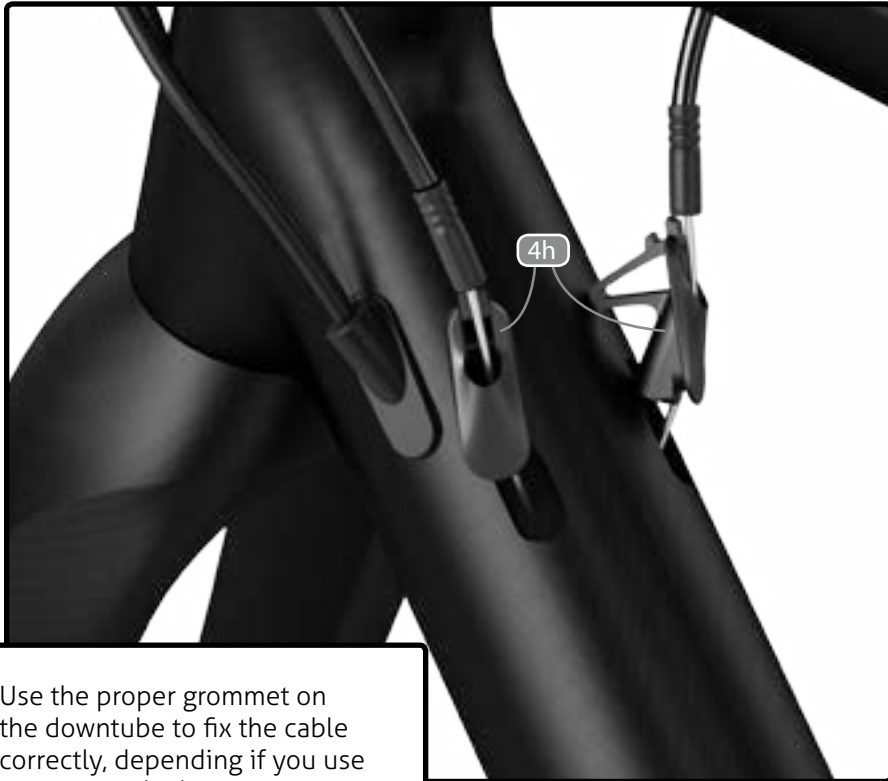

Use the proper grommet on the downtube to fix the cable correctly, depending if you use mechanical (4h) or electronic (5b-5c) drive-train.

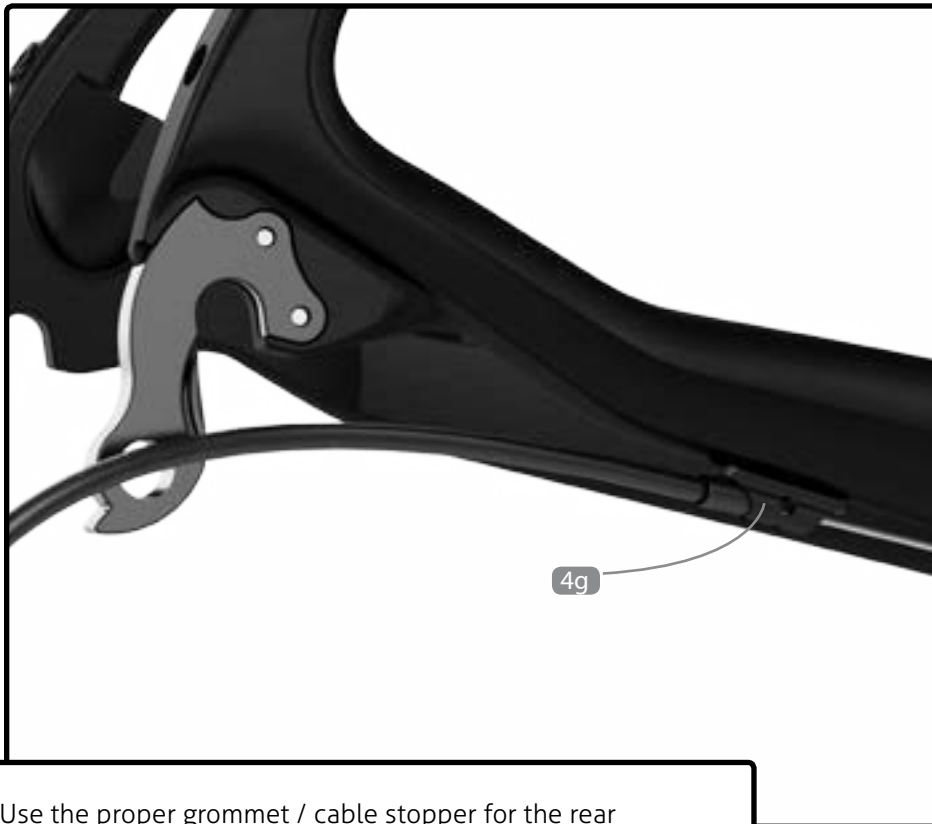

Use the proper grommet / cable stopper for the rear derailleur (depending if you use mechanical or electronic drive-train).

In a Di2 configuration, remove the cable stopper (4g) and use the Di2 grommet (5a) instead, but leave the 2 screws to avoid empty holes on the frame.



In a mechanical configuration, use the provided cable guide pipe (4f) for the front derailleur. For an electronic drive-train configuration, remove the cable guide pipe and use the proper grommet (5a) to fix the cable correctly.



The Di2 battery is hidden in the seatpost, use the 2 battery holders (8) to fix the battery correctly. Apply a slight amount of grease on both parts.

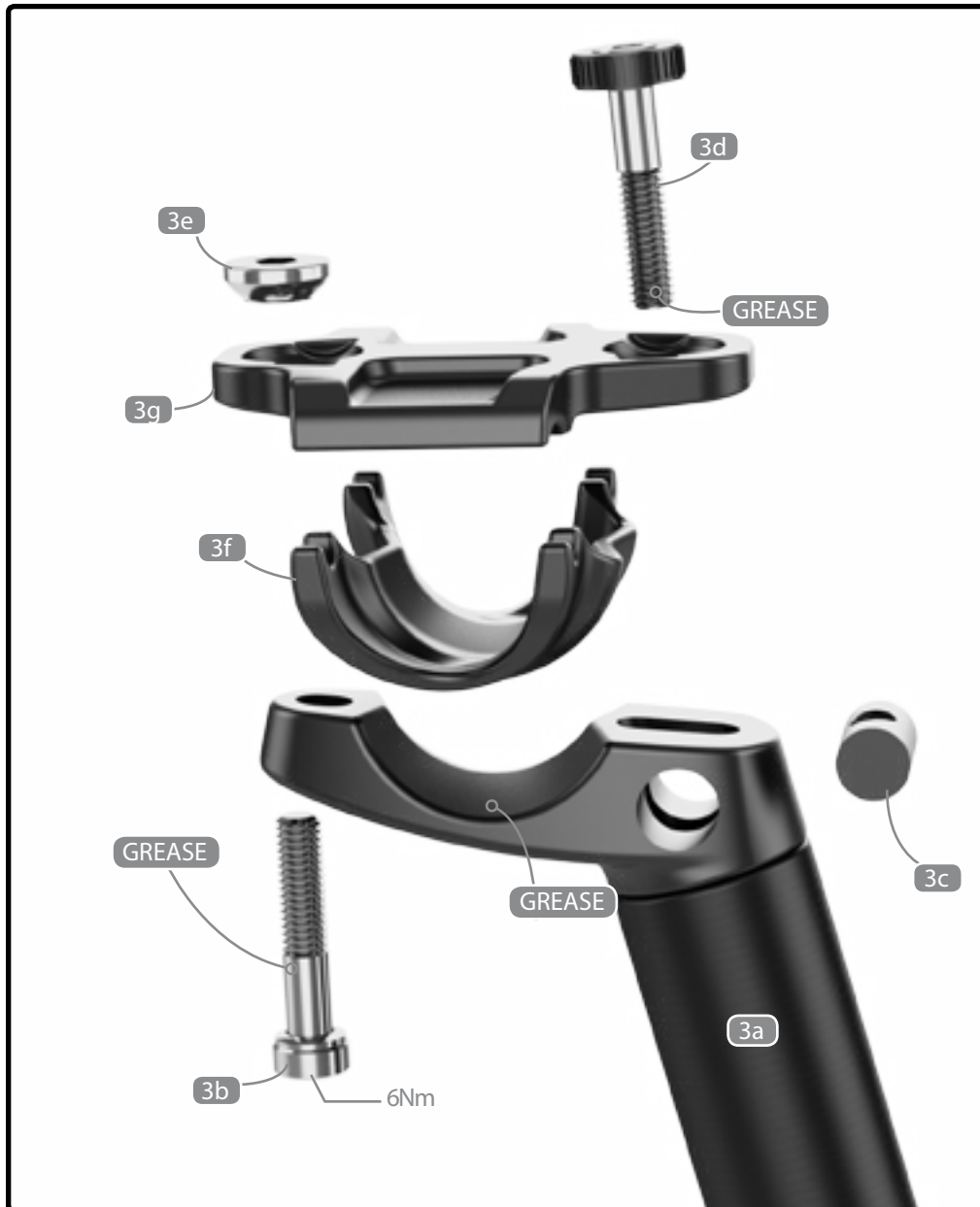

9.1 Install the saddle on the rocker (3f) and tighten the rail clamp (3g) using the screw (3d)

9.2 Adjust the angle, the offset of the saddle and tighten the bolt (3b).

9.3 The rocker and the rail clamp (3f-3g) can be flipped to change the saddle offset.



Seat clamp offset (5mm) by flipping the rail clamp (3g) and rocker (3f).



The front derailleur hanger can be adjusted according to the front derailleur angle to obtain an equal curve between the derailleur and the big chain ring. Once at the right angle, use blue 242 Loctite and screw in at 6Nm.

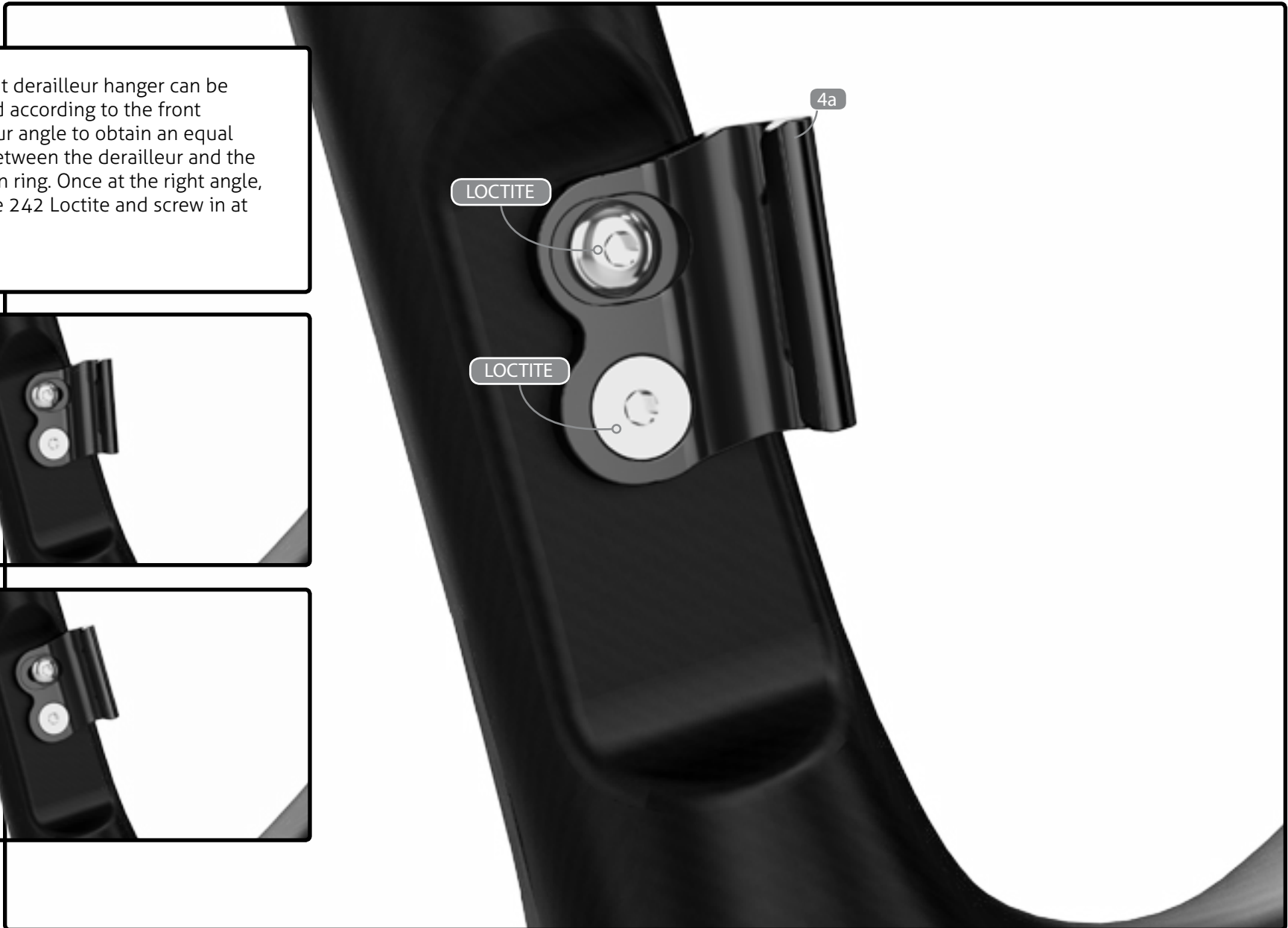





No #	Name	Supplier Description	Qty	SKU Comp	SKU Acc
Frameset parts					
1	Krypton frame (black matte)	AR-R06-UDG, artwork 213C, Black/white, matte			
2	Krypton fork (black/red matte)	AR-R06-FKF-43*305*56, artwork 213C-FK, Black/white, matte	1		38986
# Seat post with the following parts assembled					
3a	Krypton seat post (ASP-1600)	M-SP11-UDG-27.2*300 (with JD parts), artwork 212ASP-B, Black,matte	1		38763
3b	Hex cap screw (M6*40mm S)	M6*28mm	1		
3c	Cylinder nuts	SP24	2		
3d	SP special bolt (M6*45mm)	Special bolt M6*45mm, LD20100402	1		
3e	Convex M6 washer	Washer A2110-M	1		
3f	Rocker	SP107	1		
3g	Rail clamp	SP106	1		



No #	Name Frameset parts	Supplier Description	Qty	SKU Comp	SKU Acc
------	---------------------	----------------------	-----	----------	---------

#	Parts installed on the frame				
---	------------------------------	--	--	--	--

4a	Rear derailleur hanger with screws - Model C	RD125 rear DO hanger + RD125 rear DO hanger flat head HexSocket screws (M4*7mm F), black	1		37830
4b	Front derailleur hanger with screws - Model D	M-FD03 (R2) + ButtonHead HexSocket screw (M5*16mm B) and flat head HexSocket screw (M5*16mm F)	1		36197
4c	Seat clamp	SC137, seat clamp black polished + HexSocket screw (M5x20mm) and Ø5.3*Ø8.2*1mm(M5) washer	1		38256
4d	BB cable guide with screw	OS-368, BB cable guide with screw for AR-R03 and AR-R05, Flat head HexSocket (M5x16mm B)	1		38257
4e	Screw for water bottle cage	Stainless ButtonHead HexSocket screw (M5*16mm B) for bottle cages, M001E905038	4		38234
4f	BB cable guide pipe	OS-369-A, BB Cable guide pipe for AR-R03 and R05,	1		38258
4g	Removable CS cable stopper and screws	CS147, AR-R02 & AR-R01D2 CS removable cable stopper with flat head HexSocket screws (M3*10mm F), 0206F20006	3		36682
4h	Plastic Cable Stopper	CS177, Plastic Cable stopper	4		38756
4i	Di2 BB recess cover guide	OS-370, plastic recess cover for Di2 BB guide with screw for AR-R03, nut-117 round head Phillips (M5*9.5mm)	1		38260
4j	Hydraulic housing grommets		2		38894



No #	Name	Supplier Description	Qty	SKU Comp	SKU Acc
------	------	----------------------	-----	----------	---------

Di2 configuration specific parts

5a	FD & RD wire grommet	CCN009-1, Cable Di2 Grommet round flat	1		38891
5b	Downtube Di2 Grommet	CS-189, Downtube Di2 Grommet	1		38892
5c	Downtube Di2 Grommet filler	CS-190	1		38893

Also included with the frameset - shipped separately

6	No. 53-1 +3D w/TH-881-1 without crown race	NO.53-1+3D (Argon 18 exclusive), Anodized Black 1 1/4w/E0247/8,MW170A/B without crown race	1	38953	38954
7	3D headset tool	3D head tube tool, 2012 w/3D head tube logo, with hole, width 33.5mm	1	36165	36919
8	Di2 Battery holder	DIS-22, Seatpost battery mount for AR-R03C and AR-R05, 27.2mm	1	38446	38448