

ARIES™



**2016 JEEP® PRODUCTS CATALOG
& APPLICATION GUIDES**

INTENTIONALLY BLANK



ARIES DEALER PORTAL

Access free marketing resources and order from our easy, new online ordering system!

At ARIES, we want to give you the tools you need to successfully market the ARIES brand and further your business. As such, we are proud to introduce our Dealer Portal. This online dealer-exclusive site is a one-stop shop for ordering ARIES parts and downloading all our latest marketing resources.

The ARIES Dealer Portal allows you to:

- Look up parts by vehicle and order them using a single username and password
- Access product content, photography, videos and more
- Download up-to-date vehicle application data

For more information, please contact our Development Team at websupport@curtmfg.com.



2015 Jeep Wrangler

CHANGE BODY STYLE

CHANGE COLOR

START OVER



Select part to display on vehicle

17 Results Show all



ARIES AUTOMOTIVE
Modular Bumper

Details



ARIES AUTOMOTIVE
Modular Bumper

Details



ARIES AUTOMOTIVE
Rocker Steps

Details



ARIES AUTOMOTIVE
Tube Doors

Details



ARIES AUTOMOTIVE
Fender Flares

Details

envision™ ARIES CONFIGURATOR

Let your customers 'try on' ARIES with the most advanced online vehicle customizer!

Envision™ ARIES is an interactive, digital vehicle customization tool that lets your customers view any ARIES accessory, fully installed, on any vehicle, from the comfort and convenience of their own computer or device. They simply select the year, make and model, specify the style and color, and then select one or more ARIES accessories to preview.

This powerful, new tool features:

- Over 5,000 vehicles with years ranging from 1915 to 2016
- A spectrum of vehicle colors, styles and lifts
- A connection to our dealers through Where to Buy

Envision™ ARIES is available on ariesautomotive.com and is available for your customers to use on your own website. For more information, please contact our Development Team at websupport@curtmfg.com.



NEW IMAGERY, CONTENT & DATA

Implement our growing content resources in your store and on your website!

ARIES has undergone some major changes recently, refocusing our marketing strategies and customer support efforts. In addition to video, we have refined and expanded our photo library, written content and vehicle application data.

We have built an extensive photo library, consisting of professional product images, in-use images and lifestyle shots. We have expanded our written content offering,

including rich product descriptions, bullet points and more. We have also refined our application data to make it easy for our customers to find the products they are looking for.

All of these resources are available for you to use on your website and in printed materials. They can be accessed through the ARIES Dealer Portal at ariesautomotive.com, using our FTP server and Reporting tool.

Scan to view our
YouTube channel

Connect with us!



UNMATCHED VIDEO LIBRARY

Show your customers the ARIES difference with our expanding video resources!

With a new, professional video team at our headquarters, ARIES is in the process of building a library of videos to support our dealers, installers and consumers. We offer installation videos, product feature videos and more, to show our customers the benefits of ARIES products. We now have over 50 videos, with new ones added every week.

Our entire video library is available to use in your store and on your website. They can be accessed in following ways:

- youtube.com/AriesAutomotive
- FTP server via the Dealer Portal
- ariesautomotive.com

For more information about embedding ARIES videos on your website or to obtain hard copies for use in your store, contact our video team at videos@curtmfg.com.

NEW PRODUCTS

At ARIES, we pride ourselves on offering something different – something that no one else in our industry has and that will keep our customers coming back for more. We are always working toward new innovations by listening to our customers and focusing on their passion.

For 2016, we are pleased to present several new products that will further set ARIES apart. Our new Jeep® products include our rocker steps, fender flare side markers and winch fairlead mount. We have also introduced an entirely new category with our fast, lightweight AeroTread™ running boards.

Jeep® Rocker Steps



Jeep® rocker steps offer more than extra side protection. With their wide, flat profile and heavy-duty design, they offer a solid step, plenty of ground clearance and added protection on the trail. They are constructed with high-strength steel and shielded in a textured black powder coat finish. **Page 54**



Jeep® Fender Flare Side Markers



Jeep® side markers easily mount onto the side of our Jeep® fender flares and provide bright, DOT-approved, LED lights. The LED components are long-lasting and are able to be spliced directly into the existing factory harness for a seamless installation. **Page 59**



Winch Fairlead Mount

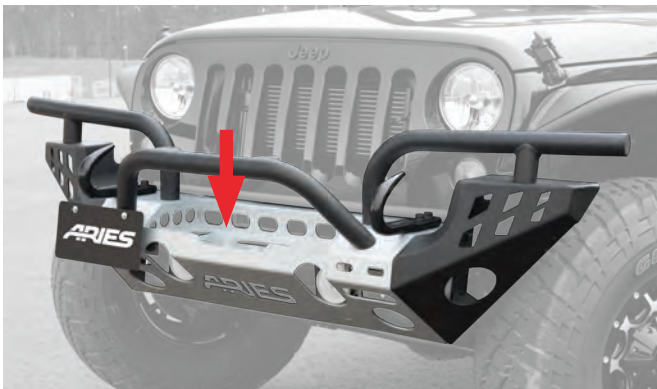

The winch fairlead mount easily and securely mounts onto our modular Jeep® bumper winch housing and offers two sets of mounting holes to accept most types of fairleads. It is made with 1/4" thick steel and protected with a durable carbide powder coat finish. **Page 67**



AeroTread™ Running Boards



AeroTread™ running boards are sleek and lightweight to accent the latest crossover or SUV. They feature an extruded aluminum base and full-length, non-skid treads. They mount using vehicle-specific brackets and come in two front trim finish options: polished stainless or black carbide. **Page 34**





PRODUCT INDEX

When it comes to automotive accessories, ARIES has the variety and quality your customers are looking for. We offer custom-fit, vehicle-specific bull bars, grille guards, side bars and running boards, as well as a full line of custom Jeep® products.

Our specialty lines are packed with ARIES-exclusive features and patented designs to give you the aftermarket edge. So whether they will be ruling the road or charging off it, get your customers ready for the drive with ARIES Automotive.

| | | | |
|--|----|---|----|
| 3" Bull Bars | 22 | Jeep® Security Cargo Lid | 60 |
| 3" Bull Bar Accessories | 23 | Jeep® Third Brake Light Extension Bracket | 69 |
| 3" Pro Series™ Round Side Bars | 40 | Jeep® Tire Relocation Carrier and Brackets | 69 |
| 3" Round Side Bars | 42 | Jeep® Tow Hook | 67 |
| 4" Big Step™ Round Side Bars | 38 | Jeep® Tube Bumpers | 62 |
| 4" Oval Side Bars | 36 | Jeep® Tube Doors | 56 |
| 5" AeroTread™ Running Boards | 34 | Jeep® Winch Fairlead Mount | 67 |
| Grille Guards | 30 | Jeep® Winch Receiver Plate Bracket | 67 |
| Jeep® Accessories | 66 | Jeep® Windshield Light Brackets | 69 |
| Jeep® Fender Flares | 58 | Literature | 82 |
| Jeep® Fender Flare Side Markers | 59 | Marketing Materials | 80 |
| Jeep® License Plate Bracket | 68 | Pro Series™ Grille Guards | 26 |
| Jeep® Modular Bumper, Accessories | 52 | Pro Series™ Grille Guard Cover Plates | 28 |
| Jeep® Modular Bumpers, Front | 48 | Pro Series™ Grille Guard Light Bar Brackets | 28 |
| Jeep® Modular Bumpers, Rear | 50 | Removable Universal Mud Flaps | 64 |
| Jeep® Modular Bumper Replacement Parts | 50 | Seat Defender™ | 72 |
| Jeep® Rocker Steps | 54 | StyleGuard™ Floor Liners | 74 |
| Jeep® Roof Light Bar | 66 | | |

TABLE OF CONTENTS

AUTO ACCESSORIES GUIDE **08 - 17**

PRO SERIES™ **18 - 19**

BULL BARS **20 - 23**

GRILLE GUARDS **24 - 31**

SIDE BARS & RUNNING BOARDS **32 - 43**

JEEP PRODUCTS **44 - 69**

INTERIOR PROTECTION **70 - 79**

MARKETING MATERIALS **80 - 88**

AUTO ACCESSORIES GUIDE

The automotive accessories industry is ever changing and expanding with new designs, tech and terminology. As the ARIES product line continues to expand, we want our customers to stay fully informed and knowledgeable about our products.

The ARIES Auto Accessories Guide is a basic guide to our products and offers helpful information associated with the industry. It lays out the differences between our various products, what advantages they offer you and your customers, and it provides details about various terms used in our application guide.

In addition to the following sections, we have arranged a list of terms and definitions that are used in this catalog, on our website, in our installation instructions and throughout our other marketing materials. While these terms are used consistently within ARIES and widely across the industry, they may not reflect those used by other brands and manufacturers.

MATERIALS AND FINISHES

ARIES Automotive offers products that come in a wide variety of materials and finishes. There is no single finish to satisfy every need, taste and preference, and without knowing the differences, it can be difficult to help your customers make a purchasing decision.

The following guide describes some of the key characteristics and advantages of each material and finish we use in our products. It also lists some of the products associated with each to help you determine which products will best suit your customers.

MATERIALS

/ 201 stainless steel

This type of stainless steel is relatively harder than other types of stainless and offers good overall rust resistance, especially when properly coated. As an alternative to the polished stainless steel look, it provides a solid black finish option that can withstand moisture and road salt, making it a preferred choice for cold-weather climates.

/ 304 stainless steel

This variation of stainless steel is higher in nickel content, allowing it to be very resilient to rust and corrosion. It is used in a number of ARIES products, from grille guards to side bars, and typically comes with a mirror-like polished finish. We also use 304 stainless in our bull bar skid plates to keep them free from rust despite frequent exposure to moisture, dirt and debris. 304 stainless steel is the ideal choice for anyone who prefers the look of polished stainless over black.

/ Carbon steel

Perhaps the most common type of steel, carbon steel is preferred for its high strength, and ARIES carbon steel is cold rolled to add even more strength and hardness. Though it is not highly rust-resistant, carbon steel can easily be preserved with the right powder coat finish. Carbon steel is used for a variety of ARIES products, including our Pro Series™ accessories and removable mud flaps. It is the all-around steel of choice for adding extra strength and durability.

/ T6 aluminum alloy

Aluminum is commonly known to be lightweight and rust-free, making it an ideal material for truck accessories. T6 aluminum, however, provides an additional advantage by going through a heat treatment process to increase its overall hardness. We use T6 aluminum in many of our Jeep®-specific accessories, as well as in our Big Step™ side bars. It is the ideal material for off-roading, being completely free of rust and keeping excessive weight off the vehicle.

FINISHES

/ Polished stainless



With a mirror-like finish, polished stainless steel adds a bright accent to any accessory. Though not all polished stainless finishes are necessarily highly rust-resistant, the polished stainless steel

offered by ARIES is a 304 stainless, meaning it has a large percentage of nickel content to be truly rust-resistant. This allows the polished finish to maintain its flawless, mirror-like appearance despite the elements and changing seasons. Polished stainless steel is available on a number of ARIES products, including many of our grille guards, bull bars and side bars.

/ Brushed stainless



A brushed finish is created by treating a metal surface with an abrasive. It has a somewhat grainy appearance compared to a polished finish and offers a unique texture, helping to

hide minor scratches and imperfections. All ARIES bull bar skid plates are made with brushed 304 stainless steel to maintain a consistent finish in spite of nicks, scratches and scuffs from road debris. Brushed stainless is an excellent choice on and off the road, helping to protect and preserve the vehicle's front end.

/ Semi-gloss black powder coat

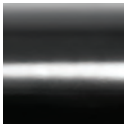

Semi-gloss black powder coat is polyester-based to be durable and rust-resistant. It is typically applied to carbon steel products and is designed to withstand moisture, scratches,

chipping and peeling over time. Our semi-gloss black is also UV-resistant to help prevent fading. Like polished stainless, we offer this finish on several of our products, from grille guards to side bars.

/ Silver powder coat



Similar to our chrome powder coat, this finish offers a bright metallic look without being overly lustrous. It is also designed to be very durable, resisting scratches, peeling and rust.

The silver powder coat finish is specifically offered as an option for our aluminum modular bumpers, and it is intended to work well alongside our textured black powder coat finish.

/ Textured black powder coat

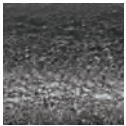

Textured black has a wrinkled-like appearance that is specially designed to hide scratches, grime and dirt. Because of this characteristic, textured black is an ideal choice for off-road

and work vehicles. We also put our textured black powder coat through an extensive salt spray test to ensure the best possible corrosion resistance in any season. Textured black is used on our Pro Series™ products, Big Step™ side bars and several of our Jeep® accessories.

BULL BARS VS GRILLE GUARDS

The ARIES front end line includes both bull bars and grille guards. When helping your customers decide which accessory to select for their Jeep®, it is important to know some of the differences.



/ Bull bars

A bull bar is generally designed with an A-shaped frame, consisting of a main outer tube and a center, horizontal tube or crossbar. The main tube extends up from the underside of the vehicle to cover a portion of the bumper and even the grille on certain models. Typically, a bull bar bolts onto the vehicle's frame and covers just the center portion of the vehicle's bumper and grille.

Many bull bars come with a crossbar that can accept aftermarket lights, as well as a skid plate that attaches to the lower portion of the frame to deflect stones and other small road debris.

Bull bars are different from grille guards in that they:

- Generally cover less area than grille guards
- Do not have side brush guards to cover the headlights
- Usually come with a skid plate

/ Grille guards

If bull bars have an A-shaped frame, grille guards could be said to have an H-shaped frame. A grille guard (sometimes referred to as a brush guard) is essentially made up of two vertical members, called risers, and a center, horizontal member, called a crossbar or center flange. The risers are usually equipped with mounting holes to attach the grille guard to the frame.

Most grille guards also have a pair of side brush guards attached to the risers that extend outward to protect the vehicle's headlights, as well as a top tube and bottom tube spanning between the risers.

Like on a bull bar, the grille guard crossbar is typically designed to accept aftermarket lights, whether using pre-drilled holes or an LED light bar housing such as on the ARIES Pro Series™ grille guard.

Grille guards are different from bull bars in that they:

- Generally cover a large portion of the front end
- Have brush guards to protect the headlights
- Do not have a skid plate

SIDE BARS VS RUNNING BOARDS

For 2016, ARIES has introduced several new side accessories including an entirely new category of 'Running Boards'. With this new product category, it is important to understand the differences between side bars and running boards to better serve your customers.



/ Side bars

Side bars are referred to by many names, including nerf bars, step bars and side steps, to name a few. A side bar's primary function is to provide a stepping surface into the vehicle. For this reason, they are generally used on vehicles that ride high off the ground. However, for aesthetic value, they are also found on smaller vehicles, such as compact SUVs and crossovers.

Side bars are typically designed to mount with a certain amount of space between the step and the body of the vehicle. This amount of space can vary, depending on the model, but in general, it is a few inches. They are also designed to mount low on the vehicle, allowing for less ground clearance, compared to running boards, but providing a more functional step for lifted vehicles. Side bars also usually have individual, custom step pads to correspond to each door on the vehicle, and they are generally narrower than running boards.

Side bars are different from running boards in that they:

- Leave extra space between the bar and the vehicle
- Offer reduced ground clearance for an easier step on lifted vehicles
- Feature individual, custom-placed step pads
- Typically have a narrower width than running boards

/ Running boards

Like a side bar, a running board provides a stepping surface into the vehicle. However, it generally mounts flush against the vehicle's rocker panel, instead of leaving a gap. Running boards are also typically wider than side bars and have an overall flat top surface. Instead of individually placed step pads, the flat stepping surface usually has a tread that spans the length of the board.

Running boards are found on everything from larger SUVs to smaller crossovers, providing a convenient step and additional aesthetic value. Unlike side bars that mount down and away from the vehicle, running boards typically offer more ground clearance, making them an excellent choice for lower vehicles.

Running boards are different from side bars in that they:

- Mount relatively flush against the rocker panel
- Offer more ground clearance for lower vehicles
- Feature a single, full-length tread
- Typically have a wider, flatter profile

ADVANTAGES OF THE TRACK MOUNTING SYSTEM

/ AeroTread™



Several ARIES side accessories use a track mounting system, including our new AeroTread™ running boards.

A track mounting system uses two key components: a channel or set of channels and sliding bolts or C-shaped brackets. The channel allows the bolts to slide along the board and typically spans much of its length to allow for flexible positioning. The boards can then be bolted onto vehicle-specific mounting brackets already attached to the vehicle.

This mounting system provides some key advantages. Unlike running boards with fixed mounting locations, the track mounting system allows one board to be used on multiple vehicle. This reduces inventory requirements, allowing room for more product. The track mounting system also makes installation easier. Because the bolts can slide along the channel, they can be precisely positioned and can easily accept nuts for a secure attachment.

ROCKER MOUNT VS BUSHING MOUNT

/ Rocker mount



All ARIES side bars and running boards mount using vehicle-specific brackets. This allows for easier and more secure installation. In addition to a vehicle-specific fit, there are two types of side bar / running board installations: rocker mount and bushing mount.

A rocker mount, also called a rocker panel mount, uses the vehicle's rocker panel to attach the mounting brackets. This may be done using pre-existing welded bolts on the vehicle, clip nuts or other fasteners. In general, side bars with 45° bent ends install using the rocker mount method.

/ Bushing mount



A bushing mount, on the other hand, attaches the mounting brackets to the vehicle using a set of pre-existing bolts on the vehicle, called bushing bolts. These bolts are installed on the vehicle by the manufacturer, and serve to anchor the body to the chassis. When installing side bars or running boards, these bushing bolts can be removed and reinstalled to hold the mounting brackets. A bushing mount is typically used for side bars with 90° bent ends.

MUD FLAPS

A mud flap is an accessory typically found on Jeeps® used for off-roading. It is essentially a thick rubber flap that mounts behind each rear tire and is intended to keep mud, stones and other debris from being projected into the wheel wells and behind the vehicle.



Because mud flaps may be illegal on main roads in some states, certain mud flaps, such as ARIES universal removable mud flaps, are designed for quick attachment and detachment as needed. To learn about the laws concerning mud flaps in your state, the State Patrol is a good resource.

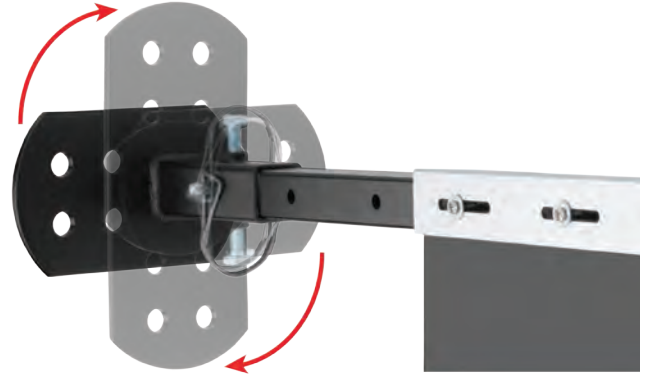

A GUIDE TO JEEP® CUSTOMIZATION

Building (that is, customizing a vehicle with aftermarket accessories) has almost become an art form for today's Jeep® owner. The Jeep® Wrangler has particularly been a choice model for this hobby. The key to a great build is having the flexibility to add more and more accessories, and that is why the ARIES Jeep® line is diverse and innovative, giving your customers a wide selection to keep building and fueling their passion.



/ Customized look

For building a customized look, modular bumpers feature a six-piece, interchangeable design with up to 16 different configurations. Our modular bumpers, tube bumpers and roof light bar are also excellent choices for adding aftermarket lights. We also provide vehicle-specific grille guards and bull bars for various Jeep® models.



/ Ultimate off-roader

For building the ultimate off-roader, we carry tube doors, fender flares and our removable mud flaps with no drilling needed on the Jeep® JK. Our modular bumper accepts tow hooks and a winch for functionality on the trail. To keep your customers' items secure, our security cargo lid offers a fully lockable enclosure that integrates with the layout of the Jeep®.



/ Modular bumper design

Modular is simply a term used to describe accessories that have interchangeable pieces to allow for different combinations. For example, the ARIES Jeep® modular bumper is made up of a center section, two side extensions, a center brush guard and two side brush guards. Each piece individually attaches to the center section, meaning it can be added, left off or replaced with a different piece or finish to suit individual preference.

The modular design of the ARIES Jeep® bumper allows your customers to create different looks for their Jeep®, without needing to buy an entirely new accessory. They can start with one of 16 different base configurations, and then add, remove or swap out pieces as desired. See page 46 for a full listing of ARIES Jeep® modular bumpers.



/ Rocker steps

New for 2016, ARIES Jeep® rocker steps offer extra side protection and a convenient step up. While many rocker panel protectors are simple steel panels or tubes, ARIES Jeep® rocker steps have a wide, flat profile that provides two key advantages. First, it offers a convenient, comfortable step up into the Jeep®. The double-tube layout and welded top plate create a sturdy, 3" wide stepping surface. Second, the flat design offers added ground clearance. Unlike some side bars that are mounted down and away from the vehicle, ARIES rocker steps are set high enough to clear brush, boulders and other off-road debris. They also feature a durable textured black powder coat finish to resist rust and hide scratches and grime. See page 54 for more.



/ Security cargo lid

The ARIES Jeep® security cargo lid is the perfect line of defense for your customer's items. This integrated security system turns the rear cargo area of the off-roading Jeep® Wrangler (4-door models only) into a fully lockable, key-operated storage enclosure. It not only allows your customers to keep items under lock and key while they're away, but it also helps protect them from the elements. The lid works with the layout of the Jeep® and with the rear door. It also features tie-down anchors and a 75-lb. weight capacity to accept additional cargo on top. The ARIES Jeep® security cargo lid is made from strong aluminum alloy and has a highly durable textured powder coat finish to easily resist the elements.



/ Tube doors and fender flares

For stylizing the off-road machine, we offer tube doors and fender flares. ARIES tube doors feature an open design with an aggressive cutout pattern. They use the existing factory hinge brackets for easy mounting and are available for both the front and rear. The doors are made with hardened T6 aluminum construction and have a textured black powder coat finish to easily resist scratches and grime. Likewise, ARIES Jeep® fender flares add style and off-road readiness to your customer's Wrangler. They feature a 4" width and custom contours to show well with larger, off-road tires. With hardened T6 aluminum construction and a textured powder coat finish, these fender flares are made to go off road.

AUTO ACCESSORIES GLOSSARY

A

Aftermarket

a term used to refer to automotive parts and accessories that fit a particular vehicle but are made by a manufacturer different than the original equipment manufacturer or OEM

All-Wheel Drive (AWD)

a drivetrain system that powers all four wheels simultaneously, all of the time; provides more traction when needed but generally will not activate until the vehicle requires it, making some automatic all-wheel drive vehicles essentially smart 2WD systems; different from four-wheel drive in that 4WD can be switched off by the driver

Application Guide

a complete index of current part numbers and associated vehicle applications for all ARIES parts; available online or in the ARIES catalog

B

Bench Seat

a type of vehicle seat that spans the width of the vehicle and provides seating for three or more persons; can be in the first row, but is commonly found in the rear passenger rows

Body

the external structure of a vehicle that gives it its recognizable shape; may be bolted to the chassis or combined as a single molded piece

Brush Guard

see 'Grille Guard'; may refer to the tubular attachment or extension of other front end accessories, such as the ARIES Jeep® modular bumper

Bucket Seat

a type of vehicle seat designed to hold only one person; typically used for the first row and sometimes second row

Bull Bar

a type of front end accessory, usually with an A-shaped frame, that bolts directly onto the vehicle and covers a center portion of the vehicle's bumper and grille

Bushing Bolt

a heavy-duty fastener used to anchor a vehicle's body to its chassis; can sometimes be used as an attachment point for side bars, running boards or other side accessories

Bushing Mount

a mounting style of side bars and running boards that uses the vehicle's bushing bolts to attach the mounting brackets; typically used for side bars with 90° bends and commonly used on aftermarket side bars as opposed to OEM

C

Chassis

the main framework of a vehicle, consisting of the frame and essential parts needed for operation (excludes the body); can be a unibody design, with the chassis and bodywork as a single piece, or with a C-frame construction

Clip Nut

a type of nut with an attached spring clip that allows it to be clipped onto the edge of an opening and held in place while a bolt is threaded through; frequently used for mounting points that are difficult to reach

Crossbar

the main center section of a front end accessory, such as a bull bar or grille guard, to which aftermarket lights and other accessories may be attached

Cross-Linked Polyethylene (XPE) Foam

a fine-celled material comprised of linked polymer chains that provide increased hardness and rigidity, and offer characteristics of thermal insulation, waterproofing, shock absorption and sound insulation

Crossover Utility Vehicle (CUV)

also known simply as a 'crossover'; a vehicle that is built on a car platform using features and styling common on sport utility vehicles (SUV)

CUV

see 'Crossover Utility Vehicle'

D

Denier

a measurement of fabric weight, based on the fineness or thickness of the threads

Drivetrain

the set of parts in an automobile that allows the engine to channel its power to the axles; typically includes the driveshaft, CV joints, differential, axle shafts and U-joints

Dual Post

a floor liner attachment method that uses two knobs or posts, usually positioned on the driver's side near the seat, to help keep the floor liner held in place; also see 'Single Post'

F

Four-Wheel Drive (4WD)

a drivetrain system in which all four wheels of the vehicle are powered by the engine simultaneously; different from all-wheel drive in that it can be disengaged by the driver so that the vehicle operates on a two-wheel drive system only

Frame

the part of a vehicle that serves as the base to which all other parts attach

G

Grille Guard

also called a 'brush guard'; a type of front end accessory that bolts directly onto the vehicle and usually covers a large portion of the vehicle's profile, including the grille and headlights; typically has a center section, consisting of a crossbar and two risers, as well as two side brush guards to cover the headlights

L

LED (Light-Emitting Diode)

a semiconducting light source that requires less amperage for illumination than a traditional light bulb

M

Modular

a term applied to accessories that are able to be constructed with various, interchangeable pieces to produce different combinations; applies to ARIES Jeep® modular bumpers, see page 46

N

Nerf Bar

see 'Side Bar'

O

Original Equipment Manufacturer (OEM)

a term used to designate parts that are made by the original manufacturer as opposed to an aftermarket manufacturer

R

Risers

also known as 'uprights'; the vertical members of a grille guard that make up the main frame, together with the crossbar, and which provide mounting points to attach the grille guard to the vehicle; typically protected with rubber stripping on the front edges

Rocker Mount

also called a 'rocker panel mount'; a mounting style of side bars and running boards that uses the vehicle's rocker panel to attach the mounting brackets; may use welded bolts on the vehicle, clip nuts or other fasteners; typically used for side bars with 45° bends and commonly used on OEM side bars as opposed to aftermarket options

Rocker Panel

the side body panel on a vehicle, below the doors, spanning from wheel to wheel; can sometimes be used as an attachment point for side bars, running boards or other side accessories

Rocker Panel Mount

see 'Rocker Mount'

Running Board

a type of vehicle side accessory that provides a stepping surface into the vehicle and is generally mounted flush against the body; typically wider than a side bar and equipped with a tread that spans almost the full length of the board

S

Side Bar

sometimes referred to as a 'nerf bar', 'step bar' or 'side step'; a type of vehicle side accessory that provides a stepping surface into the vehicle and is mounted with a certain amount of space between the step and the body; typically has individual step pads to correspond to each vehicle door

Side Marker

a small light mounted on either side of a vehicle to make it more visible to other drivers on the road; required by law; typically wired to illuminate with the vehicle's taillights and parking lights

Side Step

see 'Side Bar'

Single Hook

a floor liner attachment method, similar to 'Single Post', but using a hook instead of a knob, to help keep the floor liner held in place

Single Post

a floor liner attachment method that uses one knob or post, usually positioned on the driver's side near the seat, to help keep the floor liner held in place; also see 'Dual Post'

Sport Utility Vehicle (SUV)

a type of automotive vehicle with a station-wagon-like body built on a light truck chassis; usually equipped with four-wheel drive for on- or off-road capability

Step Bar

see 'Side Bar'

Sub Frame

the part of a vehicle that supports the engine and front suspension on a unibody frame

SUV

see 'Sport Utility Vehicle'

T

Terylene

a highly durable fabric that is made of synthetic polyester and characterized by its light weight and resistance to creasing

Thermoplastic rubber (TPR)

a material consisting of a combination of plastic and rubber and having properties of both, being flexible, moldable, durable, waterproof and resilient to extreme temperatures

Torque

a measurement of the turning force on an object such as a bolt or a flywheel (e.g. pushing or pulling the handle of a wrench when tightening a bolt)

Torque Wrench

a type of wrench that indicates to the user how much torque is being applied when turning the ratchet; used when a specific amount of torque must be applied to a fastener

Tow Hook

a large metal hook designed to be mounted on the front or rear of a vehicle, usually on the bumper, for straight-line towing purposes; typically used in combination with a tow strap

Track Mounting System

a type of mounting system for side bars and running boards that uses a channel and sliding bolts or brackets to attach to vehicle-specific mounting brackets; the channel typically spans the length of the accessory to allow for flexible positioning; helps reduce inventory requirements by allowing one accessory to fit multiple vehicles

Two-Wheel Drive (2WD)

a drivetrain system in which the engine powers only two of the vehicle's wheels; common on most non-commercial vehicles without four-wheel drive

U

Unibody Frame

a type of vehicle frame in which the bodywork and chassis are made up of a single molded piece; usually has a sub-frame on the front end to hold the engine and suspension

Uprights

see 'Risers'

V

Vehicle Identification Number (VIN)

a unique serial number used by the automotive industry to identify individual motor vehicles

VIN Tag

a metal plate or sticker on a vehicle or trailer that provides vital information about the vehicle, including the make, model, year, weight ratings and the VIN

W

Weld Nut

a type of nut that is welded to a metal surface on a vehicle and allows a bolt to be fastened directly to the surface without an additional nut

Wheelbase (WB)

the horizontal distance between the center of the front wheel and the center of the rear wheel on a vehicle

X

XPE Foam

see 'Cross-Linked Polyethylene (XPE) Foam'

PRO SERIES™



FIND OUT WHAT IT MEANS TO BE A PRO

The ARIES Pro Series™ represents a higher class of auto accessories, reserved for those who see their ride as more than just four wheels and a cab. It includes our patented Pro Series™ grille guard, with a single-row LED light bar housing, and Pro Series™ side bars to allow your customers

to completely upgrade the look of their Jeep®. All Pro Series™ products feature high-strength carbon steel construction, a tested, textured black powder coat finish and a three-year warranty.



Pro Series™ grille guard

The ARIES Pro Series™ grille guard is unlike any other grille guard or brush guard on the road today because of its patented center crossbar. The unique crossbar is able to house a single-row LED light bar, allowing your customers to truly set their Jeep® apart. See page 26 for more.

- Patented crossbar houses a single-row LED light bar (bar not included)
- Interchangeable cover plates offer quick and easy customization
- Tested, textured black powder coat easily hides scratches and dirt
- One-piece, 1 1/2" diameter, heavy-wall tube design



Pro Series™ side bars

ARIES Pro Series™ side bars are a step above the rest, featuring 3" diameter, heavy-wall construction and custom, raised, non-skid step pads. Each set of side bars is designed with vehicle-specific contours and mounts with heavy-duty steel brackets. See page 40 for more.

- 3" diameter, heavy-wall tube design
- Raised, custom, non-skid step pads
- Brushed stainless steel ARIES insignia
- No-drill, vehicle-specific application for a custom fit

BULL BARS

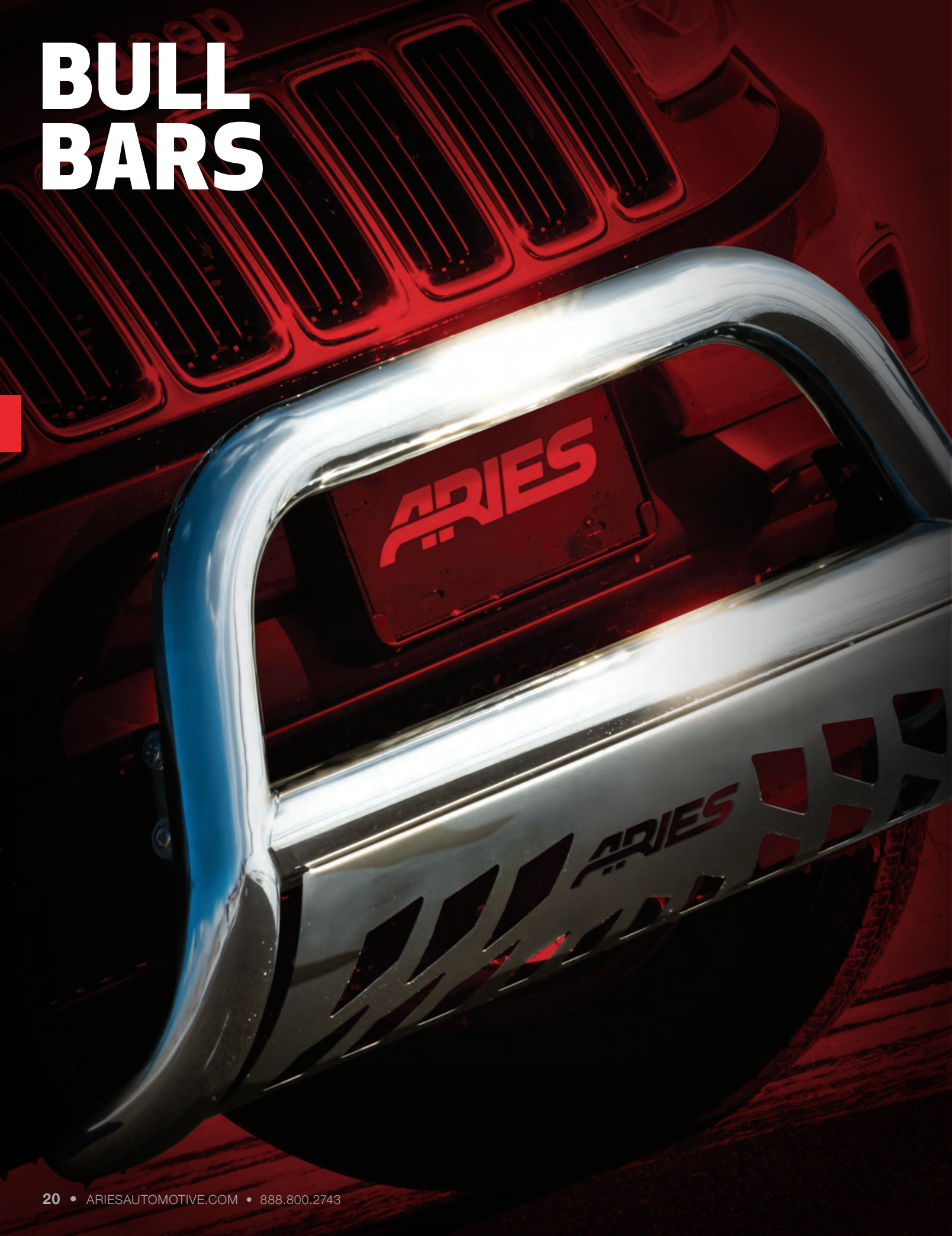



KEEP THAT STIFF UPPER LIP

From the cattle rancher on the open range, to the industrial man of the asphalt jungle, to the jaw-clenching off-roader of the backwoods, ARIES bull bars are made for those who face the uncertain road without fear.

Built with heavy-duty steel tube construction, our 3" bull bars are designed to withstand the rugged environment of a hardworking lifestyle. They feature a vehicle-specific design and an easy, no-drill application for quick installation on your customer's Jeep®.

Our 3" bull bars are available for Jeep® applications in two finishes, including polished 304 stainless steel and semi-gloss black carbon steel. They also come with pre-drilled auxiliary light holes along the crossbar and a removable skid plate for easy customization.



Vehicle-specific fit

All ARIES bull bars use pre-existing holes on the vehicle to cut down on installation time, eliminate drilling and offer maximum strength and rigidity



Auxiliary light mounts

With a pre-drilled crossbar each ARIES bull bar can easily be customized with auxiliary lights, including round lights up to 5 1/2" in diameter and LED light bars



Multiple finishes available

ARIES bull bars come in two finishes for Jeep®, including polished stainless and semi-gloss black carbon. See page 8 to learn more about our finishes

CATEGORY INDEX

22 | **3" Bull Bars**

3"

BULL BARS

with a vehicle-specific fit for each application

/ Pre-drilled crossbar

The crossbar has two pre-drilled holes to securely mount auxiliary lights, including round lights up to 5 1/2" in diameter and LED light bars

/ Removable skid plate

The brushed stainless steel skid plate protects the front and underside of the Jeep® and can be removed for a custom look

/ Vehicle-specific fit

Each application uses unique mounting brackets and pre-existing factory holes to eliminate drilling and reduce installation time

Features and benefits

- 3" diameter, heavy-wall tube design
- Pre-drilled crossbar for mounting auxiliary lights
- Removable, brushed stainless steel skid plate deflects small road debris
- No-drill, vehicle-specific application for a custom fit
- Three-year warranty on black finish and limited lifetime warranty on polished stainless



B35-9003

Material and finish options

Bull bar

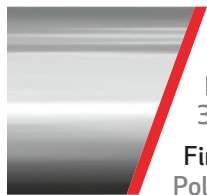

Material:
304 stainless steel

Finish:
Polished stainless

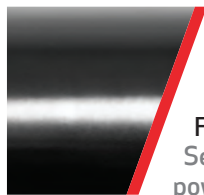

Material:
Carbon steel

Finish:
Semi-gloss black powder coat

Skid plate



Material:
304 stainless steel

Finish:
Brushed stainless

APPLICATION GUIDE

| 3" Bull Bars | | | | |
|----------------|---------------|---------|------------|----------|
| Make / Model | Style / Notes | Years | Stainless# | Black# |
| Commander | All | 06 - 11 | 35-1001 | B35-1001 |
| Grand Cherokee | All | 05 - 07 | 35-1001 | B35-1001 |
| | All | 11 - 16 | 35-1003 | B35-1003 |



3" BULL BAR ACCESSORY

License plate bracket



35-0000

- Easily bolts onto 3" crossbar, using existing skid plate hardware
- Provides a solid mounting location to keep license plate visible
- Steel construction with black powder coat finish
- Includes two license plate mounting bolts

GRILLE GUARDS





DARE TO CONQUER NEW TERRAIN

It wasn't the easy road that made your customers choose their Jeep®. They chose it because there was new territory to be explored, wilderness to be tamed and terrain to be conquered.

For the conqueror in every Jeep® owner, ARIES grille guards are available for a variety of applications. Each one is built vehicle-specific, not just to eliminate drilling and speed up installation, but because your customers expect a custom fit.

For those who dare to go even further, the Pro Series™ grille guard is unlike any other. Its patented crossbar is able to house an LED light bar and features an interchangeable cover plate to protect and add a custom look.

Don't make them settle. Give your customers confidence by giving them ARIES.



Pro Series™ grille guard

The Pro Series™ grille guard can accept one or more single-row LED light bars up to 20" long, using the patented crossbar housing and channel-style bracket



Patented light mounts

With a patented LED light bar housing on our Pro Series™ grille guards and a pre-drilled crossbar on our standard models, these grille guards make customization easy



Vehicle-specific fit

All ARIES grille guards use pre-existing holes on the vehicle to cut down on installation time, and many use a four-point mounting system for increased rigidity

CATEGORY INDEX

26 | **Pro Series™ Grille Guards**

28 | **Pro Series™ Cover Plates**

30 | **Grille Guards**

PRO SERIES™ GRILLE GUARD

with a patented, customizable LED light bar housing

/ Patented crossbar

One or more single-row LED light bars, up to 20" in total length, can be mounted using the articulating, channel-style bracket

/ Customizable cover plate

The included black mesh cover plate keeps the light bar protected from theft and damage and can be swapped out for a custom look

/ Vehicle-specific fit

The 1/4" thick risers and 1 1/2" mandrel-bent steel tubing contour to the profile of the Jeep® for seamless integration

Features and benefits

- Patented crossbar houses a single-row LED light bar (light bar not included)
- Interchangeable cover plate protects the light bar and offers easy customization
- Channel-style bracket accepts one or multiple light bars
- Articulating bracket allows light to be mounted at a custom angle
- Tested, textured black powder coat easily hides scratches and dirt
- One-piece, 1 1/2" diameter, heavy-wall tube design
- High-strength carbon steel construction
- Protective rubber stripping along the risers
- Complements other ARIES Pro Series™ accessories
- No-drill, vehicle-specific application for a custom fit
- Pro Series™ grille guard patent# US9108581B2
- All Pro Series™ grille guards come standard with the black mesh cover plate #PJ20MB
- Three-year warranty



Material and finish

Grille guard

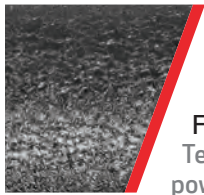

Material:
Carbon steel

Finish:
Textured black powder coat

Cover plate (included)

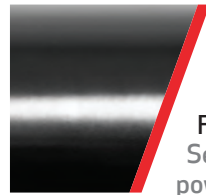

Material:
Carbon steel

Finish:
Semi-gloss black powder coat

APPLICATION GUIDE

| Pro Series™ Grille Guard | | | |
|--------------------------|---------------|---------|-------|
| Make / Model | Style / Notes | Years | Part# |
| Wrangler | All | 07 - 16 | P1050 |



PRO SERIES™ GRILLE GUARD ACCESSORIES

License plate bracket



85-0000

- Easily bolts onto the crossbar, using included hardware
- Provides a solid mounting location to keep license plate visible
- Steel construction with black powder coat finish
- Includes license plate mounting bolts

Interchangeable cover plates



See page 28 for options

- Easily swapped out for instant customization
- Available in multiple styles and finishes
- Protects light bars from theft and the elements
- Securely bolts onto the patented center crossbar
- All cover plate part numbers listed on page 28

PRO SERIES™ GRILLE GUARD COVER PLATES

with an interchangeable design for easy customization

A key feature of the patented Pro Series™ grille guard is its unique light bar housing and mounting bracket. The channel-style bracket accepts one or more single-row light bars, up to 20" in total length. This means multiple combinations can be used, such as one 20" or two 7". The crossbar housing keeps the light bars well protected from theft and damage.

To take customization even further, the Pro Series™ grille guard can also accept different crossbar cover plates. While each Pro Series™ grille guard comes standard with a black mesh cover plate, we offer replacements in two styles and three finishes to let your customers choose the look that best suits their Jeep®.

Material and finish options

Cover plate

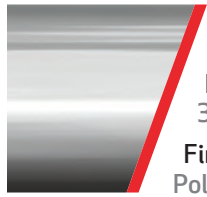

Material:
304 stainless steel
Finish:
Polished stainless



Material:
304 stainless steel
Finish:
Brushed stainless

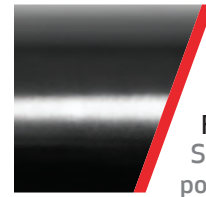

Material:
Carbon steel
Finish:
Semi-gloss black powder coat

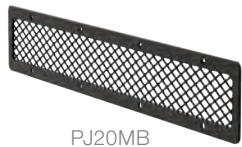

PJ20MB

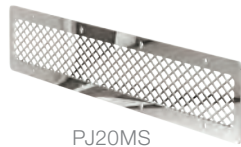

PJ20MS



PJ20OB

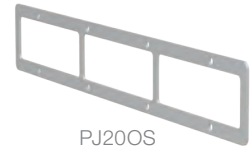

PJ20OS



| Pro Series™ Cover Plates | | | | |
|--------------------------|-----------|--------|-----------|----------|
| Light Bar Length | Style | Black# | Polished# | Brushed# |
| 20" | Mesh-face | PJ20MB | PJ20MS | -- |
| 20" | Open-face | PJ20OB | -- | PJ20OS |

REPLACEMENT LIGHT BAR MOUNTING BRACKET

- Accepts most single-row LED light bars up to 20" long
- Channel-style mounting system for flexible installation options
- Articulating design allows light to be mounted at a custom angle
- Included with all Pro Series™ grille guards
- Light bar not included



PR20 - 20"



GRILLE GUARDS

with a vehicle-specific fit for each application

/ Customizable design

The crossbar has two pre-drilled holes to accept auxiliary lights, and the headlight cages can be removed for a custom look

/ Vehicle-specific fit

The 1/4" thick risers and 1 1/2" mandrel-bent steel tubing contour to the profile of each specific vehicle for seamless integration

/ Simple, secure mounting

The risers bolt onto pre-existing factory holes in the vehicle's frame to eliminate the need for drilling and ensure a solid mount

Features and benefits

- One-piece, 1 1/2" diameter, heavy-wall tube design
- Pre-drilled crossbar for mounting auxiliary lights
- Removable headlight cages for a custom look
- Protective rubber stripping along the risers
- No-drill, vehicle-specific application for a custom fit
- Three-year warranty on black finish

Material and finish options

Grille guard

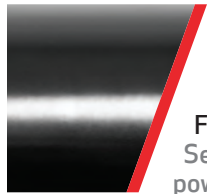

Material:
Carbon steel

Finish:
Semi-gloss black
powder coat





APPLICATION GUIDE

| Grille Guards | | | | |
|----------------|--------------------------|---------|-------|--|
| Make / Model | Style / Notes | Years | Part# | |
| Cherokee | Excl. Limited | 86 - 00 | 1043 | |
| Commander | All | 06 - 11 | 1048 | |
| Grand Cherokee | All | 05 - 10 | 1046 | |
| | Excl. SRT and Trail Hawk | 11 - 15 | 1052 | |
| | Tow hook only | 99 - 04 | 1044 | |
| | Tow hook only (4WD only) | 95 - 98 | 1042 | |
| Liberty | No headlight cage | 08 - 12 | 1051 | |
| | All | 05 - 07 | 1047 | |
| | Excl. Renegade | 02 - 04 | 1045 | |
| Sport | Excl. Limited | 86 - 00 | 1043 | |
| Wrangler | No headlight cage | 07 - 16 | 1050 | |

SIDE BARS & RUNNING BOARDS





STEP UP AND STAND OUT

When your customers start and end their day turning the ignition of their Jeep®, unreliable footing isn't an option. For the serious Jeep® owner, side bars aren't there just to look pretty. They're there to take a boot to the face every single day, and look pretty doing it.

New for 2016, ARIES AeroTread™ running boards are sleek and lightweight, providing an aerodynamic accent for the modern SUV. They feature full-length treads, an aluminum base and two finish options.

ARIES side bars are also available in two different diameters, two tube profiles and multiple finishes, including polished 304 stainless steel and textured black aluminum. We offer side bars for several Jeep® models, and each comes with vehicle-specific brackets for a custom fit.



NEW AeroTread™

Made with an aluminum base, new AeroTread™ running boards feature a front trim piece in two finish options: polished stainless steel or black carbide powder coat



Track mounting system

Using vehicle-specific mounting brackets and a track-type mounting system, ARIES running boards are made for easy, no-drill installation and a custom fit

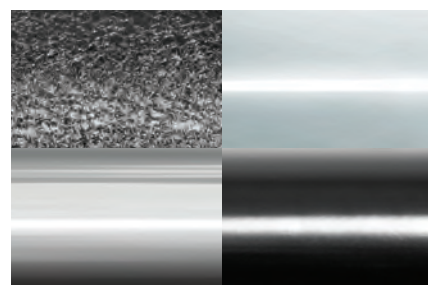

Variety of finishes

ARIES side bars come in an array of finishes, including textured black aluminum and polished 304 stainless steel. See page 8 to learn more about our finishes

CATEGORY INDEX

34 | **5" AeroTread™**

36 | **4" Ovals**

38 | **4" Big Step™ Round**

40 | **3" Pro Series™ Round**

42 | **3" Round**

5"

AEROTREAD™ RUNNING BOARDS

NEW

for a sleek, fast, lightweight accent on the modern SUV

/ Sleek design

The vehicle-specific fit, curved edges, tapered ends and aerodynamic tread pattern add a sleek accent to today's SUVs and compact SUVs

/ Lightweight build

The aluminum base provides a solid, lightweight, rust-free step and is covered in a front trim piece, available in two finishes

/ Full-length tread

The hard plastic step pad runs the entire length of the board, providing a non-skid surface no matter where you place your foot

Features and benefits

- Sleek design with rounded ends to complement the look of modern SUVs
- Extruded aluminum base to be lightweight and rust-free
- Flat profile and 5" width provide a comfortable step
- Full-length, tough plastic tread offers a reliable, non-skid surface
- Universal track mounting system for easy, secure installation
- Vehicle-specific mounting brackets for a precise fit
- Sold in pairs with mounting brackets sold separately
- Three-year warranty



Material and finish options

Running boards



Base material:
Aluminum alloy

Front trim material:
304 stainless steel

Front trim finish:
Polished stainless

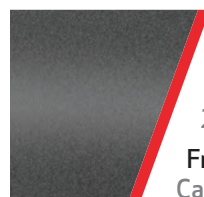

Base material:
Aluminum alloy

Front trim material:
201 stainless steel

Front trim finish:
Carbide black powder coat

APPLICATION GUIDE

| 5" AeroTread™ Running Boards & Mounting Brackets | | | | |
|--|---------|----------|------------|---------|
| Make / Model | Years | Bracket# | Stainless# | Black# |
| Grand Cherokee | 10 - 15 | 2051139 | 2051867 | 2051967 |
| Compass | 14 - 15 | 2051134 | 2051867 | 2051967 |
| Cherokee | 14 - 15 | 2051132 | 2051870 | 2051970 |
| Patriot | 07 - 15 | 2051135 | TBD | TBD |



UNIVERSAL TRACK MOUNTING SYSTEM

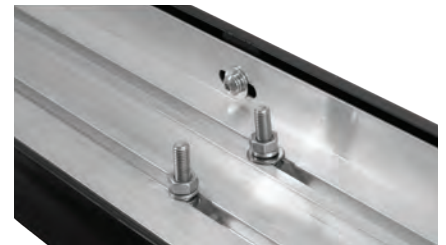

AeroTread™ running boards come in four base lengths, including 67", 70", 73" and 76", to take up less inventory space and allow for easier ordering. To ensure a custom fit for every application, the running boards install using

a track mounting system and vehicle-specific mounting brackets. Using the application guide, determine the board length and bracket part number that will fit your customer's specific vehicle.

4"

OVAL SIDE BARS

with seamlessly blended ends for a unique, finished look

/ Unique finished look

The 30° bends and seamlessly blended end caps offer a superior, finished look to competitive straight tubes and plastic end caps

/ Raised step pads

The tough polypropylene step pads provide an extra-wide, non-skid surface and are custom-positioned to match the vehicle layout

/ Vehicle-specific fit

Each side bar has vehicle-specific bends and mounting brackets to contour to the Jeep® and install quickly with no drilling required

Features and benefits

- 30° bends to contour to the body of the Jeep®
- Seamless, welded end caps for a superior, finished look
- Raised, custom, non-skid step pads
- Brushed stainless steel ARIES insignia on each step
- Elliptical, 4" wide, heavy-wall tube design
- No-drill, vehicle-specific application for a custom fit
- Sold in pairs with installation hardware included
- Heavy-duty steel mounting brackets
- Three-year warranty on black finish and limited lifetime warranty on polished stainless



Material and finish options

Side bars

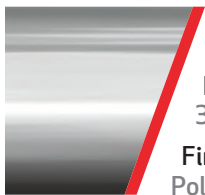

Material:
304 stainless steel
Finish:
Polished stainless

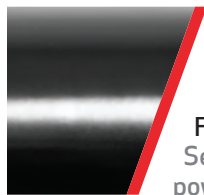

Material:
Carbon steel
Finish:
Semi-gloss black powder coat

APPLICATION GUIDE

| 4" Oval Side Bars | | | | |
|-------------------|-------|---------|------------|---------|
| Make / Model | Style | Years | Stainless# | Black# |
| Grand Cherokee | All | 11 - 15 | S221008-2 | S221008 |



4"

BIG STEP™ ROUND SIDE BARS

to give that Wrangler a real riding partner

/ Bold design

The 4" diameter and 1/8" thick walls are made to accent the style of the Jeep® Wrangler for both 2-door and 4-door models

/ Lightweight aluminum build

Aluminum construction is strong, rust-free and 40% lighter than carbon steel, making it ideal for both off-roading and hard work

/ Raised step pads

The tough polypropylene step pads provide an extra-wide, non-skid surface and are custom-positioned to match the vehicle layout

Features and benefits

- Bold, 4" diameter is designed to show well on the Jeep® Wrangler
- Hardened T6 aluminum construction to be lightweight and rust-free
- Textured black powder coat easily hides scratches and dirt
- Raised, custom, non-skid step pads
- Brushed stainless steel ARIES insignia on each step
- Unique bends to contour to the body of the Jeep®
- No-drill, vehicle-specific application for a custom fit
- Sold in pairs with installation hardware included
- Heavy-duty steel mounting brackets
- Five-year warranty



Material and finish

Side bars

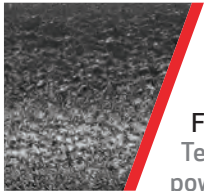

Material:
T6 aluminum alloy

Finish:
Textured black powder coat

APPLICATION GUIDE

| 4" Big Step™ Round Side Bars | | | |
|------------------------------|--------|---------|----------|
| Make / Model | Style | Years | Black# |
| Wrangler | 2-door | 07 - 16 | AL231008 |
| | 4-door | 07 - 16 | AL231007 |



3"

PRO SERIES™ ROUND SIDE BARS

with a textured black finish that won't back down

/ Tested finish

The textured powder coat easily hides scratches and is put through an extensive salt spray test to ensure durability in any season

/ Raised step pads

The tough polypropylene step pads provide an extra-wide, non-skid surface and are custom-positioned to match the vehicle layout

/ Vehicle-specific fit

Each side bar has vehicle-specific bends and mounting brackets to contour to the vehicle and install quickly with no drilling required

Features and benefits

- Tested, textured black powder coat easily hides scratches and dirt
- Raised, custom, non-skid step pads
- 3" diameter, heavy-wall tube design
- High-strength carbon steel construction
- Brushed stainless steel ARIES insignia on each step
- Unique bends to contour to the body of the Jeep®
- Complements other ARIES Pro Series™ accessories
- No-drill, vehicle-specific application for a custom fit
- Heavy-duty steel mounting brackets
- Sold in pairs with installation hardware included
- Three-year warranty



Material and finish

Side bars

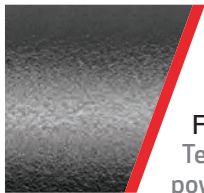

Material:
Carbon steel

Finish:
Textured black
powder coat

APPLICATION GUIDE

| 3" Pro Series™ Round Side Bars | | | |
|--------------------------------|--------|---------|--------|
| Make / Model | Style | Years | Part# |
| Wrangler | 2-door | 07 - 16 | P35800 |
| | 4-door | 07 - 16 | P35700 |



X
RANGLER
UNLIMITED

3"

ROUND SIDE BARS

with a vehicle-specific fit for each application

/ E-coat finish

In addition to a durable powder coat, our carbon steel side bars get an E-coat finish for added chip, scratch and peel resistance

/ Custom step pads

The tough polypropylene step pads provide a textured, non-skid surface and are custom-positioned to match the vehicle layout

/ Vehicle-specific fit

Each side bar has vehicle-specific bends and mounting brackets to contour to the vehicle and install quickly with no drilling required

Features and benefits

- No-drill, vehicle-specific application for a custom fit
- Unique bends to contour to the body of the Jeep®
- Custom, non-skid step pads
- 3" diameter, heavy-wall tube design
- Heavy-duty steel mounting brackets
- Sold in pairs with installation hardware included
- Three-year warranty on black finish and limited lifetime warranty on polished stainless



Material and finish options

Side bars



Material:
304 stainless steel
Finish:
Polished stainless

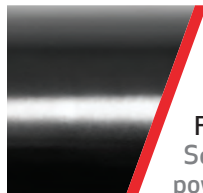

Material:
Carbon steel
Finish:
Semi-gloss black powder coat



APPLICATION GUIDE

| 3" Round Side Bars | | | | | |
|--------------------|--|---------|------------|--------|--|
| Make / Model | Style / Notes | Years | Stainless# | Black# | |
| Cherokee | All | 84 - 00 | 201000-2 | 201000 | |
| Grand Cherokee | All | 99 - 04 | 201001-2 | 201001 | |
| | All | 05 - 10 | 201003-2 | 201003 | |
| | All | 11 - 15 | 201008-2 | 201008 | |
| Liberty | Without mud flaps | 02 - 06 | 201002-2 | 201002 | |
| | All | 08 - 12 | 201005-2 | 201005 | |
| | Excl. Sport (without mud flaps) | 05 - 07 | 201002-2 | 201002 | |
| Patriot | All | 07 - 15 | 201009-2 | 201009 | |
| Unlimited | All | 87 - 06 | 35600-2 | 35600 | |
| Wrangler | 2-door (will not work with factory rocker) | 07 - 16 | 35800-2 | 35800 | |
| | 4-door (will not work with factory rocker) | 07 - 16 | 35700-2 | 35700 | |
| YJ Wrangler | All | 87 - 06 | 35600-2 | 35600 | |

JEEP® PRODUCTS





TAKE THINGS OFF THE BEATEN PATH

At ARIES, we know what it means to be a Jeep® owner. From our modular bumpers and tube doors to our security cargo lid and fender flares, our complete line of Jeep®-exclusive products reflects the same passion your customers have for going off the beaten path.

New for 2016, ARIES Jeep® rocker steps offer more than extra side protection. With their wide, flat profile and heavy-duty design, they offer a solid step up, plenty of ground clearance and protection from scratches and dents.

Never let your customers settle for Jeep® accessories that are unworthy to bear the name. Give them freedom on the trail with Jeep® products from ARIES.



NEW Jeep® rocker steps

Unlike side bars, new ARIES Jeep® rocker steps are designed to offer more ground clearance to be off-road ready. They not only offer extra protection but also a solid step up



Easy customization

ARIES Jeep®-exclusive products make it easy for your customers to achieve that customized look, whether they want the entire package right away or prefer to build one piece at a time



Solid construction

Most of our Jeep®-exclusive products are made from hardened T6 aluminum with a textured black finish to be strong, rust-free and keep your customer's Jeep® light on its feet

CATEGORY INDEX

46 | **Modular Bumpers**

54 | **Rocker Steps**

56 | **Tube Doors**

58 | **Fender Flares**

60 | **Security Cargo Lid**

62 | **Tube Bumpers**

64 | **Removeable Mud Flaps**

66 | **Jeep Accessories**

JEEP[®] MODULAR BUMPERS

with a mix-and-match design for ultimate customization

/ Customizable configuration

The modular design allows pieces to be added to the center section as desired, making it easy to find the right look and change it any time

/ Lightweight build

Constructed with 3/16" T6 aluminum and 100% TIG welds, the aluminum option is strong, lightweight and rust-free for ready off-roading

/ Multiple accessory options

With light mounting tabs and cutouts, tow hook attachment points and a 22 1/2" x 7 3/4" winch housing, adding accessories is easy

Features and benefits

- Six-piece customizable design with 16 different configurations (see page 48 for more information)
- Modular pieces can be added or removed as desired
- Hardened T6 aluminum construction to be lightweight and rust-free (also available in carbon steel)
- Cutouts and light mounting tabs for OE bumper lights and auxiliary lighting
- Accepts tow hooks and a winch (aluminum requires winch bracket #15600WRB)
- Mid configuration with side caps available for larger tires or wheel wells
- Fits 2007 - 2016 Jeep[®] Wrangler JK
- Uses pre-existing factory mounting points for easy installation
- Front and rear bumpers available
- Five-year warranty on aluminum bumpers and three-year warranty on steel

Material and finish options

Center section

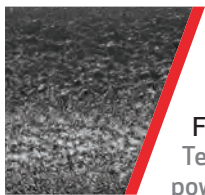

Material:
Carbon steel
Finish:
Textured black powder coat

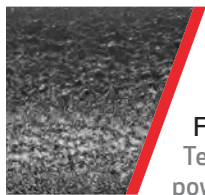

Material:
T6 aluminum alloy
Finish:
Textured black powder coat



Material:
T6 aluminum alloy
Finish:
Silver powder coat

Side extensions

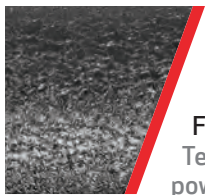

Material:
Carbon steel
Finish:
Textured black powder coat

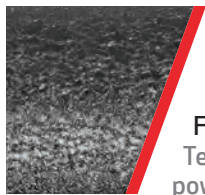

Material:
T6 aluminum alloy
Finish:
Textured black powder coat

Brush guards

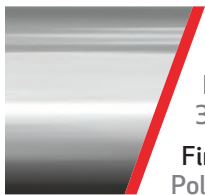

Material:
304 stainless steel
Finish:
Polished stainless

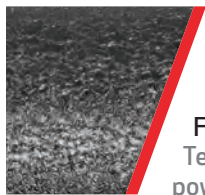

Material:
Carbon steel
Finish:
Textured black powder coat

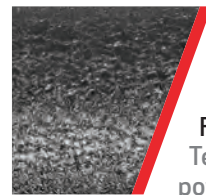

Material:
T6 aluminum alloy
Finish:
Textured black powder coat

Protective brush guards easily bolt onto sides and center section

Light mounting tabs for off-road lights

Side extensions can be swapped out for side caps

Universal winch housing
22 1/2" x 7 3/4"

Cutouts and mounting tabs for additional lights

Front and rear center sections use existing mounting points

Light mount cutouts for OE fog lights

2071051

Left and right bumper side extensions

Rear cutouts allow for dual exhaust

Light mount cutouts for OE lights

Center cutout allows for rear mount trailer hitch

FULL-CONFIG FRONT MODULAR BUMPER KITS

/ Steel construction



2071030



2071031



2071032

/ Aluminum construction



2071023



2071024



2071020



2071021



2071022

Full-Config Front Modular Bumper Kits

| Kit Part# | Center Section | Side Extensions | Brush Guards | Center and Side Material | Center Finish | Side Finish | Brush Guard Material | Brush Guard Finish |
|-----------|----------------|-----------------|--------------|--------------------------|---------------|-------------|----------------------|--------------------|
| 2071030 | 15600-0 | 15600-1 | 15600-4 | Steel | 2 | 2 | Steel | 2 |
| 2071031 | 15600-0 | 15600-1 | 15600-4-2 | Steel | 2 | 2 | Stainless steel | 1 |
| 2071032 | 15600-0 | 15600-1 | -- | Steel | 2 | 2 | -- | -- |
| 2071023 | AL15600-0 | AL15600-1 | -- | Aluminum | 2 | 2 | -- | -- |
| 2071024 | AL15600-0-3 | AL15600-1 | -- | Aluminum | 3 | 2 | -- | -- |
| 2071020 | AL15600-0 | AL15600-1 | AL15600-4 | Aluminum | 2 | 2 | Aluminum | 2 |
| 2071021 | AL15600-0 | AL15600-1 | 15600-4-2 | Aluminum | 2 | 2 | Stainless steel | 1 |
| 2071022 | AL15600-0-3 | AL15600-1 | AL15600-4 | Aluminum | 3 | 2 | Aluminum | 2 |

1. Polished stainless steel

2. Textured black powder coat

3. Silver powder coat

MID-CONFIG FRONT MODULAR BUMPER KITS

/ Steel construction



2071033



2071034



2071035

/ Aluminum construction



2071028



2071029



2071025



2071026



2071027

Mid-Config Front Modular Bumper Kits

| Kit Part# | Center Section | Side Caps | Brush Guard | Center and Side Material | Center Finish | Side Finish | Brush Guard Material | Brush Guard Finish |
|-----------|----------------|------------|-------------|--------------------------|---------------|-------------|----------------------|--------------------|
| 2071033 | 15600-0 | C15600-1 | 15600-5 | Steel | 2 | 2 | Steel | 2 |
| 2071034 | 15600-0 | C15600-1 | 15600-5-2 | Steel | 2 | 2 | Stainless steel | 1 |
| 2071035 | 15600-0 | C15600-1 | -- | Steel | 2 | 2 | -- | -- |
| 2071028 | AL15600-0 | ALC15600-1 | -- | Aluminum | 2 | 2 | -- | -- |
| 2071029 | AL15600-0-3 | ALC15600-1 | -- | Aluminum | 3 | 2 | -- | -- |
| 2071025 | AL15600-0 | ALC15600-1 | AL15600-5 | Aluminum | 2 | 2 | Aluminum | 2 |
| 2071026 | AL15600-0 | ALC15600-1 | 15600-5-2 | Aluminum | 2 | 2 | Stainless steel | 1 |
| 2071027 | AL15600-0-3 | ALC15600-1 | AL15600-5 | Aluminum | 3 | 2 | Aluminum | 2 |

1. Polished stainless steel

2. Textured black powder coat

3. Silver powder coat

REAR MODULAR BUMPER KITS



2071052



2071050



2071051

Rear Modular Bumper Kits

| Kit Part# | Center Section | Side Extensions | Center Material | Center Finish | Side Finish |
|-----------|----------------|-----------------|-----------------|---------------|-------------|
| 2071052 | 25600-0 | 25600-1 | Steel | 2 | 2 |
| 2071050 | AL25600-0 | AL25600-1 | Aluminum | 2 | 2 |
| 2071051 | AL25600-0-3 | AL25600-1 | Aluminum | 3 | 2 |

2. Textured black powder coat 3. Silver powder coat

MODULAR BUMPER REPLACEMENT PIECES

/ Brush guards



15600-4 & AL15600-4



15600-4-2



15600-5



15600-5-2

Front Modular Bumper Replacement Brush Guards

| Part# | Material | Finish |
|--|-----------------|-----------------|
| Full Configuration - Center and Side Brush Guards | | |
| 15600-4 | Steel | Textured black |
| 15600-4-2 | Stainless steel | Stainless steel |
| AL15600-4 | Aluminum | Textured black |
| RA15600-4* | Aluminum | Raw aluminum |
| Mid Configuration - Center Brush Guards | | |
| 15600-5 | Steel | Textured black |
| 15600-5-2 | Stainless steel | Stainless steel |

* Raw aluminum (available by special order)

/ Side extensions and side caps

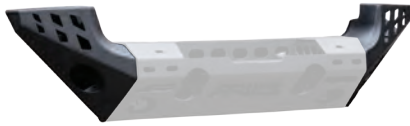

15600-1 & AL15600-1



C15600-1 & ALC15600-1



25600-1 & AL25600-1

Modular Bumper Replacement Side Extensions and Side Caps

| Part# | Material | Side Extension Finish | Side Cap Finish |
|---------------------|----------|-----------------------|-----------------|
| Front Bumper | | | |
| 15600-1 | Steel | Textured black | -- |
| C15600-1 | Steel | -- | Textured black |
| AL15600-1 | Aluminum | Textured black | -- |
| ALC15600-1 | Aluminum | -- | Textured black |
| RA15600-1* | Aluminum | Raw aluminum | -- |
| RAC15600-1* | Aluminum | -- | Raw aluminum |
| Rear Bumper | | | |
| 25600-1 | Steel | Textured black | -- |
| AL25600-1 | Aluminum | Textured black | -- |
| RA25600-1* | Aluminum | Raw aluminum | -- |

* Raw aluminum (available by special order)

/ Center sections



15600-0 & AL15600-0



AL15600-0-3



25600-0 & AL25600-0



AL25600-0-3

Modular Bumper Replacement Center Sections

| Part# | Material | Finish |
|---------------------|----------|--------------------|
| Front Bumper | | |
| 15600-0 | Steel | Textured black |
| AL15600-0 | Aluminum | Textured black |
| AL15600-0-3 | Aluminum | Silver powder coat |
| RA15600-0* | Aluminum | Raw aluminum |
| Rear Bumper | | |
| 25600-0 | Steel | Textured black |
| AL25600-0 | Aluminum | Textured black |
| AL25600-0-3 | Aluminum | Silver powder coat |
| RA25600-0* | Aluminum | Raw aluminum |

* Raw aluminum (available by special order)

JEEP® MODULAR BUMPER ACCESSORIES

NEW Winch fairlead mount



15600FB

- Easily and securely mounts on ARIES modular bumper winch housing
- Two holes, spaced 10" center-to-center, accept most types of fairleads
- See page 67 for more information

Tow hook



15600TW

- Perfect for recovery towing applications
- Up to 9,000 lbs. capacity
- Fits both steel and aluminum modular bumpers (aluminum requires winch receiver plate bracket)
- See page 67 for more information

Winch receiver plate bracket

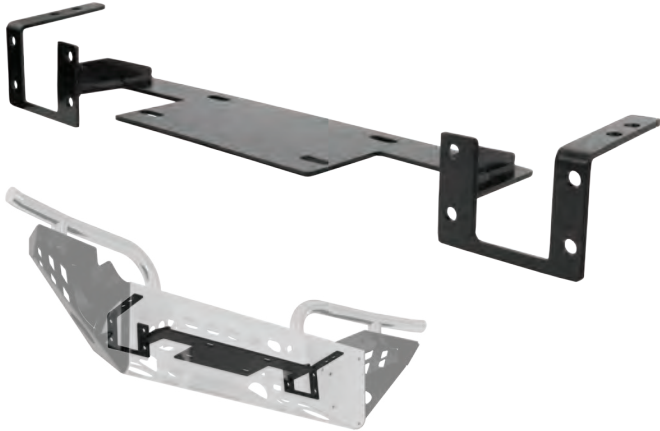

15600WRB

- Required to reinforce an aluminum front modular bumper when using a winch or tow hooks
- See page 67 for more information

License plate bracket



55-0000

- Provides a solid mounting location to keep license plate visible
- See page 68 for more information



ARIES

JEEP® ROCKER STEPS

NEW

for added protection and a solid foothold on any off-roader

/ Wide, flat profile

Unlike side bars that have low ground clearance, rocker steps are set high enough to clear brush, boulders and other off-road debris

/ Reliable footing

While most rocker bars only serve to protect, the welded top plate provides a convenient, comfortable, 3" wide step up into the Jeep®

/ Off-road ready

The all-steel construction, double-tube layout and tough, textured black powder coat finish offer the durability needed to conquer the trail

Features and benefits

- Double-tube layout and 3" wide top plate provide a solid step
- Heavy-duty design offers extra protection for the sides of the Jeep®
- Flat profile increases ground clearance for ready off-roading
- Textured black powder coat easily hides scratches and dirt
- All-steel construction for reliable strength
- Pre-welded mounting brackets increase rigidity and simplify installation
- No-drill, vehicle-specific application for a custom fit
- Sold in pairs with mounting hardware included
- Three-year warranty

Material and finish option

Rocker steps



Material:
Carbon steel

Finish:
Textured black powder coat

Applications

| Rocker Steps | | | |
|---------------------|--------------|--------------|--------------|
| Model | Style | Years | Part# |
| Wrangler | 2-door | 07 - 16 | 2074100 |
| | 4-door | 07 - 16 | 2074101 |



2074101



2074101



JEEP® TUBE DOORS

for a taste of freedom with every drive

/ Off-road ready

The open design, aggressive cutout pattern and lightweight aluminum construction are geared for the ultimate off-roading experience

/ Solid construction

Hardened T6 aluminum provides high structural integrity, while the tungsten insert gas (TIG) welds allow for clean weld lines and a precise fit

/ Strong finish

The textured black powder coat finish resists UV damage and easily hides scratches and dirt to stand up to the off-road elements

Features and benefits

- Open design and aggressive cutout for the ultimate off-roading experience
- Hardened T6 aluminum construction to be lightweight and rust-free
- Textured black powder coat easily hides scratches and dirt
- 100% TIG welds for a precise fit
- Simple installation using existing hinge points
- Accepts factory mirrors (not compatible with power mirrors)
- Sold in pairs with swing-out straps included
- Five-year warranty



AR15009
front door

Material and finish option

Tube doors

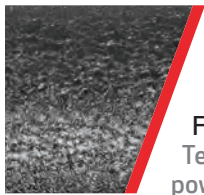

Material:
T6 aluminum alloy

Finish:
Textured black powder coat



25009
rear door

Applications

| Tube Doors | | | |
|------------|---------|----------|---------|
| Model | Years | Location | Black# |
| Wrangler | 07 - 16 | Front | AR15009 |
| | 07 - 16 | Rear | 25009 |

Tube doors may be illegal in some states. Check with the local and state laws before installing.



KEY-OPERATED LOCKING LATCH



While ARIES tube doors are built to open up the Jeep® Wrangler for ultimate off-roading, they are also designed to be functional and maintain a certain level of vehicle security. The doors operate using the factory hinges and

existing striker plates, and they feature a locking latch mechanism to help deter unwelcomed access into the Jeep® while it is parked and left unattended.

JEEP® FENDER FLARES

give those off-road tires the recognition they deserve

/ Lightweight aluminum build

Aluminum construction allows the flares to be strong and lightweight, while the durable, textured black finish easily hides scratches and dirt

/ Custom fit

The 4" width and vehicle-specific contours offer a precise fit for the Jeep® Wrangler, adding style, utility and accommodating the off-road ride

/ Solid installation

The flares bolt directly onto the body, replacing the factory flares, and they can accept LED side markers for maximum safety on and off the road

Features and benefits

- Hardened T6 aluminum construction to be lightweight and rust-free
- Textured black powder coat easily hides scratches and dirt (also available in a raw, paintable finish)
- 4" wide design with vehicle-specific contours
- Solid, bolt-on installation
- Accepts LED fender flare side markers ARIES #1500240 (some drilling required)
- Available for front and rear wheels
- Sold in pairs, including passenger and driver side
- Mounting hardware included (some drilling may be required)
- Three-year warranty



1500201



2500201

Material and finish options

Fender flares

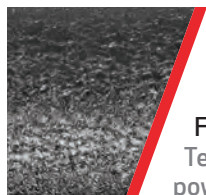

Material:
T6 aluminum alloy
Finish:
Textured black powder coat



Material:
T6 aluminum alloy
Special order finish:
Raw aluminum

Applications

| Fender Flares | | | | |
|---------------|----------|---------|---------|---------|
| Model | Location | Years | Black# | Raw# |
| Wrangler | Front | 07 - 16 | 1500201 | 1500202 |
| | Rear | 07 - 16 | 2500201 | 2500202 |



NEW FENDER FLARE SIDE MARKERS

- LED components for a bright, long-lasting light
- Splices into existing factory wiring harness
- Wires route through fender frame to keep them well protected
- DOT-approved for safety
- Includes all necessary installation hardware
- One-year warranty



JEEP® SECURITY CARGO LID

for ultimate off-road security and storage

/ Integrated security

The six-panel enclosure bolts directly into the bed of the Jeep® and creates a spacious, key-operated storage area that works with the rear door

/ Versatile design

Tie-down anchors and a weight capacity of 75 lbs. allow items to be stored on top, and the lid can be flipped and converted into a usable surface

/ Lightweight aluminum build

The hardened T6 aluminum construction is strong, rust-free and lightweight to keep valuables safe and protect them from the elements

Features and benefits

- Six-panel, bolt-on design integrates with the layout of the Jeep® (4-door models only)
- Key-operated, water-resistant enclosure provides a generous storage area
- Hardened T6 aluminum construction to be lightweight and rust-free
- Textured black powder coat easily hides scratches and dirt
- Works in conjunction with the rear door
- Convertible to a workbench or table area
- 1/2" diameter tie-down anchors on top for securing additional cargo
- Weight capacity up to 75 lbs.
- Compatible with hardtop on or off, soft top and subwoofer
- Complete kit part number ships in two boxes
- Three-year warranty



Material and finish option

Cargo lid

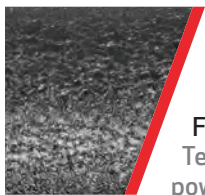

Material:
T6 aluminum alloy

Finish:
Textured black powder coat

Applications

| Security Cargo Lid | | | | |
|--------------------|---------|---------------|-------------|-------------|
| Model | Years | Complete Kit# | Component 1 | Component 2 |
| Wrangler Unlimited | 07 - 10 | 2070465 | ALC25000-01 | ALC25000-00 |
| | 11 - 16 | 2070475 | ALC25001-01 | ALC25000-00 |



KEY-OPERATED LOCKING LATCH



The ARIES security cargo lid not only works with the rear door of the Jeep®, but it also functions independently, meaning it can be opened without requiring the rear door to be opened first. It features a key-operated, quarter-turn latch for quick, convenient access to the cargo area.

Simply insert the key, turn the latch and lift the lid. The locking latch mechanism is made with durable metal components and is covered in a chrome finish for lasting rust resistance.

JEEP® TUBE BUMPERS

for a classic look that never goes out of style

/ Solid construction

3" diameter tubing is welded together in a double-stacked design for increased strength and a classic appearance

/ Strong finish

Both the polished stainless and black powder coat finishes are highly resistant to rust, scratches and other damage

/ Simple installation

Bumper installs using the vehicle's original factory bumper mounting points for quick, secure, attachment

Features and benefits

- Double-stacked layout for a classic appearance
- 3" diameter, heavy-wall tube design
- Front bumper features protective welded brush guard
- Cutout on rear bumper allows for spare tire
- Uses pre-existing factory mounting points for easy installation
- Front and rear bumpers available
- Three-year warranty

Material and finish options

Tube bumper

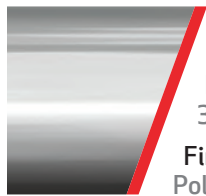

Material:
304 stainless steel
Finish:
Polished stainless

Tube bumper

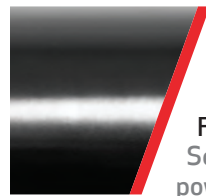

Material:
Carbon steel
Finish:
Semi-gloss black powder coat



15200
front bumper



25201
rear bumper

Applications

| Tube Bumpers | | | |
|--------------------------|---------|--------|------------|
| Model / Location | Years | Black# | Stainless# |
| CJ, YJ, Wrangler - Front | 76 - 06 | 15200 | 15200-2 |
| CJ, YJ, Wrangler - Rear | 76 - 06 | 25201 | 25201-2 |



LICENSE PLATE BRACKET



55-0000

- Easily bolts onto any ARIES tube bumper
- Provides a solid mounting location to keep license plate visible
- Steel construction with black powder coat finish
- Includes two license plate mounting bolts

REMOVABLE UNIVERSAL MUD FLAPS

easily attached or detached with the pull of a pin

/ Use as needed

The mounting bracket features a quick-release pull-pin to allow the mud flaps to be attached or detached whenever necessary

/ Universal design

The 22" hanger can be cut to virtually any length needed to perfectly match the unique tire offset of each truck, Jeep® or SUV

/ Solid construction

The hangers and mounting brackets are made from high-strength steel and have a durable powder coat finish to withstand corrosion

Features and benefits

- Quick-release, pull-pin removal system for a use-as-needed design
- No drilling required on Jeep® Wrangler JK
- Universal brackets with multiple mounting holes fit a variety of vehicles
- 22" hanger can be cut to match different tire offsets
- Thick rubber flaps withstand heavy abrasions and shed water with ease
- High-strength steel brackets with durable powder coat finish
- Sold in pairs with installation hardware included
- One-year warranty

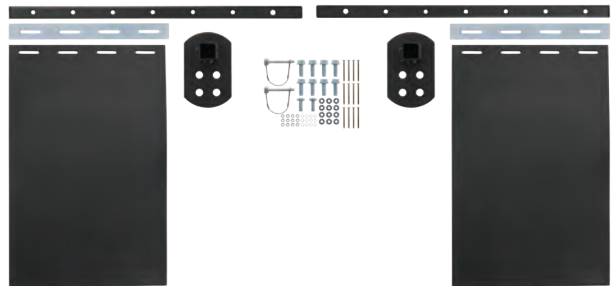

AR111900

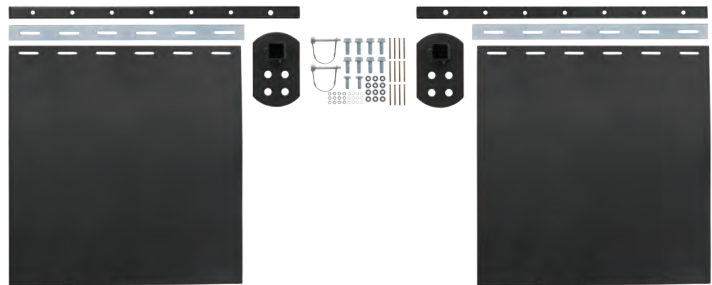

AR111950

Material and finish option

Mud flaps

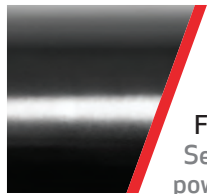

Material:
Carbon steel

Finish:
Semi-gloss black
powder coat

Applications

| Removable Universal Mud Flaps | |
|--------------------------------------|--------------|
| Size | Part# |
| 12" x 18" | AR111900 |
| 18" x 18" | AR111950 |



MADE FOR VERSATILITY

The two key advantages of ARIES mud flaps are that they're removable and universal. The adjustable brackets mount on the vehicle, using four bolts. They can be positioned horizontally or vertically.

The quick-release pull-pin then allows the flaps to be attached to the brackets in mere seconds, and detached whenever necessary.

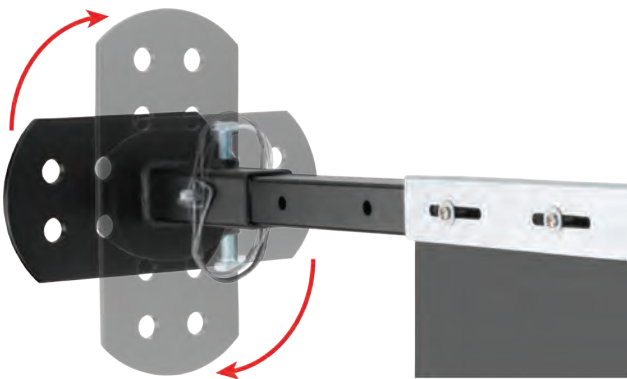

JEEP® ACCESSORIES

go from roadworthy to trail-ready

When it comes to Jeep® accessories, ARIES gets revved up about charging off road. Our products reflect our passion because we know that it is the same passion that drives your customers.

With everything from our bumper tow hooks to our Jeep® roof light bar, we offer the variety you expect and the quality your customers demand.

Accessories parts list

| Jeep® Accessories | | |
|-------------------|-------------------------------|-------|
| Part# | Description | Page# |
| AR111900 | Removable universal mud flaps | 68 |
| AR15800 | Windshield light brackets | 69 |
| 15600WRB | Winch receiver plate bracket | 67 |
| 15600TW | Tow hook | 67 |
| 1500240 | Fender flare side marker | 68 |
| 15600FB | Winch fairlead mount | 67 |

| Jeep® Accessories | | |
|-------------------|---|-------|
| Part# | Description | Page# |
| 15910 | Roof light bar | 66 |
| 25630AB | Tire relocation carrier and reinforcement brackets | 69 |
| 55-0000 | License plate relocation bracket for Jeep® modular and tube bumpers | 68 |
| 256TBL | Third brake light extension bracket | 69 |

ROOF LIGHT BAR

- Accommodates most LED light bar sizes and round lights up to 9" in diameter
- Designed to contour to the windshield
- Fits 2007 - 2016 Jeep® Wrangler JK
- Hardened T6 aluminum construction to be lightweight and rust-free
- Textured black powder coat easily hides scratches and dirt
- Will not whistle like competitive models
- Compatible with hardtops and soft tops
- Three-year warranty



15910



NEW WINCH FAIRLEAD MOUNT

- Easily and securely mounts on ARIES modular bumper winch housing
- Two holes, spaced 10" center-to-center, accept most types of fairleads
- Solid, 1/4" thick steel construction
- Durable carbide black powder coat finish
- Fits both steel and aluminum modular bumpers (aluminum requires winch receiver plate bracket)
- Uses winch and fairlead mounting hardware

15600FB

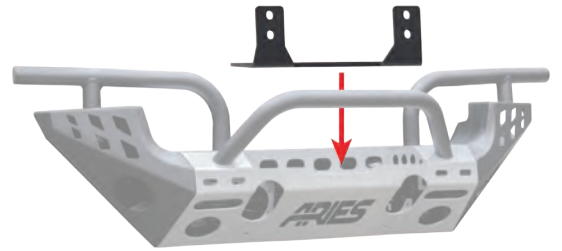

WINCH RECEIVER PLATE BRACKET

- Required to reinforce an aluminum front modular bumper when using a winch or tow hooks
- Solid, 1/4" thick carbon steel construction
- Durable black powder coat finish
- Includes mounting hardware



15600WRB

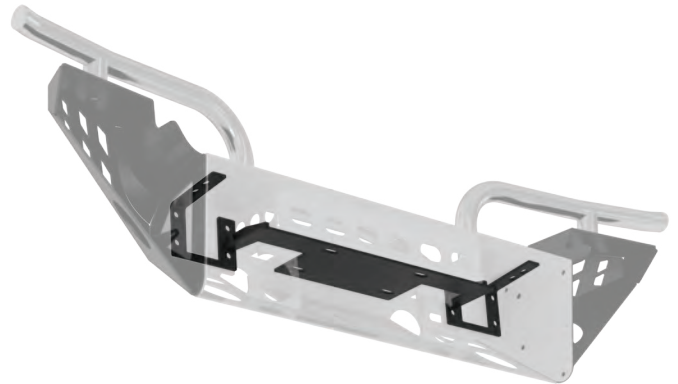

TOW HOOK

- Perfect for recovery towing applications
- Up to 9,000 lbs. capacity
- Fits both steel and aluminum modular bumpers (aluminum requires winch receiver plate bracket)
- Utilizes existing factory bolts on YJ and TJ models
- Steel construction with black powder coat finish
- Three-year warranty



15600TW

NEW FENDER FLARE SIDE MARKERS

- LED components for a bright, long-lasting light
- Splices into existing factory wiring harness
- Wires route through fender frame to keep them well protected
- DOT-approved for safety
- Includes all necessary installation hardware
- One-year warranty



REMOVABLE UNIVERSAL MUD FLAPS

- Quick-release, pull-pin removal system for a use-as-needed design
- No drilling required on Jeep® Wrangler JK
- Universal brackets with multiple mounting holes fit a variety of vehicles
- 22" hanger can be cut to match different tire offsets
- One-year warranty

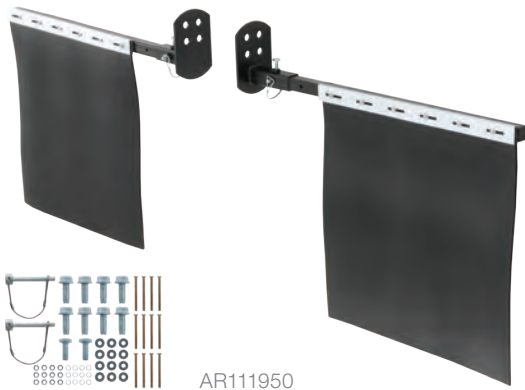

AR111950

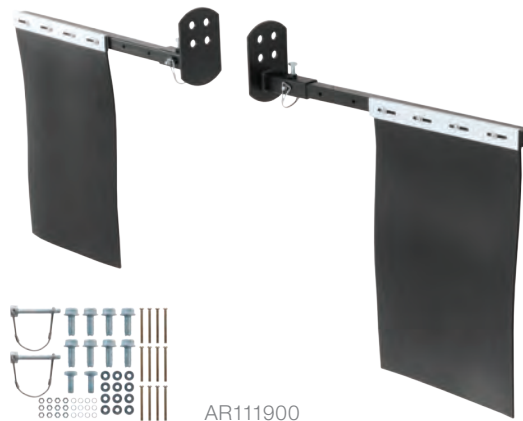

AR111900

LICENSE PLATE RELOCATION BRACKETS

- Easily bolts onto any ARIES® tube bumper or modular bumper
- Provides a solid mounting location to keep license plate visible
- Steel construction with black powder coat finish
- Includes two license plate mounting bolts



55-0000

TIRE RELOCATION CARRIER & REINFORCEMENT BRACKETS

- Allows for a larger spare tire up to 35" in diameter
- Fits 2007 - 2016 Jeep® Wrangler JK
- Securely bolts onto existing tire carrier
- Maintains easy access to the rear cargo area
- Steel construction with black powder coat finish
- Includes installation hardware

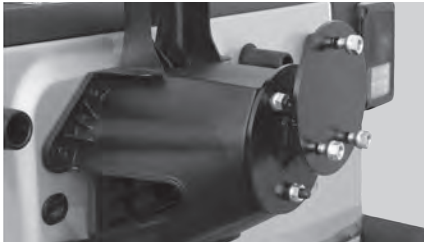

25630AB

WINDSHIELD LIGHT BRACKETS

- Accepts off-road lights, fog lights, driving lights and more
- Securely bolts on at the windshield hinge
- Easy, no-drill installation
- Durable black powder coat finish
- Includes driver-side and passenger-side brackets



AR15800

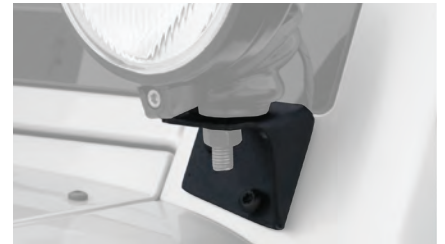

THIRD BRAKE LIGHT EXTENSION BRACKET

- Allows brake light to be seen over a spare tire up to 35" in diameter
- Improves safety on and off the road
- Compatible with tire relocation carrier
- Steel construction with black powder coat finish
- Includes installation hardware (some cutting required)

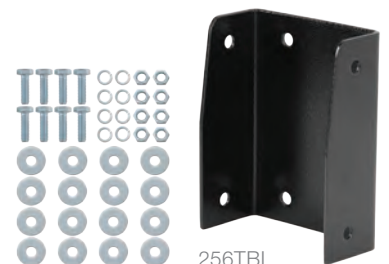

256TBL

INTERIOR PROTECTION





WORK HARD TO PLAY EVEN HARDER

ARIES is aimed at complete protection of your customer's vehicle interior – not just for the floor but for every row and every seat. We offer Seat Defender™ and StyleGuard™ floor liners for interior protection unlike any other.

Seat Defender™ is an innovative, universal and use-as-needed seat protection system that stops damage before it happens, instead of just covering it up. It is easy to install, remove, clean and store.

StyleGuard™ floor liners feature a triple-layer defense, a custom-molded fit and a refined appearance. They break away from the industrial look and offer superior slip resistance using patented OmniGrip™ fibers.



Complete vehicle coverage

Instead of only protecting the vehicle's floor, StyleGuard™ and Seat Defender™ work together to offer a complete, waterproof protection system



Multiple applications

Seat Defender™ comes in two universal sizes, while StyleGuard™ liners are available for a variety of Jeeps® for individual rows or in complete kits



Durable construction

Seat Defender™ is made with a tough, dual-sided construction, and StyleGuard™ features a triple-layer design with industrial-strength materials

CATEGORY INDEX

72 | **Seat Defender™**

74 | **StyleGuard™ Floor Liners**

SEAT DEFENDER™

with a universal, dual-sided design to protect any seat

/ As-needed protection

The fast, simple design allows it to be used as needed to stop damage instead of just covering it up. It then removes and cleans quickly to be ready for use again

/ Dual-action defense

The bottom layer of thermoplastic rubber grips the seat, while the top layer of 600-denier terylene fabric defends against spills, dirt, pet dander and more

/ Universal design

Seat Defender™ is available in two universal sizes and four different color options. It easily installs on front or rear seats and fits virtually any bucket or bench seat

Features and benefits

- Use-as-needed, universal design with dual-layer, non-skid protection
- Fast and easy to remove, clean and store
- Thermoplastic rubber grips the seat, providing added comfort and safety
- Woven 600-denier terylene fabric blocks spills, dirt and more
- 100% waterproof and machine washable
- Allows for side airbag deployment
- Maintains seat belt access on both bucket and bench seats (may interfere with center shoulder strap)
- Bucket and bench size options fit virtually all vehicles



Color options

Seat Defender™

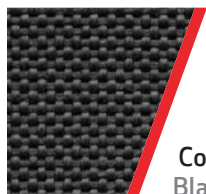

Color:
Black

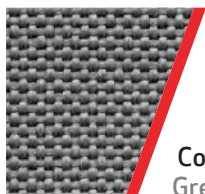

Color:
Grey



Color:
Brown

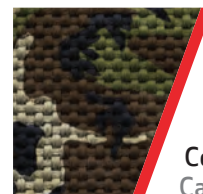

Color:
Camo

Applications

| Seat Defender™ | | | | |
|----------------|---------|---------|---------|---------|
| Location | Black# | Grey# | Brown# | Camo# |
| Bucket | 3142-09 | 3142-01 | 3142-18 | 3142-20 |
| Bench | 3146-09 | 3146-01 | 3146-18 | 3146-20 |



TWO LAYERS OF PROTECTION

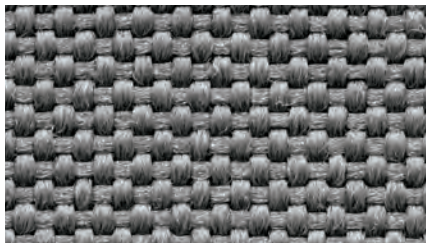

/ 600D terylene fabric

The top side of the Seat Defender™ is a durable, woven, 600-denier terylene fabric that keeps dirt and spills out and cleans up easily

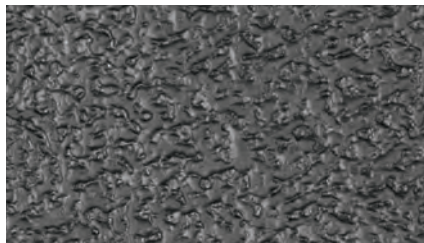

/ Thermoplastic rubber (TPR)

The underside is a layer of waterproof thermoplastic rubber that not only protects against spills but also grips the seat for added safety

STYLEGUARD™ FLOOR LINERS

with patented OmniGrip™ fibers

/ Triple-layer defense

Made with a unique, three-layer construction of thermoplastic rubber, XPE foam and OmniGrip™ fibers, StyleGuard™ provides ultimate interior protection

/ Custom-molded fit

Each StyleGuard™ liner is laser-measured and custom-molded for a specific make and model, allowing it to fit in a way that no universal floor mat can

/ Refined appearance

Unlike the industrial, utilitarian look of other liners, StyleGuard™ uses a vehicle-specific contour and textured surface to offer a fresh, refined appearance

Features and benefits

- Durable, textured surface for a refined appearance and ultimate interior protection
- Triple-layer construction using industrial-strength materials
- Thousands of patented OmniGrip™ fibers resist slipping on all types of carpet
- Laser-measured for perfect, vehicle-specific contour
- Flexible, breathable rubber will not become brittle over time
- Raised edges contain all liquids and debris
- Resists moisture and reduces engine and road noise
- Simple, instantaneous installation; no extra grip discs required
- Offered in complete kits or individually for the first row, second row or cargo area
- For application guide, see page 78 or ariesautomotive.com
- Limited lifetime warranty



JP0031309

Color options

StyleGuard™ floor liners

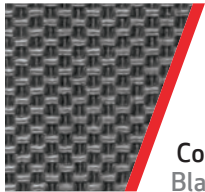

Color:
Black



Color:
Grey



Color:
Beige



THREE LAYERS OF INNOVATION



/ Thermoplastic rubber (TPR)

The top layer of finely textured TPR is strong, durable, wear-resistant and waterproof to stand up to scuffs, dings, spills, drips and more

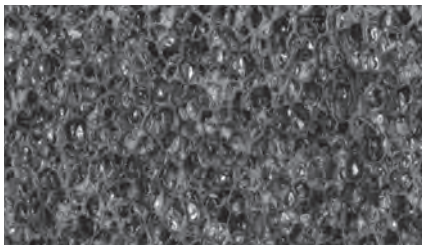

/ Layered XPE foam

The middle layers of semi-rigid cross-linked polyethylene foam are waterproof, shock-absorbent, sound-insulating and thermostatic for a more comfortable ride



/ OmniGrip™ fibers

Instead of two points of contact, the bottom layer of OmniGrip™ fibers has thousands. The fibers grip all carpet, preventing shift and providing safety

Thermoplastic Rubber

Layered XPE Foam

OmniGrip™ Fibers

Vehicle Carpet

VEHICLE-SPECIFIC FROM FRONT TO REAR

Instead of only providing your customers with a few universal floor mat options – none of which fits their vehicle quite right – we design each StyleGuard™ floor liner to have a unique shape that contours to the vehicle's floor. This is done using laser-measure technology and semi-rigid, moldable materials like thermoplastic rubber and XPE foam.

We apply this same vehicle-specific concept across the entire vehicle, meaning StyleGuard™ floor liners are not just for the driver's seat. They are available individually for the first row and second row, as well as the cargo area on certain applications.



PROTECTING THE CARGO AREA

While protecting each row of your customer's Jeep® is important, we know that the cargo area takes just as much of a beating. StyleGuard™ cargo floor liners feature the same three-layer, custom-fit protection as our floor liners, transforming the cargo area into a waterproof, wear-resistant,

thermostatic and shock-absorbent space. StyleGuard™ cargo liners are perfect for outdoor enthusiasts, industrial and commercial workers, do-it-yourselfers and more. Many models feature a folding design for compact storage, and all are backed with a limited lifetime warranty.



APPLICATION GUIDE

ARIES StyleGuard™ floor liners are available for several different Jeep® models, and each liner features a vehicle-specific design for a custom fit. Use the following application guide to find the right fit for your customers. Stay up-to-date with the latest applications by visiting our website at ariesautomotive.com/appguides.

StyleGuard™ floor liners are available individually for the first row and second row, as well as the cargo area for certain applications. We also offer complete vehicle kits that include first and second row floor liners for particular vehicles in one complete package (kits are only available in black, unless otherwise noted). See page 79 for applications.

| StyleGuard™ Floor Liners | | | | | | | |
|--------------------------|-------------------|---------|----------|------------|------------|------------|--|
| Make / Model | Style / Notes | Years | Location | Black# | Grey# | Beige# | |
| Jeep | | | | | | | |
| Cherokee | All | 14 - 16 | Row 1 | JP01011509 | JP01011501 | JP01011502 | |
| Cherokee | All | 14 - 16 | Row 2 | JP01021509 | JP01021501 | JP01021502 | |
| Commander | All | 06 - 10 | Row 2 | JP00021509 | JP00021501 | JP00021502 | |
| Compass | All | 14 - 15 | Row 1 | JP00611509 | JP00611501 | JP00611502 | |
| Compass | All | 07 - 13 | Row 1 | JP00211509 | JP00211501 | JP00211502 | |
| Compass | All | 07 - 15 | Row 2 | JP00221509 | JP00221501 | JP00221502 | |
| Compass | All | 07 - 15 | Cargo | JP0021309 | JP0021301 | -- | |
| Grand Cherokee | All | 05 - 10 | Row 1 | JP00111509 | JP00111501 | JP00111502 | |
| Grand Cherokee | All | 05 - 10 | Row 2 | JP00121509 | JP00121501 | JP00121502 | |
| Grand Cherokee | All | 05 - 10 | Cargo | JP0011309 | JP0011301 | JP0011302 | |
| Grand Cherokee | All | 11 - 12 | Row 1 | JP00411509 | JP00411501 | JP00411502 | |
| Grand Cherokee | All | 11 - 15 | Row 2 | JP00421509 | JP00421501 | JP00421502 | |
| Grand Cherokee | All | 11 - 15 | Cargo | JP0041309 | JP0041301 | JP0041302 | |
| Grand Cherokee | All | 13 - 15 | Row 1 | JP00511509 | JP00511501 | JP00511502 | |
| Wrangler | 2-door | 14 - 15 | Row 1 | JP01111509 | JP01111501 | JP01111502 | |
| Wrangler | 2-door | 14 - 15 | Row 2 | JP01221509 | -- | -- | |
| Wrangler Unlimited | 4-door | 07 - 13 | Row 1 | JP00311509 | JP00311501 | JP00311502 | |
| Wrangler Unlimited | 4-door | 14 - 15 | Row 1 | JP01111509 | JP01111501 | JP01111502 | |
| Wrangler Unlimited | 4-door | 07 - 13 | Row 2 | JP00321509 | JP00321501 | JP00321502 | |
| Wrangler Unlimited | 4-door | 14 - 15 | Row 2 | JP01121509 | JP01121501 | JP01121502 | |
| Wrangler Unlimited | 4-door | 07 - 14 | Cargo | JP0031309 | JP0031301 | JP0031302 | |
| Wrangler Unlimited | Without subwoofer | 2015 | Cargo | JP0031309 | JP0031301 | JP0031302 | |
| Renegade | All | 2015 | Row 1 | JP01311509 | -- | -- | |
| Renegade | All | 2015 | Row 2 | JP01321509 | -- | -- | |
| Renegade | All | 2015 | Cargo | JP0131309 | -- | -- | |



COMPLETE KIT APPLICATION GUIDE

Complete vehicle kits include first and second row floor liners for particular vehicles in one complete package (kits are only available in black, unless otherwise noted).

| StyleGuard™ Floor Liner Kits | | | | | | | |
|------------------------------|-------------------|---------|-------|---------|------------|------------|--|
| Make / Model | Style / Notes | Years | Color | Kit# | Row 1# | Row 2# | |
| Jeep | | | | | | | |
| Cherokee | -- | 14 - 16 | Black | 2945009 | JP01011509 | JP01021509 | |
| Grand Cherokee | -- | 13 - 15 | Black | 2919209 | JP00511509 | JP00421509 | |
| Wrangler | 2-door | 14 - 15 | Black | 2945109 | JP01111509 | JP01221509 | |
| | 4-door, Unlimited | 14 - 15 | Black | 2945209 | JP01111509 | JP01121509 | |
| | 4-door, Unlimited | 07 - 13 | Black | 2945309 | JP00311509 | JP00321509 | |

MARKETING MATERIALS





SHOW THEM THE ARIES DIFFERENCE

At ARIES, we believe that creating a successful business means more than designing and delivering an innovative product line. We believe that supporting our customers is just as important.

Our marketing materials include brochures, signage, displays, crops and more to give you the tools you need to successfully market and sell ARIES products. With our recent rebranding, these materials feature our new logo and style and offer a professional look for the aftermarket dealer.

For both in-store and online use, we also offer extensive image, video and written content resources to inform your customers and increase sales. These assets are available to all ARIES dealers, free of charge. More information is available in the Dealer Portal Media Kit at ariesautomotive.com.



Detailed literature

Our catalogs and brochures present our products with high-res, professional photography and offer detailed information about our products, highlighting our unique selling points



Informative signage

With everything from banners and display boards to header cards and countertop signs, our signage features full-color images and graphics to draw in and educate your customers



Attractive displays

We offer crops and minis for a variety of our products, as well as retail-friendly wall displays and display stands to show off ARIES products, in the best light, to your customers

CATEGORY INDEX

82 | **Catalog and Literature**

83 | **Display Boards**

83 | **Promotional Banner**

84 | **Side Bar Crops**

84 | **Vinyl Logo Decals**

85 | **StyleGuard™ Minis**

85 | **Countertop Display**

86 | **Wall Displays**

87 | **Display Stands**

PRODUCT CATALOGS

- Complete listings of ARIES products and applications
- Downloadable versions available at ariesautomotive.com



9900007



9900008

Product Catalogs

| Part# | Description |
|---------|--|
| 9900007 | 2016 interior catalog and application guide |
| 9900008 | 2016 exterior catalog and application guides |

PRODUCT LITERATURE

- Highlights key features of specific products for improved business-to-business sales



9900011



9900054



9900055

Product Literature

| Part# | Description |
|---------|---------------------------|
| 9900011 | StyleGuard™ floor liners |
| 9900054 | AeroTread™ running boards |
| 9900055 | Jeep® rocker steps |

DISPLAY BOARDS

- Show off ARIES product offerings in your store
- Constructed of rigid styrene board



JEEP® PRODUCTS



9900058



STYLEGUARD™ FLOOR LINERS



9900059



RIDGESTEP™ & AEROTREAD™ RUNNING BOARDS



9900060

Display Boards

| Part# | Description | Dimensions |
|---------|--|---------------|
| 9900058 | Jeep® products | 23 1/2" x 18" |
| 9900059 | StyleGuard™ floor liners | 23 1/2" x 18" |
| 9900060 | AeroTread™ and RidgeStep™ running boards | 23 1/2" x 18" |

PROMOTIONAL BANNER

- Show off ARIES brand name to draw in traffic



9900056

Promotional Banner

| Part# | Description | Dimensions |
|---------|-------------------|------------|
| 9900056 | ARIES logo banner | 5' x 2' |

SIDE BAR & RUNNING BOARD CROPS

- Fits on ARIES display stands WDP0002, 9910001 and 9910115
- Allows customers to handle and experience products with ease



| Side Bar & Running Board Crops | |
|--------------------------------|--------------------|
| Part# | Description |
| 9910102 | 4" oval, black |
| 9910103 | 4" oval, stainless |
| 9910104 | 4" round, black |

| Side Bar & Running Board Crops | |
|--------------------------------|-----------------------|
| Part# | Description |
| 9910109 | AeroTread™, black |
| 9910110 | AeroTread™, stainless |
| 9910113 | Jeep® rocker step |

VINYL LOGO DECALS

- Accessory stickers to promote ARIES brand awareness
- Great for customer give-aways and to stick on vehicles



| Vinyl Logo Decals | | |
|-------------------|-------------------------|------------|
| Part# | Description | Dimensions |
| 9900049 | Vinyl logo decal, red | 5" x 1" |
| 9900050 | Vinyl logo decal, white | 5" x 1" |

STYLEGUARD™ FLOOR LINER MINIS

- Fits on ARIES display stand 3505-A, see page 87
- Great for ARIES countertop display 9900061, see below
- Allows customers to handle and experience products with ease



DP60-001



DP60-002



DP60-009

StyleGuard™ Floor Liner Minis

| Part# | Description |
|----------|-------------------------------------|
| DP60-001 | StyleGuard™ floor liner mini, grey |
| DP60-002 | StyleGuard™ floor liner mini, beige |
| DP60-009 | StyleGuard™ floor liner mini, black |



3505-A

STYLEGUARD™ COUNTER DISPLAY

- Attractive countertop display to help your staff promote ARIES StyleGuard™ floor liners



9900061

StyleGuard™ Counter Display

| Part# | Description |
|---------|--|
| 9900061 | StyleGuard™ floor liner countertop display |

WALL DISPLAYS

- Educates customers and allows for hands-on experience
- Convenient, wall-mounted design utilizes wall space
- Product not included with the display stand



WDP0001



WDP0002



9910115

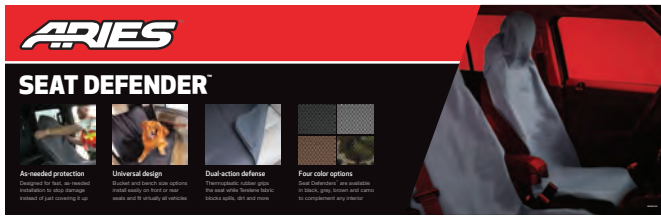

9900040

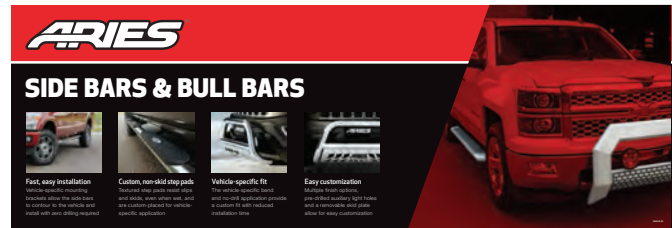

9900042



9900041 Side A



9900041 Side B

Wall Displays and Header Cards

| Part# | Description | Dimensions |
|---------|--|--------------|
| WDP0001 | Seat Defender™, holds up to eight | -- |
| 9900040 | Seat Defender™ header card for WDP0001 display | 22" x 7" |
| WDP0002 | Side bar and bull bar display, holds one each | -- |
| 9900042 | Side bar and bull bar header card for WDP0002 display | 22" x 7 1/2" |
| 9910115 | Slat board display, holds one side bar or one bull bar | -- |
| 9900041 | Reversible side bar and bull bar header card for 9910115 display | 12" x 6" |

DISPLAY STANDS

- Educates customers and allows for hands-on experience
- Free-standing displays can easily be set up anywhere in your store



9910000



9910001



3505-A

JEEP® MODULAR BUMPERS

with a mix-and-match design for ultimate customization

- Customizable configuration**
With up to 16 different configurations for the front and three for the rear, the modular design allows pieces to be added or deleted, making it easy to find the right look and change it any time.
- Available in aluminum or steel**
ARIES bumpers are available in aluminum or steel, with various finish options. Our aluminum bumpers are constructed with hardened 70 aluminum alloy to be strong, lightweight and rust-free.
- Multiple accessory options**
With mounting tabs and cutouts for LED lights, pre-drilled holes for mounting tow hooks, and a 20" x 7" x 3/4" housing to accept most types of winches, adding accessories is easy.

9900038

SIDE BARS

step up and stand out

- AdvantEDGE™ Series**
AdvantEDGE™ side bars have an all-aluminum construction to be lightweight and rust-free, and they feature a unique, eight-sided tube profile to complement the style of today's trucks.
- More applications**
ARIES side bars come in various tube diameters, from 2" up to 3". We offer hundreds of applications, and each of our side bars includes unique vehicle-specific brackets for a custom fit.
- Variety of finishes**
With material options like aluminum, stainless and carbon steel, and finishes like textured black, semi-gloss black and polished stainless, you can choose the side bar that best suits your ride.

9900039

STYLEGUARD™ FLOOR LINERS

- Triple-layer construction**
Three different materials combine to offer ultimate interior protection.
- OmniGrip™ fibers**
Resilient fibers provide superior floor suction in all types of roads to resist slipping.
- Custom-molded fit**
Each liner is laser measured to perfectly contour to fit vehicle-specific applications.
- Refined, textured surface**
The advanced, textured, custom-molded design catches dirt and other unwanted road debris.

9900043

Display Stands and Header Cards

| Part# | Description | Dimensions |
|---------|---|-------------------|
| 9910000 | Jeep modular bumper display stand, holds one front and one rear bumper (bumpers and header car not included) | -- |
| 9900038 | Jeep modular bumper display stand header card for 9910000 | 42 1/8" x 13 3/8" |
| 9910001 | Side bar display stand, holds five crops (crops and header car not included) | -- |
| 9900039 | Side bar display stand header card for 991001 | 42 1/8" x 13 3/8" |
| 3505-A | StyleGuard™ display stand tree (includes DP60-001, DP60-002 and DP60-009 floor liner minis and 9900043 header card) | -- |
| 9900043 | Replacement StyleGuard™ display stand header card, two-sided | 22" x 7" |



WARRANTY INFORMATION

ARIES Automotive (ARIES) warrants to the original purchaser (Purchaser) its products to be free from defect under normal use and service, ordinary wear and tear excepted, for the warranty period stated below, from the date of the original retail purchase, but subject to the limitations as set forth below.

Limitations on warranty

ARIES's obligation under the above warranty is limited to repair or replacement of the ARIES product (Product) at its option due to a manufacturing defect of the Product. ARIES shall not be liable for the loss of or use of vehicles; loss of or damage to personal property; expenses such as telephone, lodging, gasoline, towing, tire damage or any other incidental or consequential damages incurred by the Purchaser or any other person or entity.

ARIES will examine the returned Product. If ARIES, in its exclusive discretion, determines that the defect or damaged Product is covered under this limited warranty, ARIES will repair the Product or replace it at that time.

Alterations to or misuse of the Product will void the warranty. Failure to properly maintain and regularly inspect the Product according to the specific instruction sheet accompanying each Product shall also void the warranty.

Some states do not allow the exclusion or limitation of incidental or consequential damages. If such exclusions or limitations are prohibited under applicable law, the above limitations or exclusions may not apply.

This warranty gives you specific legal rights, and you may also have other rights, which vary from state to state.

The Purchaser, when returning an ARIES Product, must observe the following steps:

1. The Purchaser must have proof of purchase of any damaged Product and supply the same to the headquarters of ARIES. The Purchaser must obtain from ARIES (toll free number is 877.287.8634) a Returned Goods Authorization (RGA) number in order to return any damaged Product to ARIES for inspection and evaluation under this limited warranty.
2. The Purchaser must pay all handling charges and shipping costs to deliver Products to ARIES and must send the damaged Product along with the RGA number and proof of purchase to ARIES at 6208 Industrial Drive, Eau Claire, Wisconsin 54701.
3. Upon receipt of damaged Product, ARIES will determine whether the damaged Product is covered under the limited warranty. If it is, ARIES will repair or replace the Product. If the Product is replaced, the Product that is originally returned by the Purchaser shall become the exclusive property of ARIES. If the returned Product is not covered under the limited warranty, ARIES will notify the Purchaser before taking any further action with regard to repair or replacement, which would be at the Purchaser's cost.

Products covered under the ARIES Automotive limited warranty and term of warranties:

| | |
|--|--|
| 3" Bull Bar, Black Carbon Steel - Three Years Limited | Jeep® Modular Bumpers, Aluminum - Five Years Limited |
| 3" Bull Bar, Polished Stainless - Limited Lifetime | Jeep® Modular Bumpers, Steel - Three Years Limited |
| 3" Round Side Bars, Black Carbon Steel - Three Years Limited | Jeep® Rocker Steps - Three Years Limited |
| 3" Round Side Bars, Polished Stainless - Limited Lifetime | Jeep® Roof Light Bar - Three Years Limited |
| 4" Big Step™ Round Side Bars - Five Years Limited | Jeep® Security Cargo Lid - Three Years Limited |
| 4" Oval Side Bars, Black Carbon Steel - Three Years Limited | Jeep® Tube Bumpers, Black Carbon Steel - Three Years Limited |
| 4" Oval Side Bars, Polished Stainless - Limited Lifetime | Jeep® Tube Bumpers, Polished Stainless - Three Years Limited |
| AeroTread™ Running Boards - Three Years Limited | Jeep® Tube Doors - Five Years Limited |
| Grille Guard, Black Carbon Steel - Three Years Limited | Pro Series™ Products - Three Years Limited |
| Jeep® Fender Flares - Three Years Limited | Removable Universal Mud Flaps - One Year Limited |
| Jeep® Fender Flare Side Markers - One Year Limited | All Other Accessories - One Year Limited |

ARIES Automotive technical support line: 844.278.4357

ARIES Automotive is here to help you with any questions regarding the following:

Product installation • Product orientation • Trouble-shooting

Our knowledgeable staff is available Monday through Friday 8:00am - 7:00pm (CST)

If you wish to place an order or you have questions about your account, call 877.287.8634 for our customer service department.



WAREHOUSE LOCATIONS

ARIES HEADQUARTERS - DALLAS AREA

| | | | |
|-----------|--------------|-----|--------------|
| TOLL FREE | 888.635.9824 | FAX | 972.352.2617 |
| LOCAL | 972.456.0222 | | |

PHYSICAL ADDRESS

2611 REGENT BOULEVARD
SUITE 300
DFW AIRPORT, TX 75261

MAILING ADDRESS

PO BOX 1598
GRAPEVINE, TX 76051

ATLANTA AREA

| | |
|-----------|--------------|
| TOLL FREE | 866.528.2878 |
| LOCAL | 770.966.1829 |
| FAX | 866.529.2878 |

110 NORTHPOINT PARKWAY
SUITE 200
ACWORTH, GA 30102

EDMONTON AREA

| | |
|-----------|--------------|
| TOLL FREE | 877.287.8634 |
| FAX | 715.831.8712 |

12820 184TH STREET N.W.
EDMONTON, ALBERTA T5V 1T4

SEATTLE AREA

| | |
|-----------|--------------|
| TOLL FREE | 877.832.2370 |
| LOCAL | 253.804.3510 |
| FAX | 253.804.3511 |

2108 'B' STREET NW
SUITE 120
AUBURN, WA 98001

TORONTO AREA

| | |
|-----------|--------------|
| TOLL FREE | 877.287.8634 |
| FAX | 715.831.8712 |

317 RUTHERFORD ROAD SOUTH
UNIT A
BRAMPTON, ONTARIO L6W 3R5

CALL US TOLL-FREE
888.800.2743

VISIT US ONLINE
ARIESAUTOMOTIVE.COM

CONNECT WITH US!

