

Welch Allyn 12500

Binocular Indirect Ophthalmoscope Power Source

OWNER'S MANUAL

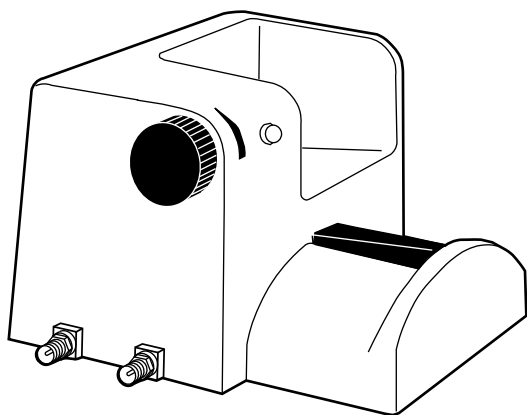

Welch Allyn®

CE

Thank you for purchasing a Welch Allyn power source for use with the Welch Allyn 12500 Binocular Indirect Ophthalmoscope (BIO). The operating instructions found in this manual should be followed to ensure many years of accurate and reliable service. Please read these instructions carefully before using your power source.

NOTE: *If you plan to connect the Welch Allyn 12500 BIO to a transformer within an instrument stand or console, please review the directions for connecting the instrument to a power source in the BIO Instruction Manual, Part No. 120073.*



U.S. Patent No. 5,394,201 and International Patents Pending

1. Wall/Desk Power Source

The Welch Allyn No. 74250 Wall/Desk Power Source is designed with versatility in mind. There are several mounting options.

1. Wall mount
2. Desk top mount
3. Desk edge mount

Features of the Wall/Desk Power Source include:

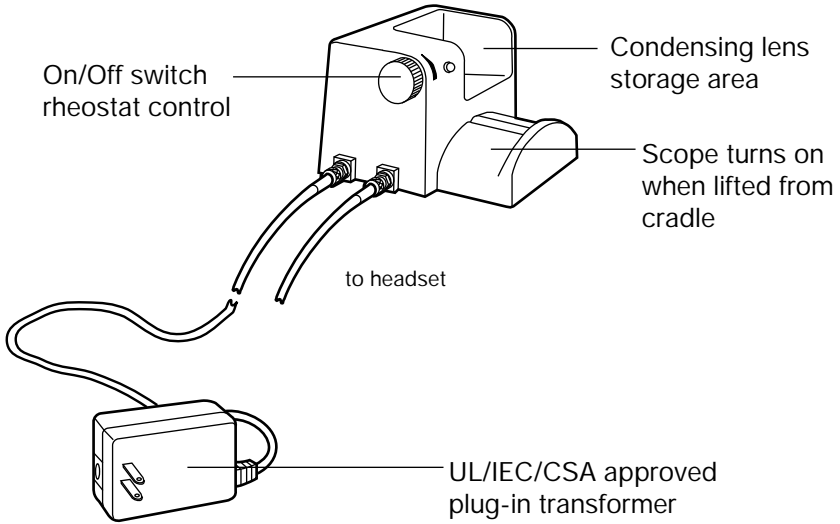

Wall Mounting

Fasten the mounting plate to the wall with the appropriate screws (wood screws are provided). Flat side of the plate should be facing the wall, long sides should be horizontal. When the screws are tightened, there will be a gap between the screw head and the surface of the plate.

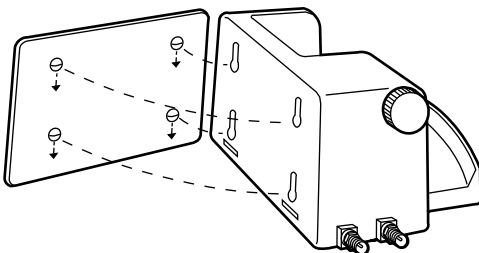

Mount the Wall/Desk bracket by fitting round holes in back plate over screw heads, then pushing downward on case. This slides the tapered slots in the back over the shoulders in the mounting plate.

Desk Top Usage

The Welch Allyn Wall/Desk Power Source can be set on any flat surface. To prevent scratching and sliding, the small rubber pads should be attached to the bottom of the unit. Remove the pads from their backing and place them on the outermost corners of the unit's base.

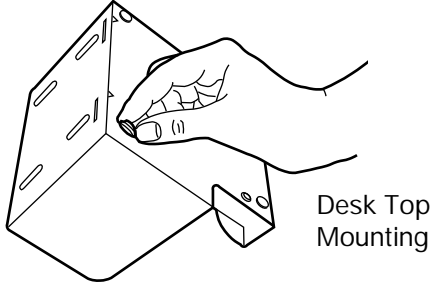

Desk Edge Mounting

NOTE: Do not use rubber pads if mounting to the EDGE of a desk or table.

The Welch Allyn Wall/Desk Power Source can also be mounted on the edge of a desk or cabinet. This will allow the Binocular Indirect Ophthalmoscope (BIO) to hang unobtrusively, close to your task area. To mount the Wall/Desk bracket on the edge of a desk or cabinet, it must be secure so the weight of the BIO does not tip it over. To secure the unit to the desk top, apply the two-sided tape found in the accessory bag to the back edge of the base of the Wall/Desk bracket.

NOTE: Make sure the surface is clean before attaching. Locate the bracket so the cradle is hanging over the edge of the desk. When the bracket is in the desired position, apply firm pressure to it so it becomes properly and evenly seated.

NOTE: If the Wall/Desk bracket ever needs to be relocated, it can be removed by prying up on one end. Any tape residue can be removed with an alcohol wipe.

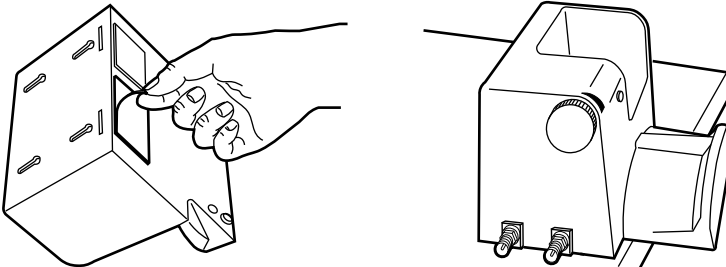

Desk Edge Mounting

Operation

Once the Wall/Desk bracket is mounted, the unit is ready for use. Plug the Power Source into an appropriately-grounded outlet. Then plug the cord from the Power Source into the receptacle labeled “in” on the Wall/Desk bracket. To complete the connection, screw the external sleeve down until it stops — this will secure the plug in place. The cord from the BIO should be connected to the “out” receptacle in the same manner that the power source is connected. Be sure to complete the connection by screwing the external plug sleeve down until it stops.

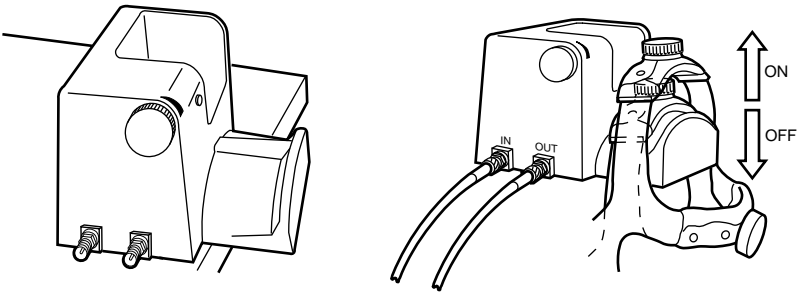

When the BIO is in the cradle of the Wall/Desk bracket, the unit is always off and the Light Emitting Diode (LED) on the front of the unit is turned off. When lifted from the cradle (with on/off rheostat in on position), power to the BIO is on and the LED will illuminate. The rheostat control/on-off switch controls power to the instrument as well as illumination intensity.

Cleaning

All surfaces may be cleaned with a soft cloth moistened with alcohol.

Maintenance

Periodic technical inspections should be performed by qualified personnel. This equipment should be inspected at least once every six months, more often if used under adverse conditions.

2. Portable Power Source

The Welch Allyn No. 74260 Portable Power Source provides complete portability and ease of use.

Features of the Portable Power Source are:

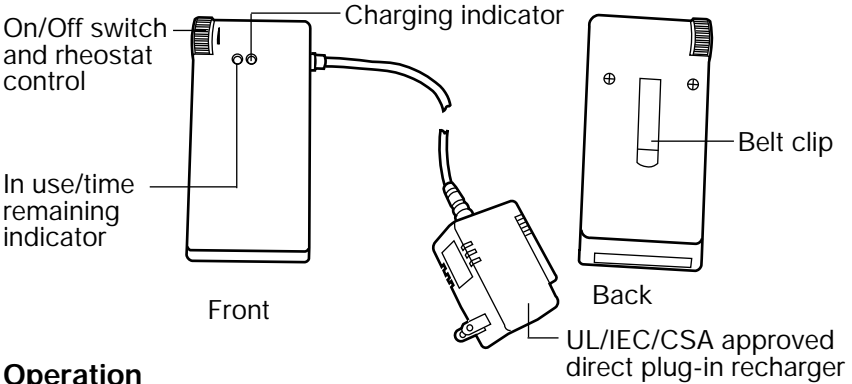

Operation

When fully charged and operated at full intensity, the Portable Power Source has approximately fifty minutes of on-time. When the BIO is used at half intensity, the on-time is approximately seventy-five minutes.

To recharge the Portable Power Source, plug the recharger into the appropriate outlet and into the proper receptacle on the battery pack. When the battery pack is recharging, the charge indicator will glow yellow. The battery cannot be overcharged.

NOTE: Be sure the on/off switch-rheostat control is turned OFF during recharging. Do not attempt to plug the recharging cord into the same receptacle the BIO cord plugs into.

To use the battery pack, plug the BIO cord into the proper receptacle. The external sleeve on the plug needs to be screwed down tightly to ensure a non-interrupted connection. Turn on the on/off switch-rheostat control and adjust to the desired intensity. When the battery pack is on, the power indicator will turn green. When approximately four to seven minutes of ON-time remain, this indicator will change to amber.

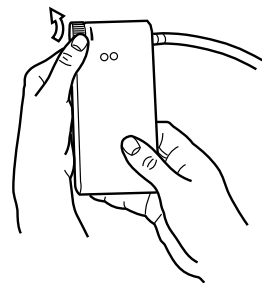
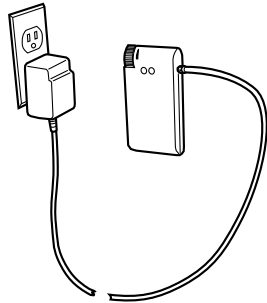

To Change the Battery

Unscrew the two screws which hold the housings together. Be certain not to touch the green circuit board or any of the components on it. Disconnect the old battery pack from the connector and attach a new battery pack. Install the battery pack with label facing you, as shown. Be sure the battery pack connector and wire lies across the *bottom* edge of the housing, as shown. Use only Welch Allyn No. 72240 rechargeable battery pack.

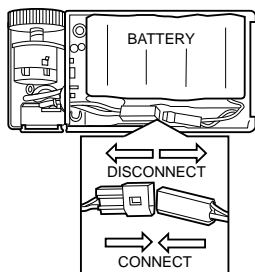
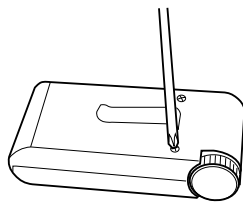

Cleaning

All external surfaces may be cleaned with a soft cloth moistened with alcohol.

Symbol Descriptions



Attention. Read Operating Manual for Cautions and Instructions for Use.



TYPE B Equipment.



TYPE BF Equipment.



Double Insulation.



Indoor Use Only.



Licensed under TÜV to conform with IEC 601-1.



Recognized component UL 2601-1.



Internally Powered.



The CE mark on this product indicates it has been tested to and conforms with the provisions noted within the 93/42/EEC Medical Device Directive.

Authorized European Representative Address:

European Regulatory Manager
Welch Allyn, Ltd.

Kells Road, Navan,
County Meath, Republic of Ireland

Tel. 353 46 28122
Fax 353 46 28536

Specifications No. 74260

Portable Power Source

Power Pack:

<i>Model Number:</i>	74201
<i>Output Voltage:</i>	4.8 Vdc
<i>Output Current:</i>	2.55 A
<i>On-time:</i>	42-50 minutes @ high setting. On-time not to exceed 10 minutes, off-time not less than 15 minutes.
<i>Low Voltage Indication Time:</i>	4-7 minutes
<i>Recharge Time:</i>	10 hrs minimum
<i>Recharge Current:</i>	225 ± 50 mA
<i>Approvals for:</i>	UL-2601-1, CAN/CSA C22.2 No. 601.1, IEC 601-1, IEC 601-1-2, CE

Charger:

<i>Model Number:</i>	74280
<i>Input:</i>	95-130 Vac, 60 Hz 0.08 A @ 120 Vac, 60 Hz
<i>Output:</i>	5.3 Vdc, 0.24 A @ 120 Vac
<i>Output Cable:</i>	SPT, 2 conductor, AWG #22
<i>Approvals for:</i>	UL-2601-1, CAN/CSA C22.2 No. 601.1, IEC 601-1, IEC 601-1-2, CE

Rechargeable Battery:

<i>Model Number:</i>	72240
<i>Type of Cells:</i>	Nickel-cadmium battery (NiCad)
<i>Nominal Voltage:</i>	4.8 Vdc, 1.8 Ahr.
<i>Approvals for:</i>	UL-2601-1, CAN/CSA C22.2 No. 601.1, IEC 601-1, IEC 601-1-2, CE

Specifications No. 74250

Wall/Desk Power Source

Plug-In Power Transformer:

<i>Model Number:</i>	74290
<i>Input:</i>	95-130 Vac, 60 Hz 0.18 A @ 120 Vac, 60 Hz
<i>Output:</i>	5.15 Vac, 2.60 A @ 120 Vac
<i>Output Cable:</i>	SJT/SVT, 2-conductor, AWG #18
<i>Approvals for:</i>	UL-2601-1, CAN/CSA C22.2 No. 601.1, IEC 601-1, IEC 601-1-2, CE

Wall/Desk Bracket:

<i>Model Number:</i>	74241
<i>Input:</i>	5.15 Vac, 60 Hz, 2.60 A
<i>Output at Output Jack:</i>	4.8 Vac, 2.55 A
<i>Approvals for:</i>	UL-2601-1, CAN/CSA C22.2 No. 601.1, IEC 601-1, IEC 601-1-2, CE

Service and Warranty Information

Service

For customers in North America, please return instruments requiring service to a Welch Allyn Technical Service Department listed below or to an authorized Welch Allyn distributor.

Technical Service Department

Welch Allyn, Inc.
4341 State Street Road
Skaneateles Falls, NY 13153-0220
U.S.A.
Telephone: 800-669-9771
Fax: 315-685-4653

For customers outside of North America, return your unit to a local, authorized Welch Allyn distributor or to your nearest Welch Allyn service center.

Rechargeable Battery Warranty

Welch Allyn nickel-cadmium batteries are guaranteed by Welch Allyn for two years from date of manufacture (when used in Welch Allyn instruments only). Defective batteries will be replaced on a pro rata basis should failure occur prior to expiration date on battery.





Welch Allyn, Inc.
4341 State Street Road
P.O. Box 220
Skaneateles Falls, NY 13153-0220
Telephone: 315-685-4560
1-800-535-6663 (only in U.S.A.)
FAX: 315-685-3361